

HiPerFET™ Power MOSFETs Q-Class

IXFE 44N50Q
IXFE 48N50Q

V_{DSS}	I_{D25}	$R_{DS(on)}$
500 V	39 A	120 mΩ
500 V	41 A	110 mΩ

$t_{rr} \leq 250$ ns

N-Channel Enhancement Mode
Avalanche Rated, Low Q_g , High dv/dt

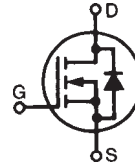

Preliminary data sheet

ISOPLUS 227™ (IXFE)

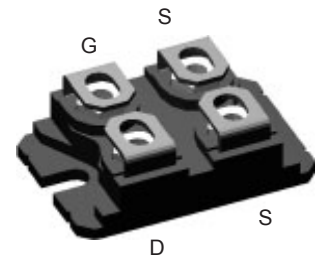

G = Gate D = Drain
S = Source

Either Source terminal at miniBLOC can be used as Main or Kelvin Source

Symbol	Test Conditions	Maximum Ratings	
V_{DSS}	$T_J = 25^\circ\text{C}$ to 150°C	500	V
V_{DGR}	$T_J = 25^\circ\text{C}$ to 150°C ; $R_{GS} = 1\text{ M}\Omega$	500	V
V_{GS}	Continuous	± 20	V
V_{GSM}	Transient	± 30	V
I_{D25}	$T_C = 25^\circ\text{C}$	44N50Q 39 48N50Q 41	A
I_{DM}	$T_C = 25^\circ\text{C}$, pulse width limited by T_{JM}	44N50Q 176 48N50Q 192	A
I_{AR}	$T_C = 25^\circ\text{C}$	48	A
E_{AR} E_{AS}	$T_C = 25^\circ\text{C}$	60 2.5	mJ mJ
dv/dt	$I_S \leq I_{DM}$, $di/dt \leq 100\text{ A}/\mu\text{s}$, $V_{DD} \leq V_{DSS}$, $T_J \leq 150^\circ\text{C}$, $R_G = 2\ \Omega$	15	V/ns
P_D	$T_C = 25^\circ\text{C}$	400	W
T_J		-40 to +150	$^\circ\text{C}$
T_{JM}		150	$^\circ\text{C}$
T_{stg}		-40 to +150	$^\circ\text{C}$
V_{ISOL}	50/60 Hz, RMS $t = 1$ min $I_{ISOL} \leq 1$ mA $t = 1$ s	2500 3000	V~ V~
M_d	Mounting torque Terminal connection torque	1.5/13 1.5/13	Nm/lb.in. Nm/lb.in.
Weight		19	g

Features

- Conforms to SOT-227B outline
- Low $R_{DS(on)}$ HDMOS™ process
- Rugged polysilicon gate cell structure
- Unclamped Inductive Switching (UIS) rated
- Low package inductance
- Fast intrinsic Rectifier

Applications

- DC-DC converters
- Battery chargers
- Switched-mode and resonant-mode power supplies
- DC choppers
- Temperature and lighting controls

Advantages

- Low cost
- Easy to mount
- Space savings
- High power density

Symbol	Test Conditions	Characteristic Values ($T_J = 25^\circ\text{C}$, unless otherwise specified)		
		min.	typ.	max.
V_{DSS}	$V_{GS} = 0\text{ V}$, $I_D = 1\text{ mA}$	500		V
$V_{GS(th)}$	$V_{DS} = V_{GS}$, $I_D = 4\text{ mA}$	2.0		V
I_{GSS}	$V_{GS} = \pm 20\text{ V}_{DC}$, $V_{DS} = 0$			± 100 nA
I_{DSS}	$V_{DS} = V_{DSS}$, $V_{GS} = 0\text{ V}$		$T_J = 25^\circ\text{C}$ $T_J = 125^\circ\text{C}$	100 μA 2 mA
$R_{DS(on)}$	$V_{GS} = 10\text{ V}$, $I_D = I_T$		44N50Q 48N50Q	120 mΩ 110 mΩ
	Notes 1, 2			

Symbol	Test Conditions	Characteristic Values ($T_J = 25^\circ\text{C}$, unless otherwise specified)		
		min.	typ.	max.
g_{fs}	$V_{DS} = 20\text{ V}; I_D = I_T$, Notes 1, 2	30	42	S
C_{iss}	$V_{GS} = 0\text{ V}, V_{DS} = 25\text{ V}, f = 1\text{ MHz}$		7000	pF
C_{oss}			960	pF
C_{rss}			230	pF
$t_{d(on)}$	$V_{GS} = 10\text{ V}, V_{DS} = 0.5 \cdot V_{DSS}, I_D = I_T$ $R_G = 4.7\ \Omega$ (External),		33	ns
t_r			22	ns
$t_{d(off)}$			75	ns
t_f			10	ns
$Q_{g(on)}$	$V_{GS} = 10\text{ V}, V_{DS} = 0.5 \cdot V_{DSS}, I_D = I_T$		190	nC
Q_{gs}			40	nC
Q_{gd}			86	nC
R_{thJC}			0.31	K/W
R_{thCK}			0.07	K/W

Symbol	Test Conditions	Characteristic Values ($T_J = 25^\circ\text{C}$, unless otherwise specified)		
		min.	typ.	max.
I_s	$V_{GS} = 0\text{ V}$			48 A
I_{SM}	Repetitive; pulse width limited by T_{JM}			192 A
V_{SD}	$I_F = I_S, V_{GS} = 0\text{ V}$, Note:1			1.5 V
t_{rr}	$I_F = 25\text{ A}, -di/dt = 100\text{ A}/\mu\text{s}, V_R = 100\text{ V}$		1.0	250 ns
Q_{RM}			10	μC
I_{RM}				A

ISOPLUS-227 B

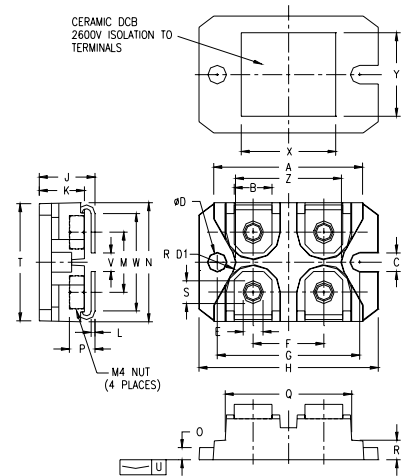

SYM	INCHES		MILLIMETERS	
	MIN	MAX	MIN	MAX
A	1.240	1.270	31.50	32.26
B	.310	.330	7.87	8.38
C	.155	.165	3.94	4.19
D	.155	.165	3.94	4.19
D1	.150	.157	3.81	3.98
E	.160	.168	4.06	4.27
F	.587	.595	14.91	15.11
G	1.186	1.193	30.12	30.30
H	1.489	1.505	37.80	38.23
J	.465	.481	11.81	12.22
K	.370	.380	9.40	9.65
L	.030	.033	0.76	0.84
M	.496	.506	12.60	12.85
N	.990	1.001	25.15	25.42
O	.100	.105	2.54	2.67
P	.195	.235	4.95	5.97
Q	1.045	1.059	26.54	26.90
R	.160	.170	4.06	4.32
S	.186	.191	4.72	4.85
T	.968	.987	24.59	25.07
U	-.001	.002	-0.03	0.05
V	.130	.160	3.30	4.06
W	.780	.830	19.81	21.08
X	.770	.810	19.56	20.57
Y	.680	.720	17.27	18.29
Z	.885	.892	22.48	22.66

- Note: 1. Pulse test, $t \leq 300\ \mu\text{s}$, duty cycle $d \leq 2\%$
 2. I_T Test current:
 44N50Q: $I_T = 22\text{ A}$
 48N50Q: $I_T = 24\text{ A}$

IXYS reserves the right to change limits, test conditions, and dimensions.

**Fig. 1. Output Characteristics
@ 25 Deg. C**

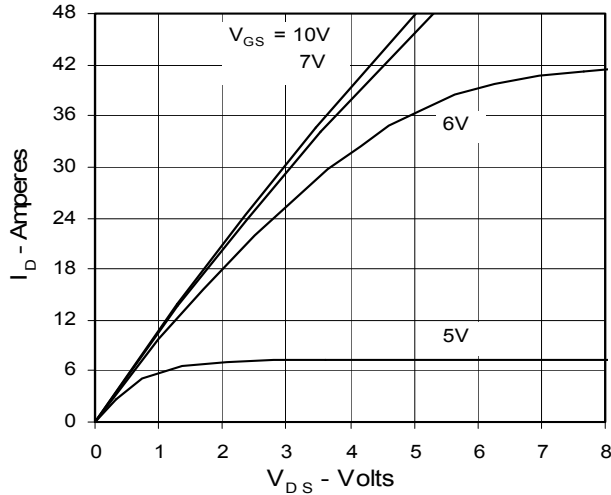

**Fig. 2. Extended Output Characteristics
@ 25 deg. C**

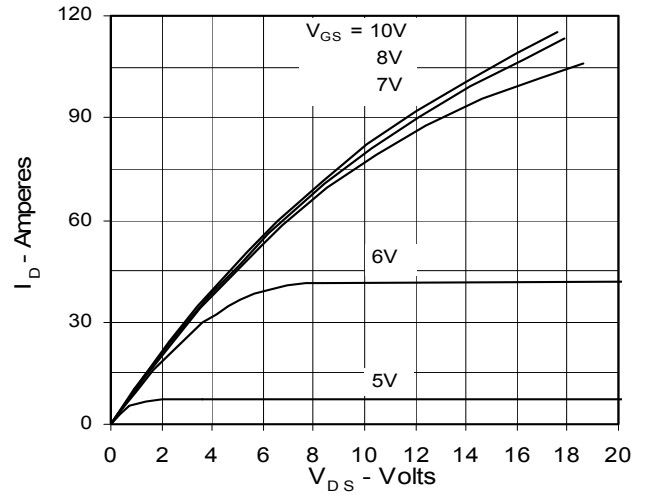

**Fig. 3. Output Characteristics
@ 125 Deg. C**

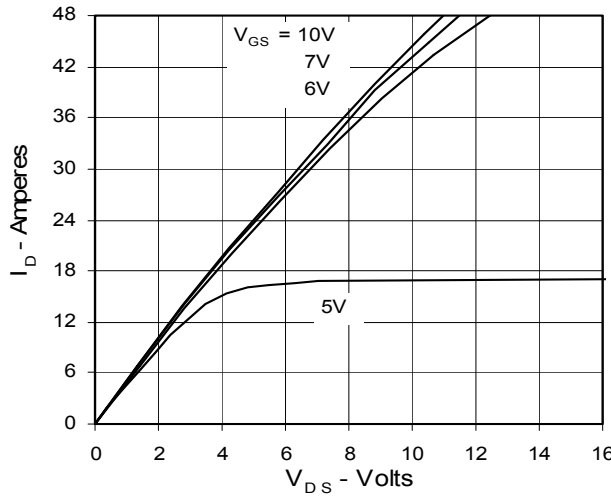

**Fig. 4. $R_{DS(on)}$ Normalized to I_{D25} Value vs.
Junction Temperature**

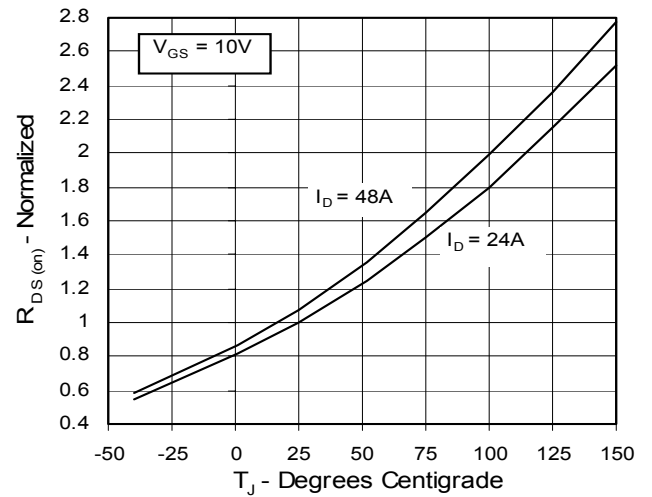

**Fig. 5. $R_{DS(on)}$ Normalized to I_{D25}
Value vs. I_D**

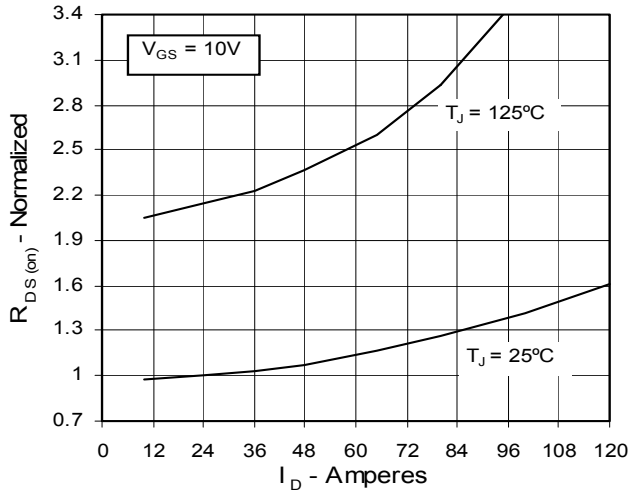

**Fig. 6. Drain Current vs. Case
Temperature**

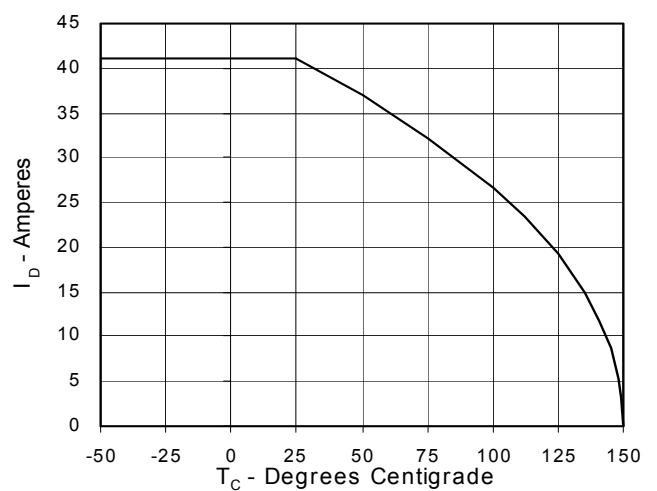

Fig. 7. Input Admittance

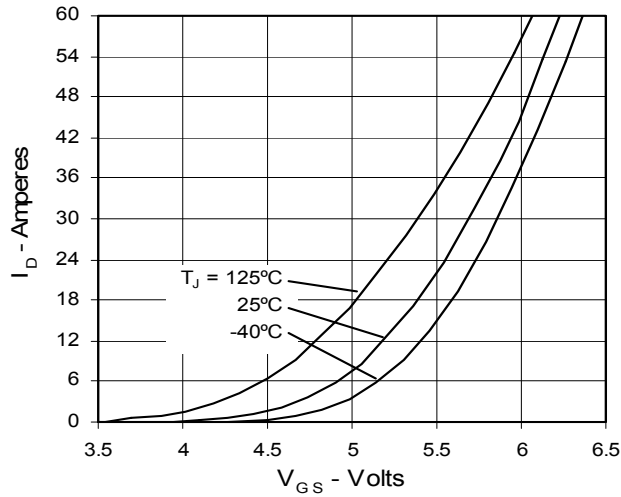

Fig. 8. Transconductance

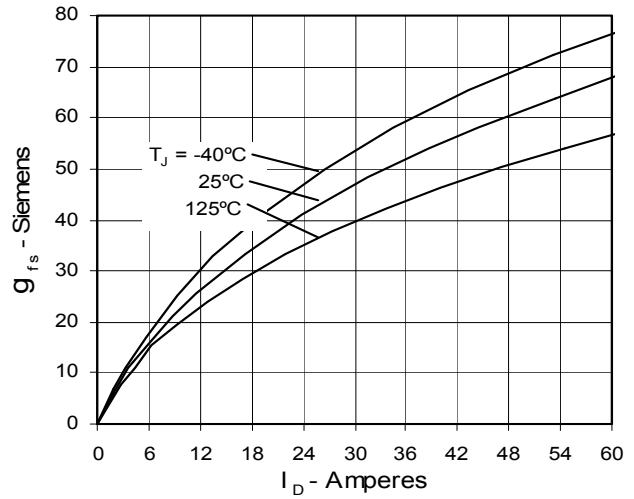

Fig. 9. Source Current vs. Source-To-Drain Voltage

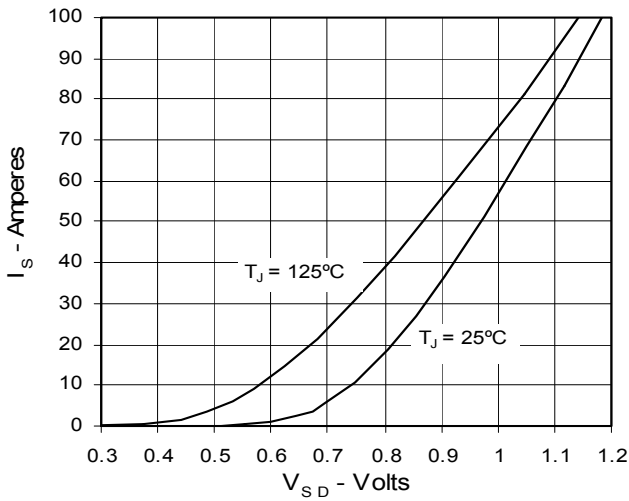

Fig. 10. Gate Charge

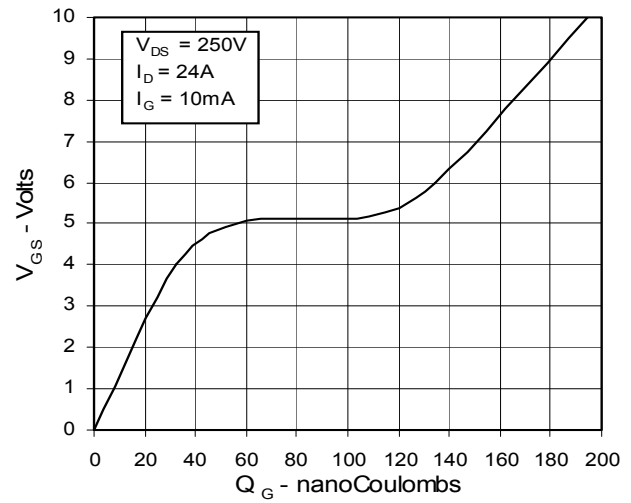

Fig. 11. Capacitance

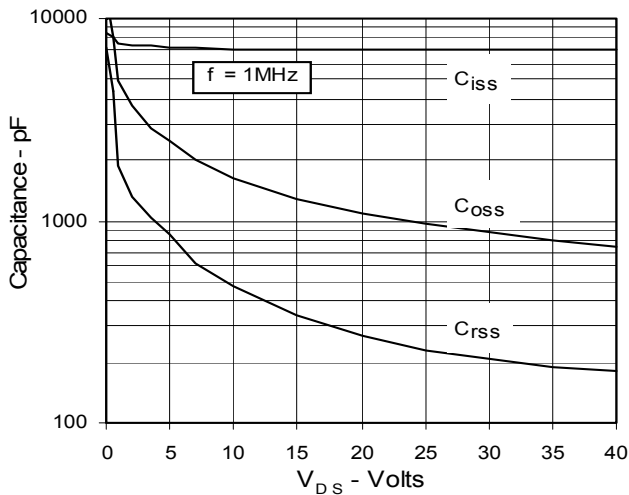
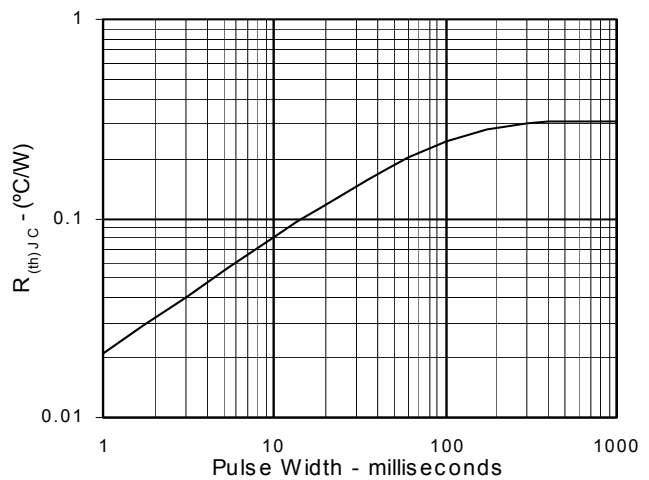

Fig. 12. Maximum Transient Thermal Resistance



IXYS reserves the right to change limits, test conditions, and dimensions.

IXYS MOSFETs and IGBTs are covered by one or more of the following U.S. patents:

4,835,592 4,881,106 5,017,508 5,049,961 5,187,117 5,486,715 6,306,728B1 6,259,123B1 6,306,728B1
4,850,072 4,931,844 5,034,796 5,063,307 5,237,481 5,381,025 6,404,065B1 6,162,665 6,534,343

Mouser Electronics

Authorized Distributor

Click to View Pricing, Inventory, Delivery & Lifecycle Information:

[IXYS:](#)

[IXFE48N50Q](#) [IXFE44N50Q](#)



Компания «ЭлектроПласт» предлагает заключение долгосрочных отношений при поставках импортных электронных компонентов на взаимовыгодных условиях!

Наши преимущества:

- Оперативные поставки широкого спектра электронных компонентов отечественного и импортного производства напрямую от производителей и с крупнейших мировых складов;
- Поставка более 17-ти миллионов наименований электронных компонентов;
- Поставка сложных, дефицитных, либо снятых с производства позиций;
- Оперативные сроки поставки под заказ (от 5 рабочих дней);
- Экспресс доставка в любую точку России;
- Техническая поддержка проекта, помощь в подборе аналогов, поставка прототипов;
- Система менеджмента качества сертифицирована по Международному стандарту ISO 9001;
- Лицензия ФСБ на осуществление работ с использованием сведений, составляющих государственную тайну;
- Поставка специализированных компонентов (Xilinx, Altera, Analog Devices, Intersil, Interpoint, Microsemi, Aeroflex, Peregrine, Syfer, Eurofarad, Texas Instrument, Miteq, Cobham, E2V, MA-COM, Hittite, Mini-Circuits, General Dynamics и др.);

Помимо этого, одним из направлений компании «ЭлектроПласт» является направление «Источники питания». Мы предлагаем Вам помощь Конструкторского отдела:

- Подбор оптимального решения, техническое обоснование при выборе компонента;
- Подбор аналогов;
- Консультации по применению компонента;
- Поставка образцов и прототипов;
- Техническая поддержка проекта;
- Защита от снятия компонента с производства.



Как с нами связаться

Телефон: 8 (812) 309 58 32 (многоканальный)

Факс: 8 (812) 320-02-42

Электронная почта: org@eplast1.ru

Адрес: 198099, г. Санкт-Петербург, ул. Калинина, дом 2, корпус 4, литера А.