



ON Semiconductor®

<http://onsemi.com>

LA4814JA

Monolithic Linear IC

2-Channel Power Amplifier

Overview

The LA4814JA built-in the power amplifier circuit capable of low-voltage (2.7V and up) operation and has additionally a standby function to reduce the current drain. It is a power amplifier IC optimal for speaker drive used in battery-driven portable equipment and other such products.

Applications

Mini radio cassette players/recorders, portable radios, transceivers and other portable audio devices

Features

- On-chip 2-channel power amplifier
 - Output power 1 = 350mW typ. ($V_{CC} = 5.0V$, $R_L = 4\Omega$, THD = 10%)
 - Output power 2 = 150mW typ. ($V_{CC} = 3.6V$, $R_L = 4\Omega$, THD = 10%)
- Enables monaural BTL output system by changing externally connected components
 - Output power 3 = 700mW typ. ($V_{CC} = 5.0V$, $R_L = 8\Omega$, THD = 10%)
 - Output power 4 = 320mW typ. ($V_{CC} = 3.6V$, $R_L = 8\Omega$, THD = 10%)
- Low-voltage operation possible
 - $V_{CC} = 2.7V$ and up
- Standby function
 - Current drain at standby = 0.1 μ A typ. ($V_{CC} = 5V$)
- Voltage gain setting possible
 - Voltage gain = 3 to 20dB
- Second amplifier stop control function
 - Reducing the pop noise at startup (in BTL mode)

LA4814JA

Specifications

Maximum Ratings at $T_a = 25^\circ\text{C}$

Parameter	Symbol	Conditions	Ratings	Unit
Maximum supply voltage	V_{CC} max		8	V
Allowable power dissipation	P_d max	*	1.3	W
Maximum junction temperature	T_j max		150	$^\circ\text{C}$
Operating temperature	T_{opr}		-40 to +85	$^\circ\text{C}$
Storage temperature	T_{stg}		-40 to +150	$^\circ\text{C}$

* Mounted on Our evaluation board : Double-sided board with dimensions of 60mm \times 60mm \times 1.6mm

Stresses exceeding Maximum Ratings may damage the device. Maximum Ratings are stress ratings only. Functional operation above the Recommended Operating Conditions is not implied. Extended exposure to stresses above the Recommended Operating Conditions may affect device reliability.

Operating Conditions at $T_a = 25^\circ\text{C}$

Parameter	Symbol	Conditions	Ratings	Unit
Recommended supply voltage	V_{CC}		5	V
Recommended load resistance	RL	Single ended mode	4 to 32	Ω
		BTL mode	8 to 32	Ω
Operating supply voltage range	V_{CC} op	Single ended mode, $R_L = 6$ to 32Ω	2.7 to 7	V
		Single ended mode, $R_L = 4$ to 6Ω	2.7 to 5.5	V
		BTL mode, $R_L = 16$ to 32Ω	2.7 to 7	V
		BTL mode, $R_L = 8$ to 16Ω	2.7 to 5.5	V

* Determine the supply voltage to be used with due consideration of allowable power dissipation.

Electrical Characteristics at $T_a = 25^\circ\text{C}$, $V_{CC} = 5.0\text{V}$, $R_L = 4\Omega$, $f_{in} = 1\text{kHz}$

Parameter	Symbol	Conditions	Ratings			Unit
			min	typ	max	
Quiescent current drain	I_{CCOP}	No signal		8.6	15	mA
Standby current drain	ISTBY	No signal, $V_8 = \text{Low}$		0.1	10	μA
Maximum output power	POMAX	THD = 10%	220	350		mW
BTL maximum output power	POMXB	BTL mode, $R_L = 8\Omega$, THD = 10%		700		mW
Voltage gain	VG	$V_{IN} = -30\text{dBV}$	8.2	9.7	11.2	dB
Voltage gain use range	VGU		3		20	dB
Channel balance	CHB	$V_{IN} = -30\text{dBV}$	-2	0	2	dB
Total harmonic distortion	THD	$V_{IN} = -30\text{dBV}$		0.35	1	%
Output noise voltage	VNOUT	$R_g = 620\Omega$, 20 to 20kHz		15	50	μVrms
Channel separation	CHSEP	$V_{OUT} = -10\text{dBV}$, 20 to 20kHz	-70	-81		dBV
Ripple rejection ratio	SVRR	$R_g = 620\Omega$, $f_r = 100\text{Hz}$, $V_r = -20\text{dBV}$		53		dB
Output DC offset voltage	VOF	$R_g = 620\Omega$, V_3 - V_{12} , in BTL mode	-30	0	30	mV
Reference voltage	VREF			2.2		V
Pin 8 control HIGH voltage	V_8H	(Power amplifier operation mode)	1.6		V_{CC}	V
Pin 8 control LOW voltage	V_8L	(Power amplifier standby mode)	0		0.3	V
Pin 9 control HIGH voltage	V_9H	(Second amplifier standby mode)	1.6		V_{CC}	V
Pin 9 control LOW voltage	V_9L	(Second amplifier operation mode)	0		0.3	V

Package Dimensions

unit : mm (typ)

3179C

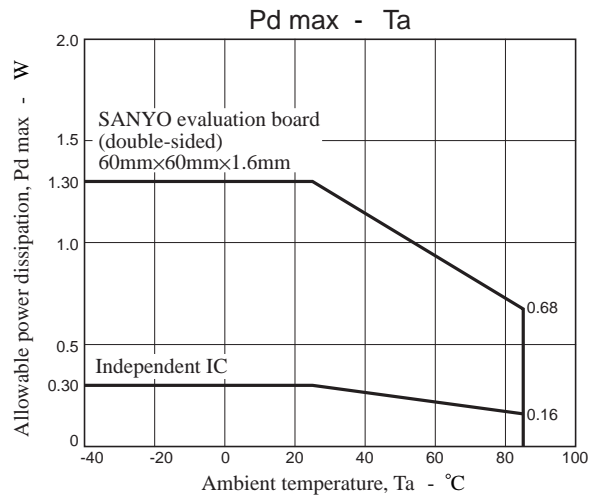
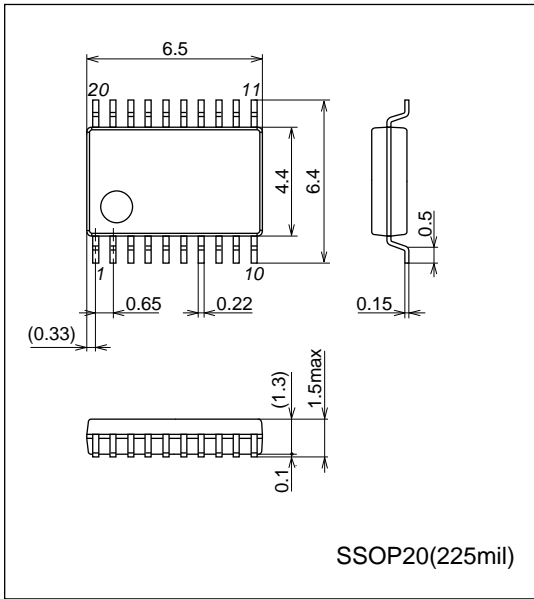

Pin Functions

Pin No.	Pin Name	Pin Voltage	Description	Equivalent Circuit
		V _{CC} = 5V		
1	NC	-	No connect	
2	NC	-	No connect	
3	NC	-	No connect	
4	GND	0	Ground pin	
5	NC	-	No connect	
6 15	OUT1 OUT2	2.2	Power amplifier output pin	
7	NC	-	No connect	

Continued on next page.

LA4814JA

Continued from preceding page.

Pin No.	Pin Name	Pin Voltage	Description	Equivalent Circuit
		$V_{CC} = 5V$		
8 13	IN1 IN2	2.2	Input pin	
9	NC	-	No connect	
10	VREF	2.2	Ripple filter pin (For connection of capacitor for filter)	
11	STBY	-	Standby pin Standby mode at 0V to 0.3V Operation mode at 1.6V to V_{CC}	
12	CNT	-	Second amplifier stop control pin Second amplifier operation at 0V to 0.3V Second amplifier stop at 1.6V to V_{CC}	
14	NC	-	No connect	
16	NC	-	No connect	
17	V_{CC}	5	Power supply pin	
18	NC	-	No connect	
19	NC	-	No connect	
20	NC	-	No connect	

LA4814JA

Block Diagram

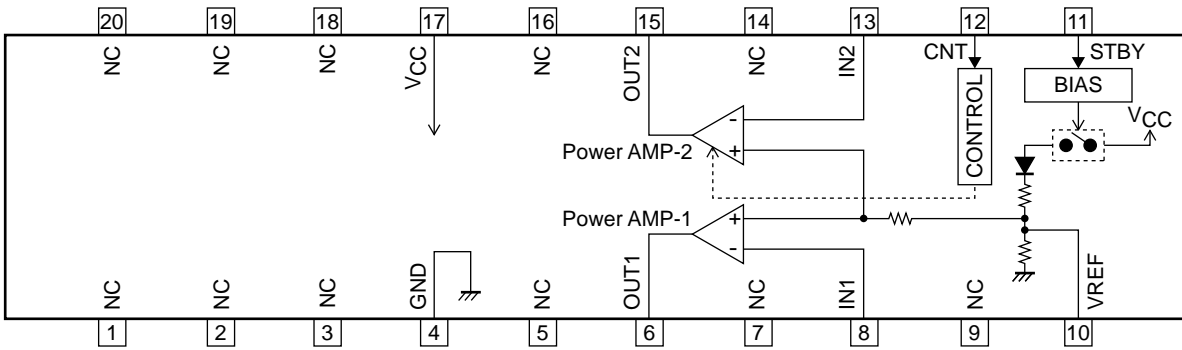

Test Circuit

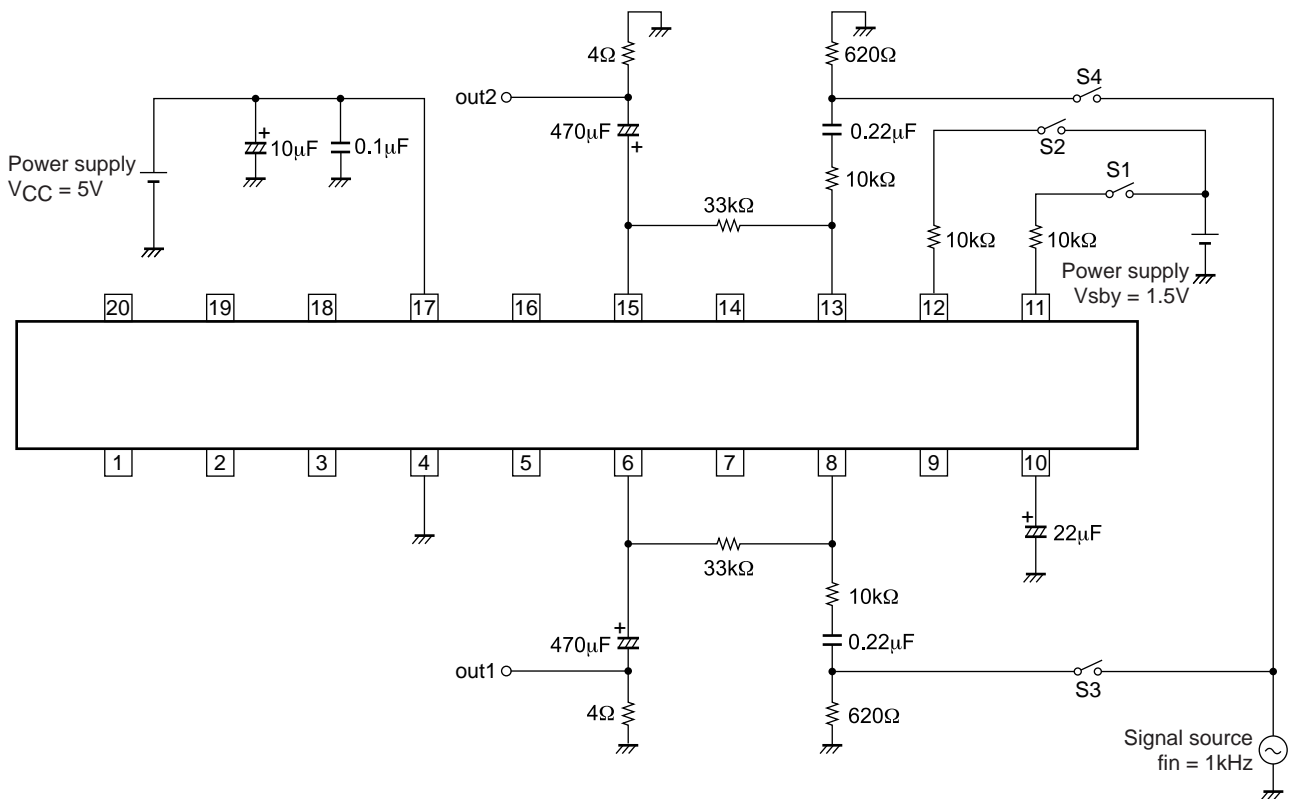

LA4814JA

Application Circuit Example 1. (2-channel single ended mode)

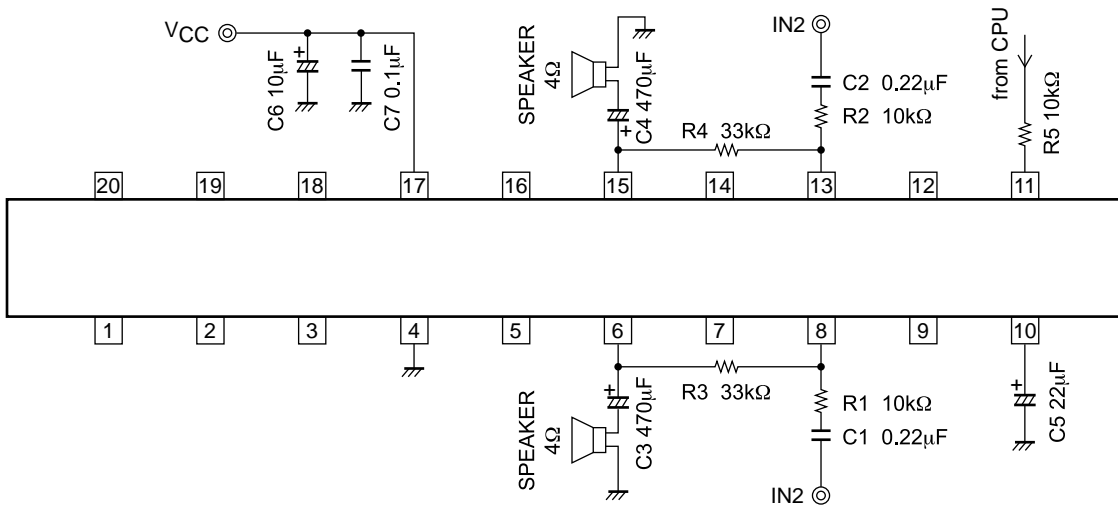

Application Circuit Example 2. (monaural BTL mode)

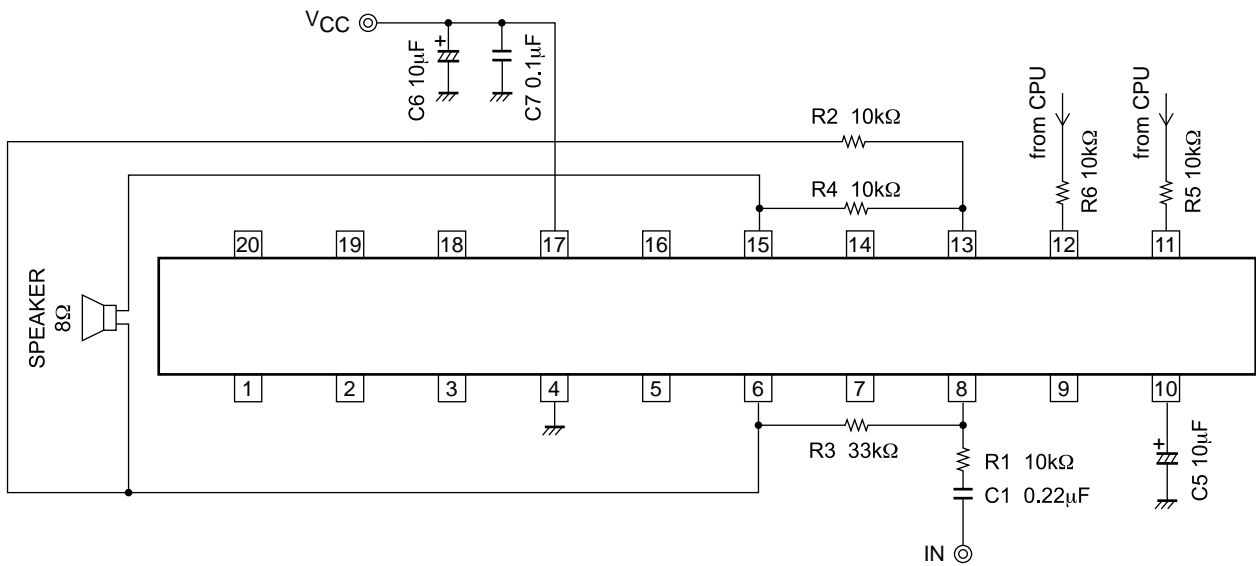

Cautions for Use

1. Input coupling capacitors (C1, C2)

C1 and C2 are input coupling capacitors that are used to cut DC voltage. However, the input coupling capacitor C1 (C2) and input resistor R1 (R2) make up the high-pass filter, attenuating the bass frequency. Therefore, the capacitance value must be selected with due consideration of the cut-off frequency.

The cut-off frequency is expressed by the following formula :

$$f_c = 1/2 \pi \times R1 \times C1 (= 1/2 \pi \times R2 \times C2)$$

Note with care that this capacitance value affects the pop noise at startup. To increase this capacitance value, it is necessary to increase the capacitance value of pin 10 capacitor (C5) to soften the startup characteristics.

2. Pin 10 capacitor (C5)

This capacitor C5 is designed for the ripple filter. Its purpose is to make up a low-pass filter with a 100kΩ internal resistor for reducing the ripple component of the power supply and improve the ripple rejection ratio.

Inside the IC, the startup characteristics of the pin 10 voltage are used to drive the automatic pop noise reduction circuit, and care must be taken with the pop noise when the C5 capacitance value is to be set lower.

However, when the IC is used in BTL mode, the automatic pop noise reduction function mentioned above has no effect. Instead, a pop noise reduction method that utilizes the second amplifier control function is used so that the capacitance value must be determined while factoring in the ripple rejection ratio or startup time.

Recommended capacitance value : Min. 22μF (in 2-channel mode)
10μF (in mono BTL mode)

3. Bypass capacitor (C7)

The purpose of the bypass capacitor C7 is to reject the high-frequency components that cannot be rejected by the power supply capacitor (chemical capacitor C6). Place the capacitor as near to the IC as possible, and use a ceramic capacitor with excellent high-frequency characteristics.

4. Standby function

The standby function serves to place the IC in standby mode to minimize the current drain.

a) When using the standby function (when using microcomputer control)

By applying the following voltages to the standby pin (pin 11), the mode changeover can be performed between standby and operation.

Operation mode ... V11 ≥ 1.6V
Standby mode ... V11 ≤ 0.3V

However, set the resistance of resistor R5 inserted in series in such a way that the condition in the following formula is met.

$$R5 \leq 24.6 \times (V_{stby} - 1.6) \text{ k}\Omega$$

The pin 11 inrush current is expressed by the following formula:

$$I_{11} = (40 \times V_{stby} - 26.3)/(1+0.04 \times R5) \mu\text{A}$$

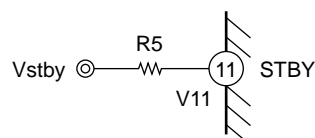

Fig. 1

b) When not using the standby function (microcomputer control is not possible)

By applying a voltage from the power supply (pin 17) to the standby pin (pin 11), the IC can be turned on without the control of the microcomputer when the power is turned on.

In order to reduce the pop noise when the IC is turned off, it is recommended that resistor R5 be inserted as shown in Fig.2. The resistance value indicated below is recommended for the inserted resistor R5.

VCC = 5.0V : R5 = 82kΩ
VCC = 3.6V : R5 = 47kΩ
VCC = 3.0V : R5 = 33kΩ

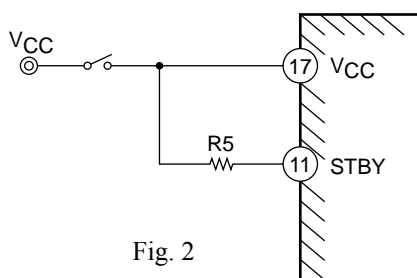

Fig. 2

LA4814JA

5. Second amplifier control function (only when BTL mode is used)

The second amplifier control function is a function to reduce the startup pop-noise in BTL mode. The pop noise can be reduced by first turning on the IC while the second amplifier is stopped, then after the potential inside the IC gets stabilized, turning on the second amplifier.

The values shown below are recommended for the control time.

C5 [μF]	2.2	3.3	4.7	10
Twu [ms]	200	250	300	500

* Twu : Time after releasing standby to second amplifier turn-on

a) When using microcomputer control

The second amplifier can be controlled by applying the following voltages to pin 12.

Second amplifier operation mode ... $V_{12} \leq 0.3V$

Second amplifier stop mode ... $V_{12} \geq 1.6V$

However, set the resistance value of the resistor R6 inserted in series in such a way that the condition in the following formula is met.

$$R6 \leq 16.2 \times (V_{cnt} - 1.6) \text{ k}\Omega$$

The pin 12 injected current is expressed by the following formula :

$$I_{12} = (57.6 \times V_{cnt} - 31.7) / (1 + 0.058 \times R6) \mu A$$

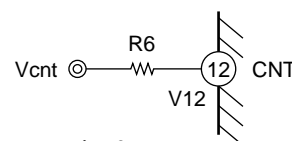

Fig. 3

b) When microcomputer control is not possible

When the microcomputer cannot be used, the second amplifier can be controlled by adding the external components as shown in Fig. 4.

	V_{CC} (V)		
	5	3.6	3
R7 (kΩ)	10	6.8	6.8
R9 (kΩ)	120	68	56
C8 (μF)	100	100	100

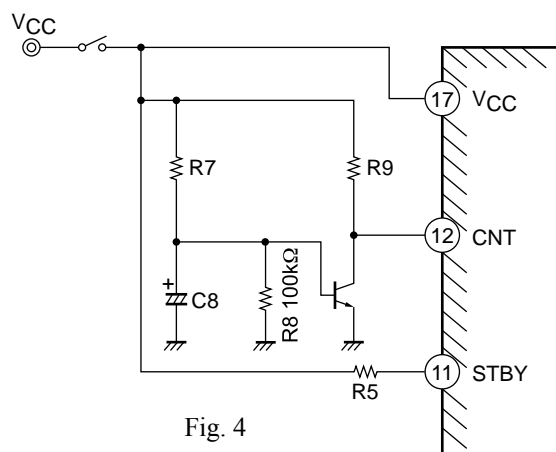

Fig. 4

6. Shorting between pins

When power is applied with pins left short-circuited, electrical deterioration or damage may result.

Therefore, check before power application if pins are short-circuited with solder, etc. during mounting of IC.

7. Load shorting

If the load is left short-circuited for a long period of time, electrical deterioration or damage may occur.

Never allow the load to short-circuit.

8. Maximum rating

When IC is used near the maximum rating, there is a possibility that the maximum rating may be exceeded even under the smallest change of conditions, resulting in failure. Take sufficient margin for variation of supply voltage and use IC within a range where the maximum rating will never be exceeded.

9. Turn-off transient response characteristics

If the IC is turned off and then turned back on while there is a potential difference between the pin 10 (reference voltage, plus input pin) and pins 8 and 15 (minus input pins), a louder pop noise than the one normally generated when power is switched on will be emitted. Therefore, in order to minimize the turn-on pop noise, smoothen the discharge of the input and output capacitors, and bring the potential of pin 10 and pins 8 and 15 to approximately the same level, then turn on the IC.

a) Single ended mode

When the continuous changeover of mode between standby and operation is necessary, it is recommended to insert a resistor between the output pins (pins 6 and 15) and ground to accelerate the turn-off transient response characteristic. The value shown below is recommended for the resistor used for discharge. In order to reduce pop noise, it is recommended that time necessary for turning the IC back on is greater than the following value.

Recommended discharge resistor : $R = 4.7k\Omega$
 (Recommended turn-on time : $T = 600ms$)

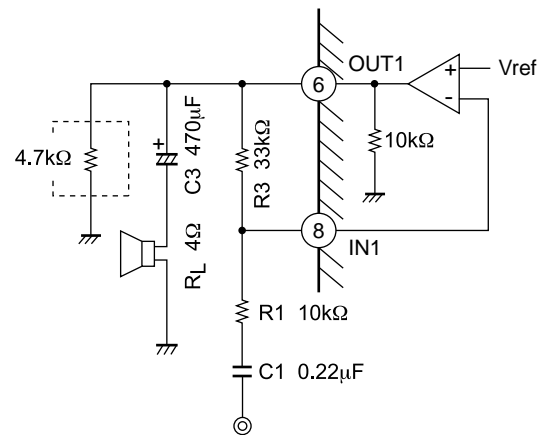
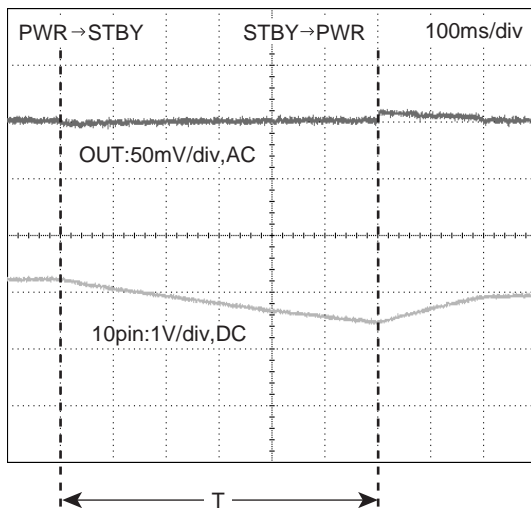

b) BTL mode

When the continuous changeover of mode between standby and operation is performed, it is recommended that the second amplifier control function be used to reduce the turn-on pop noise. If this function is used, the pop noise level can be reduced regardless of the time taken for the IC to turn on after it is turned off.

For details on the time taken for the second amplifier to turn on after the IC is turned on, refer to Section 5 “Second amplifier control function.”

General characteristics Single ended mode

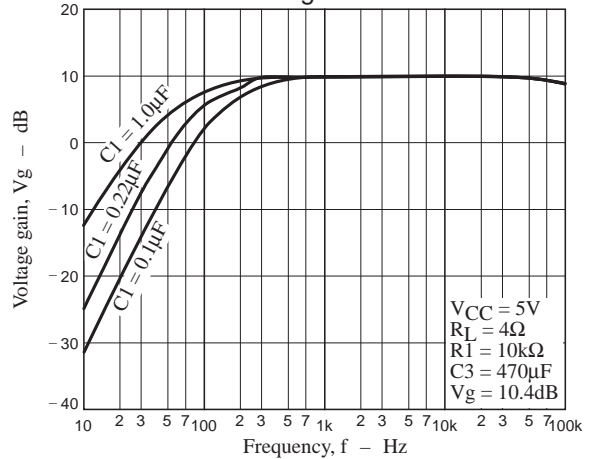
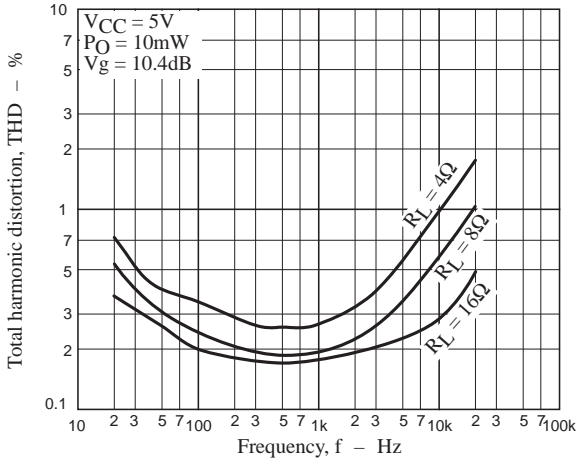
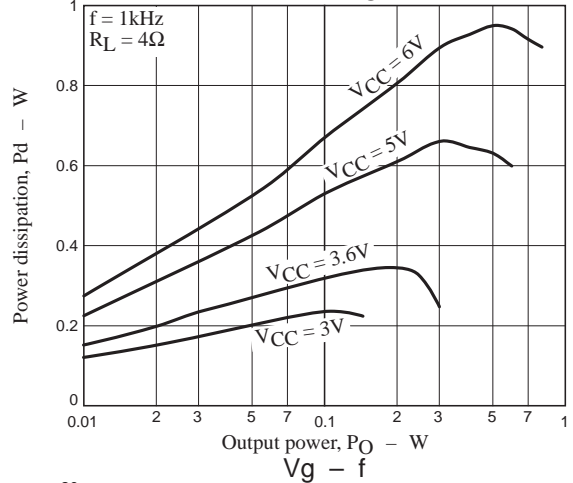
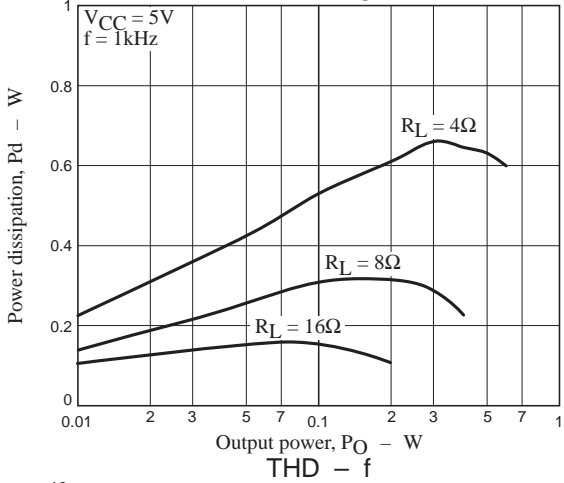
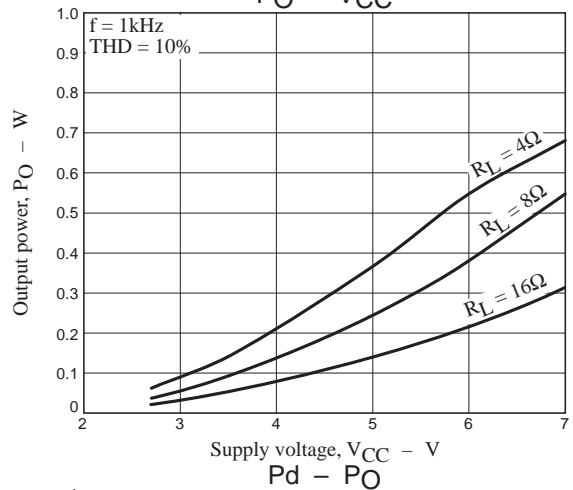
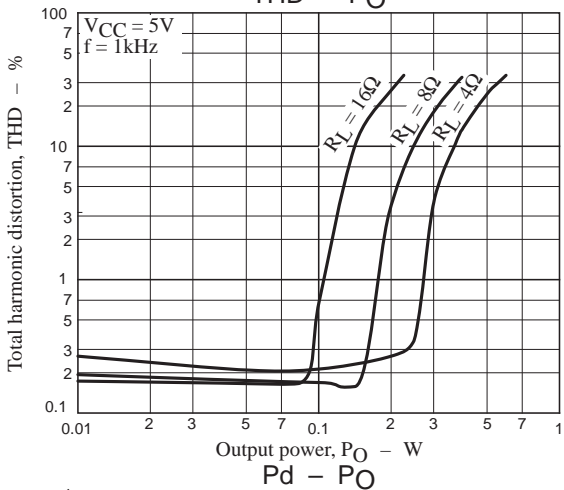
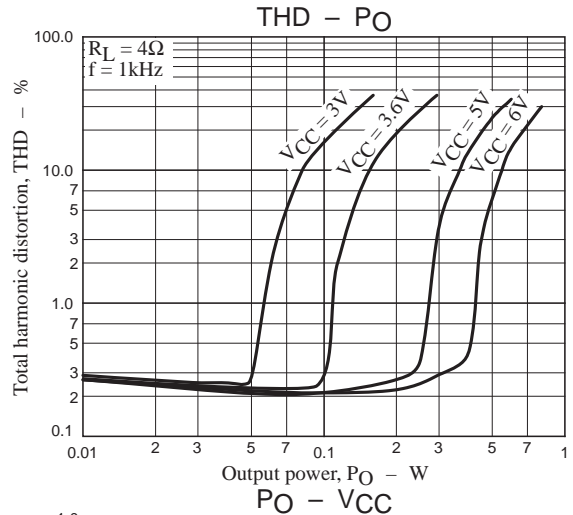
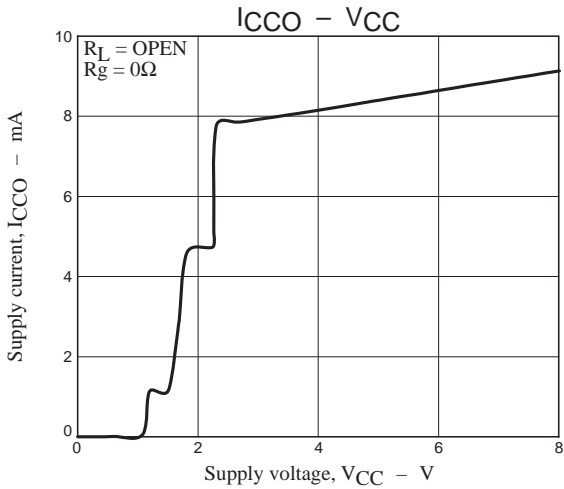

LA4814JA

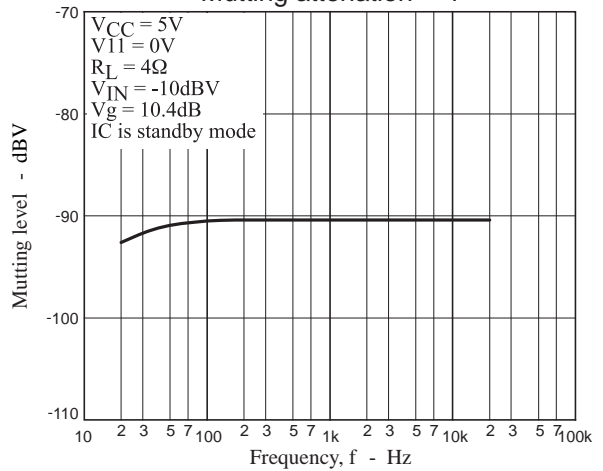
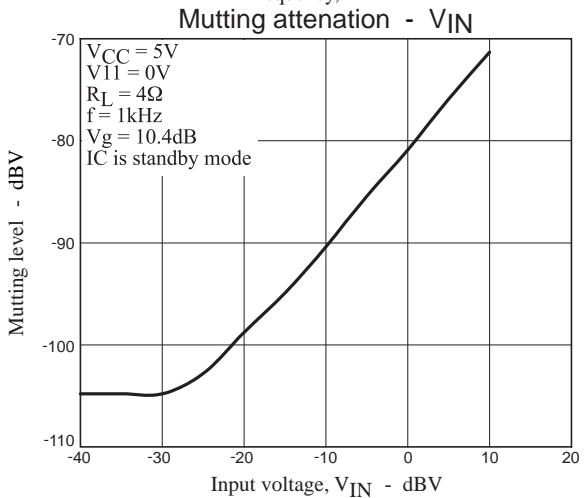
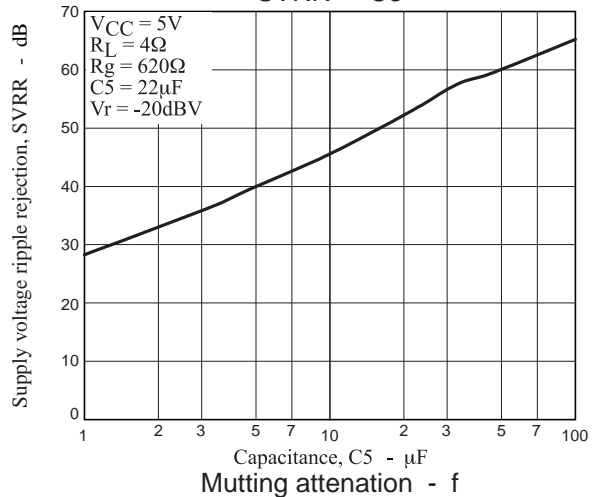
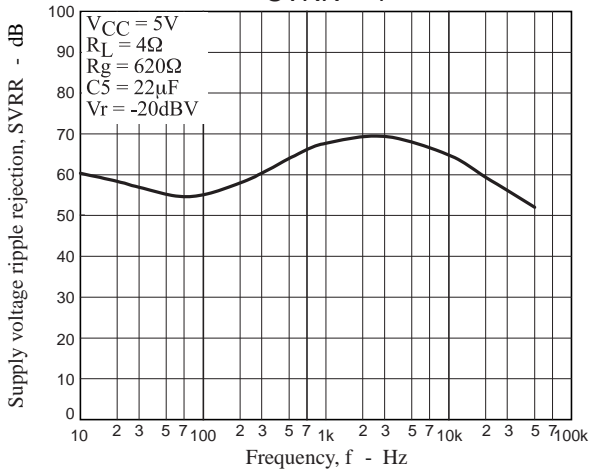
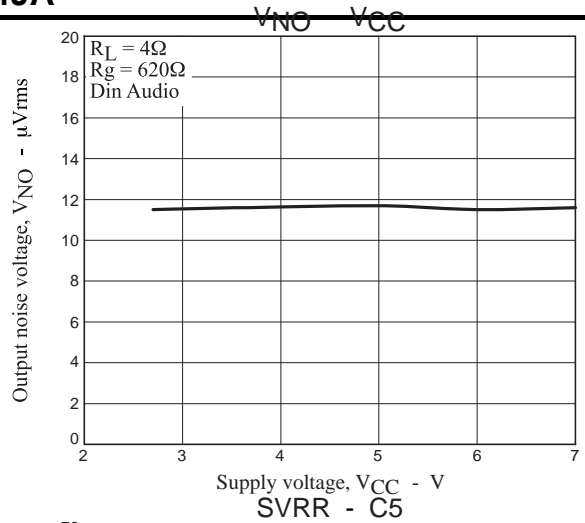
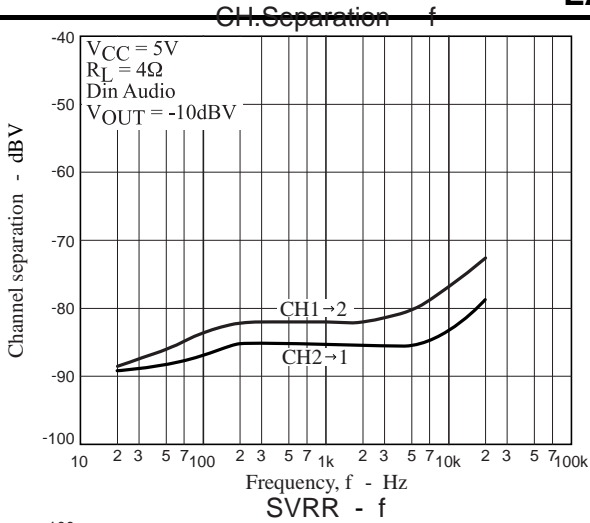

General characteristics BTL mode

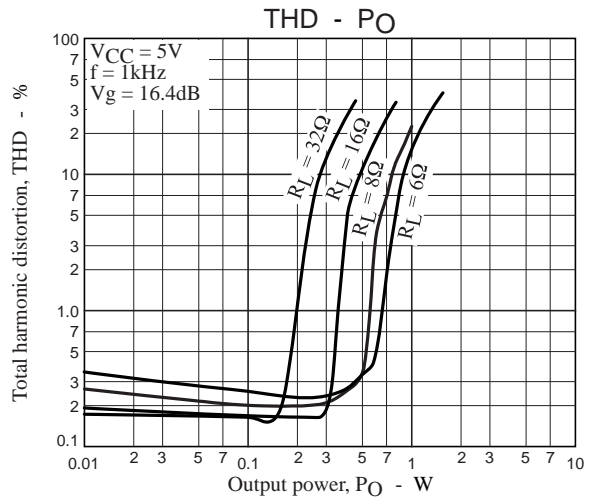
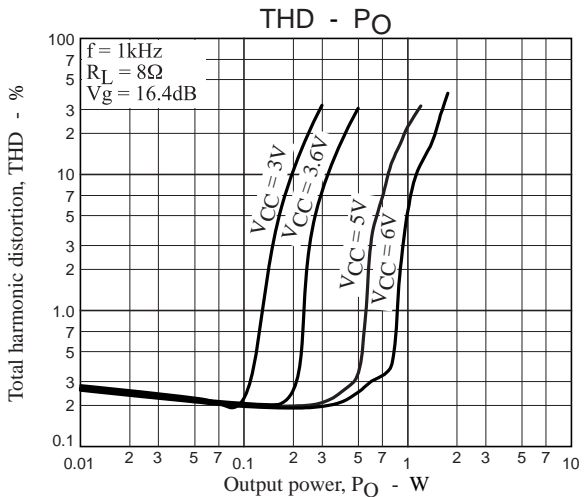

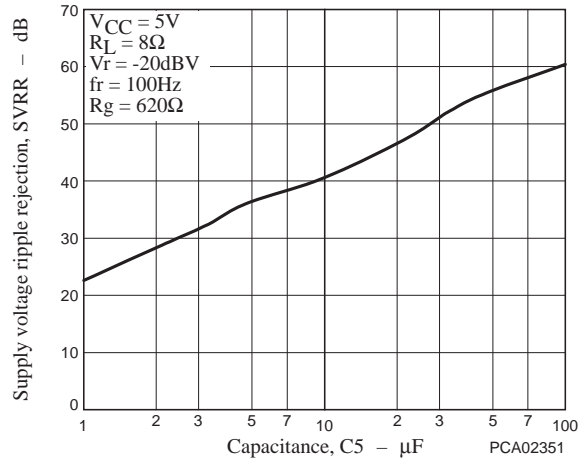
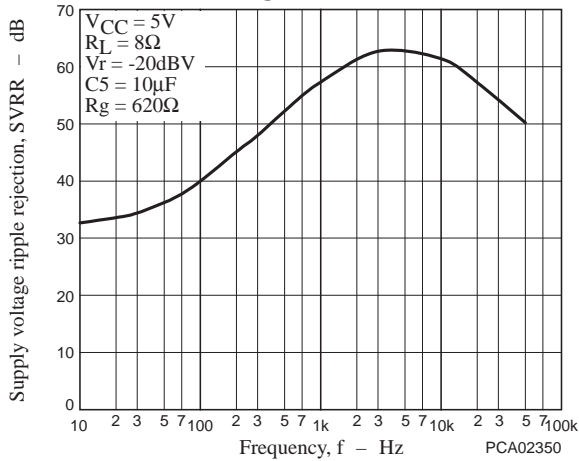
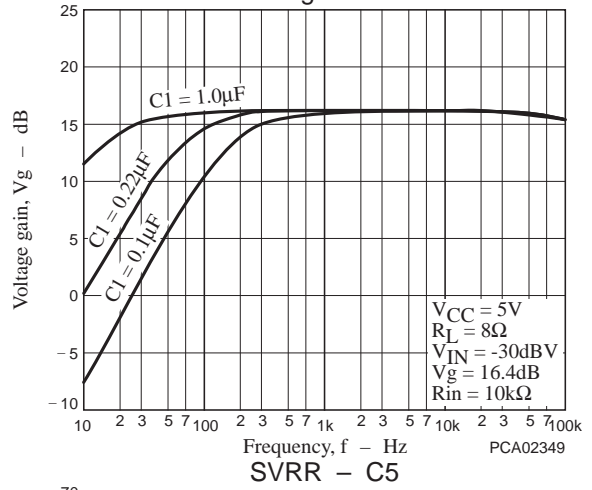
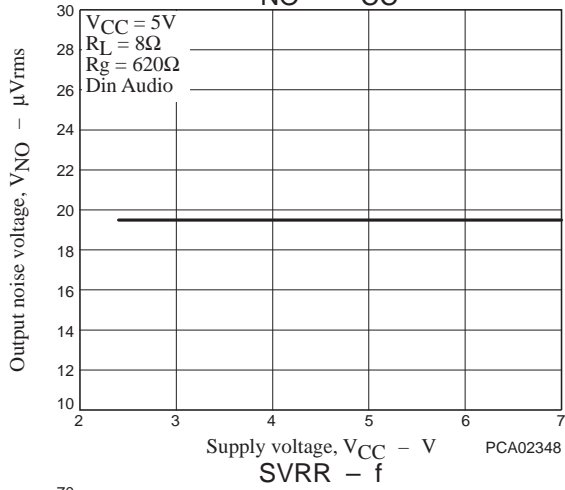
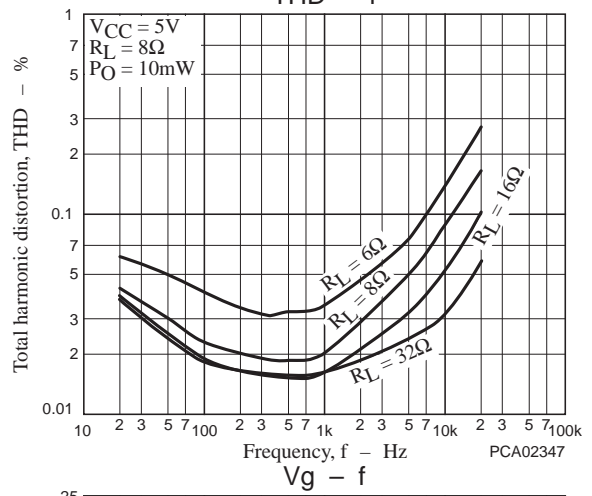
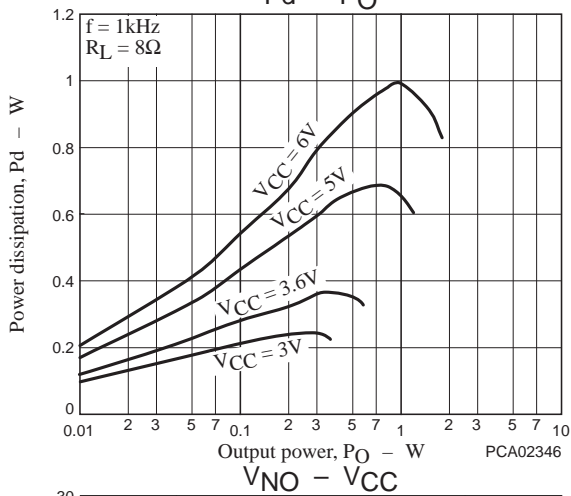
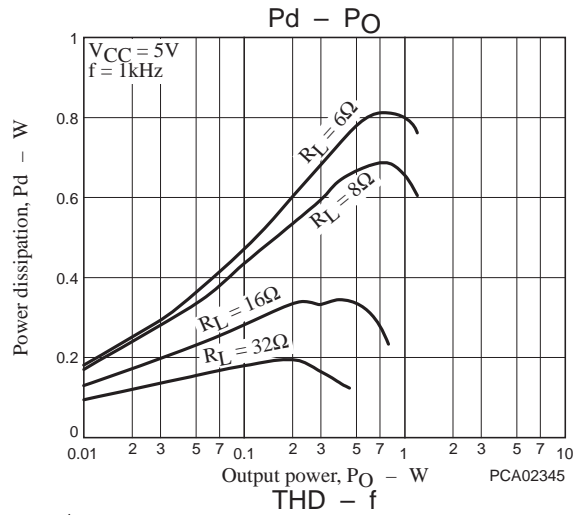
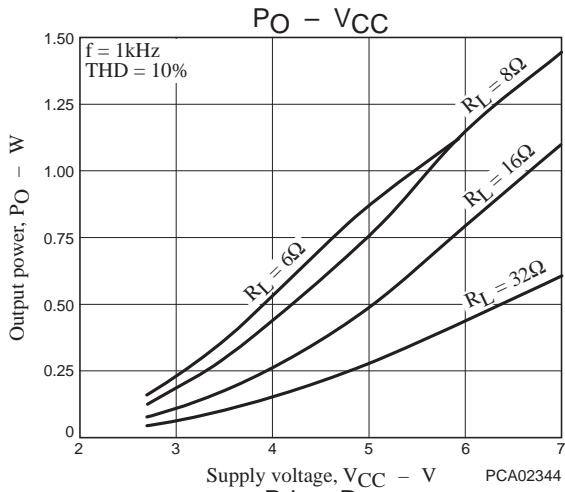

LA4814JA

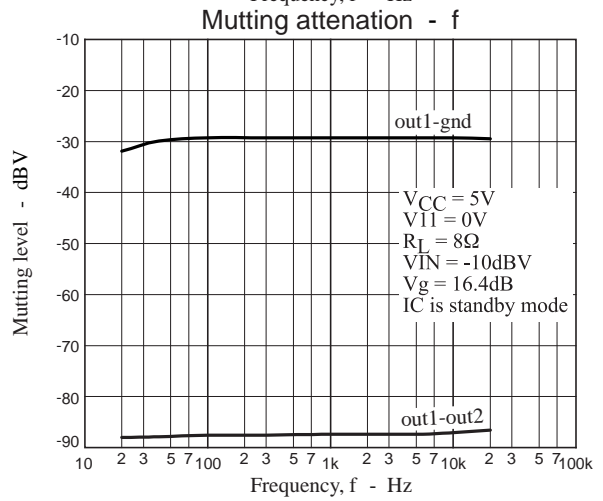
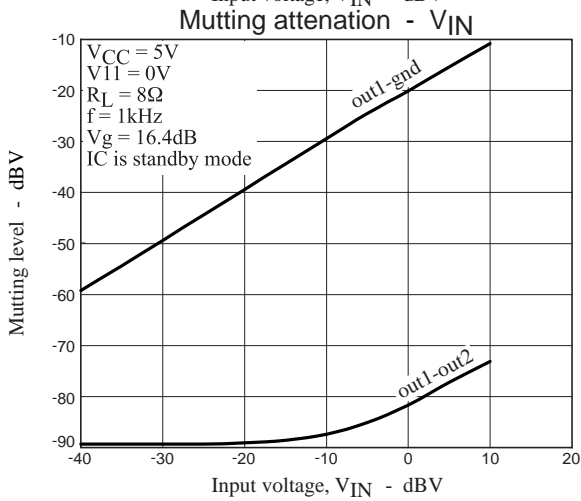
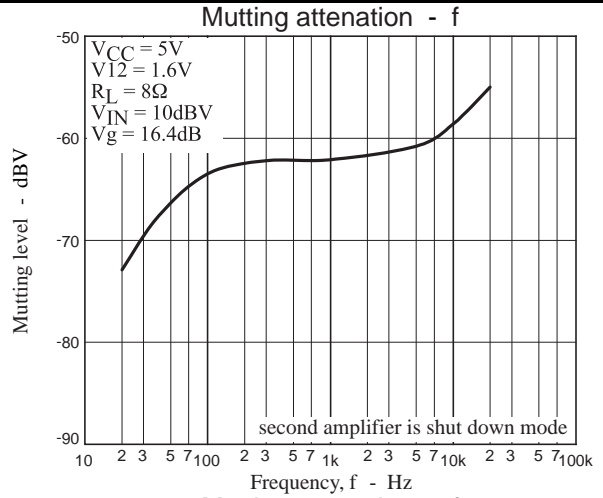
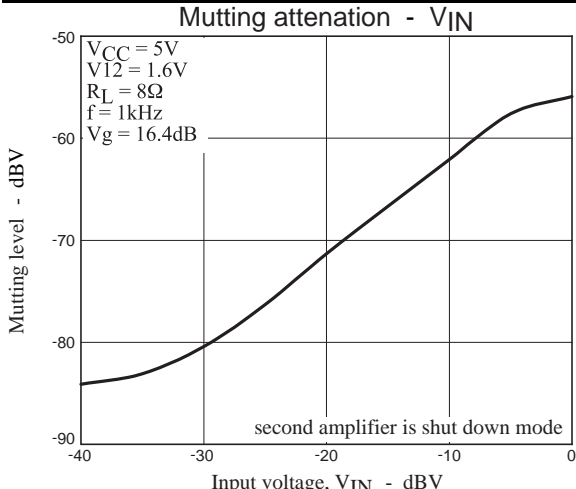

Temperature characteristics

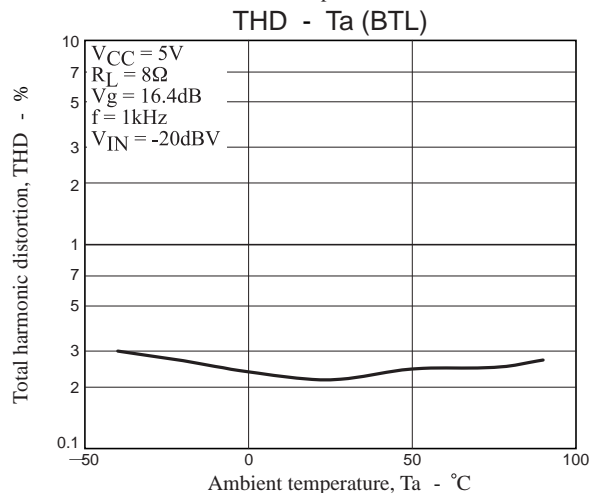
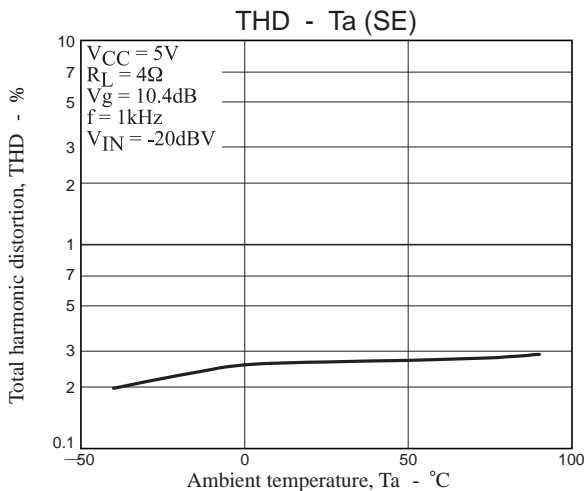
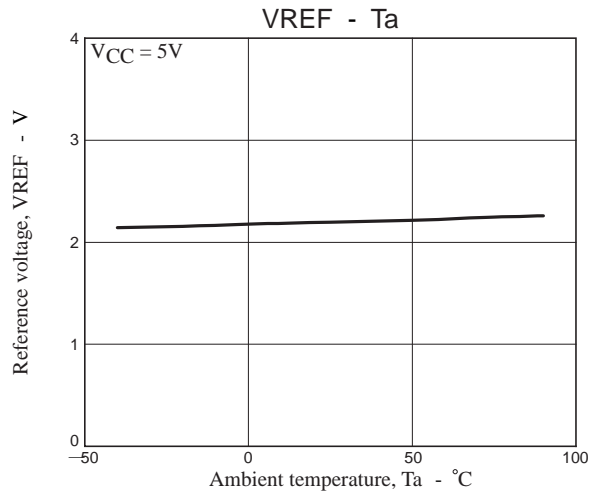
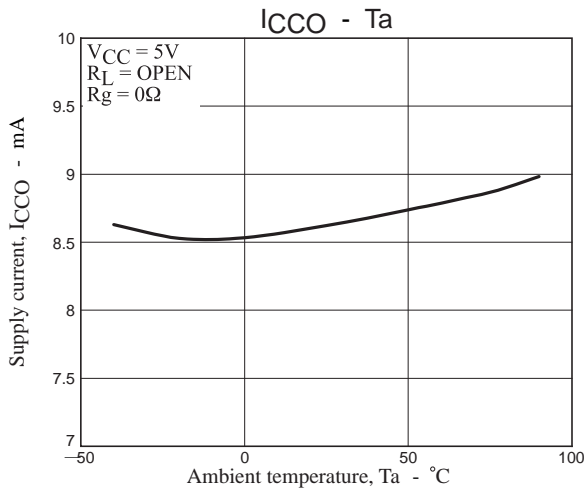

LA4814JA

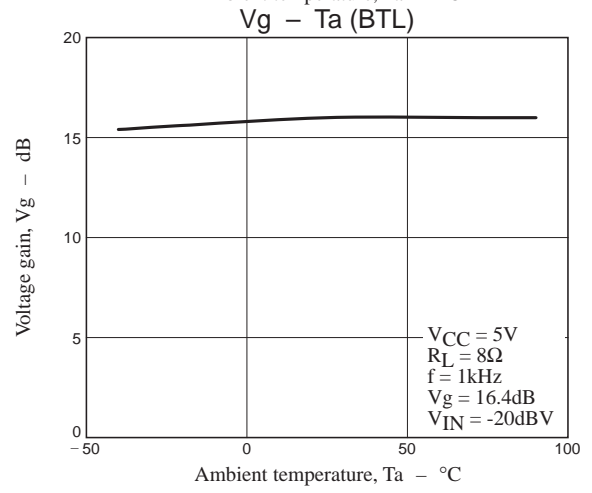
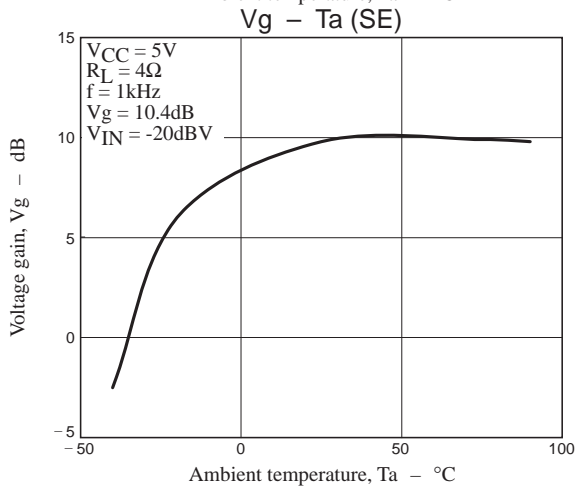
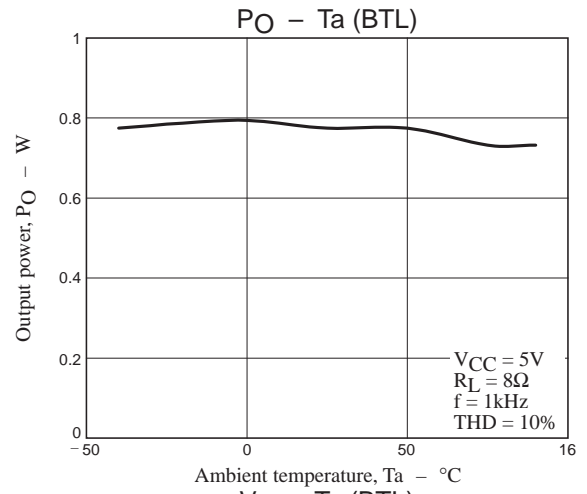
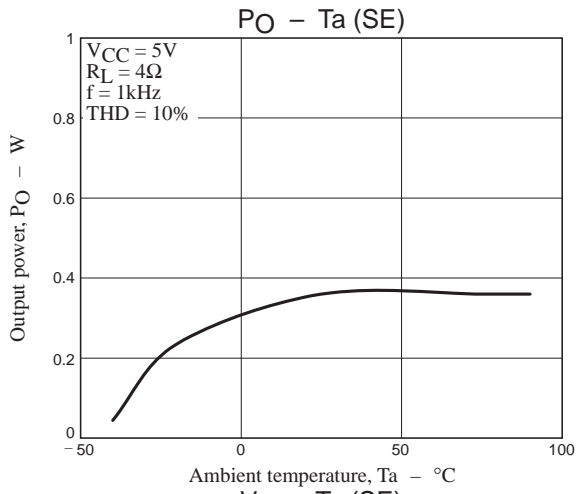

LA4814JA

Pop noise

Single ended mode : Turn-on transient response characteristic

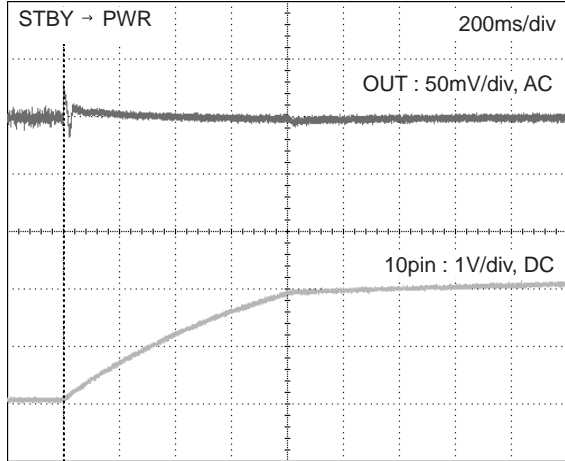

Single ended mode : Turn-off transient response characteristic

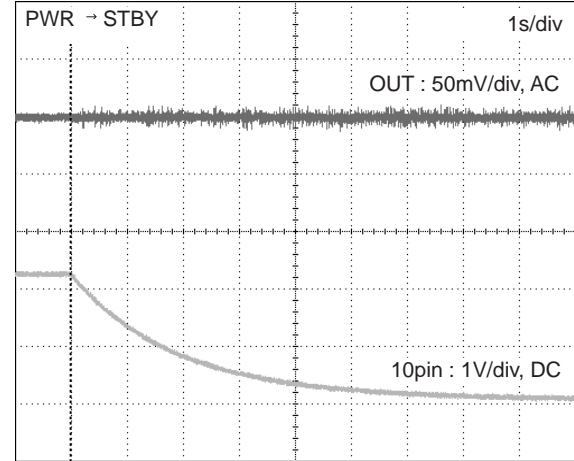

BTL mode: Turn-on transient response characteristic

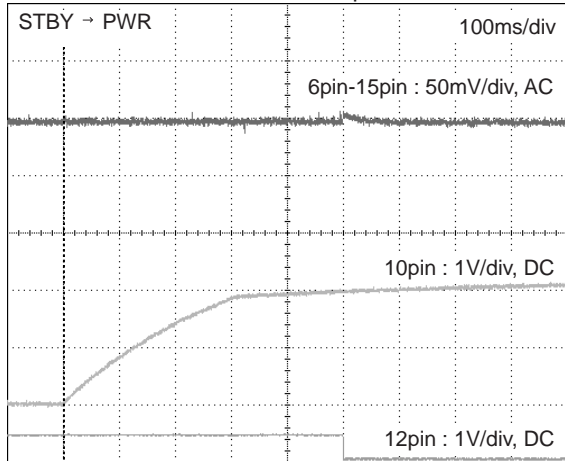

BTL mode: Turn-off transient response characteristic

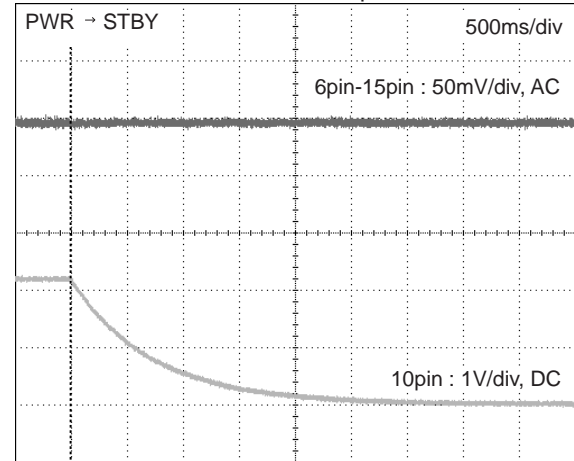

Evaluation board

1. Double-sided board

Size : 60mm×60mm×1.6mm

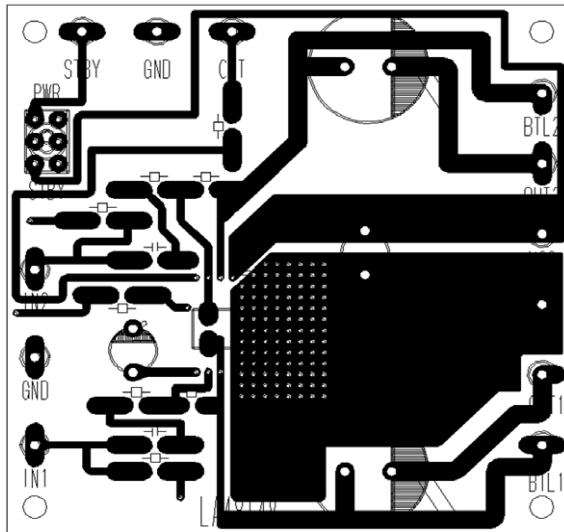

Top Layer

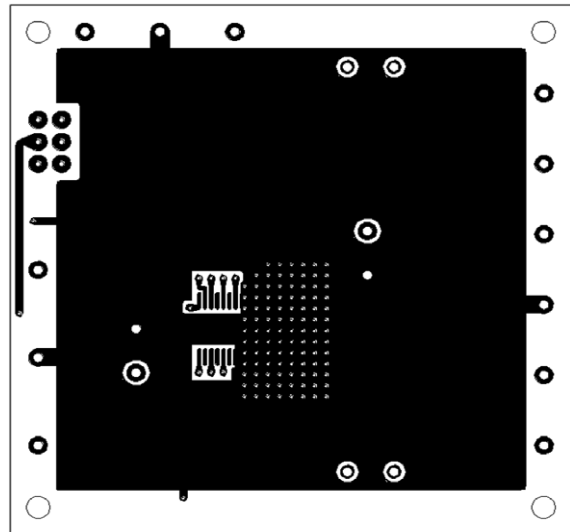

Bottom Layer

ON Semiconductor and the ON logo are registered trademarks of Semiconductor Components Industries, LLC (SCILLC). SCILLC owns the rights to a number of patents, trademarks, copyrights, trade secrets, and other intellectual property. A listing of SCILLC's product/patent coverage may be accessed at www.onsemi.com/site/pdf/Patent-Marking.pdf. SCILLC reserves the right to make changes without further notice to any products herein. SCILLC makes no warranty, representation or guarantee regarding the suitability of its products for any particular purpose, nor does SCILLC assume any liability arising out of the application or use of any product or circuit, and specifically disclaims any and all liability, including without limitation special, consequential or incidental damages. "Typical" parameters which may be provided in SCILLC data sheets and/or specifications can and do vary in different applications and actual performance may vary over time. All operating parameters, including "Typicals" must be validated for each customer application by customer's technical experts. SCILLC does not convey any license under its patent rights nor the rights of others. SCILLC products are not designed, intended, or authorized for use as components in systems intended for surgical implant into the body, or other applications intended to support or sustain life, or for any other application in which the failure of the SCILLC product could create a situation where personal injury or death may occur. Should Buyer purchase or use SCILLC products for any such unintended or unauthorized application, Buyer shall indemnify and hold SCILLC and its officers, employees, subsidiaries, affiliates, and distributors harmless against all claims, costs, damages, and expenses, and reasonable attorney fees arising out of, directly or indirectly, any claim of personal injury or death associated with such unintended or unauthorized use, even if such claim alleges that SCILLC was negligent regarding the design or manufacture of the part. SCILLC is an Equal Opportunity/Affirmative Action Employer. This literature is subject to all applicable copyright laws and is not for resale in any manner.



Компания «ЭлектроПласт» предлагает заключение долгосрочных отношений при поставках импортных электронных компонентов на взаимовыгодных условиях!

Наши преимущества:

- Оперативные поставки широкого спектра электронных компонентов отечественного и импортного производства напрямую от производителей и с крупнейших мировых складов;
- Поставка более 17-ти миллионов наименований электронных компонентов;
- Поставка сложных, дефицитных, либо снятых с производства позиций;
- Оперативные сроки поставки под заказ (от 5 рабочих дней);
- Экспресс доставка в любую точку России;
- Техническая поддержка проекта, помощь в подборе аналогов, поставка прототипов;
- Система менеджмента качества сертифицирована по Международному стандарту ISO 9001;
- Лицензия ФСБ на осуществление работ с использованием сведений, составляющих государственную тайну;
- Поставка специализированных компонентов (Xilinx, Altera, Analog Devices, Intersil, Interpoint, Microsemi, Aeroflex, Peregrine, Syfer, Eurofarad, Texas Instrument, Miteq, Cobham, E2V, MA-COM, Hittite, Mini-Circuits, General Dynamics и др.);

Помимо этого, одним из направлений компании «ЭлектроПласт» является направление «Источники питания». Мы предлагаем Вам помощь Конструкторского отдела:

- Подбор оптимального решения, техническое обоснование при выборе компонента;
- Подбор аналогов;
- Консультации по применению компонента;
- Поставка образцов и прототипов;
- Техническая поддержка проекта;
- Защита от снятия компонента с производства.



Как с нами связаться

Телефон: 8 (812) 309 58 32 (многоканальный)

Факс: 8 (812) 320-02-42

Электронная почта: org@eplast1.ru

Адрес: 198099, г. Санкт-Петербург, ул. Калинина, дом 2, корпус 4, литера А.