

3M™ Accessories

.100" x .100" Wiremount Socket



Contact Quantity	Dim B	Dim C
6	.48 [12.2]	n/a
8	.58 [14.7]	n/a
10	0.68 [17.3]	0.62 [15.7]
14	0.88 [22.4]	0.82 [20.8]
16	0.98 [24.9]	0.92 [23.4]
20	1.18 [30.0]	1.12 [28.4]
24	1.38 [35.1]	1.32 [33.5]
26	1.48 [37.6]	1.42 [36.1]
30	1.68 [42.7]	1.62 [41.1]
34	1.88 [47.8]	1.82 [46.2]
36	1.98 [50.3]	1.92 [48.8]
40	2.18 [55.4]	2.12 [53.8]
44	2.38 [60.5]	2.32 [58.9]
50	2.68 [68.1]	2.62 [66.5]
60	3.18 [80.8]	3.12 [79.2]



Strain Relief 3448-X0XX

Type:
2 = Metal
3 = Plastic

XX = "Contact Quantity" of Socket: (i.e. 50 for 50 Position Strain Relief)

Note:

- The notch is non-existent on 40 position and larger.
- RoHS* compliant

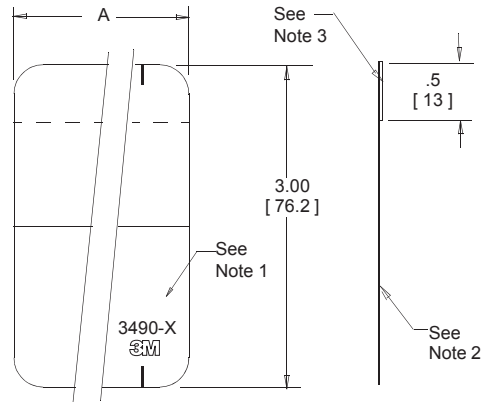

**"RoHS compliant" means that the product or part does not contain any of the following substances in excess of the following maximum concentration values in any homogeneous material, unless the substance is in an application that is exempt under RoHS: (a) 0.1% (by weight) for lead, mercury, hexavalent chromium, polybrominated biphenyls or polybrominated diphenyl ethers; or (b) 0.01% (by weight) for cadmium. Unless otherwise stated in writing by 3M, this information represents 3M's knowledge and belief based on information provided by third party suppliers to 3M.

3M Part Number	Dimension A ± .02
3490-1	0.50 [12.7]
3490-2	1.00 [25.4]
3490-3	1.50 [38.1]
3490-4	2.00 [50.8]
3490-5	2.50 [63.5]
3490-7	3.10 [78.7]
3490-6	3.25 [82.6]
3490-9 "No Product Labeling"	1.50 [38.1] width 2.00 [50.8] length
3490-10	0.26 [6.6]

Notes:

- Matte finish for ink labeling.
- Material: Polyester
Thickness: .005 ± .001
Flammability: Oxygen index minimum 28, ASTM D-2863.
- Material: Double sided adhesive tape with liner.
- RoHS compliant*.

Inch
[mm]

Tolerance Unless Noted			
	.0	.0.	.00.
Inch	±.1	±.01	±.005

[] Dimensions for Reference Only

Date Modified: May 22, 2012

TS-0720-D

Sheet 1 of 1

3M

Electronic Solutions Division
Interconnect Solutions
<http://www.3Mconnectors.com>

3M is a trademark of 3M Company.
For technical, sales or ordering information call
800-225-5373

3M is a trademark of 3M Company.

Important Notice

All statements, technical information, and recommendations related to 3M's products are based on information believed to be reliable, but the accuracy or completeness is not guaranteed. Before using this product, you must evaluate it and determine if it is suitable for your intended application. You assume all risks and liability associated with such use. Any statements related to the product which are not contained in 3M's current publications, or any contrary statements contained on your purchase order shall have no force or effect unless expressly agreed upon, in writing, by an authorized officer of 3M.

Warranty; Limited Remedy; Limited Liability.

This product will be free from defects in material and manufacture for a period of one (1) year from the time of purchase. **3M MAKES NO OTHER WARRANTIES INCLUDING, BUT NOT LIMITED TO, ANY IMPLIED WARRANTY OF MERCHANTABILITY OR FITNESS FOR A PARTICULAR PURPOSE.** If this product is defective within the warranty period stated above, your exclusive remedy shall be, at 3M's option, to replace or repair the 3M product or refund the purchase price of the 3M product. **Except where prohibited by law, 3M will not be liable for any indirect, special, incidental or consequential loss or damage arising from this 3M product, regardless of the legal theory asserted.**



3M Electronics Solutions Division

6801 River Place Blvd.
Austin, TX 78726-9000
U.S.A.
1-800-225-5373
www.3Mconnectors.com

Please recycle. Printed in USA.
© 3M 2012. All rights reserved.
RIA-2217B-E



Компания «ЭлектроПласт» предлагает заключение долгосрочных отношений при поставках импортных электронных компонентов на взаимовыгодных условиях!

Наши преимущества:

- Оперативные поставки широкого спектра электронных компонентов отечественного и импортного производства напрямую от производителей и с крупнейших мировых складов;
- Поставка более 17-ти миллионов наименований электронных компонентов;
- Поставка сложных, дефицитных, либо снятых с производства позиций;
- Оперативные сроки поставки под заказ (от 5 рабочих дней);
- Экспресс доставка в любую точку России;
- Техническая поддержка проекта, помощь в подборе аналогов, поставка прототипов;
- Система менеджмента качества сертифицирована по Международному стандарту ISO 9001;
- Лицензия ФСБ на осуществление работ с использованием сведений, составляющих государственную тайну;
- Поставка специализированных компонентов (Xilinx, Altera, Analog Devices, Intersil, Interpoint, Microsemi, Aeroflex, Peregrine, Syfer, Eurofarad, Texas Instrument, Miteq, Cobham, E2V, MA-COM, Hittite, Mini-Circuits, General Dynamics и др.);

Помимо этого, одним из направлений компании «ЭлектроПласт» является направление «Источники питания». Мы предлагаем Вам помощь Конструкторского отдела:

- Подбор оптимального решения, техническое обоснование при выборе компонента;
- Подбор аналогов;
- Консультации по применению компонента;
- Поставка образцов и прототипов;
- Техническая поддержка проекта;
- Защита от снятия компонента с производства.



Как с нами связаться

Телефон: 8 (812) 309 58 32 (многоканальный)

Факс: 8 (812) 320-02-42

Электронная почта: org@eplast1.ru

Адрес: 198099, г. Санкт-Петербург, ул. Калинина, дом 2, корпус 4, литера А.