

40V COMPLEMENTARY DUAL ENHANCEMENT MODE MOSFET

Product Summary

Device	V _{(BR)DSS}	R _{DS(on)} Max	I _D T _A = 25°C
Q1	40V	28mΩ @ V _{GS} = 10V	7.2A
		49mΩ @ V _{GS} = 4.5V	5.4A
Q2	-40V	50mΩ @ V _{GS} = -10V	-5.2A
		79mΩ @ V _{GS} = -4.5V	-4.7A

Features and Benefits

- Low on-resistance
- Fast switching speed
- "Lead Free", RoHS Compliant (Note 1)
- Halogen and Antimony Free "Green" Device (Note 2)
- Qualified to AEC-Q101 Standards for High Reliability

Description and Applications

This MOSFET has been designed to minimize the on-state resistance and yet maintain superior switching performance, making it ideal for high efficiency power management applications.

- Motor control
- Backlighting
- DC-DC Converters
- Power management functions

Mechanical Data

- Case: SO-8
- Case Material: Molded Plastic, "Green" Molding Compound. UL Flammability Classification Rating 94V-0 (Note 1)
- Moisture Sensitivity: Level 1 per J-STD-020
- Terminals Connections: See diagram below
- Terminals: Finish - Matte Tin annealed over Copper lead frame. Solderable per MIL-STD-202, Method 208
- Weight: 0.074 grams (approximate)

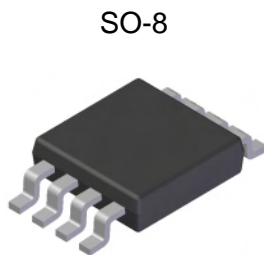

Top View

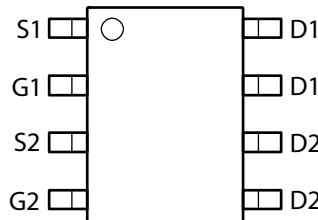

Top View

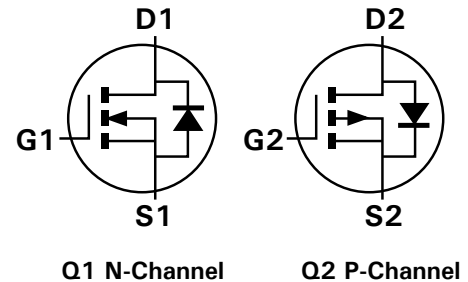

Equivalent Circuit

Ordering Information (Note 3)

Product	Marking	Reel size (inches)	Tape width (mm)	Quantity per reel
DMC4028SSD-13	C4028SD	13	12	2,500

- Notes:
1. No purposefully added lead.
 2. Diodes Inc.'s "Green" policy can be found on our website at <http://www.diodes.com>.
 3. For packaging details, go to our website at <http://www.diodes.com>.

Marking Information

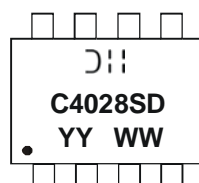

D = Manufacturer's Marking
 C4028SD = Product Type Marking Code
 YYWW = Date Code Marking
 YY = Year (ex: 09 = 2009)
 WW = Week (01 - 53)

Maximum Ratings @ $T_A = 25^\circ\text{C}$ unless otherwise specified

Characteristic			Symbol	N-Channel - Q1	P-Channel - Q2	Units
Drain-Source Voltage			V_{DSS}	40	-40	V
Gate-Source Voltage			V_{GSS}	± 20	± 20	V
Continuous Drain Current	$V_{GS} = 10\text{V}$	(Notes 6 & 8)	I_D	7.2	5.2	A
		$T_A = 70^\circ\text{C}$ (Notes 6 & 8)		5.5	4.2	
		(Notes 5 & 8)		5.4	4	
		(Notes 5 & 9)		6.5	4.8	
Pulsed Drain Current	$V_{GS} = 10\text{V}$	(Notes 7 & 8)	I_{DM}	27.3	20.4	A
Continuous Source Current (Body diode)			I_S	3.35	3.15	A
Pulsed Source Current (Body diode)			I_{SM}	27.3	20.4	A

Thermal Characteristics @ $T_A = 25^\circ\text{C}$ unless otherwise specified

Characteristic		Symbol	N-Channel - Q1	P-Channel - Q2	Unit
Power Dissipation Linear Derating Factor	(Notes 5 & 8)	P_D	1.25		W mW/ $^\circ\text{C}$
	(Notes 5 & 9)		10		
	(Notes 6 & 8)		1.8		
	(Notes 5 & 8)		14.3		
Thermal Resistance, Junction to Ambient	(Notes 5 & 8)	$R_{\theta JA}$	2.16		$^\circ\text{C/W}$
	(Notes 5 & 9)		17.2		
	(Notes 6 & 8)		100		
Thermal Resistance, Junction to Lead	(Notes 5 & 8)	$R_{\theta JL}$	70		$^\circ\text{C/W}$
	(Notes 6 & 8)		58		
Operating and Storage Temperature Range		T_J, T_{STG}	53	53	$^\circ\text{C}$
			-55 to +150		

- Notes:
- AEC-Q101 V_{GS} maximum is $\pm 16\text{V}$.
 - For a device surface mounted on 25mm x 25mm x 1.6mm FR4 PCB with high coverage of single sided 1oz copper, in still air conditions; the device is measured when operating in a steady-state condition.
 - Same as note (5), except the device is measured at $t \leq 10$ sec.
 - Same as note (5), except the device is pulsed with $D = 0.02$ and pulse width 300 μs . The pulse current is limited by the maximum junction temperature.
 - For a dual device with one active die.
 - For a device with two active die running at equal power.
 - Thermal resistance from junction to solder-point (at the end of the drain lead).

Thermal Characteristics

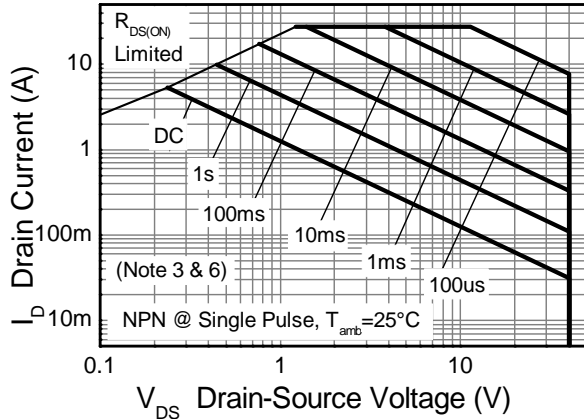

N-channel Safe Operating Area

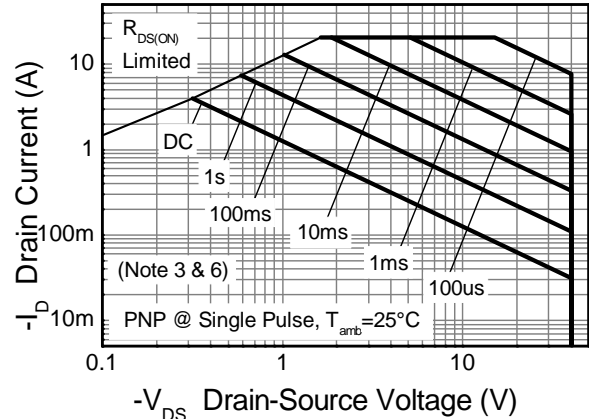

P-channel Safe Operating Area

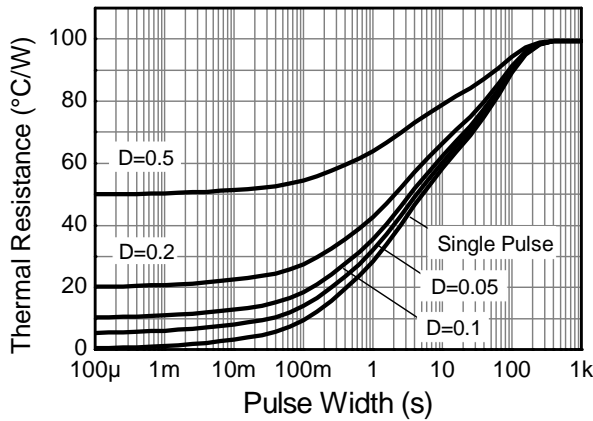

Transient Thermal Impedance

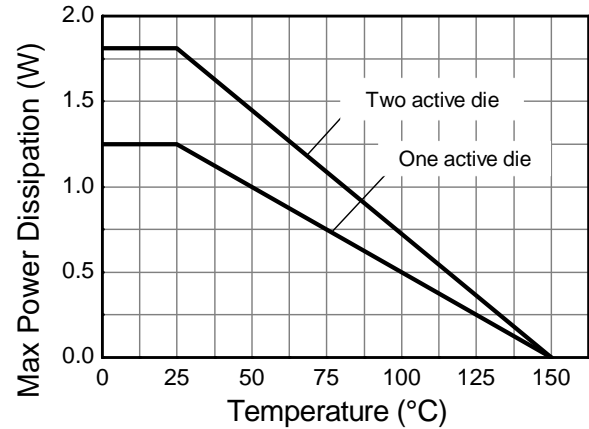

Derating Curve

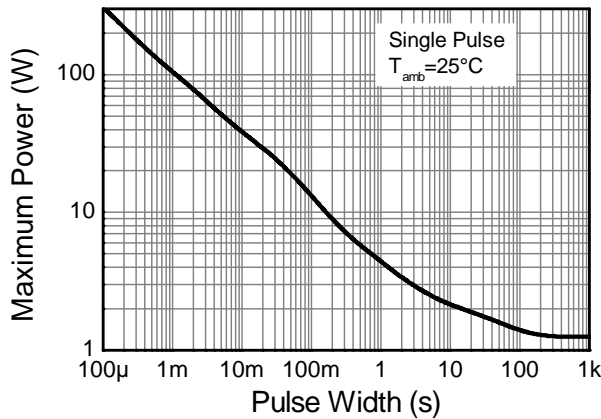

Pulse Power Dissipation

Electrical Characteristics – Q1 N-Channel $T_A = 25^\circ\text{C}$ unless otherwise specified

Characteristic	Symbol	Min	Typ	Max	Unit	Test Condition
OFF CHARACTERISTICS						
Drain-Source Breakdown Voltage	BV_{DSS}	40	—	—	V	$I_D = 250\mu\text{A}$, $V_{GS} = 0\text{V}$
Zero Gate Voltage Drain Current	I_{DSS}	—	—	0.5	μA	$V_{DS} = 40\text{V}$, $V_{GS} = 0\text{V}$
Gate-Source Leakage	I_{GSS}	—	—	± 100	nA	$V_{GS} = \pm 20\text{V}$, $V_{DS} = 0\text{V}$
ON CHARACTERISTICS						
Gate Threshold Voltage	$V_{GS(th)}$	1.0	—	3.0	V	$I_D = 250\mu\text{A}$, $V_{DS} = V_{GS}$
Static Drain-Source On-Resistance (Note 11)	$R_{DS(on)}$	—	0.018	0.028	Ω	$V_{GS} = 10\text{V}$, $I_D = 6\text{A}$
			0.033	0.049		$V_{GS} = 4.5\text{V}$, $I_D = 5\text{A}$
Forward Transconductance (Notes 11 & 12)	g_{fs}	—	22.8	—	S	$V_{DS} = 15\text{V}$, $I_D = 6\text{A}$
Diode Forward Voltage (Note 11)	V_{SD}	—	0.845	1.1	V	$I_S = 6\text{A}$, $V_{GS} = 0\text{V}$
Reverse recovery time (Note 12)	t_{rr}	—	135	—	ns	$I_S = 6\text{A}$, $di/dt = 100\text{A}/\mu\text{s}$
Reverse recovery charge (Note 12)	Q_{rr}	—	799	—	nC	
DYNAMIC CHARACTERISTICS (Note 12)						
Input Capacitance	C_{iss}	—	604	—	pF	$V_{DS} = 20\text{V}$, $V_{GS} = 0\text{V}$ $f = 1\text{MHz}$
Output Capacitance	C_{oss}	—	106	—	pF	
Reverse Transfer Capacitance	C_{rss}	—	59.6	—	pF	
Total Gate Charge (Note 13)	Q_g	—	6.5	—	nC	$V_{GS} = 4.5\text{V}$
Total Gate Charge (Note 13)	Q_g	—	12.9	—	nC	$V_{GS} = 10\text{V}$
Gate-Source Charge (Note 13)	Q_{gs}	—	2.3	—	nC	
Gate-Drain Charge (Note 13)	Q_{gd}	—	3.6	—	nC	$V_{DS} = 20\text{V}$ $I_D = 6\text{A}$
Turn-On Delay Time (Note 13)	$t_{D(on)}$	—	4.2	—	ns	
Turn-On Rise Time (Note 13)	t_r	—	12.4	—	ns	$V_{DD} = 20\text{V}$, $V_{GS} = 10\text{V}$ $I_D = 6\text{A}$, $R_G \equiv 6.0\Omega$
Turn-Off Delay Time (Note 13)	$t_{D(off)}$	—	13.8	—	ns	
Turn-Off Fall Time (Note 13)	t_f	—	10.7	—	ns	

- Notes:
11. Measured under pulsed conditions. Pulse width $\leq 300\mu\text{s}$; duty cycle $\leq 2\%$
 12. For design aid only, not subject to production testing.
 13. Switching characteristics are independent of operating junction temperatures.

Typical Characteristics – Q1 N-Channel

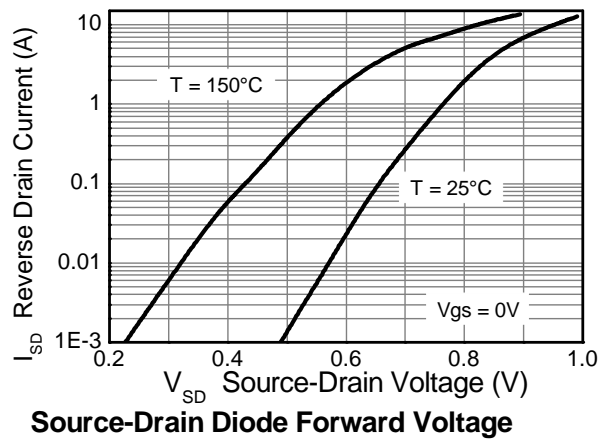
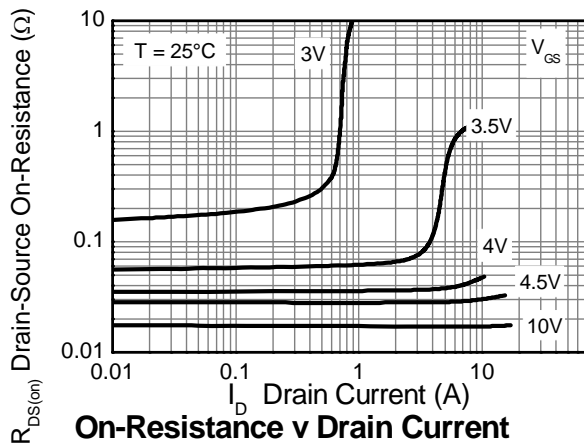
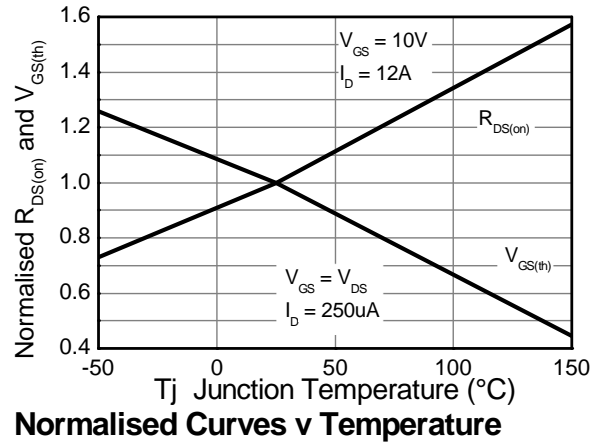
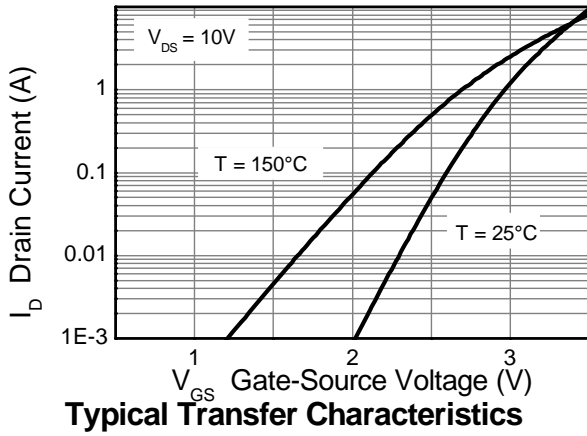
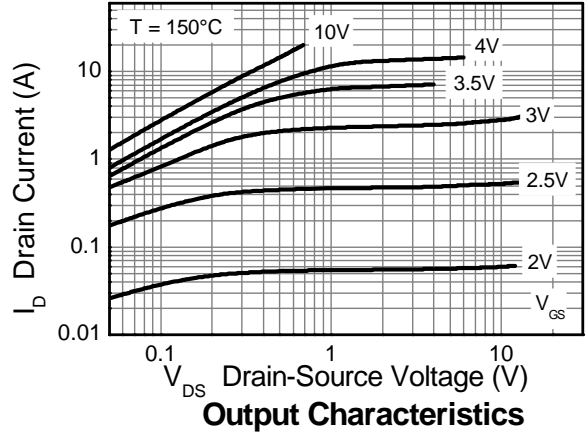
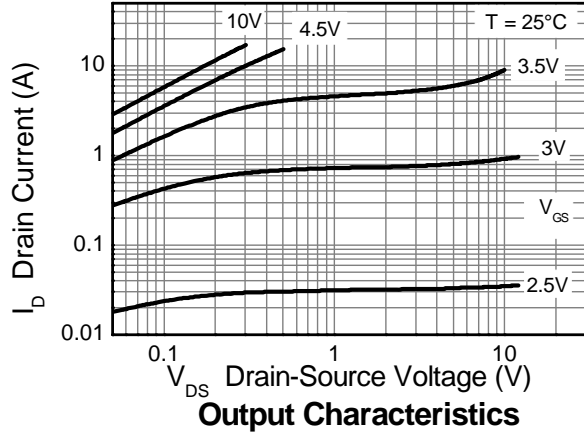

Typical Characteristics – Q1 N-Channel - continued

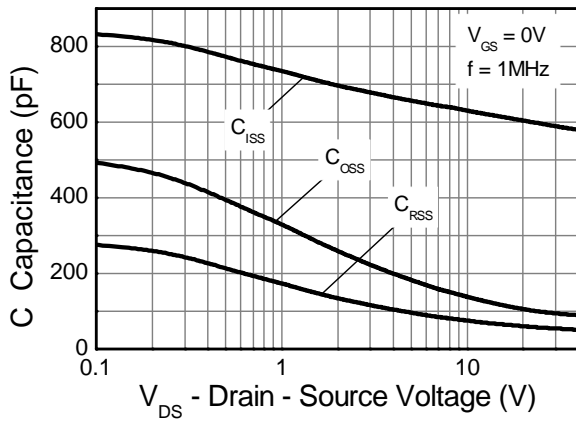

Capacitance v Drain-Source Voltage

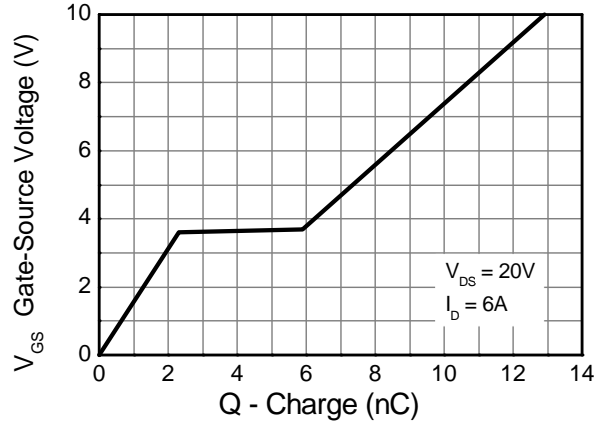

Gate-Source Voltage v Gate Charge

Test Circuits – Q1 N-Channel

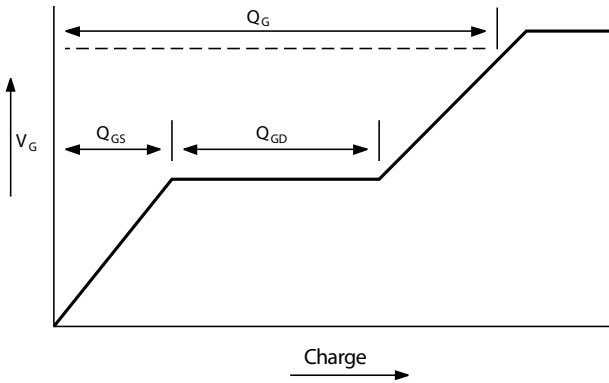

Basic gate charge waveform

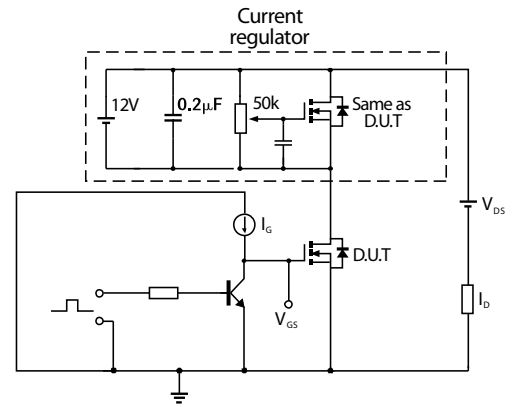

Gate charge test circuit

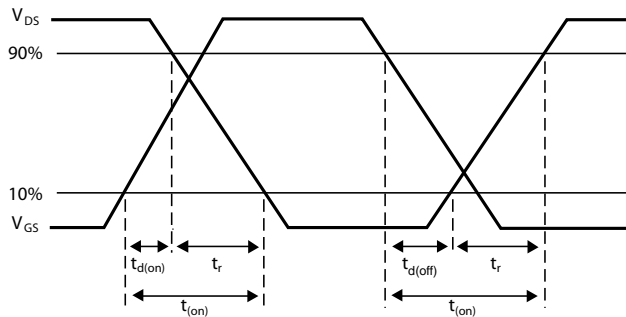

Switching time waveforms

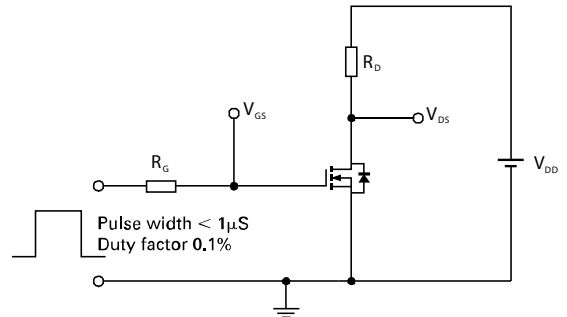

Switching time test circuit

Electrical Characteristics – Q2 P-Channel @ $T_A = 25^\circ\text{C}$ unless otherwise specified

Characteristic	Symbol	Min	Typ	Max	Unit	Test Condition
OFF CHARACTERISTICS						
Drain-Source Breakdown Voltage	BV_{DSS}	-40	–	–	V	$I_D = -250\mu\text{A}, V_{GS} = 0\text{V}$
Zero Gate Voltage Drain Current	I_{DSS}	–	–	-0.5	A	$V_{DS} = -40\text{V}, V_{GS} = 0\text{V}$
Gate-Source Leakage	I_{GSS}	–	–	± 100	nA	$V_{GS} = \pm 20\text{V}, V_{DS} = 0\text{V}$
ON CHARACTERISTICS						
Gate Threshold Voltage	$V_{GS(th)}$	-1.0	–	-3.0	V	$I_D = -250\mu\text{A}, V_{DS} = V_{GS}$
Static Drain-Source On-Resistance (Note 14)	$R_{DS(on)}$	–	0.039	0.050	Ω	$V_{GS} = -10\text{V}, I_D = -6\text{A}$
			0.060	0.079		$V_{GS} = -4.5\text{V}, I_D = -5\text{A}$
Forward Transconductance (Notes 14 & 15)	g_{fs}	–	16.6	–	S	$V_{DS} = -15\text{V}, I_D = -6\text{A}$
Diode Forward Voltage (Note 4)	V_{SD}	–	-0.865	-1.1	V	$I_S = -6\text{A}, V_{GS} = 0\text{V}$
Reverse recovery time (Note 15)	t_{rr}	–	138	–	ns	$I_S = -6\text{A}, di/dt = 100\text{A}/\mu\text{s}$
Reverse recovery charge (Note 15)	Q_{rr}	–	841	–	nC	
DYNAMIC CHARACTERISTICS (Note 15)						
Input Capacitance	C_{iss}	–	674	–	pF	$V_{DS} = -20\text{V}, V_{GS} = 0\text{V}$ $f = 1\text{MHz}$
Output Capacitance	C_{oss}	–	115	–	pF	
Reverse Transfer Capacitance	C_{rss}	–	67.7	–	pF	
Total Gate Charge (Note 16)	Q_g	–	7.0	–	nC	$V_{GS} = -4.5\text{V}$
Total Gate Charge (Note 16)	Q_g	–	14	–	nC	$V_{GS} = -10\text{V}$ $V_{DS} = -20\text{V}$ $I_D = -6\text{A}$
Gate-Source Charge (Note 16)	Q_{gs}	–	2.2	–	nC	
Gate-Drain Charge (Note 16)	Q_{gd}	–	3.7	–	nC	
Turn-On Delay Time (Note 16)	$t_{D(on)}$	–	2.3	–	ns	$V_{DD} = -20\text{V}, V_{GS} = -10\text{V}$ $I_D = -6\text{A}, R_G \cong 6.0\Omega$
Turn-On Rise Time (Note 16)	t_r	–	14.1	–	ns	
Turn-Off Delay Time (Note 16)	$t_{D(off)}$	–	25.1	–	ns	
Turn-Off Fall Time (Note 16)	t_f	–	14.3	–	ns	

Notes: 14. Measured under pulsed conditions. Pulse width $\leq 300\mu\text{s}$; duty cycle $\leq 2\%$
15. For design aid only, not subject to production testing.
16. Switching characteristics are independent of operating junction temperatures.

Typical Characteristics – Q2 P-Channel

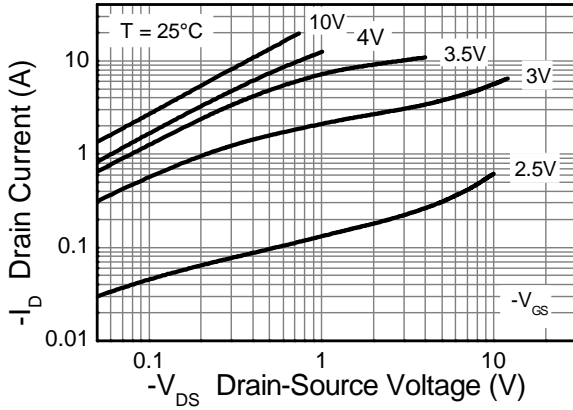

Output Characteristics

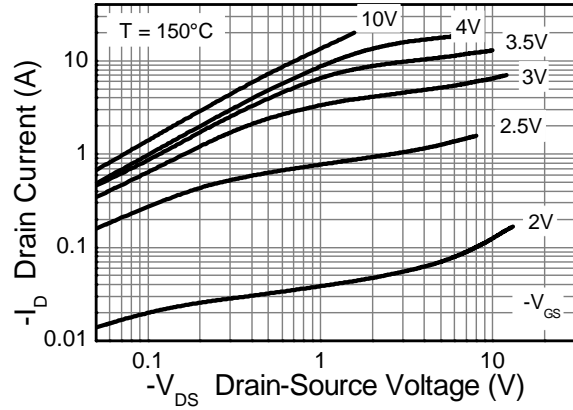

Output Characteristics

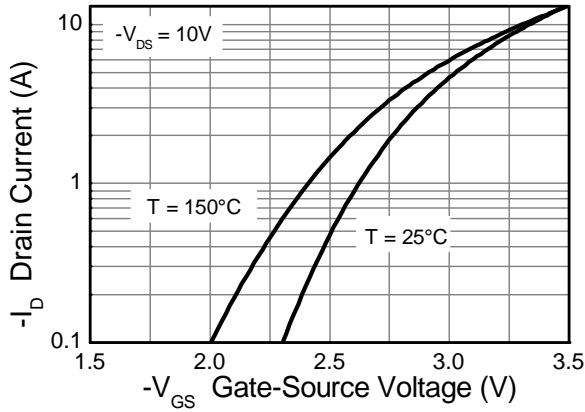

Typical Transfer Characteristics

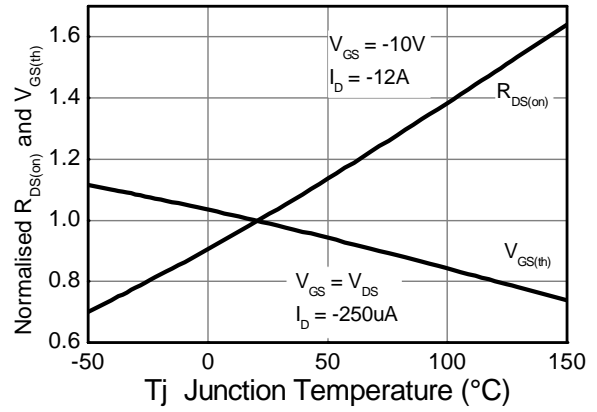

Normalised Curves v Temperature

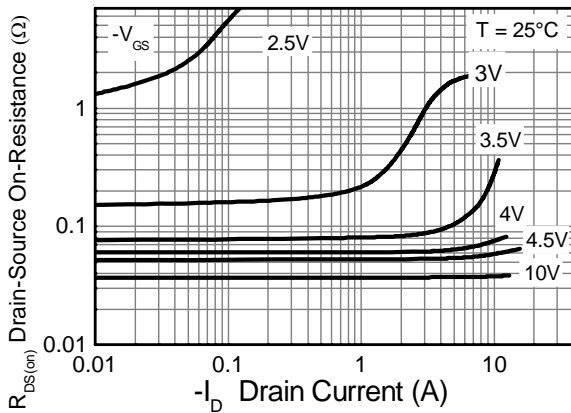

On-Resistance v Drain Current

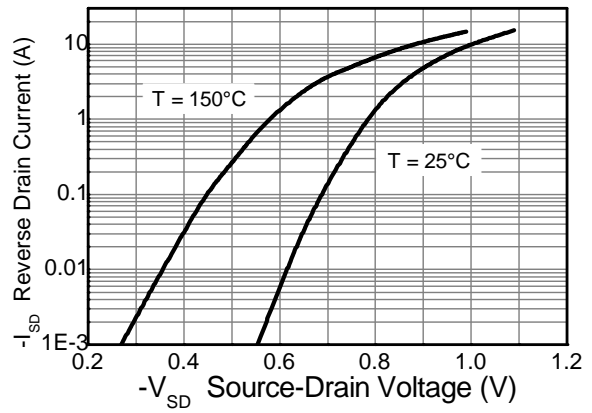

Source-Drain Diode Forward Voltage

Typical Characteristics – Q2 P-Channel - continued

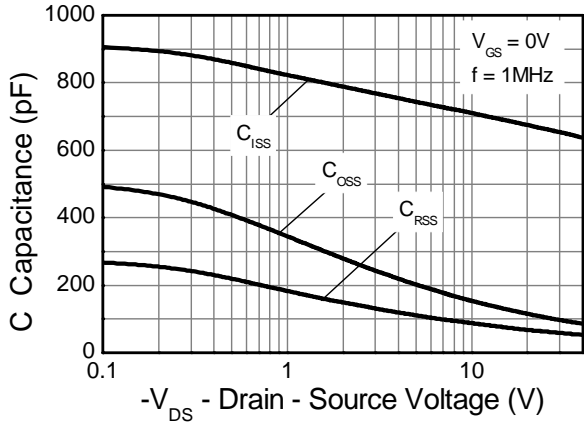

Capacitance v Drain-Source Voltage

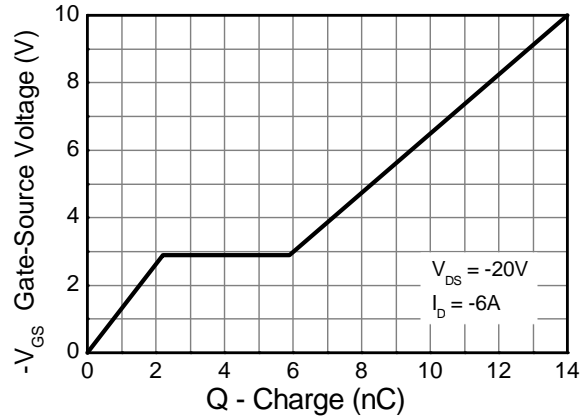

Gate-Source Voltage v Gate Charge

Test Circuits – Q2 P-Channel

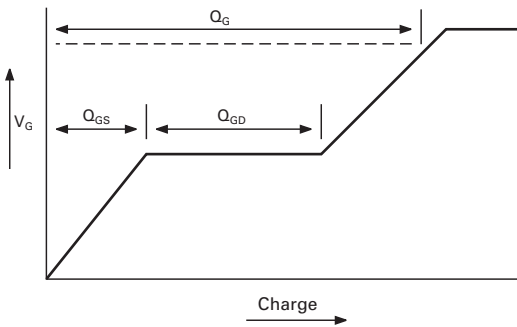

Basic gate charge waveform

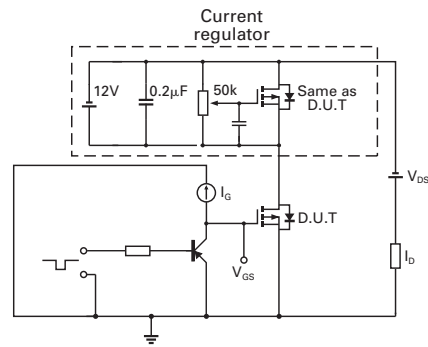

Gate charge test circuit

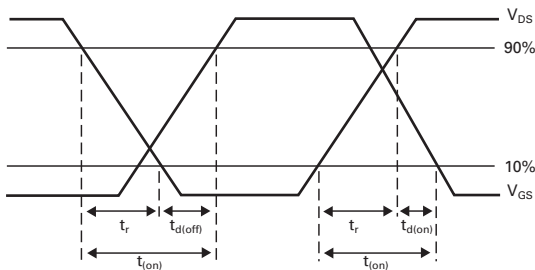

Switching time waveforms

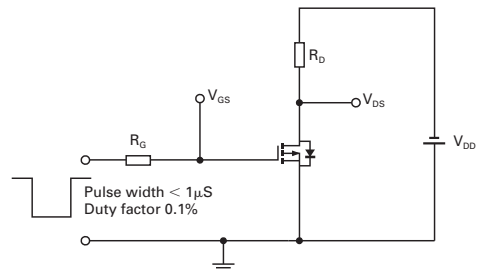

Switching time test circuit

Package Outline Dimensions

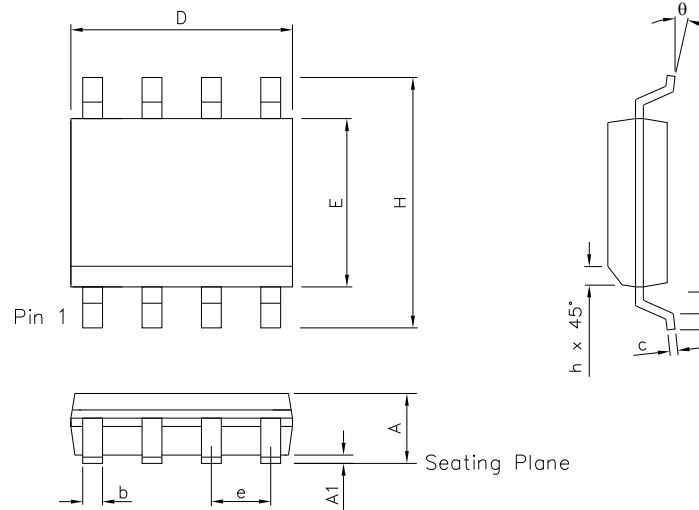

DIM	Inches		Millimeters		DIM	Inches		Millimeters	
	Min.	Max.	Min.	Max.		Min.	Max.	Min.	Max.
A	0.053	0.069	1.35	1.75	e	0.050 BSC		1.27 BSC	
A1	0.004	0.010	0.10	0.25	b	0.013	0.020	0.33	0.51
D	0.189	0.197	4.80	5.00	c	0.008	0.010	0.19	0.25
H	0.228	0.244	5.80	6.20	theta	0°	8°	0°	8°
E	0.150	0.157	3.80	4.00	h	0.010	0.020	0.25	0.50
L	0.016	0.050	0.40	1.27	-	-	-	-	-

Suggested Pad Layout

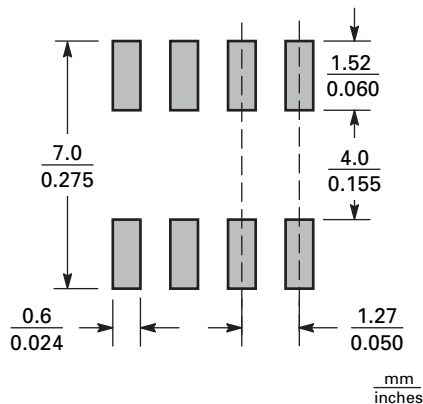

IMPORTANT NOTICE

DIODES INCORPORATED MAKES NO WARRANTY OF ANY KIND, EXPRESS OR IMPLIED, WITH REGARDS TO THIS DOCUMENT, INCLUDING, BUT NOT LIMITED TO, THE IMPLIED WARRANTIES OF MERCHANTABILITY AND FITNESS FOR A PARTICULAR PURPOSE (AND THEIR EQUIVALENTS UNDER THE LAWS OF ANY JURISDICTION).

Diodes Incorporated and its subsidiaries reserve the right to make modifications, enhancements, improvements, corrections or other changes without further notice to this document and any product described herein. Diodes Incorporated does not assume any liability arising out of the application or use of this document or any product described herein; neither does Diodes Incorporated convey any license under its patent or trademark rights, nor the rights of others. Any Customer or user of this document or products described herein in such applications shall assume all risks of such use and will agree to hold Diodes Incorporated and all the companies whose products are represented on Diodes Incorporated website, harmless against all damages.

Diodes Incorporated does not warrant or accept any liability whatsoever in respect of any products purchased through unauthorized sales channel. Should Customers purchase or use Diodes Incorporated products for any unintended or unauthorized application, Customers shall indemnify and hold Diodes Incorporated and its representatives harmless against all claims, damages, expenses, and attorney fees arising out of, directly or indirectly, any claim of personal injury or death associated with such unintended or unauthorized application.

Products described herein may be covered by one or more United States, international or foreign patents pending. Product names and markings noted herein may also be covered by one or more United States, international or foreign trademarks.

LIFE SUPPORT

Diodes Incorporated products are specifically not authorized for use as critical components in life support devices or systems without the express written approval of the Chief Executive Officer of Diodes Incorporated. As used herein:

A. Life support devices or systems are devices or systems which:

1. are intended to implant into the body, or
2. support or sustain life and whose failure to perform when properly used in accordance with instructions for use provided in the labeling can be reasonably expected to result in significant injury to the user.

B. A critical component is any component in a life support device or system whose failure to perform can be reasonably expected to cause the failure of the life support device or to affect its safety or effectiveness.

Customers represent that they have all necessary expertise in the safety and regulatory ramifications of their life support devices or systems, and acknowledge and agree that they are solely responsible for all legal, regulatory and safety-related requirements concerning their products and any use of Diodes Incorporated products in such safety-critical, life support devices or systems, notwithstanding any devices- or systems-related information or support that may be provided by Diodes Incorporated. Further, Customers must fully indemnify Diodes Incorporated and its representatives against any damages arising out of the use of Diodes Incorporated products in such safety-critical, life support devices or systems.

Copyright © 2010, Diodes Incorporated

www.diodes.com



Компания «ЭлектроПласт» предлагает заключение долгосрочных отношений при поставках импортных электронных компонентов на взаимовыгодных условиях!

Наши преимущества:

- Оперативные поставки широкого спектра электронных компонентов отечественного и импортного производства напрямую от производителей и с крупнейших мировых складов;
- Поставка более 17-ти миллионов наименований электронных компонентов;
- Поставка сложных, дефицитных, либо снятых с производства позиций;
- Оперативные сроки поставки под заказ (от 5 рабочих дней);
- Экспресс доставка в любую точку России;
- Техническая поддержка проекта, помощь в подборе аналогов, поставка прототипов;
- Система менеджмента качества сертифицирована по Международному стандарту ISO 9001;
- Лицензия ФСБ на осуществление работ с использованием сведений, составляющих государственную тайну;
- Поставка специализированных компонентов (Xilinx, Altera, Analog Devices, Intersil, Interpoint, Microsemi, Aeroflex, Peregrine, Syfer, Eurofarad, Texas Instrument, Miteq, Cobham, E2V, MA-COM, Hittite, Mini-Circuits, General Dynamics и др.);

Помимо этого, одним из направлений компании «ЭлектроПласт» является направление «Источники питания». Мы предлагаем Вам помощь Конструкторского отдела:

- Подбор оптимального решения, техническое обоснование при выборе компонента;
- Подбор аналогов;
- Консультации по применению компонента;
- Поставка образцов и прототипов;
- Техническая поддержка проекта;
- Защита от снятия компонента с производства.



Как с нами связаться

Телефон: 8 (812) 309 58 32 (многоканальный)

Факс: 8 (812) 320-02-42

Электронная почта: org@eplast1.ru

Адрес: 198099, г. Санкт-Петербург, ул. Калинина, дом 2, корпус 4, литера А.