

LQA30T200C, LQA30B200C

Qspeed™ Family



200 V, 30 A Common-Cathode Diode

Product Summary

| | | |
|------------------------------------|------|----|
| $I_{F(AVG)}$ per diode | 15 | A |
| V_{RRM} | 200 | V |
| Q_{RR} (Typ at 125 °C) | 55.4 | nC |
| I_{RRM} (Typ at 125 °C) | 3.5 | A |
| Softness t_b/t_a (Typ at 125 °C) | 0.31 | |

Pin Assignment

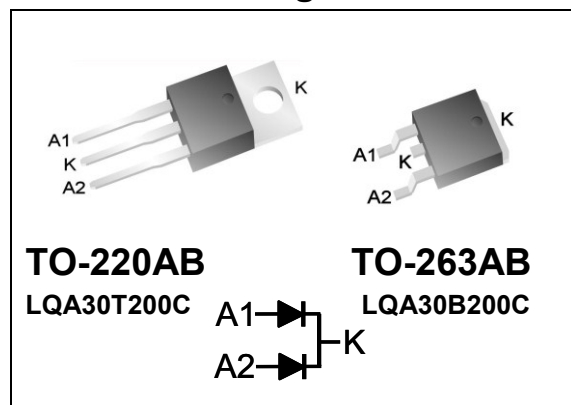

RoHS Compliant

Package uses Lead-free plating and "Green" mold compound Halogen free per IEC 61249-2-21.

Absolute Maximum Ratings

Absolute maximum ratings are the values beyond which the device may be damaged or have its useful life impaired. Functional operation under these conditions is not implied.

| Symbol | Parameter | Conditions | Rating | Units |
|--------------|--------------------------------------|---|------------|-------|
| V_{RRM} | Peak repetitive reverse voltage | $T_J = 25\text{ °C}$ | 200 | V |
| $I_{F(AVG)}$ | Average forward current | Per Diode, $T_J = 150\text{ °C}$, $T_C = 120\text{ °C}$ | 15 | A |
| | | Per Device, $T_J = 150\text{ °C}$, $T_C = 120\text{ °C}$ | 30 | A |
| I_{FSM} | Non-repetitive peak surge current | Per Diode, 60 Hz, 1/2 cycle | 130 | A |
| I_{FSM} | Non-repetitive peak surge current | Per Diode, 1/2 cycle of $t = 28\text{ }\mu\text{s}$ Sinusoid, $T_C = 25\text{ °C}$ | 350 | A |
| T_J | Operating junction temperature range | | -55 to 150 | °C |
| T_{STG} | Storage temperature | | -55 to 150 | °C |
| | Lead soldering temperature | Leads at 1.6 mm from case, 10 sec | 300 | °C |
| P_D | Power dissipation | $T_C = 25\text{ °C}$ | 56.8 | W |

Thermal Resistance

| Symbol | Resistance from: | Conditions | Rating | Units |
|-----------------|---------------------|-----------------|--------|-------|
| $R_{\theta JA}$ | Junction to ambient | TO-220AB (only) | 62 | °C/W |
| $R_{\theta JC}$ | Junction to case | Per Diode | 2.2 | °C/W |
| | | Per Device | 1.1 | °C/W |

General Description

This device has the lowest Q_{RR} of any 200 V Silicon diode. Its recovery characteristics increase efficiency, reduce EMI and eliminate snubbers.

Applications

- AC/DC and DC/DC output rectification
 - Output and freewheeling diodes
- Motor drive circuits
- DC-AC inverters

Features

- Low Q_{RR} , Low I_{RRM} , Low t_{RR}
- High dI_F/dt capable (1000A/ μs)
- Soft recovery

Benefits

- Increases efficiency
 - Eliminates need for snubber circuits
 - Reduces EMI filter component size and count
- Enables extremely fast switching

Electrical Specifications at $T_J = 25\text{ }^\circ\text{C}$ (unless otherwise specified)

| Symbol | Parameter | Conditions | Min | Typ | Max | Units | |
|--|---|--|-----------------------------------|------|------|---------------|----|
| DC Characteristics per diode | | | | | | | |
| I_R | Reverse current per diode | $V_R = 200\text{ V}, T_J = 25\text{ }^\circ\text{C}$ | - | - | 500 | μA | |
| | | $V_R = 200\text{ V}, T_J = 125\text{ }^\circ\text{C}$ | - | 0.6 | - | mA | |
| V_F | Forward voltage per diode | $I_F = 15\text{ A}, T_J = 25\text{ }^\circ\text{C}$ | - | 0.98 | 1.2 | V | |
| | | $I_F = 15\text{ A}, T_J = 150\text{ }^\circ\text{C}$ | - | 0.86 | - | V | |
| C_J | Junction capacitance per diode | $V_R = 10\text{ V}, 1\text{ MHz}$ | - | 54 | - | pF | |
| Dynamic Characteristics per diode | | | | | | | |
| t_{RR} | Reverse recovery time, per diode | $di_F/dt = 200\text{ A}/\mu\text{s}$ $V_R = 130\text{ V},$ $I_F = 15\text{ A}$ | $T_J = 25\text{ }^\circ\text{C}$ | - | 16.5 | - | ns |
| | | | $T_J = 125\text{ }^\circ\text{C}$ | - | 25.4 | - | ns |
| Q_{RR} | Reverse recovery charge, per diode | $di_F/dt = 200\text{ A}/\mu\text{s}$ $V_R = 130\text{ V},$ $I_F = 15\text{ A}$ | $T_J = 25\text{ }^\circ\text{C}$ | - | 21.5 | 33 | nC |
| | | | $T_J = 125\text{ }^\circ\text{C}$ | - | 55.4 | - | nC |
| I_{RRM} | Maximum reverse recovery current, per diode | $di_F/dt = 200\text{ A}/\mu\text{s}$ $V_R = 130\text{ V},$ $I_F = 15\text{ A}$ | $T_J = 25\text{ }^\circ\text{C}$ | - | 2.1 | 3.1 | A |
| | | | $T_J = 125\text{ }^\circ\text{C}$ | - | 3.5 | - | A |
| S | Softness per diode = $\frac{t_b}{t_a}$ | $di_F/dt = 200\text{ A}/\mu\text{s}$ $V_R = 130\text{ V},$ $I_F = 15\text{ A}$ | $T_J = 25\text{ }^\circ\text{C}$ | - | 0.44 | - | |
| | | | $T_J = 125\text{ }^\circ\text{C}$ | - | 0.31 | - | |

Note to component engineers: Q-Series diodes employ Schottky technologies in their design and construction. Therefore, component engineers should plan their test setups to be similar to traditional Schottky test setups. (For further details, see application note AN-300.)

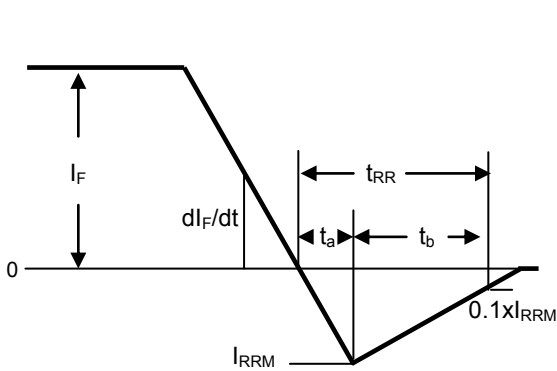

Figure 1. Reverse Recovery Definitions

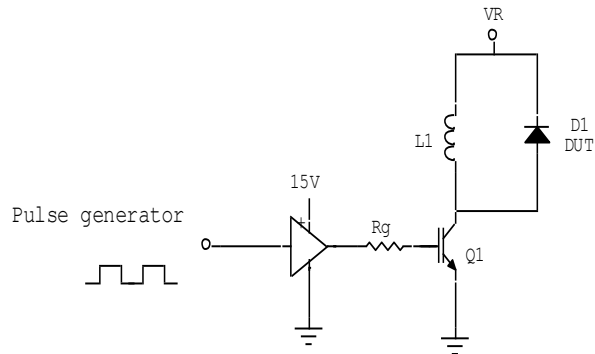

Figure 2. Reverse Recovery Test Circuit

Electrical Specifications at $T_J = 25\text{ }^\circ\text{C}$ (unless otherwise specified)

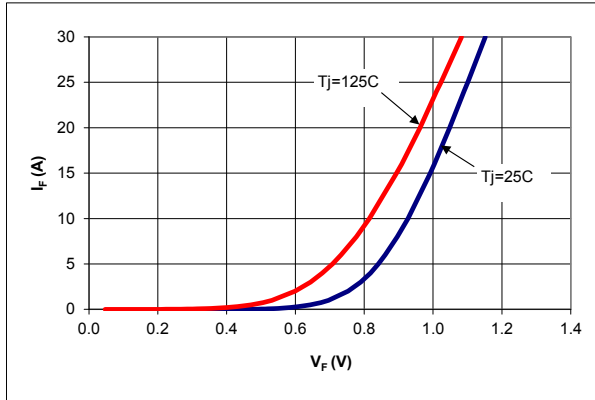

Figure 3. Typical I_F vs V_F

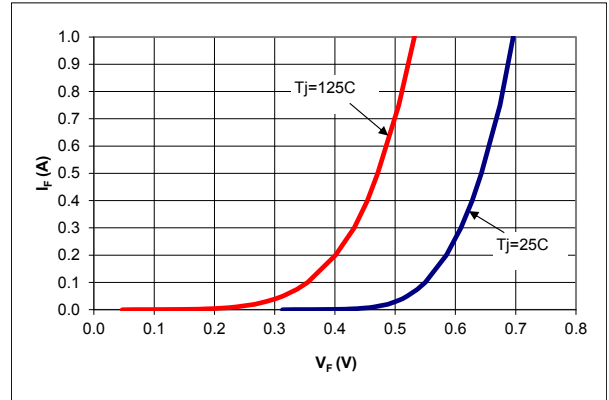

Figure 4. Typical I_F vs V_F

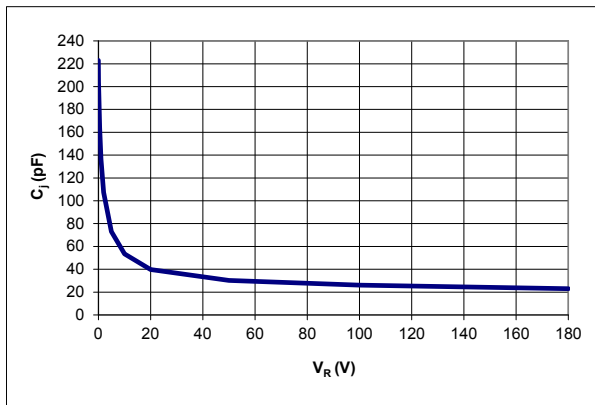

Figure 5. Typical C_i vs V_R

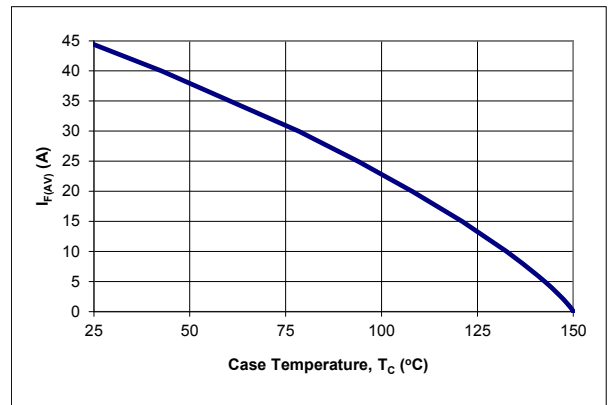

Figure 6. DC Current Derating Curve

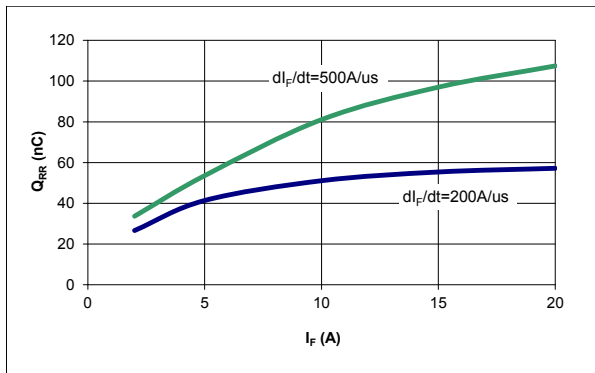

Figure 7. Typical Q_{RR} vs I_F at $T_J = 125\text{ }^\circ\text{C}$

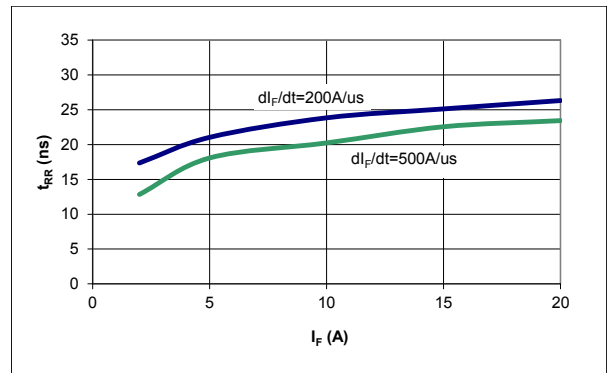

Figure 8. Typical t_{RR} vs I_F at $T_J = 125\text{ }^\circ\text{C}$

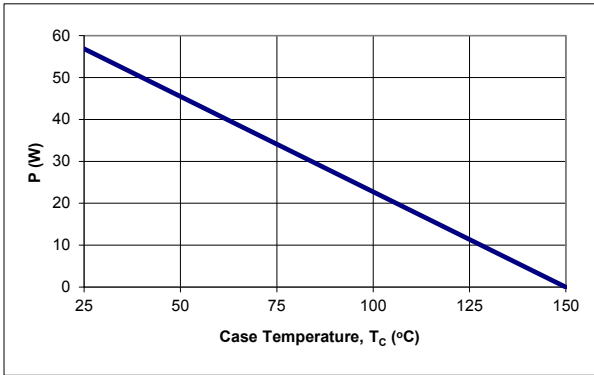

Figure 9. Power Derating Curve

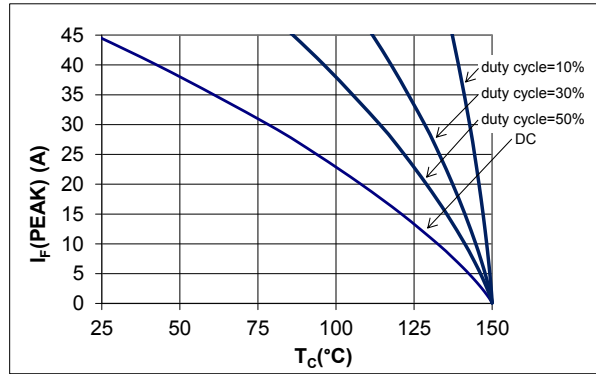

Figure 10. IF (Peak) vs TC, f = 70 kHz

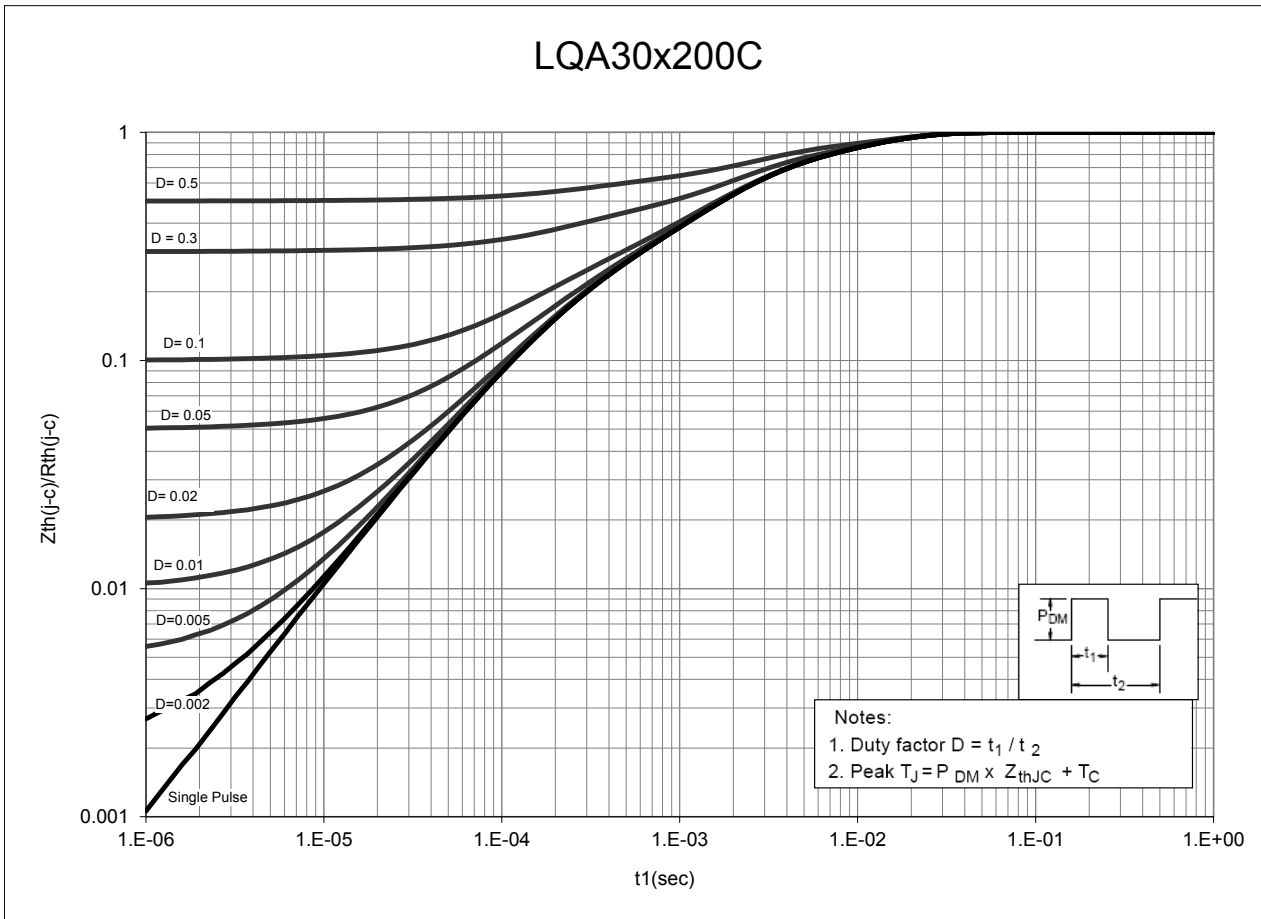
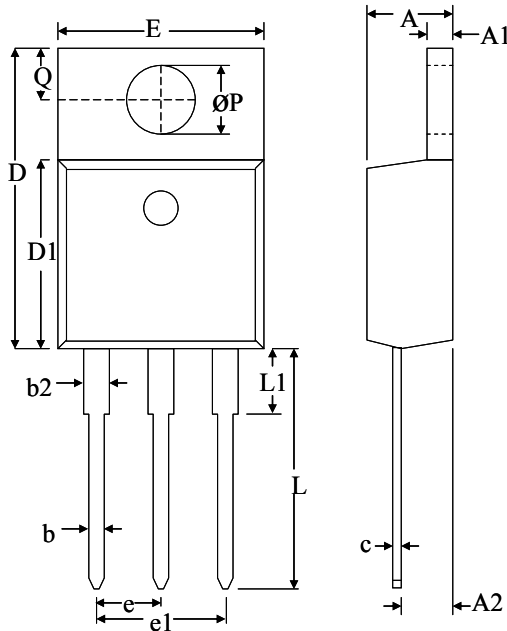

Figure 11. Normalized Maximum Transient Thermal Impedance

Dimensional Outline Drawings

TO-220AB



| Dim | Millimeters | |
|-----|-------------|-------|
| | MIN | MAX |
| A | 4.32 | 4.70 |
| A1 | 1.11 | 1.38 |
| A2 | 2.59 | 2.79 |
| b | 0.77 | 1.00 |
| b2 | 1.23 | 1.36 |
| C | 0.34 | 0.47 |
| D | 14.71 | 15.75 |
| D1 | 9.05 | 9.25 |
| E | 9.96 | 10.36 |
| e | 2.44 | 2.64 |
| e1 | 4.98 | 5.18 |
| L | 12.70 | 14.22 |
| L1 | – | 3.90 |
| ØP | 3.71 | 3.96 |
| Q | 2.54 | 2.90 |

| Mechanical Mounting Method | Maximum Torque / Pressure specification |
|-----------------------------------|---|
| Screw through hole in package tab | 1 Newton Meter (nm) or 8.8 inch-pounds (lb-in) |
| Clamp against package body | 12.3 kilogram-force per square centimeter (kgf/cm ²) or 175 lbf/in ² |

TO-263AB

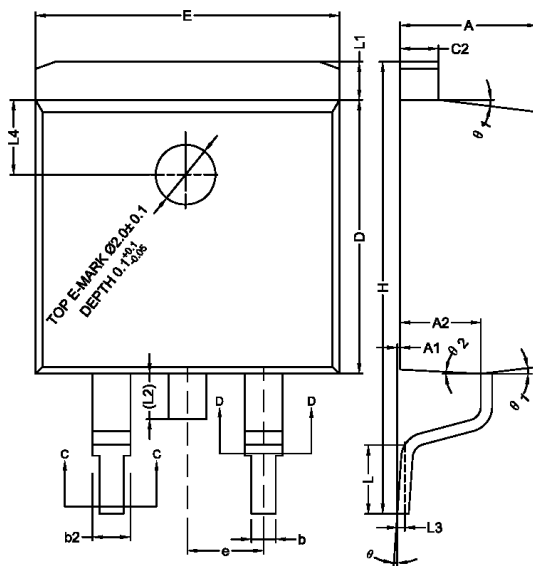

| Dim | Millimeters | |
|-----|-------------|----------|
| | MIN | MAX |
| A | 4.40 | 4.70 |
| A1 | 0.00 | 0.25 |
| A2 | 2.59 | 2.79 |
| b | 0.77 | 0.90 |
| b2 | 1.23 | 1.36 |
| c2 | 1.22 | 1.32 |
| D | 9.05 | 9.25 |
| E | 10.06 | 10.26 |
| e | 2.54 BSC | 2.54 BSC |
| H | 14.70 | 15.50 |
| L | 2.00 | 2.60 |
| L1 | 1.17 | 1.40 |
| L2 | – | 1.75 |
| L3 | 0.25 BSC | 0.25 BSC |
| L4 | 2.00 BSC | 2.00 BSC |
| Ø | 0° | 8° |
| Ø1 | 5° | 9° |
| Ø2 | 1° | 5° |

Soldering time and temperature: This product has been designed for use with high-temperature, lead-free solder. The component leads can be subjected to a maximum temperature of 300 °C, for up to 10 seconds. See Application Note AN-303, for more details.

Ordering Information

| Part Number | Package | Packing |
|-------------|----------|----------------|
| LQA30T300C | TO-220AB | 50 units/tube |
| LQA30B300C | TO-263AB | 800 units/reel |

The information contained in this document is subject to change without notice

| Revision | Notes | Date |
|----------|-----------------|-------|
| 1.0 | Initial Release | 04/13 |

For the latest updates, visit our website: www.powerint.com

Power Integrations reserves the right to make changes to its products at any time to improve reliability or manufacturability. Power Integrations does not assume any liability arising from the use of any device or circuit described herein. POWER INTEGRATIONS MAKES NO WARRANTY HEREIN AND SPECIFICALLY DISCLAIMS ALL WARRANTIES INCLUDING, WITHOUT LIMITATION, THE IMPLIED WARRANTIES OF MERCHANTABILITY, FITNESS FOR A PARTICULAR PURPOSE, AND NON-INFRINGEMENT OF THIRD PARTY RIGHTS.

PATENT INFORMATION

The products and applications illustrated herein (including transformer construction and circuits' external to the products) may be covered by one or more U.S. and foreign patents, or potentially by pending U.S. and foreign patent applications assigned to Power Integrations. A complete list of Power Integrations' patents may be found at www.powerint.com. Power Integrations grants its customers a license under certain patent rights as set forth at <http://www.powerint.com/ip.htm>.

The PI Logo, TOPSwitch, TinySwitch, LinkSwitch, LYTSwitch, DPA-Switch, PeakSwitch, CAPZero, SENZero, LinkZero, HiperPFS, HiperTFS, HiperLCS, Qspeed, EcoSmart, Clampless, E-Shield, Filterfuse, StackFET, PI Expert and PI FACTS are trademarks of Power Integrations, Inc. Other trademarks are property of their respective companies. ©Copyright 2013 Power Integrations, Inc.

Power Integrations Worldwide Sales Support Locations

WORLD HEADQUARTERS

5245 Hellyer Avenue
San Jose, CA 95138, USA.
Main: +1-408-414-9200
Customer Service:
Phone: +1-408-414-9665
Fax: +1-408-414-9765
e-mail: usasales@powerint.com

GERMANY

Lindwurmstrasse 114
80337, Munich
Germany
Phone: +49-895-527-39110
Fax: +49-895-527-39200
e-mail: eurosales@powerint.com

JAPAN

Kosei Dai-3 Building
2-12-11, Shin-Yokohama,
Kanagawa 222-0033
Japan
Phone: +81-45-471-1021
Fax: +81-45-471-3717
e-mail: japansales@powerint.com

TAIWAN

5F, No. 318, Nei Hu Rd.,
Sec. 1
Nei Hu District
Taipei 11493, Taiwan R.O.C.
Phone: +886-2-2659-4570
Fax: +886-2-2659-4550
e-mail: taiwansales@powerint.com

CHINA (SHANGHAI)

Rm 1601/1610, Tower 1,
Kerry Everbright City
No. 218 Tianmu Road West,
Shanghai, P.R.C. 200070
Phone: +86-21-6354-6323
Fax: +86-21-6354-6325
e-mail: chinasales@powerint.com

INDIA

#1, 14th Main Road
Vasanthanagar
Bangalore-560052
India
Phone: +91-80-4113-8020
Fax: +91-80-4113-8023
e-mail: indiasales@powerint.com

KOREA

RM 602, 6FL
Korea City Air Terminal B/D,
159-6
Samsung-Dong, Kangnam-Gu,
Seoul, 135-728 Korea
Phone: +82-2-2016-6610
Fax: +82-2-2016-6630
e-mail: koreasales@powerint.com

EUROPE HQ

1st Floor, St. James's House
East Street, Farnham
Surrey GU9 7TJ
United Kingdom
Phone: +44 (0) 1252-730-141
Fax: +44 (0) 1252-727-689
e-mail: eurosales@powerint.com

CHINA (SHENZHEN)

3rd Floor, Block A,
Zhongtong International Business
Center, No. 1061, Xiang Mei Rd,
FuTian District, ShenZhen,
China, 518040
Phone: +86-755-8379-3243
Fax: +86-755-8379-5828
e-mail: chinasales@powerint.com

ITALY

Via Milanese 20, 3rd Fl.
20099 Sesto San Giovanni
(MI) Italy
Phone: +39-024-550-8701
Fax: +39-028-928-6009
e-mail: eurosales@powerint.com

SINGAPORE

51 Newton Road,
#19-01/05 Goldhill Plaza
Singapore, 308900
Phone: +65-6358-2160
Fax: +65-6358-2015
e-mail: singaporesales@powerint.com

APPLICATIONS HOTLINE

World Wide +1-408-414-9660

APPLICATIONS FAX

World Wide +1-408-414-9760



Компания «ЭлектроПласт» предлагает заключение долгосрочных отношений при поставках импортных электронных компонентов на взаимовыгодных условиях!

Наши преимущества:

- Оперативные поставки широкого спектра электронных компонентов отечественного и импортного производства напрямую от производителей и с крупнейших мировых складов;
- Поставка более 17-ти миллионов наименований электронных компонентов;
- Поставка сложных, дефицитных, либо снятых с производства позиций;
- Оперативные сроки поставки под заказ (от 5 рабочих дней);
- Экспресс доставка в любую точку России;
- Техническая поддержка проекта, помощь в подборе аналогов, поставка прототипов;
- Система менеджмента качества сертифицирована по Международному стандарту ISO 9001;
- Лицензия ФСБ на осуществление работ с использованием сведений, составляющих государственную тайну;
- Поставка специализированных компонентов (Xilinx, Altera, Analog Devices, Intersil, Interpoint, Microsemi, Aeroflex, Peregrine, Syfer, Eurofarad, Texas Instrument, Miteq, Cobham, E2V, MA-COM, Hittite, Mini-Circuits, General Dynamics и др.);

Помимо этого, одним из направлений компании «ЭлектроПласт» является направление «Источники питания». Мы предлагаем Вам помощь Конструкторского отдела:

- Подбор оптимального решения, техническое обоснование при выборе компонента;
- Подбор аналогов;
- Консультации по применению компонента;
- Поставка образцов и прототипов;
- Техническая поддержка проекта;
- Защита от снятия компонента с производства.



Как с нами связаться

Телефон: 8 (812) 309 58 32 (многоканальный)

Факс: 8 (812) 320-02-42

Электронная почта: org@eplast1.ru

Адрес: 198099, г. Санкт-Петербург, ул. Калинина, дом 2, корпус 4, литера А.