

ISL55033

400MHz Slew Rate Enhanced, Rail-to-Rail Output Gain Block

FN6346
Rev 1.00
June 29, 2015

The **ISL55033** is a triple rail-to-rail output gain block with a -3dB bandwidth of 400MHz and slew rate of 2350V/ μ s into a 150 Ω load. The ISL55033 has a fixed gain of +2. The inputs are capable of sensing ground. The outputs are capable of swinging to 0.45V to either rail through a 150 Ω resistor connected to $V+/2$.

The ISL55033 is designed for general purpose video applications. The part includes a fast-acting global disable/power-down function.

The ISL55033 is available in a 12 Ld TQFN package. Operation is specified over the -40 $^{\circ}$ C to +85 $^{\circ}$ C temperature range.

Features

- 400MHz -3dB bandwidth
- 2350V/ μ s typ slew rate, $R_L = 150\Omega$ to $V+/2$
- Single-supply operation from +3V to +5.5V
- Rail-to-rail output
- Input ground sensing
- Fast 25ns disable time
- Pb-free (RoHS compliant)

Applications

- Video amplifiers
- Set-top boxes
- Video distribution

Pin Configuration

ISL55033
(12 LD TQFN)
TOP VIEW

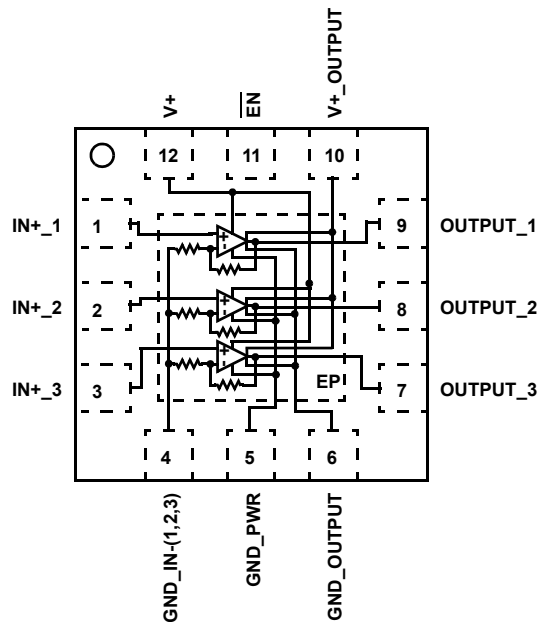

EACH CHANNEL
 $A_V = +2$

Pin Descriptions

PIN NUMBER	PIN NAME	EQUIVALENT CIRCUIT	DESCRIPTION
1	IN+_1	Circuit 1	Amplifier 1 noninverting input
2	IN+_2	Circuit 1	Amplifier 2 noninverting input
3	IN+_3	Circuit 1	Amplifier 3 noninverting input
4	GND_IN-(1, 2, 3)	Circuit 4	Common input for amplifiers 1, 2, 3 inverting inputs
5	GND_PWR	Circuits 1, 2, 4, 5	Power supply ground. This is also the potential of the exposed metal pad on the package bottom.
6	GND_OUTPUT	Circuit 3	Output power supply ground
7	OUTPUT_3	Circuit 3	Amplifier 3 output
8	OUTPUT_2	Circuit 3	Amplifier 2 output
9	OUTPUT_1	Circuit 3	Amplifier 1 output
10	V+_OUTPUT	Circuit 3	Output power supply
11	$\overline{\text{EN}}$	Circuit 2	Enable pin with internal pull-down: Logic "1" selects the disabled state; Logic "0" selects the enabled state
12	V+	Circuits 1, 2, 4	Positive power supply
EP	EP	Circuit 5	Package's exposed thermal pad. Connect to GND_PWR.

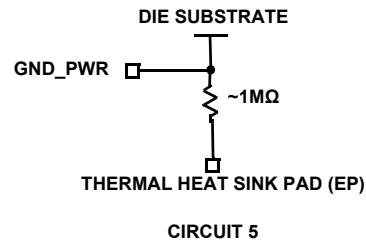
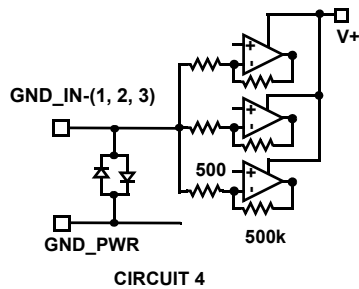
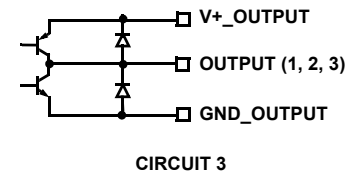
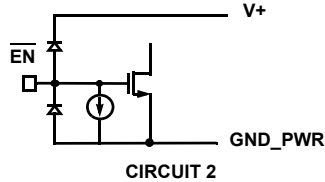
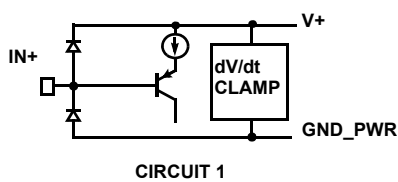

Ordering Information

PART NUMBER (Note 1, 2, 3)	PART MARKING	TEMP RANGE (°C)	PACKAGE (RoHS Compliant)	PKG. DWG. #
ISL55033IRTZ	5033	-40 to +85	12 Ld TQFN	L12.3x3A

NOTES:

1. Add "-T*" suffix for tape and reel. Please refer to [TB347](#) for details on reel specifications.
2. These Intersil Pb-free plastic packaged products employ special Pb-free material sets, molding compounds/die attach materials, and 100% matte tin plate plus anneal (e3 termination finish, which is RoHS compliant and compatible with both SnPb and Pb-free soldering operations). Intersil Pb-free products are MSL classified at Pb-free peak reflow temperatures that meet or exceed the Pb-free requirements of IPC/JEDEC J STD-020.
3. For Moisture Sensitivity Level (MSL), please see product information page for [ISL55033](#). For more information on MSL, please see tech brief [TB363](#).

Absolute Maximum Ratings ($T_A = +25^\circ\text{C}$)

Supply Voltage from V+ to GND	5.75V
Supply Turn-on Voltage Slew Rate	1V/ μs
$\overline{\text{EN}}$ Input Current	4mA
Input Voltage	(V+) + 0.3V to GND - 0.3V
Continuous Output Current	40mA
ESD Rating:	
Human Body Model	2.5kV
Machine Model	300V
Charge Device Model	1.5kV

Thermal Information

Thermal Resistance (Typical)	θ_{JA} ($^\circ\text{C}/\text{W}$)	θ_{JC} ($^\circ\text{C}/\text{W}$)
12 Ld TQFN Package (Notes 4, 5)	57	10
Storage Temperature	-65 $^\circ\text{C}$ to +125 $^\circ\text{C}$	
Pb-free Reflow Profile	see TB493	

Operating Conditions

Ambient Operating Temperature Range (T_A)	-40 $^\circ\text{C}$ to +85 $^\circ\text{C}$
Maximum Operating Junction Temperature (T_J)	+125 $^\circ\text{C}$

CAUTION: Do not operate at or near the maximum ratings listed for extended periods of time. Exposure to such conditions may adversely impact product reliability and result in failures not covered by warranty.

- θ_{JA} is measured with the component mounted on a high effective thermal conductivity test board in free air. See Tech Brief [TB379](#) for details.
- For θ_{JC} , the "case temp" location is the center of the exposed metal pad on the package underside.

Electrical Specifications $V_+ = V_{+_OUTPUT} = 5\text{V}$, $T_A = +25^\circ\text{C}$, $R_L = 1\text{k}\Omega$ to $V_+/2$, $V_{IN} = 0.1\text{VDC}$, unless otherwise specified.

PARAMETER	DESCRIPTION	TEST CONDITIONS	MIN (Note 7)	TYP	MAX (Note 7)	UNIT
INPUT CHARACTERISTICS						
V_{OS}	Output Offset Voltage	(Note 6)	-9	-1	9	mV
TCV_{OS}	Offset Voltage Temperature Coefficient	Measured from -40 $^\circ\text{C}$ to +85 $^\circ\text{C}$		-3		$\mu\text{V}/^\circ\text{C}$
I_B	Input Bias Current	$V_{IN} = 0\text{V}$	-8.5	-6		μA
R_{IN}	Input Resistance			7		M Ω
C_{IN}	Input Capacitance			0.5		pF
OUTPUT CHARACTERISTICS						
A_{CL}	Closed Loop Gain	$V_{OUT} = 0.5\text{V}$ to 4V , $R_L = 150\Omega$	1.97	1.99	2.014	V/V
R_{OUT}	Output Resistance	$A_V = +2$		30		m Ω
V_{OH}	Positive Output Voltage Swing	$R_L = 1\text{k}\Omega$ to 2.5V	4.7	4.75		V
		$R_L = 150\Omega$ to 2.5V	4.5	4.55		V
V_{OL}	Negative Output Voltage Swing	$R_L = 1\text{k}\Omega$ to 2.5V		27	50	mV
		$R_L = 150\Omega$ to 2.5V		130	200	mV
I_{SC} (source)	Output Short-circuit Current	$R_L = 10\Omega$ to GND, $V_{IN} = 1.5\text{V}$	50			mA
I_{SC} (sink)	Output Short-circuit Current	$R_L = 10\Omega$ to + 2.5V , $V_{IN} = 0\text{V}$	50			mA
POWER SUPPLY						
PSRR	Power Supply Rejection Ratio	$V_+ = 3\text{V}$ to 5.5V , $R_L = \text{Open}$	65	83		dB
I_{S-ON}	Supply Current - Enabled	$V_{IN} = 0.1\text{V}$, $R_L = \text{Open}$	18.5	21.3	24.5	mA
I_{S-OFF}	Supply Current - All Amplifiers Disabled	$R_L = \text{Open}$	275	486	900	μA
ENABLE						
t_{EN}	Enable Time	$R_L = 150\Omega$, $V_{IN} = 0.5\text{V}$		250		ns
t_{DS}	Disable Time	$R_L = 150\Omega$, $V_{IN} = 0.5\text{V}$		25		ns
V_{IL-ENB}	$\overline{\text{EN}}$ Pin Low Voltage for Power-up			0.8		V
V_{IH-ENB}	$\overline{\text{EN}}$ Pin High Voltage for Shut-Down			2		V
I_{IH-ENB}	$\overline{\text{EN}}$ Pin Input Current High	$V_{\overline{\text{EN}}} = 5\text{V}$	1	7	15	μA
I_{IL-ENB}	$\overline{\text{EN}}$ Pin Input Current Low	$V_{\overline{\text{EN}}} = 0\text{V}$	-10	2	10	μA

Electrical Specifications $V_+ = V_{+_OUTPUT} = 5V$, $T_A = +25^\circ C$, $R_L = 1k\Omega$ to $V_+/2$, $V_{IN} = 0.1VDC$, unless otherwise specified. (Continued)

PARAMETER	DESCRIPTION	TEST CONDITIONS	MIN (Note 7)	TYP	MAX (Note 7)	UNIT
AC PERFORMANCE						
BW	-3dB Bandwidth	$V_{OUT} = 100mV_{P-P}$, $R_L = 150\Omega$, $C_L = 2pF$, $V_{IN} = 1.0VDC$		400		MHz
BW	$\pm 0.1dB$ Bandwidth	$V_{OUT} = 100mV_{P-P}$, $R_L = 150\Omega$, $C_L = 2pF$		60		MHz
Peak	Gain Peaking	$V_{OUT} = 100mV_{P-P}$, $R_L = 150\Omega$, $C_L = 3.2pF$		1.5		dB
dG	Differential Gain	$V_{IN} = 0.1V$ to $2.0V$, $V_{OUT} = 100mV_{P-P}$, $f = 3.58MHz$, $R_L = 150\Omega$		0.012		%
dP	Differential Phase			0.11		°
e_{N-OUT}	Output Voltage Noise Density	$f = 10kHz$		35		nV/\sqrt{Hz}
i_N	Input Current Noise Density	$f = 10kHz$		2.9		pA/\sqrt{Hz}
ISO	Off-state Isolation $f_0 = 10MHz$	$V_{IN} = 0.8VDC + 1V_{P-P}$, $C_L = 2pF$, $R_L = 150\Omega$		-80		dB
X-TALK	Channel-to-channel Crosstalk, $f_0 = 10MHz$	$V_{IN} = 0.8VDC + 1V_{P-P}$, $C_L = 2pF$, $R_L = 150\Omega$		-65		dB
PSRR	Power Supply Rejection Ratio $f_0 = 10MHz$	$V_{IN} = 0.2VDC$, $V_{SOURCE} = 1V_{P-P}$, $C_L = 2pF$, $R_L = 150\Omega$		-55		dB
TRANSIENT RESPONSE						
SR	Slew Rate 25% to 75%	$R_L = 150\Omega$, $V_{OUT} = 0.5V$ to $3.5V$		2350		$V/\mu s$
t_r , t_f Large Signal	Rise Time, t_r 20% to 80%	$V_{OUT} = 3V_{P-P}$, $R_L = 150\Omega$, $C_L = 2pF$		0.8		ns
	Fall Time, t_f 80% to 20%			0.7		ns
	Rise Time, t_r 20% to 80%	$V_{OUT} = 2V_{P-P}$, $R_L = 150\Omega$, $C_L = 2pF$		0.6		ns
	Fall Time, t_f 80% to 20%			0.6		ns
t_r , t_f Small Signal	Rise Time, t_r 20% to 80%	$V_{OUT} = 100mV_{P-P}$, $R_L = 150\Omega$, $C_L = 2pF$		0.55		ns
	Fall Time, t_f 80% to 20%			0.55		ns
OS	Overshoot	100mV step		13		%
t_{PD}	Propagation Delay	100mV step; $R_L = 150\Omega$		1		ns
t_S	0.1% Settling Time	2V step		65		ns

NOTES:

- V_{OS} is extrapolated from 2 output voltage measurements, with $V_{IN} = 62.5mV$ and $V_{IN} = 125mV$, $R_L = 1k$.
- Parameters with MIN and/or MAX limits are 100% tested at $+25^\circ C$, unless otherwise specified. Temperature limits established by characterization and are not production tested.

Typical Performance Curves

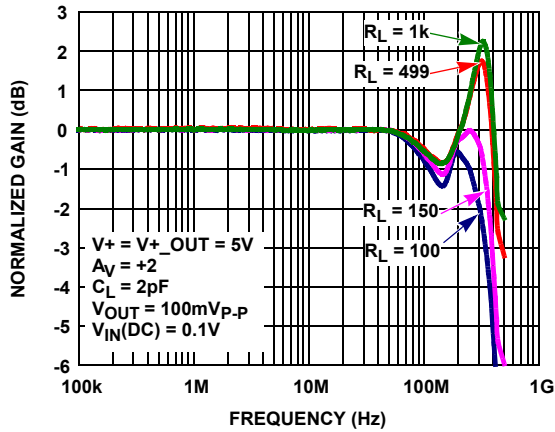

FIGURE 1. GAIN vs FREQUENCY FOR VARIOUS R_{LOAD}

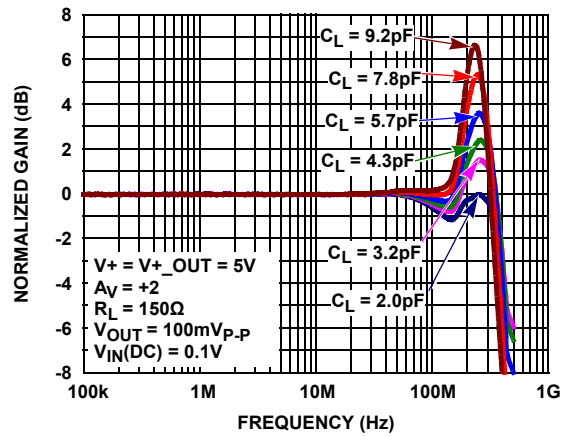

FIGURE 2. GAIN vs FREQUENCY FOR VARIOUS C_{LOAD}

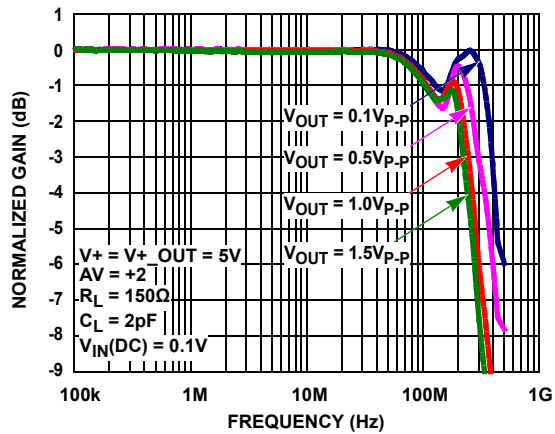

FIGURE 3. GAIN vs FREQUENCY FOR VARIOUS V_{OUT}

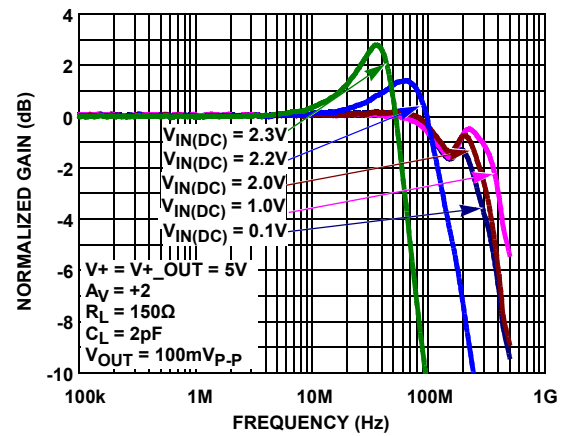

FIGURE 4. GAIN vs FREQUENCY FOR VARIOUS DC INPUT VOLTAGES

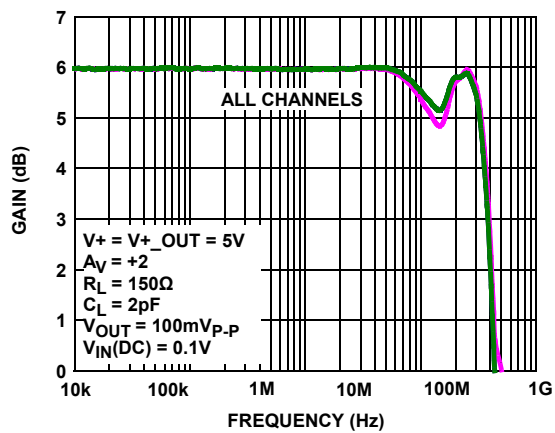

FIGURE 5. GAIN vs FREQUENCY - ALL CHANNELS

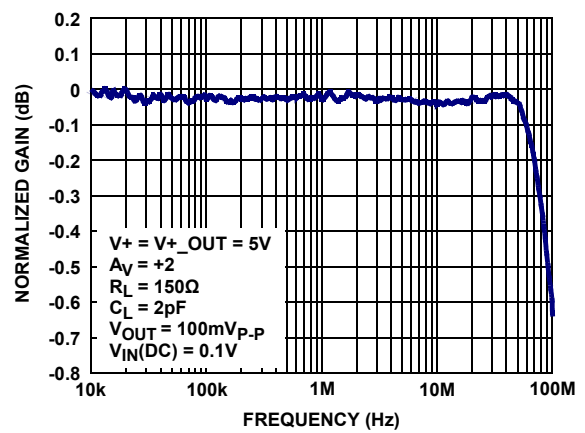

FIGURE 6. 0.1 dB GAIN FLATNESS

Typical Performance Curves (Continued)

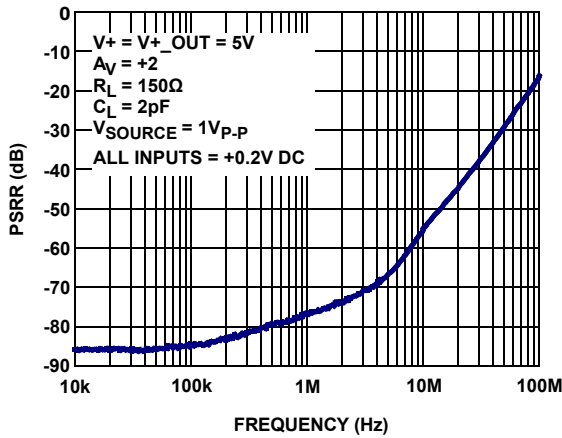

FIGURE 7. PSRR vs FREQUENCY

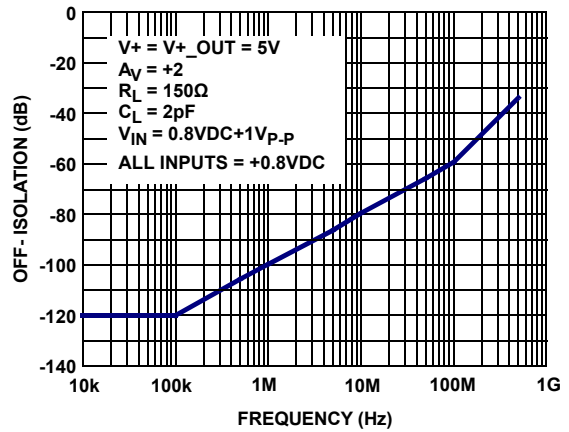

FIGURE 8. OFF-ISOLATION vs FREQUENCY

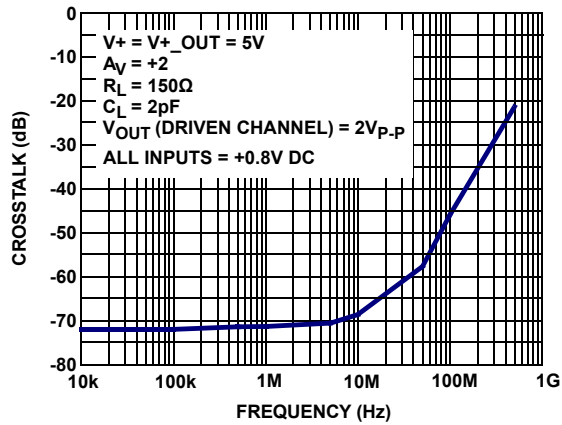

FIGURE 9. CHANNEL-TO-CHANNEL CROSSTALK vs FREQUENCY

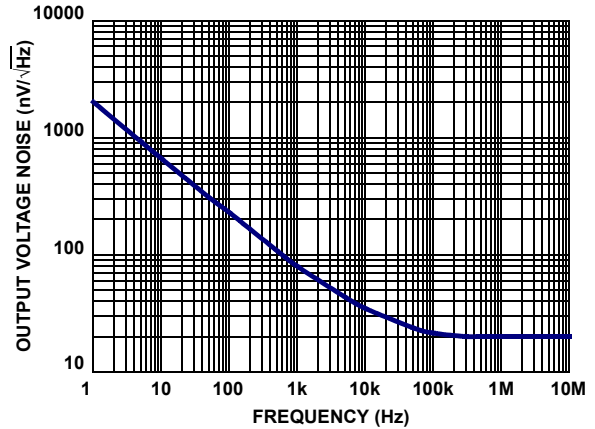

FIGURE 10. OUTPUT VOLTAGE NOISE DENSITY vs FREQUENCY

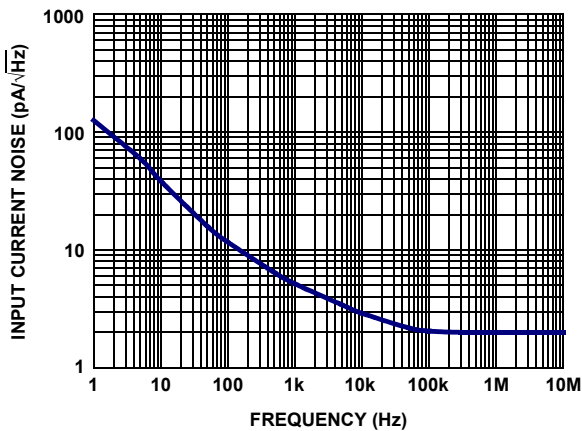

FIGURE 11. INPUT CURRENT NOISE DENSITY vs FREQUENCY

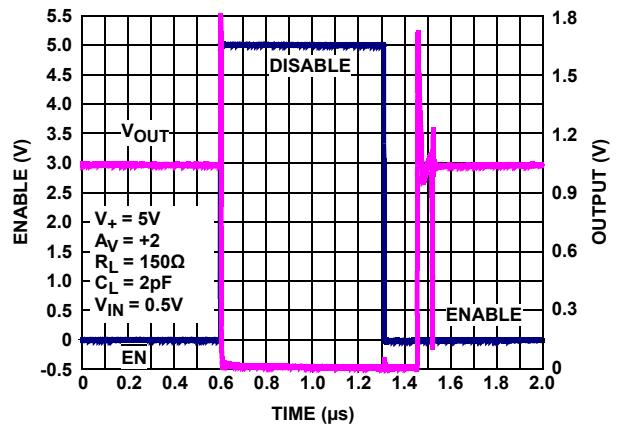

FIGURE 12. ENABLE/DISABLE TIMING

Typical Performance Curves (Continued)

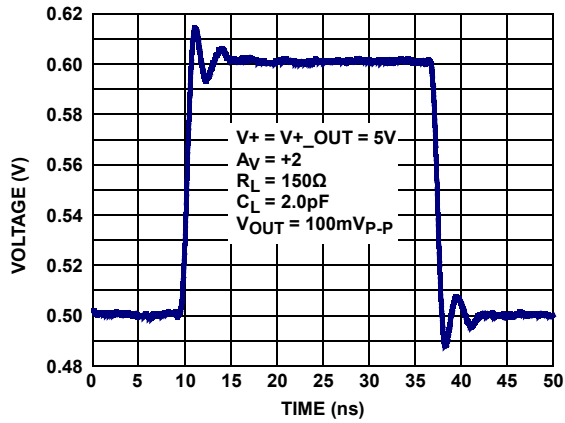

FIGURE 13. SMALL SIGNAL STEP RESPONSE

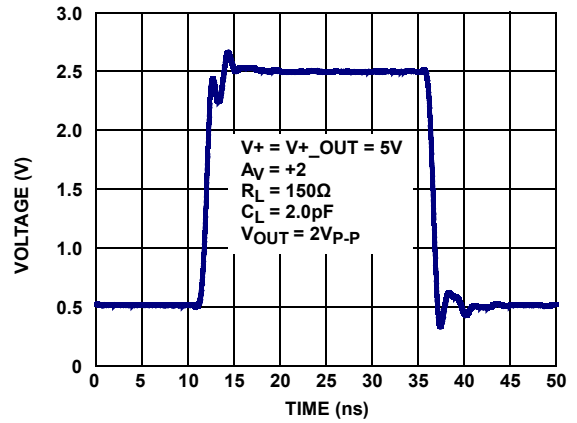

FIGURE 14. LARGE SIGNAL (2V_{p.p}) STEP RESPONSE

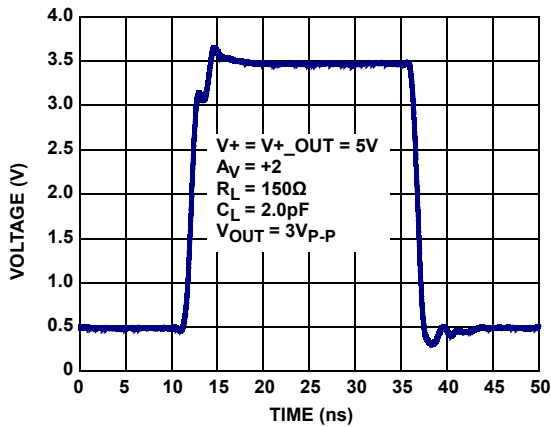

FIGURE 15. LARGE SIGNAL (3V_{p.p}) STEP RESPONSE

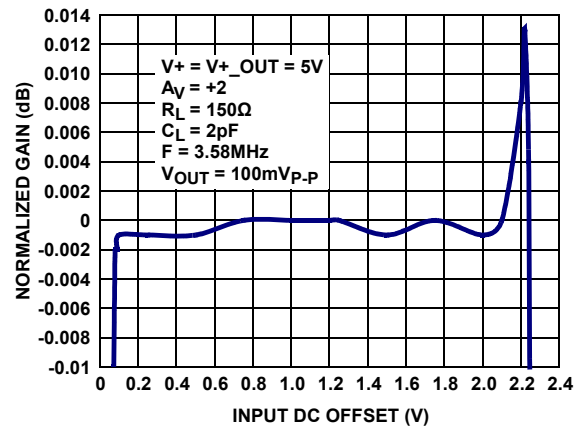

FIGURE 16. DIFFERENTIAL GAIN

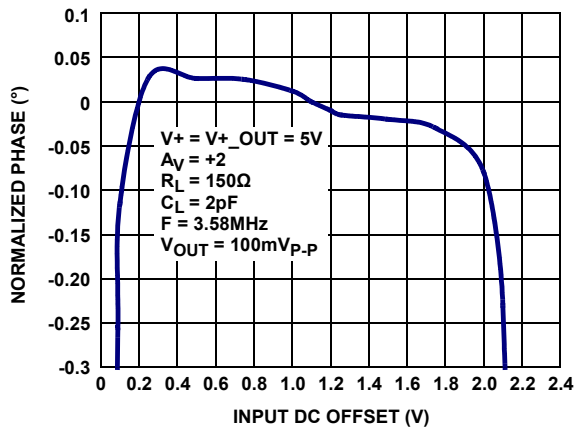

FIGURE 17. DIFFERENTIAL PHASE

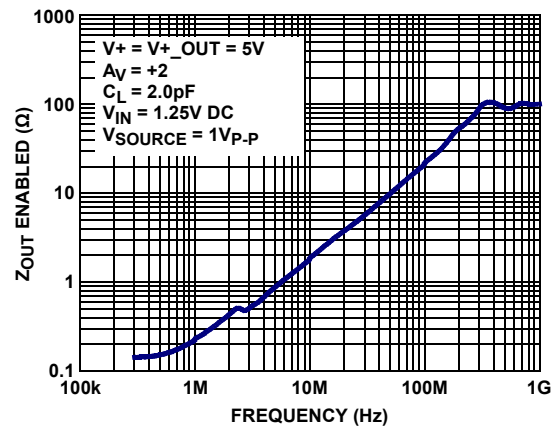

FIGURE 18. Z_{OUT} (ENABLED) vs FREQUENCY

Typical Performance Curves (Continued)

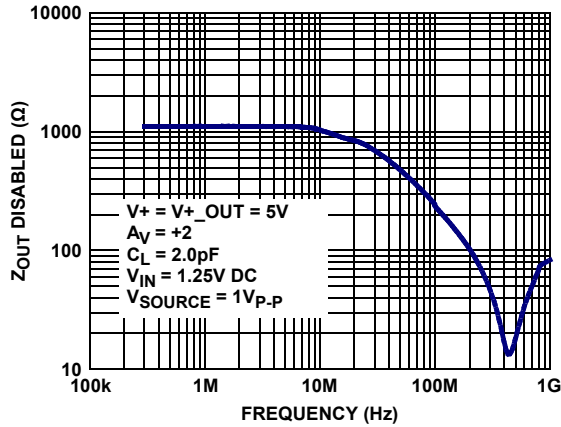

FIGURE 19. Z_{OUT} (DISABLED) vs FREQUENCY

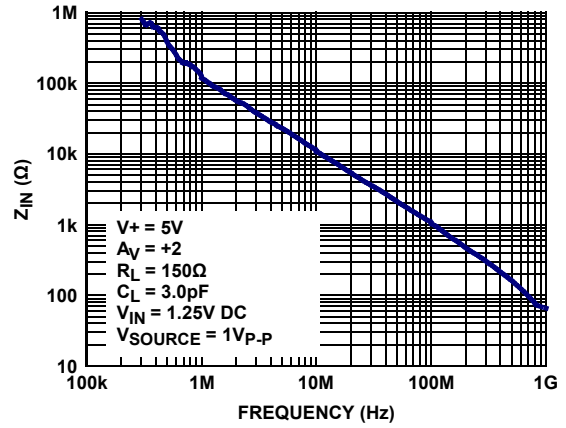

FIGURE 20. Z_{IN} vs FREQUENCY

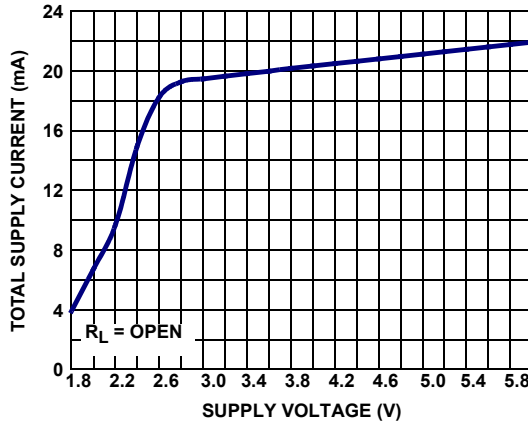

FIGURE 21. SUPPLY CURRENT vs SUPPLY VOLTAGE

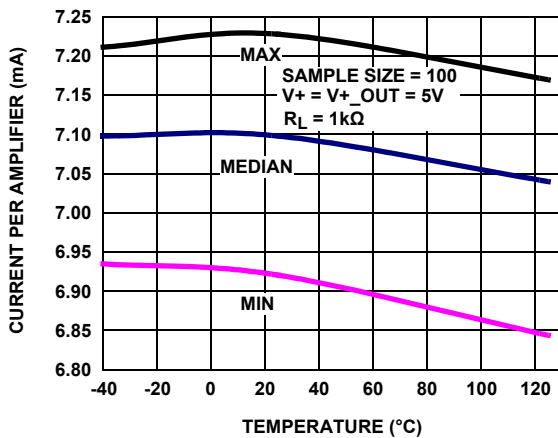

FIGURE 22. ENABLED SUPPLY CURRENT vs TEMPERATURE

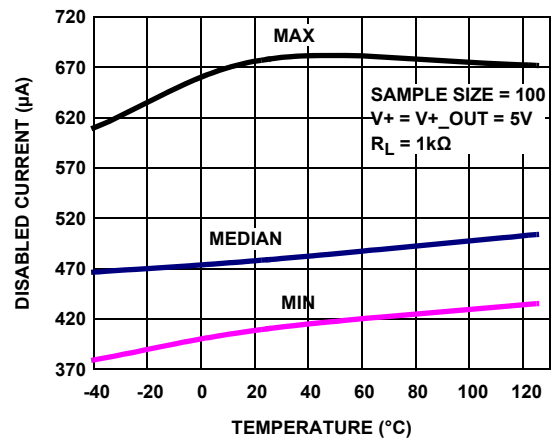

FIGURE 23. DISABLED SUPPLY CURRENT vs TEMPERATURE

Typical Performance Curves (Continued)

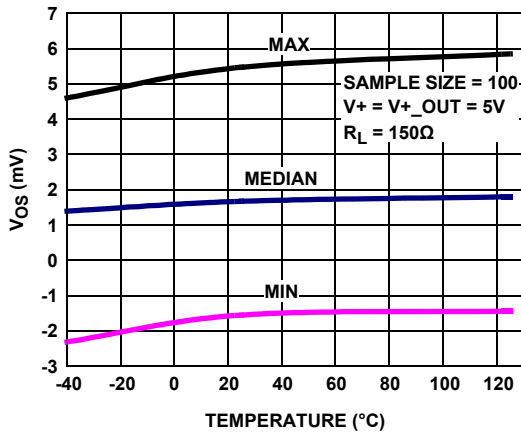

FIGURE 24. OUTPUT OFFSET VOLTAGE V_{OS} vs TEMPERATURE

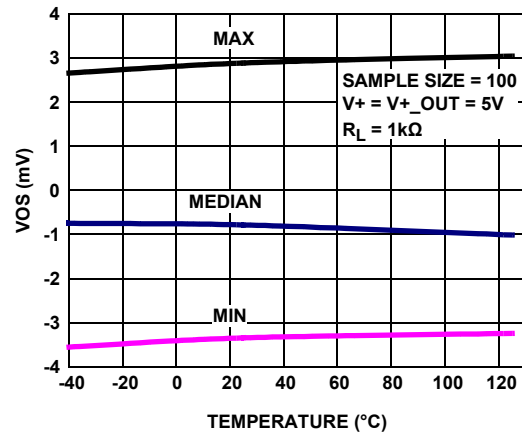

FIGURE 25. OUTPUT OFFSET VOLTAGE V_{OS} vs TEMPERATURE

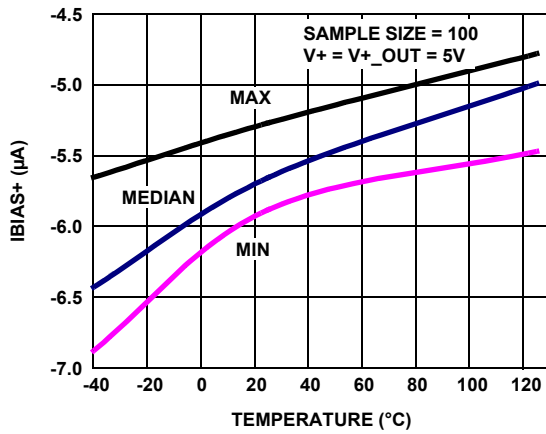

FIGURE 26. I_{BIAS} vs TEMPERATURE

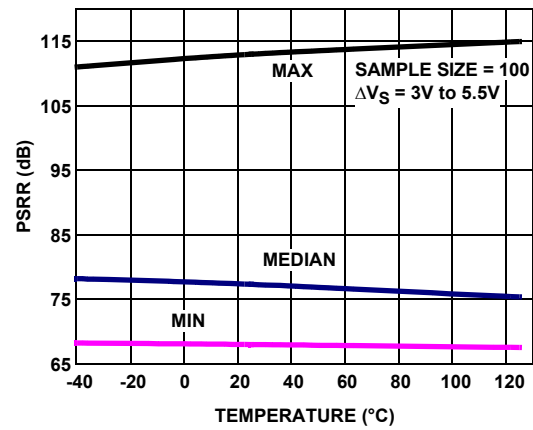

FIGURE 27. PSRR vs TEMPERATURE

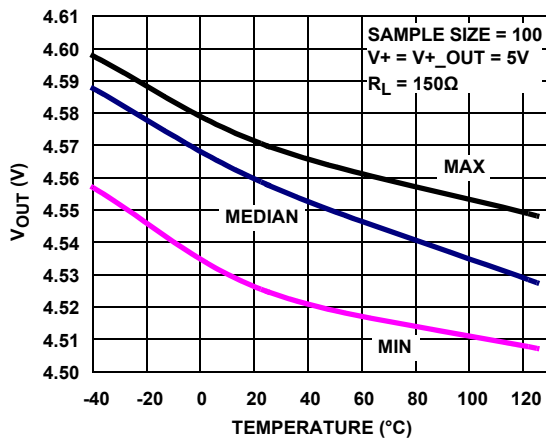

FIGURE 28. V_{OUT} HIGH vs TEMPERATURE

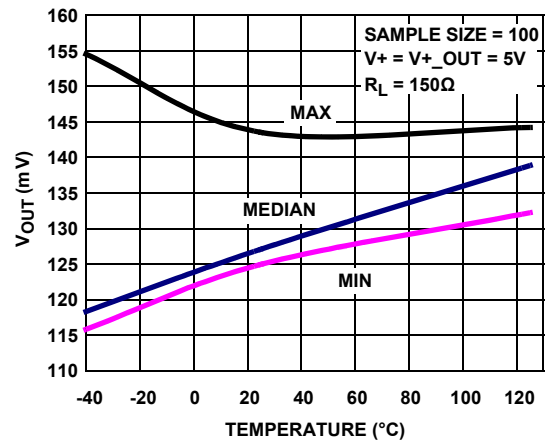

FIGURE 29. V_{OUT} LOW vs TEMPERATURE

Typical Performance Curves (Continued)

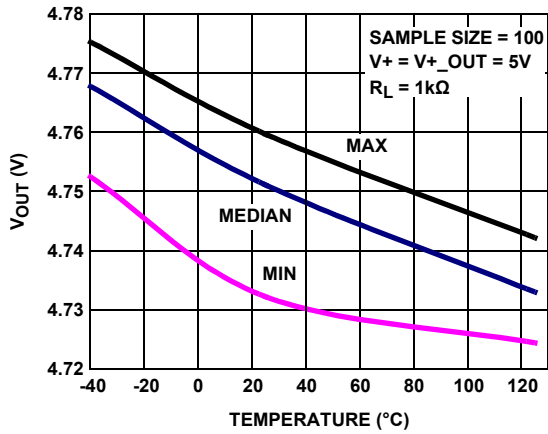

FIGURE 30. V_{OUT} HIGH vs TEMPERATURE

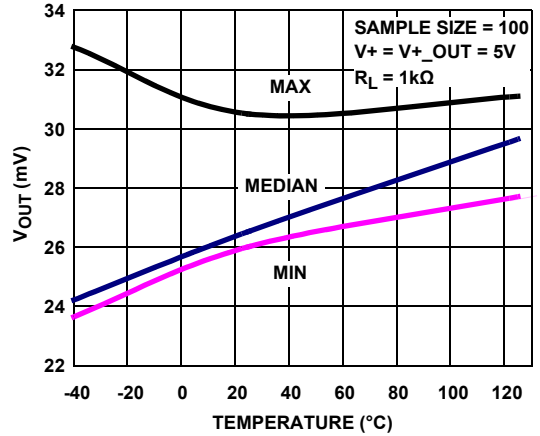

FIGURE 31. V_{OUT} LOW vs TEMPERATURE

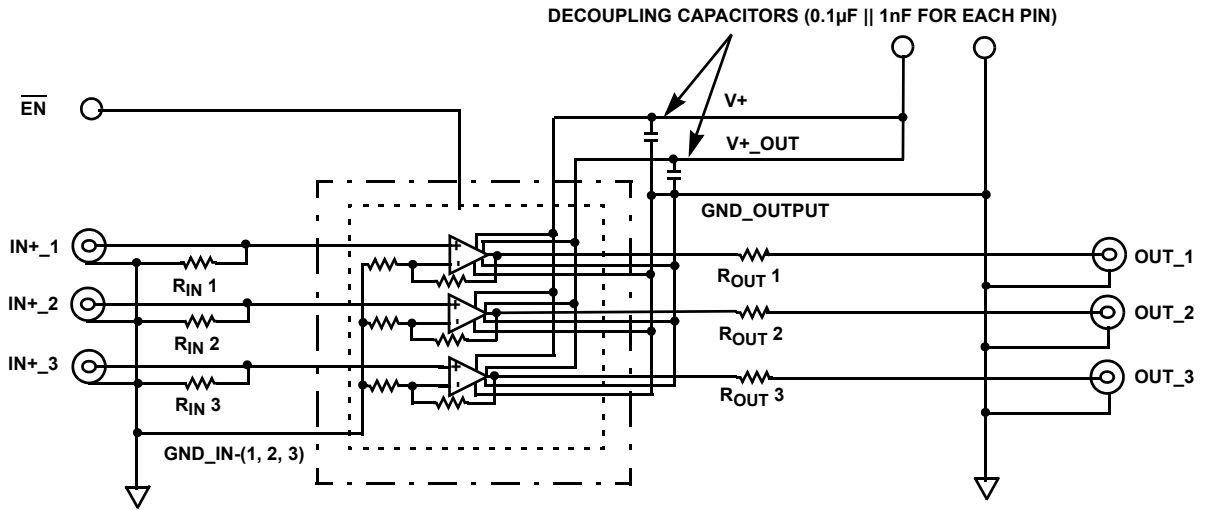

FIGURE 32. BASIC APPLICATION CIRCUIT

Application Information

General

The ISL55033 single supply, fixed gain, triple amplifier is intended for use in a variety of video and other high speed applications. The device features a ground-sensing PNP input stage and a bipolar rail-to-rail output stage. The three amplifiers have an internally fixed gain of 2 and share a single enable pin as shown in [Figure 32](#).

Ground Connections

For the best isolation performance and crosstalk rejection, all GND pins must connect directly to the GND plane. In addition, the electrically conductive thermal pad (EP) must also connect directly to ground.

Power Considerations

Separate V+ power supply and GND pins for the input and output stages are provided to maximize PSRR. Providing separate power pins provides a way to prevent high speed transient currents in the output stage from bleeding into the sensitive amplifier input and gain stages. To maximize crosstalk isolation, each power supply pin should have its own decoupling capacitors connected as close to the pin as possible as shown in [Figure 32](#) (0.1 μ F in parallel with 1nF recommended).

The ESD protection circuits use internal diodes from all pins to the V+ and ground pins. In addition, a dV/dt-triggered clamp is connected between the V+ and V- pins, as shown in Equivalent Circuit 1 on [page 2](#). The dV/dt triggered clamp imposes a maximum supply turn-on slew rate of 1V/ μ s. Damaging currents can flow for power supply slew rates in excess of 1V/ μ s, such as during hot plugging. Under these conditions, additional methods should be employed to ensure the maximum supply slew rate is not exceeded.

Single Supply Input/Output Considerations

For best performance, the input signal voltage range should be maintained between 0.1V to 2.1V. These input limits correspond to an output voltage range of 0.2V to 4.2V and define the limits of linear operation. [Figure 4](#) shows the frequency response versus the input DC voltage level. [Figures 16](#) and [17](#) show the differential gain-phase performance over the input range of 0V to 2.4V operating into a 150 Ω load. The 0.1V to 2.1V input levels corresponds to a 0.2V to 4.2V output levels, which define the minimum and maximum range of output linear operation.

Composite video with sync requires care to ensure that the negative sync tip voltage (typically -300mV) is properly level-shifted up into the ISL55033 input linear operating region of +0.1V to 2.1V. The high input impedance enables AC coupling using low values of coupling capacitance with relatively high input voltage divider resistances.

EN and Power-down States

The $\overline{\text{EN}}$ pin is active low. An internal pull-down resistor ensures the device will be active with no connection to the $\overline{\text{EN}}$ pin. The power-down state is established within approximately 25ns, if a logic high (>2V) is placed on the $\overline{\text{EN}}$ pin. In the power-down state, supply current is reduced significantly by shutting the three

amplifiers off. The output presents a relatively high impedance (~2k Ω) to the output pin. Multiplexing several outputs together is possible using the enable/disable function as long as the application can tolerate the limited power-down output impedance.

Limiting the Output Current

No output short-circuit current limit exists on these parts. All applications need to limit the output current to less than 40mA. Adequate thermal heat sinking of the parts is also required.

PC Board Layout

The AC performance of this circuit depends greatly on the care taken in designing the PC board. The following are recommendations to achieve optimum high frequency performance from your PC board.

- The use of low inductance components, such as chip resistors and chip capacitors, is strongly recommended.
- Minimize signal trace lengths. Trace inductance and capacitance can easily limit circuit performance. Avoid sharp corners. Use rounded corners when possible. Vias in the signal lines add inductance at high frequency and should be avoided. PCB traces greater than 1" begin to exhibit transmission line characteristics with signal rise/fall times of 1ns or less. High frequency performance may be degraded for traces greater than one inch, unless controlled impedance (50 Ω or 75 Ω) strip lines or microstrips are used.
- Match channel-to-channel analog I/O trace lengths and layout symmetry. This will minimize propagation delay mismatches.
- Maximize use of AC decoupled PCB layers. All signal I/O lines should be routed over continuous ground planes (i.e. no split planes or PCB gaps under these lines). Avoid vias in the signal I/O lines.
- Use proper value and location of termination resistors. Input termination resistors should be as close to the input terminal as possible and output termination resistors as close to the receiving device as possible.
- When testing, use good quality connectors and cables, matching cable types and keeping cable lengths to a minimum.
- A minimum of two, high frequency, power supply decoupling capacitors (100pF, 0.1 μ F), on each V+ pin, are recommended as close to the devices as possible. Avoid vias between the capacitor and the device because vias add unwanted inductance. Larger capacitors (e.g., electrolytics) can be farther away. When vias are required in a layout, they should be routed as far away from the device as possible.

The QFN Package Requires Additional PCB Layout Rules for the Thermal Pad

The thermal pad (EP) is electrically connected to power supply ground (GND_PWR) through the high resistance IC substrate. Its primary function is to provide heat sinking for the IC. However, because of the connection to the power ground pins through the substrate, the thermal pad must be tied to the power supply ground to prevent unwanted current flow through the thermal

pad. Maximum AC performance is achieved if the thermal pad has good contact to the IC ground pins. Heat sinking requirements can be satisfied using thermal vias directly beneath the thermal pad to a heat dissipating layer of a square at least 1" on a side. Fill the PCB pad under the EP with vias and connect those vias to a substantial ground plane. Reference [TB379](#), section 3) on page 2 and Appendix A, or JEDEC JESD51-5, for more information.

Revision History

The revision history provided is for informational purposes only and is believed to be accurate, but not warranted. Please go to web to make sure you have the latest revision.

DATE	REVISION	CHANGE
June 29, 2015	FN6346.1	<ul style="list-style-type: none"> -Pin Descriptions table on page 2, updated equivalent circuit as follows: Pin number 4: from Circuit 1 to Circuit 4. Pin number 5: from Circuit 4 to Circuits 1, 2, 4, 5 and added sentence to the description. Pin number 6: from Circuit 4 to Circuit 3. Pin number 10: from Circuit 4 to Circuit 3. Pin number 12: from Circuit 4 to Circuits 1, 2, 4. Added EP details to the table. Updated Circuits 3 and 4 figure. -Ordering information table on page 2: Removed ISL55033EVAL1Z. - Ordering information table on page 2: Added MSL note. -Thermal Information table on page 3, added "Theta jc" and reference "Note 5". -"Electrical Specification" table on page 3, test condition from V+ = 5V to V+_VOUT = 5V. -Electrical Specification" table on page 3, under enable section changed "Parameter" name "VIH-ENB" to "VIL-ENB" for the 0.8V typical value and changed "Parameter" name "VIL-ENB" to "VIH-ENB" for the 2V typical value. -"PC Board Layout" on page 11, changed reference from "0.01μF" cap to "0.1μF", removed paragraph referencing "NIC" pins. -updated "The QFN Package Requires Additional PCB Layout Rules for the Thermal Pad" on page 12 paragraph. - Added revision history and about Intersil verbiage.

About Intersil

Intersil Corporation is a leading provider of innovative power management and precision analog solutions. The company's products address some of the largest markets within the industrial and infrastructure, mobile computing and high-end consumer markets.

For the most updated datasheet, application notes, related documentation and related parts, please see the respective product information page found at www.intersil.com.

You may report errors or suggestions for improving this datasheet by visiting www.intersil.com/ask.

Reliability reports are also available from our website at www.intersil.com/support

© Copyright Intersil Americas LLC 2008-2015. All Rights Reserved.

All trademarks and registered trademarks are the property of their respective owners.

For additional products, see www.intersil.com/en/products.html

Intersil products are manufactured, assembled and tested utilizing ISO9001 quality systems as noted in the quality certifications found at www.intersil.com/en/support/qualandreliability.html

Intersil products are sold by description only. Intersil may modify the circuit design and/or specifications of products at any time without notice, provided that such modification does not, in Intersil's sole judgment, affect the form, fit or function of the product. Accordingly, the reader is cautioned to verify that datasheets are current before placing orders. Information furnished by Intersil is believed to be accurate and reliable. However, no responsibility is assumed by Intersil or its subsidiaries for its use; nor for any infringements of patents or other rights of third parties which may result from its use. No license is granted by implication or otherwise under any patent or patent rights of Intersil or its subsidiaries.

For information regarding Intersil Corporation and its products, see www.intersil.com

Package Outline Drawing

L12.3x3A

12 LEAD THIN QUAD FLAT NO LEAD PLASTIC PACKAGE

Rev 0, 09/07

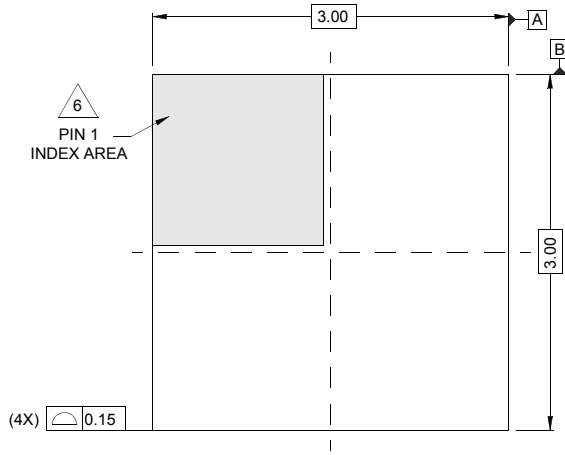

TOP VIEW

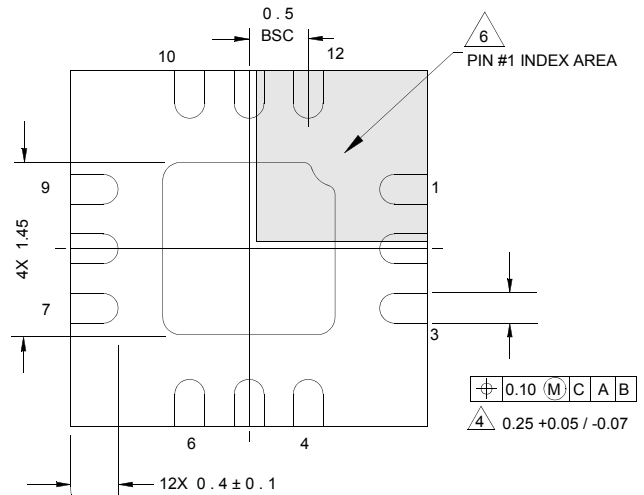

BOTTOM VIEW

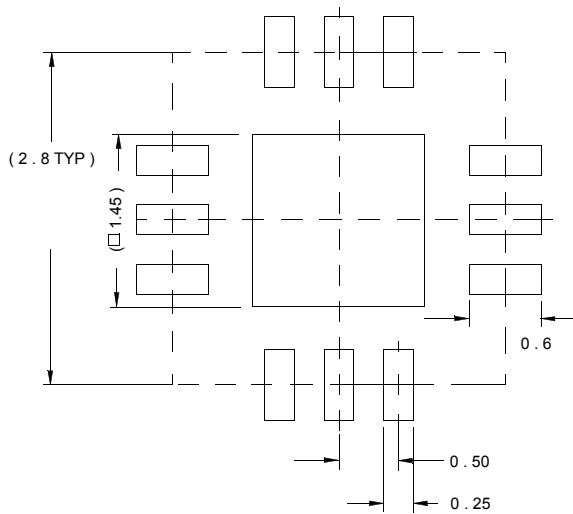

TYPICAL RECOMMENDED LAND PATTERN

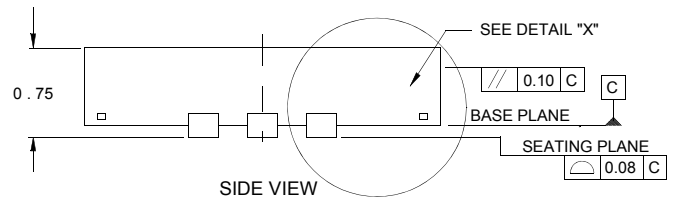

SIDE VIEW

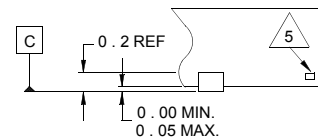

DETAIL "X"

NOTES:

1. Dimensions are in millimeters.
Dimensions in () for Reference Only.
2. Dimensioning and tolerancing conform to AMSE Y14.5m-1994.
3. Unless otherwise specified, tolerance : Decimal ± 0.05
4. Dimension b applies to the metallized terminal and is measured between 0.18mm and 0.30mm from the terminal tip.
5. Tiebar shown (if present) is a non-functional feature.
6. The configuration of the pin #1 identifier is optional, but must be located within the zone indicated. The pin #1 identifier may be either a mold or mark feature.



Компания «ЭлектроПласт» предлагает заключение долгосрочных отношений при поставках импортных электронных компонентов на взаимовыгодных условиях!

Наши преимущества:

- Оперативные поставки широкого спектра электронных компонентов отечественного и импортного производства напрямую от производителей и с крупнейших мировых складов;
- Поставка более 17-ти миллионов наименований электронных компонентов;
- Поставка сложных, дефицитных, либо снятых с производства позиций;
- Оперативные сроки поставки под заказ (от 5 рабочих дней);
- Экспресс доставка в любую точку России;
- Техническая поддержка проекта, помощь в подборе аналогов, поставка прототипов;
- Система менеджмента качества сертифицирована по Международному стандарту ISO 9001;
- Лицензия ФСБ на осуществление работ с использованием сведений, составляющих государственную тайну;
- Поставка специализированных компонентов (Xilinx, Altera, Analog Devices, Intersil, Interpoint, Microsemi, Aeroflex, Peregrine, Syfer, Eurofarad, Texas Instrument, Miteq, Cobham, E2V, MA-COM, Hittite, Mini-Circuits, General Dynamics и др.);

Помимо этого, одним из направлений компании «ЭлектроПласт» является направление «Источники питания». Мы предлагаем Вам помощь Конструкторского отдела:

- Подбор оптимального решения, техническое обоснование при выборе компонента;
- Подбор аналогов;
- Консультации по применению компонента;
- Поставка образцов и прототипов;
- Техническая поддержка проекта;
- Защита от снятия компонента с производства.



Как с нами связаться

Телефон: 8 (812) 309 58 32 (многоканальный)

Факс: 8 (812) 320-02-42

Электронная почта: org@eplast1.ru

Адрес: 198099, г. Санкт-Петербург, ул. Калинина, дом 2, корпус 4, литера А.