

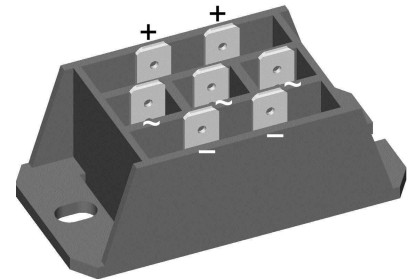
Standard Rectifier Module

3~ Rectifier	
$V_{RRM} =$	800 V
$I_{DAV} =$	60 A
$I_{FSM} =$	500 A

3~ Rectifier Bridge

Part number

VUO50-08NO3



 E72873



Features / Advantages:

- Package with DCB ceramic
- Improved temperature and power cycling
- Planar passivated chips
- Very low forward voltage drop
- Very low leakage current

Applications:

- Diode for main rectification
- For three phase bridge configurations
- Supplies for DC power equipment
- Input rectifiers for PWM inverter
- Battery DC power supplies
- Field supply for DC motors

Package: FO-F

- Isolation Voltage: 3600 V~
- Industry standard outline
- RoHS compliant
- ¼" fast-on terminals
- Easy to mount with two screws
- Base plate: DCB ceramic
- Reduced weight
- Advanced power cycling

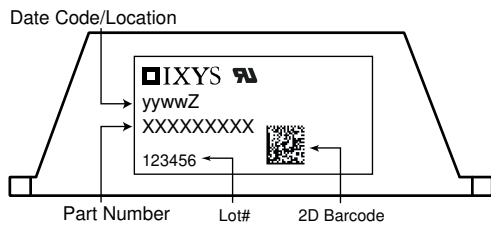
Disclaimer Notice

Information furnished is believed to be accurate and reliable. However, users should independently evaluate the suitability of and test each product selected for their own applications. Littelfuse products are not designed for, and may not be used in, all applications. Read complete Disclaimer Notice at www.littelfuse.com/disclaimer-electronics.

Rectifier				Ratings			
Symbol	Definition	Conditions		min.	typ.	max.	Unit
V_{RSM}	max. non-repetitive reverse blocking voltage					900	V
V_{RRM}	max. repetitive reverse blocking voltage					800	V
I_R	reverse current	$V_R = 800\text{ V}$	$T_{VJ} = 25^\circ\text{C}$			40	μA
		$V_R = 800\text{ V}$	$T_{VJ} = 150^\circ\text{C}$			1.5	mA
V_F	forward voltage drop	$I_F = 20\text{ A}$	$T_{VJ} = 25^\circ\text{C}$			1.07	V
		$I_F = 60\text{ A}$				1.32	V
		$I_F = 20\text{ A}$	$T_{VJ} = 125^\circ\text{C}$			0.98	V
		$I_F = 60\text{ A}$				1.30	V
I_{DAV}	bridge output current	$T_C = 110^\circ\text{C}$ rectangular	$T_{VJ} = 150^\circ\text{C}$			60	A
V_{FO}	threshold voltage	} for power loss calculation only				0.78	V
r_F	slope resistance					8.5	m Ω
R_{thJC}	thermal resistance junction to case					1.5	K/W
R_{thCH}	thermal resistance case to heatsink				0.4		K/W
P_{tot}	total power dissipation			$T_C = 25^\circ\text{C}$		80	W
I_{FSM}	max. forward surge current	$t = 10\text{ ms}; (50\text{ Hz}), \text{ sine}$	$T_{VJ} = 45^\circ\text{C}$			500	A
		$t = 8,3\text{ ms}; (60\text{ Hz}), \text{ sine}$	$V_R = 0\text{ V}$			540	A
		$t = 10\text{ ms}; (50\text{ Hz}), \text{ sine}$	$T_{VJ} = 150^\circ\text{C}$			425	A
		$t = 8,3\text{ ms}; (60\text{ Hz}), \text{ sine}$	$V_R = 0\text{ V}$			460	A
I^2t	value for fusing	$t = 10\text{ ms}; (50\text{ Hz}), \text{ sine}$	$T_{VJ} = 45^\circ\text{C}$			1.25	kA ² s
		$t = 8,3\text{ ms}; (60\text{ Hz}), \text{ sine}$	$V_R = 0\text{ V}$			1.22	kA ² s
		$t = 10\text{ ms}; (50\text{ Hz}), \text{ sine}$	$T_{VJ} = 150^\circ\text{C}$			905	A ² s
		$t = 8,3\text{ ms}; (60\text{ Hz}), \text{ sine}$	$V_R = 0\text{ V}$			880	A ² s
C_J	junction capacitance	$V_R = 400\text{ V}; f = 1\text{ MHz}$	$T_{VJ} = 25^\circ\text{C}$		25		pF



Package FO-F		Ratings				
Symbol	Definition	Conditions	min.	typ.	max.	Unit
I_{RMS}	RMS current	per terminal			100	A
T_{VJ}	virtual junction temperature		-40		150	°C
T_{op}	operation temperature		-40		125	°C
T_{stg}	storage temperature		-40		125	°C
Weight				45		g
M_D	mounting torque		2		2.5	Nm
$d_{Spp/App}$	creepage distance on surface / striking distance through air	terminal to terminal	18.0	6.0		mm
$d_{Spb/Apb}$		terminal to backside	26.0	20.0		mm
V_{ISOL}	isolation voltage	t = 1 second 50/60 Hz, RMS; $I_{ISOL} \leq 1$ mA	3600			V
			3000			V



Ordering	Ordering Number	Marking on Product	Delivery Mode	Quantity	Code No.
Standard	VUO50-08NO3	VUO50-08NO3	Box	10	417238

Equivalent Circuits for Simulation

* on die level

$T_{VJ} = 150^{\circ}C$

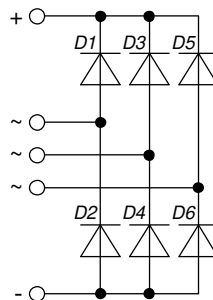
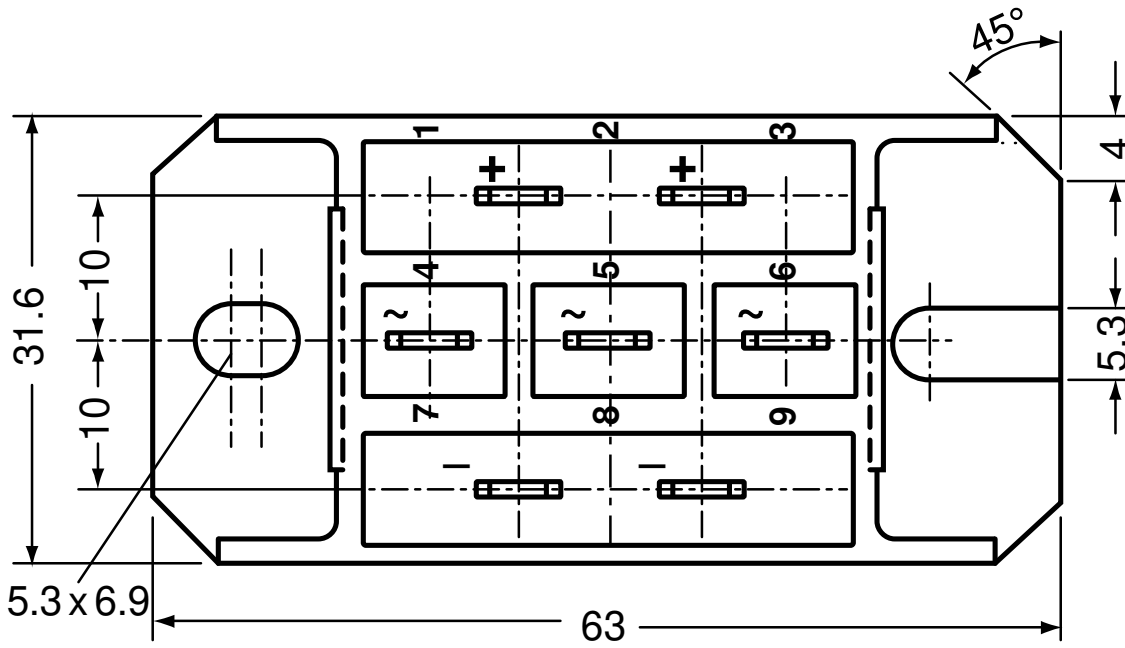
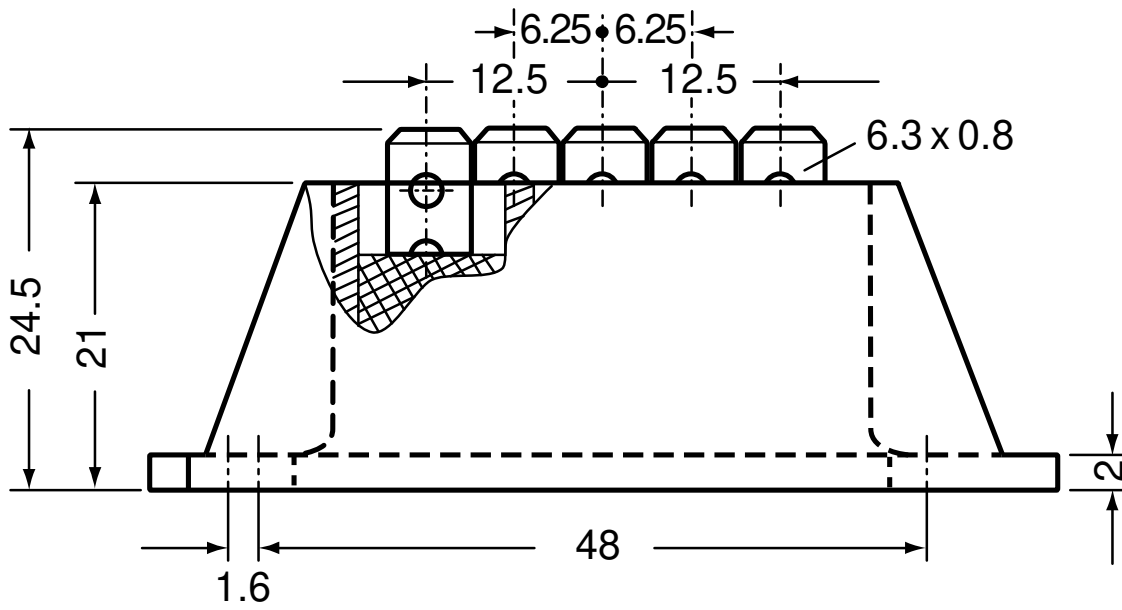


Rectifier

$V_{0\ max}$	threshold voltage	0.78	V
$R_{0\ max}$	slope resistance *	7.3	mΩ



Outlines FO-F



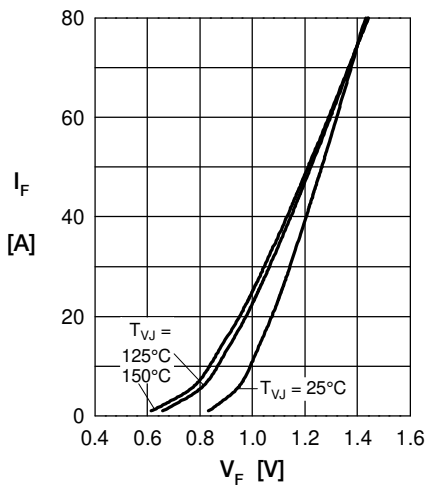
Rectifier


Fig. 1 Forward current vs. voltage drop per diode

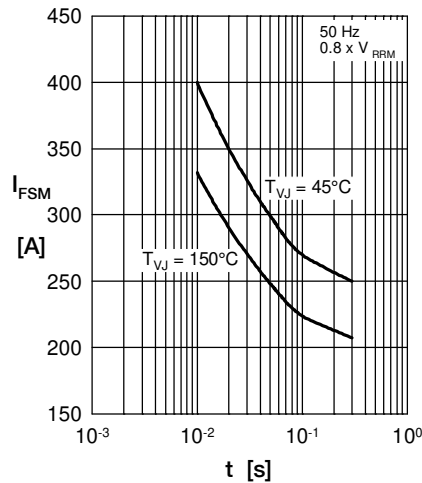


Fig. 2 Surge overload current vs. time per diode

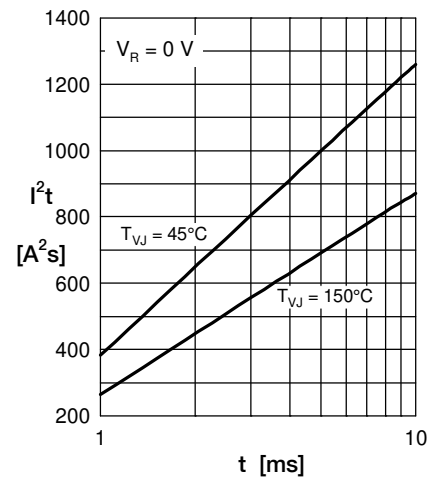
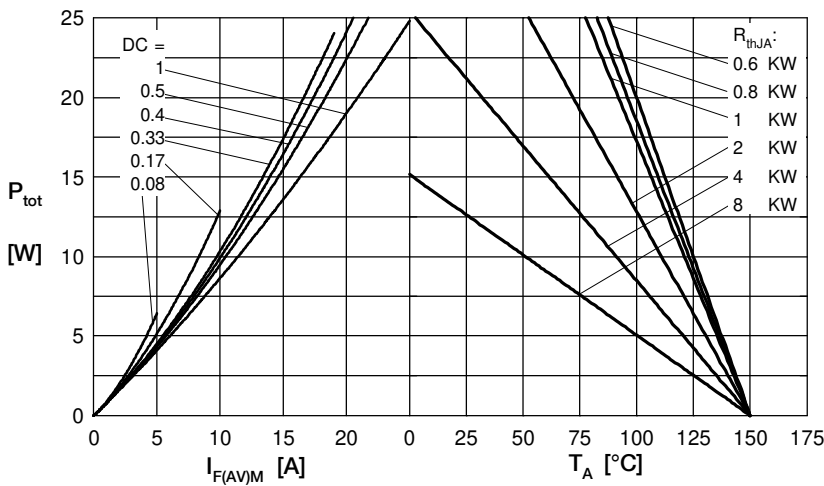

 Fig. 3 I^2t vs. time per diode


Fig. 4 Power dissipation vs. forward current and ambient temperature per diode

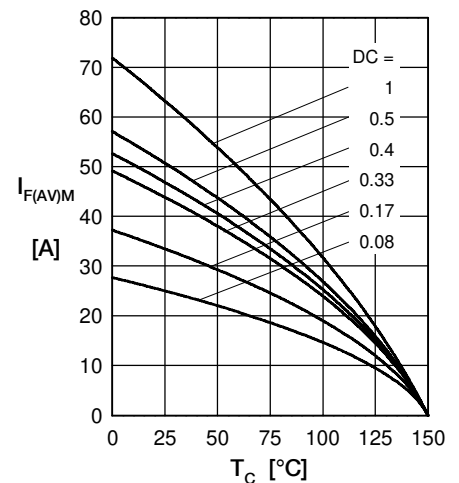


Fig. 5 Max. forward current vs. case temperature per diode

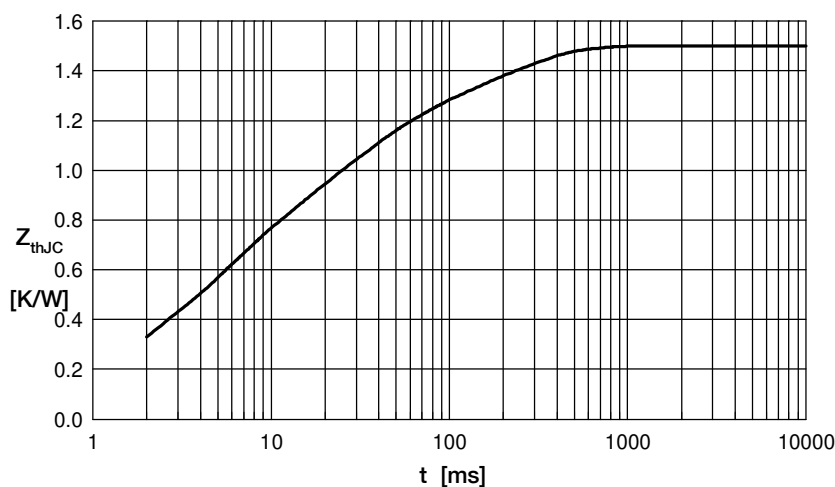


Fig. 6 Transient thermal impedance junction to case vs. time per diode

 Constants for Z_{thJC} calculation:

i	R_{th} (K/W)	t_i (s)
1	0.0607	0.00040
2	0.1330	0.00256
3	0.4305	0.00450
4	0.5130	0.02420
5	0.3628	0.18000



Компания «ЭлектроПласт» предлагает заключение долгосрочных отношений при поставках импортных электронных компонентов на взаимовыгодных условиях!

Наши преимущества:

- Оперативные поставки широкого спектра электронных компонентов отечественного и импортного производства напрямую от производителей и с крупнейших мировых складов;
- Поставка более 17-ти миллионов наименований электронных компонентов;
- Поставка сложных, дефицитных, либо снятых с производства позиций;
- Оперативные сроки поставки под заказ (от 5 рабочих дней);
- Экспресс доставка в любую точку России;
- Техническая поддержка проекта, помощь в подборе аналогов, поставка прототипов;
- Система менеджмента качества сертифицирована по Международному стандарту ISO 9001;
- Лицензия ФСБ на осуществление работ с использованием сведений, составляющих государственную тайну;
- Поставка специализированных компонентов (Xilinx, Altera, Analog Devices, Intersil, Interpoint, Microsemi, Aeroflex, Peregrine, Syfer, Eurofarad, Texas Instrument, Miteq, Cobham, E2V, MA-COM, Hittite, Mini-Circuits, General Dynamics и др.);

Помимо этого, одним из направлений компании «ЭлектроПласт» является направление «Источники питания». Мы предлагаем Вам помощь Конструкторского отдела:

- Подбор оптимального решения, техническое обоснование при выборе компонента;
- Подбор аналогов;
- Консультации по применению компонента;
- Поставка образцов и прототипов;
- Техническая поддержка проекта;
- Защита от снятия компонента с производства.



Как с нами связаться

Телефон: 8 (812) 309 58 32 (многоканальный)

Факс: 8 (812) 320-02-42

Электронная почта: org@eplast1.ru

Адрес: 198099, г. Санкт-Петербург, ул. Калинина, дом 2, корпус 4, литера А.