

D-Sub High Density Connectors D-Sub High Density Steckverbinder

D-Sub High Density connectors, 15 up to 78 pin for the type series standard and crimp, accessories and tools

D-Sub High Density Steckverbinder, 15 bis 78-polig für die Baureihen Standard und Crimp, Zubehör und Werkzeuge





All Products are RoHS compliant. A summary of all products and possible exceptions can be found on our internet site www.fctgroup.com, menu item RoHS product summary.

Alle Erzeugnisse sind RoHS konform. Eine Übersicht über alle Erzeugnisse und eventuelle Ausnahmen finden Sie auf unserer Internetseite www.fctgroup.com, Menüpunkt RoHS Artikelübersicht

Please Note

We accept no responsibility for the rights of third parties with regards to any of the herein printed tables or descriptions. With this catalogue components are illustrated, features are not guaranteed. Availability and technical alterations are subject to change without prior warning. We accept no responsibility for human error or misprints within this catalogue. We offer no guarantee for the completeness of any herein printed reports. Reproduction of this catalogue and utilization of its contents are prohibited, unless otherwise expressly stated!

January 2009

© FCT electronic gmbh, Munich, Germany

Anmerkung

Für die angegebenen Beschreibungen und Tabellen wird keine Gewähr bezüglich der Freiheit und Rechten Dritter übernommen. Mit den Angaben werden die Bauelemente spezifiziert, nicht Eigenschaften zugesichert. Liefermöglichkeiten und technische Änderungen ohne Vorankündigung, Irrtum und Druckfehler vorbehalten. Für die Abhandlungen kann keine Garantie auf Vollständigkeit übernommen werden. Vervielfältigung dieser Unterlage sowie Verwertung ihres Inhalts sind unzulässig, soweit nicht ausdrücklich zugestanden!

Januar 2009

© FCT electronic gmbh, München, Deutschland

List of Contents

Inhaltsverzeichnis

General Information	6
<i>Allgemeine Informationen</i>	6
High Density D-Sub Connectors	6
<i>High Density D-Sub Steckverbinder</i>	6
Technical Data	6
<i>Technische Daten</i>	6
Ordering Code (High Density D-Sub Connectors)	7
<i>Bestellschlüssel (High Density D-Sub Steckverbinder)</i>	7
Pin: Solder Pot Termination.....	8
<i>Stift: Löttopfanschluss</i>	8
Socket: Solder Pot Termination.....	9
<i>Buchse: Löttopfanschluss</i>	9
Pin: Straight PCB Termination.....	10
<i>Stift: Gerader Leiterplattenanschluss</i>	10
Socket: Straight PCB Termination.....	11
<i>Buchse: Gerader Leiterplattenanschluss</i>	11
Pin: Right Angled PCB Termination.....	12
<i>Stift: Abgewinkelter Leiterplattenanschluss</i>	12
Socket: Right Angled PCB Termination.....	13
<i>Buchse: Abgewinkelter Leiterplattenanschluss</i>	13
Panel Cut-out.....	14
<i>Montageausschnitt</i>	14
High Density D-Sub Crimp Connectors	15
<i>High Density D-Sub Crimp Steckverbinder</i>	15
Technical Data	15
<i>Technische Daten</i>	15
Ordering Code (High Density D-Sub Crimp Connectors)	16
<i>Bestellschlüssel (High Density D-Sub Crimp Steckverbinder)</i>	16
Pin: Crimp Termination	17
<i>Stift: Crimpanschluss</i>	17
Socket: Crimp Termination	18
<i>Buchse: Crimpanschluss</i>	18
Stamped Crimp Contacts	19
<i>Gestanzte Crimpkontakte</i>	19
Turned Crimp Contacts	20
<i>Gedrehte Crimpkontakte</i>	20
Accessories	21
<i>Zubehör</i>	21
Clinch Nuts.....	21
<i>Einnietmuttern</i>	21
Threaded Spacers	21
<i>Abstandsbolzen</i>	21
Frontside Spacers and Rearside Spacers or Snap-in Bolts	22
<i>Frontseitiger Abstandsbolzen und rückseitiger Abstands- oder Schnappbolzen</i>	22
Snap-in Bolts for PCB Mounting.....	23
<i>Schnappbolzen für Leiterplattenmontage</i>	23
Female Screw Locks F-GSCH1/5.....	23
<i>Sechskantbolzen F-GSCH1/5</i>	23



List of Contents

Inhaltsverzeichnis

Shielded Right Angled Adapter, Screwable	24
<i>Geschirmter Winkeladapter, verschraubbar</i>	<i>24</i>

Ordering Code, Use Contact Type and Direction of Right Angled Contacts	24
<i>Bestellschlüssel, Nutzung Kontaktart und Richtung der abgewinkelten Kontakte</i>	<i>24</i>

Ordering Code	25
<i>Bestellschlüssel</i>	<i>25</i>

Technical Data	26
<i>Technische Daten</i>	<i>26</i>

Dimensions	27
<i>Abmessungen</i>	<i>27</i>

Application Example	27
<i>Einsatzbeispiel</i>	<i>27</i>



Crimping Tools	28
<i>Crimpwerkzeuge</i>	<i>28</i>

For Stamped Contacts	28
<i>Für gestanzte Kontakte</i>	<i>28</i>

For Turned MIL- and Standard Contacts	29
<i>Für gedrehte MIL- und Standardkontakte</i>	<i>29</i>



Insertion and Extraction Tools	29
<i>Ein- und Ausbauwerkzeuge</i>	<i>29</i>

Plastic Insertion / Extraction Tool	29
<i>Ein- / Ausbauwerkzeug aus Kunststoff</i>	<i>29</i>

Plastic Insertion / Extraction Tool with Metal Clips	29
<i>Ein- / Ausbauwerkzeug aus Kunststoff mit Metallspitzen</i>	<i>29</i>

Insertion Tool - Metal Tweezers	29
<i>Einbauwerkzeug - Metallpinzette</i>	<i>29</i>

Extraction Tool - Metal Tweezers	29
<i>Ausbauwerkzeug - Metallpinzette</i>	<i>29</i>



Waterproof Connector Systems	30
<i>Wasserdichte Steckverbindersysteme</i>	<i>30</i>

Ordering Code for Waterproof Connectors	30
<i>Bestellschlüssel für wasserdichte Steckverbinder</i>	<i>30</i>

Technical Data	31
<i>Technische Daten</i>	<i>31</i>

Waterproof Connectors with Metal Watertight Frame	32
<i>Wasserdichte Steckverbinder mit Metalldichtrahmen</i>	<i>32</i>

Ordering Data (Waterproof D-Sub Connectors for FWH Hoods)	33
<i>Bestelldaten (wasserdichte D-Sub Steckverbinder für Hauben FWH)</i>	<i>33</i>

Front Mounting	34
<i>Frontseitige Montage</i>	<i>34</i>

Rear Mounting	34
<i>Rückseitige Montage</i>	<i>34</i>

Accessories for Pin Connectors	34
<i>Zubehör für Stiftsteckverbinder</i>	<i>34</i>

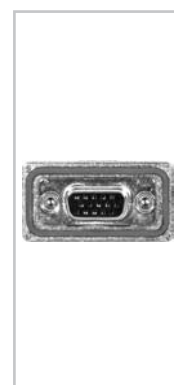

Order Number Index	35
<i>Bestellnummern - Index</i>	<i>35</i>





General Information

Allgemeine Informationen

In terms of their outside dimensions the shells of the high density D-Sub series are the same as for the well known standard D-Sub connectors, but the number of contacts has been considerably increased.

Due to the higher density of 15, 26, 44, 62 and 78 contacts, this series is ideally suited for the most modern applications in data transmission and telecommunications, as well as in measurement, regulation and control devices.

Protection against misalignment or bending of contacts is guaranteed by the use of a trapeze shaped metal shell. The tin plated shells also offer good shielding qualities and are mechanically stable. Because of their compact design and low mounting flange, these connectors can also be used without difficulty in the tried and tested 19"-modules.

These connectors are available in straight and right angled versions for p.c. boards. They can also be supplied for cable assemblies in solder or crimp version. The heat resistant plastics used in the production of the connectors meet UL94V-0 requirements.

Die High Density D-Sub Serie verwendet von den Außenabmessungen die Gehäuse der bekannten Standard D-Sub Steckverbinder, jedoch hat sich die Anzahl der Kontakte wesentlich erhöht.

Durch die höhere Dichte von 15, 26, 44, 62 und 78 Kontakten eignet sich diese Serie hervorragend für modernste Anwendungen der Datentechnik, Telekommunikation sowie Mess-, Regel- und Steuerungstechnik.

Ein sicherer Verdrehenschutz ist durch das trapezförmige Metallgehäuse gewährleistet. Die verzinneten Gehäuse bieten gute Abschirmeigenschaften und sind mechanisch stabil. Aufgrund der kompakten Bauweise und des niedrigen Montageflansches sind diese Steckverbinder in den bewährten 19"-Einschüben problemlos einsetzbar.

Die Steckverbinder sind in gerader bzw. abgewinkelter Ausführung für Leiterplattenmontage sowie zur Kabelmontage in Löt- oder Crimptechnik lieferbar. Die verwendeten temperaturbeständigen Kunststoffe entsprechen den Anforderungen nach UL94V-0.

High Density D-Sub Connectors

High Density D-Sub Steckverbinder

Technical Data

Technische Daten

Mechanical Data

Mechanische Daten

Mechanical Data <i>Mechanische Daten</i>	
Shell <i>Gehäuse</i>	Steel, tin plated; pin shell with dimples <i>Stahl, verzinkt; Stiftgehäuse mit Kontaktnoppen</i>
Insulator <i>Isolierkörper</i>	Thermoplastic, glassfilled UL94V-0 <i>Thermoplast, glasfaserverstärkt UL94V-0</i>
Signal contacts <i>Signalkontakte</i>	Copper alloy, flash gold plated <i>Kupferlegierung, Oberfläche Hauchvergoldung</i>

Electrical Data

Elektrische Daten

Electrical Data <i>Elektrische Daten</i>	
Current rating <i>Maximale Stromstärke</i>	3 A
Contact resistance <i>Durchgangswiderstand</i>	≤ 15 mΩ
Insulation resistance <i>Isolationswiderstand</i>	≥ 3000 MΩ
Test voltage <i>Prüfspannung</i>	1000 V
Operating temperature <i>Betriebstemperatur</i>	-55 °C bis 105 °C (-67 °F to 221 °F)



Ordering Code (High Density D-Sub Connectors)

Bestellschlüssel (High Density D-Sub Steckverbinder)

CT W 09-15 S 5 - ...

High Density D-Sub series prefix
High Density D-Sub Serienbezeichnung

Mounting Type / Befestigungsarten

- Standard / *Standard*
- W** Float mounted / *Schwimmend* *
- T** Clinch nut 4-40 UNC / *Einnietmutter 4-40 UNC* *
- Z** Clinch nut M3 / *Einnietmutter M3* *
- TS** Clinch nut 4-40 UNC, self locking / *Einnietmutter 4-40 UNC, selbstsichernd* *
- ZS** Clinch nut M3, self locking / *Einnietmutter M3, selbstsichernd* *

* Not with contact design 5 / *nicht mit Kontaktvariante 5*

No. of Contacts / Polzahlen

- 09-15** 15 contacts in shell size 1 (corresponds to 9 pin D-Sub standard connector shell)
15-polig in Gehäusegröße 1 (entspricht 9poligem D-Sub Standard Steckverbindergehäuse)
- 15-26** 26 contacts in shell size 2 (corresponds to 15 pin D-Sub standard connector shell)
26-polig in Gehäusegröße 2 (entspricht 15poligem D-Sub Standard Steckverbindergehäuse)
- 25-44** 44 contacts in shell size 3 (corresponds to 25 pin D-Sub standard connector shell)
44-polig in Gehäusegröße 3 (entspricht 25poligem D-Sub Standard Steckverbindergehäuse)
- 37-62** 62 contacts in shell size 4 (corresponds to 37 pin D-Sub standard connector shell)
62-polig in Gehäusegröße 4 (entspricht 37poligem D-Sub Standard Steckverbindergehäuse)
- 50-78** 78 contacts in shell size 5 (corresponds to 50 pin D-Sub standard connector shell)
78-polig in Gehäusegröße 5 (entspricht 50poligem D-Sub Standard Steckverbindergehäuse)

Contact Type / Kontaktart

- P** Pin / *Stift*
- S** Socket / *Buchse*

Contact Design / Kontaktvariante

- Solder pot termination / *Löttopfanschluss*
- 1** Straight PCB termination / *Gerader Leiterplattenanschluss*
- 5** Right angled PCB termination / *Abgewinkelter Leiterplattenanschluss*

Modifications / Modifikationen

For contact design 5 only! / *Nur für Kontaktvariante 5!*

- L228** See pages 12 and 13 (supplied with 4-40 UNC-2B clinch nut, plastic bracket and grounding bracket with snap-in)
Siehe Seiten 12 und 13 (mit Gewindeniet 4-40 UNC-2B, Kunststoffwinkel und Snap-In Massewinkel)
- L229** See pages 12 and 13 (with M3 clinch nut, plastic bracket and grounding bracket with snap-in)
Siehe Seiten 12 und 13 (mit Gewindeniet M3, Kunststoffwinkel und Snap-In Massewinkel)
- L222** See pages 12 and 13 (with 4-40 UNC-2B clinch nut, plastic bracket and grounding bracket with through hole)
Siehe Seiten 12 und 13 (mit Gewindeniet 4-40 UNC-2B, Kunststoffwinkel und Massewinkel mit Durchgangsloch)

Further modifications are listed in our D-Sub miniature connector catalogue.
Weitere Modifikationen sind in unserem D-Sub Miniatur Steckverbinder Katalog aufgeführt.



Pin: Solder Pot Termination

Stift: Löttopfanschluss

Dimensions

Abmessungen



Stamped contacts
(wire size:
max. AWG 22)
Gestanzte Kontakte
(Drahtgröße:
max. AWG 22)

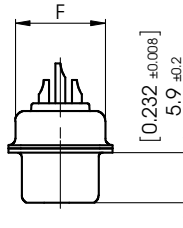

Pin Connector, Front View

Stiftsteckverbinder, Frontansicht

15 contacts
15 Kontakte

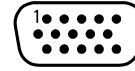

26 contacts
26 Kontakte

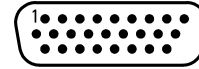

44 contacts
44 Kontakte

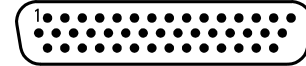

62 contacts
62 Kontakte

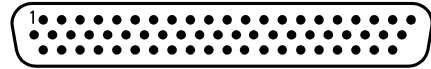

78 contacts
78 Kontakte

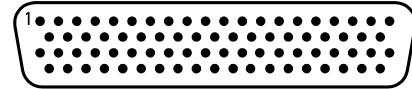

Dimensions

Abmessungen

Order Number <i>Bestellnummer</i>	Shell Size <i>Gehäusegröße</i>	Number of Contacts <i>Polzahl</i>	A ±0,4 (±0.016)	B +0,2 (+0.008)	C ±0,15 (±0.006)	D +0,2 (+0.008)	E ±0,4 (±0.016)	F ±0,3 (±0.012)	G ±0,3 (±0.012)
CT09-15P	1	15	30,8 (1.213)	16,9 (0.665)	25,0 (0.984)	8,2 (0.323)	12,5 (0.492)	10,8 (0.425)	19,3 (0.760)
CT15-26P	2	26	39,1 (1.539)	25,2 (0.992)	33,3 (1.311)	8,2 (0.323)	12,5 (0.492)	10,8 (0.425)	27,5 (1.083)
CT25-44P	3	44	53,0 (2.087)	38,9 (1.531)	47,04 (1.852)	8,2 (0.323)	12,5 (0.492)	10,8 (0.425)	41,3 (1.626)
CT37-62P	4	62	69,3 (2.728)	55,3 (2.177)	63,5 (2.500)	8,2 (0.323)	12,5 (0.492)	10,8 (0.425)	57,7 (2.272)
CT50-78P	5	78	66,9 (2.634)	52,8 (2.079)	61,1 (2.406)	11,0 (0.433)	15,4 (0.606)	13,7 (0.539)	55,3 (2.177)



Socket: Solder Pot Termination

Buchse: Löttopfanschluss

Dimensions

Abmessungen



Stamped contacts
(wire size:
max. AWG 22)
Gestanzte Kontakte
(Drahtgröße:
max. AWG 22)

Socket Connector, Front View

Buchsensteckverbinder, Frontansicht

15 contacts
15 Kontakte

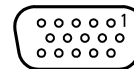

26 contacts
26 Kontakte

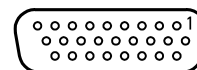

44 contacts
44 Kontakte

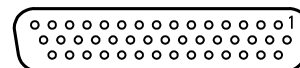

62 contacts
62 Kontakte

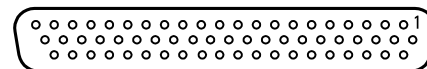

78 contacts
78 Kontakte

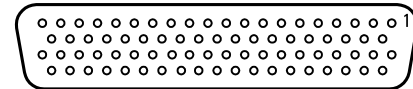

Dimensions

Abmessungen

Order Number <i>Bestellnummer</i>	Shell Size <i>Gehäusegröße</i>	Number of Contacts <i>Polzahl</i>	A ±0,4 (±0.016)	B -0,2 (-0.008)	C ±0,15 (±0.006)	D -0,2 (-0.008)	E ±0,4 (±0.016)	F ±0,3 (±0.012)	G ±0,3 (±0.012)
CT09-15S	1	15	30,8 (1.213)	16,4 (0.646)	25,0 (0.984)	8,0 (0.315)	12,5 (0.492)	10,8 (0.425)	19,3 (0.760)
CT15-26S	2	26	39,1 (1.539)	24,7 (0.972)	33,3 (1.311)	8,0 (0.315)	12,5 (0.492)	10,8 (0.425)	27,5 (1.083)
CT25-44S	3	44	53,0 (2.087)	38,5 (1.516)	47,04 (1.852)	8,0 (0.315)	12,5 (0.492)	10,8 (0.425)	41,3 (1.626)
CT37-62S	4	62	69,3 (2.728)	54,9 (2.161)	63,5 (2.500)	8,0 (0.315)	12,5 (0.492)	10,8 (0.425)	57,7 (2.272)
CT50-78S	5	78	66,9 (2.634)	52,5 (2.067)	61,1 (2.406)	10,8 (0.425)	15,4 (0.606)	13,7 (0.539)	55,3 (2.177)



Pin: Straight PCB Termination

Stift: Gerader Leiterplattenanschluss

Dimensions

Abmessungen

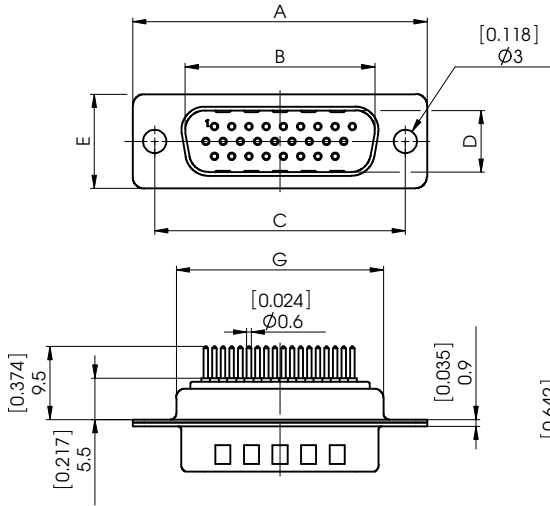

Stamped contacts
Gestanzte Kontakte

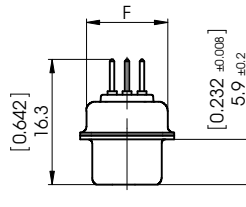

Pin Connector, Front View

Stiftsteckverbinder, Frontansicht

15 contacts
15 Kontakte



26 contacts
26 Kontakte

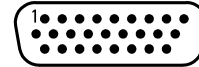

44 contacts
44 Kontakte

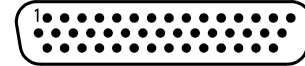

62 contacts
62 Kontakte

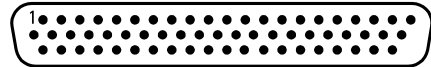

78 contacts
78 Kontakte



PCB Hole Pattern (Mounting Side)

Leiterplattenlochbild (Bestückungsseite)

Hole Pattern 15 Contacts

Lochbild 15-polig

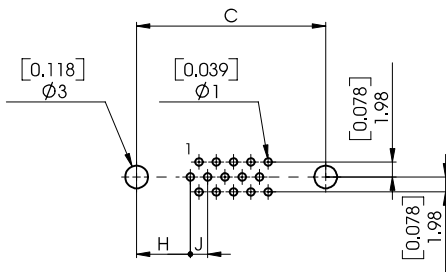

Hole Pattern 26, 44 and 62 Contacts

Lochbild 26-, 44- und 62-polig

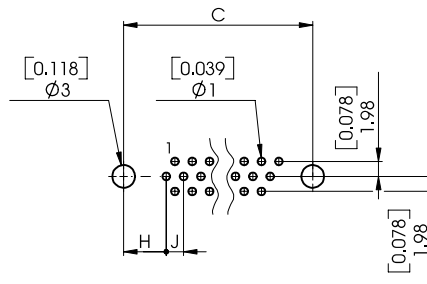

Hole Pattern 78 Contacts

Lochbild 78-polig

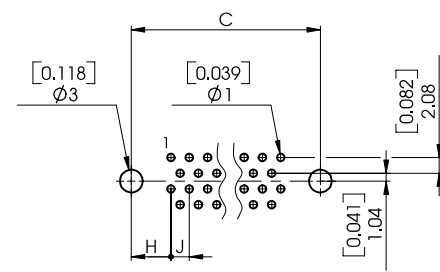

Dimensions

Abmessungen

Order Number <i>Bestellnummer</i>	Shell Size <i>Gehäusegröße</i>	Number of Contacts <i>Polzahl</i>	A ±0,4 (±0.016)	B +0,2 (+0.008)	C ±0,15 (±0.006)	D +0,2 (+0.008)	E ±0,4 (±0.016)	F ±0,3 (±0.012)	G ±0,3 (±0.012)	H	J
CT09-15P1	1	15	30,8 (1.213)	16,9 (0.665)	25,0 (0.984)	8,2 (0.323)	12,5 (0.492)	10,8 (0.425)	19,3 (0.760)	7,10 (0.280)	2,29 (0.090)
CT15-26P1	2	26	39,1 (1.539)	25,2 (0.992)	33,3 (1.311)	8,2 (0.323)	12,5 (0.492)	10,8 (0.425)	27,5 (1.083)	6,80 (0.268)	2,29 (0.090)
CT25-44P1	3	44	53,0 (2.087)	38,9 (1.531)	47,04 (1.852)	8,2 (0.323)	12,5 (0.492)	10,8 (0.425)	41,3 (1.626)	7,00 (0.276)	2,29 (0.090)
CT37-62P1	4	62	69,3 (2.728)	55,3 (2.177)	63,5 (2.500)	8,2 (0.323)	12,5 (0.492)	10,8 (0.425)	57,7 (2.272)	7,00 (0.276)	2,42 (0.095)
CT50-78P1	5	78	66,9 (2.634)	52,8 (2.079)	61,1 (2.406)	11,0 (0.433)	15,4 (0.606)	13,7 (0.539)	55,3 (2.177)	7,60 (0.299)	2,42 (0.095)



Socket: Straight PCB Termination

Buchse: Gerader Leiterplattenanschluss

Dimensions

Abmessungen



Stamped contacts
Gestanzte Kontakte

Socket Connector, Front View

Buchsensteckverbinder, Frontansicht

15 contacts
15 Kontakte



26 contacts
26 Kontakte

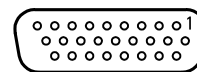

44 contacts
44 Kontakte

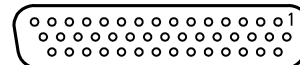

62 contacts
62 Kontakte



78 contacts
78 Kontakte

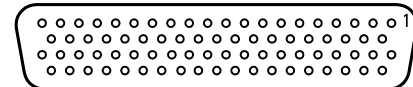

PCB Hole Pattern (Mounting Side)

Leiterplattenlochbild (Bestückungsseite)

Hole Pattern 15 Contacts

Lochbild 15-polig



Hole Pattern 26, 44 and 62 Contacts

Lochbild 26-, 44- und 62-polig



Hole Pattern 78 Contacts

Lochbild 78-polig

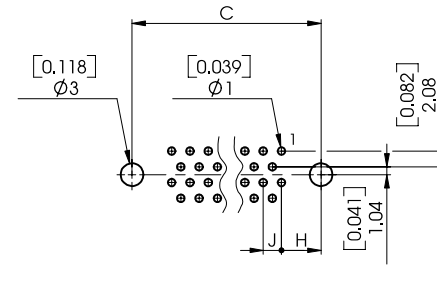

Dimensions

Abmessungen

Order Number Bestellnummer	Shell Size Gehäusegröße	Number of Contacts Polzahl	A	B	C	D	E	F	G	H	J
			$\pm 0,4$ (± 0.016)	$-0,2$ (-0.008)	$\pm 0,15$ (± 0.006)	$-0,2$ (-0.008)	$\pm 0,4$ (± 0.016)	$\pm 0,3$ (± 0.012)	$\pm 0,3$ (± 0.012)		
CT09-15S1	1	15	30,8 (1.213)	16,4 (0.646)	25,0 (0.984)	8,0 (0.315)	12,5 (0.492)	10,8 (0.425)	19,3 (0.760)	7,10 (0.280)	2,29 (0.090)
CT15-26S1	2	26	39,1 (1.539)	24,7 (0.972)	33,3 (1.311)	8,0 (0.315)	12,5 (0.492)	10,8 (0.425)	27,5 (1.083)	6,80 (0.268)	2,29 (0.090)
CT25-44S1	3	44	53,0 (2.087)	38,5 (1.516)	47,04 (1.852)	8,0 (0.315)	12,5 (0.492)	10,8 (0.425)	41,3 (1.626)	7,00 (0.276)	2,29 (0.090)
CT37-62S1	4	62	69,3 (2.728)	54,9 (2.161)	63,5 (2.500)	8,0 (0.315)	12,5 (0.492)	10,8 (0.425)	57,7 (2.272)	7,00 (0.276)	2,42 (0.095)
CT50-78S1	5	78	66,9 (2.634)	52,5 (2.067)	61,1 (2.406)	10,8 (0.425)	15,4 (0.606)	13,7 (0.539)	55,3 (2.177)	7,60 (0.299)	2,42 (0.095)



Pin: Right Angled PCB Termination

Stift: Abgewinkelter Leiterplattenanschluss

Dimensions

Abmessungen



4-40 UNC-2B or M3 clinch nut on connector flange available.
Mit 4-40 UNC-2B bzw. M3 Gewinde-niet im Steckerflansch lieferbar.

Stamped contacts Gestanzte Kontakte



For snap-in or through hole
Für Snap-in oder Durchgangsloch

Pin Connector, Front View

Stiftsteckverbinder, Frontansicht

15 contacts
15 Kontakte



26 contacts
26 Kontakte

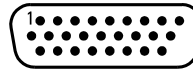

44 contacts
44 Kontakte



62 contacts
62 Kontakte



PCB Hole Pattern (Mounting Side)

Leiterplattenlochbild (Bestückungsseite)

Hole Pattern 15 Contacts

Lochbild 15-polig

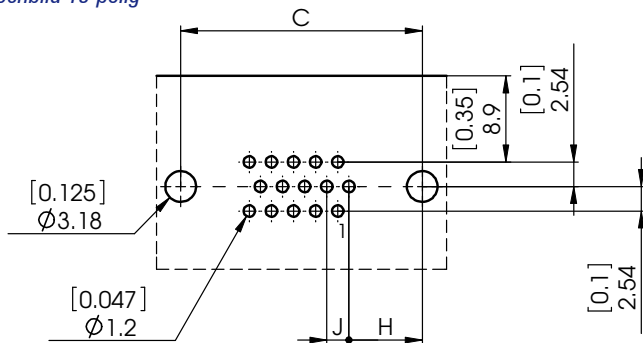

Hole Pattern 26, 44 and 62 Contacts

Lochbild 26-, 44- und 62-polig

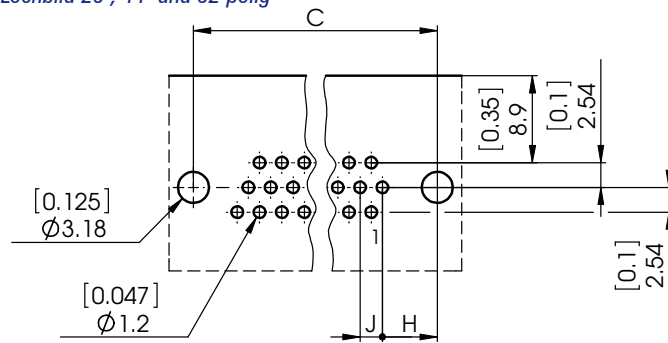

Dimensions

Abmessungen

Order Number Bestellnummer		Shell Size Gehäusegröße	Number of Contacts Polzahl	A	B	C	H	J	
Grounding Brackets with Snap-in Snap-in Massewinkel 4-40 UNC-2B	M3	Grounding Brackets without Snap-in Massewinkel ohne Snap-in 4-40 UNC-2B		±0,4 (±0.016)	+0,2 (+0.008)	±0,15 (±0.006)			
CT09-15P5-L228	CT09-15P5-L229	CT09-15P5-L222	1	15	30,8 (1.213)	16,9 (0.665)	25,0 (0.984)	7,10 (0.280)	2,29 (0.090)
CT15-26P5-L228	CT15-26P5-L229	CT15-26P5-L222	2	26	39,1 (1.539)	25,2 (0.992)	33,3 (1.311)	6,80 (0.268)	2,29 (0.090)
CT25-44P5-L228	CT25-44P5-L229	CT25-44P5-L222	3	44	53,0 (2.087)	38,9 (1.531)	47,04 (1.852)	7,00 (0.276)	2,29 (0.090)
CT37-62P5-L228	CT37-62P5-L229	CT37-62P5-L222	4	62	69,3 (2.728)	55,3 (2.177)	63,5 (2.500)	7,00 (0.276)	2,42 (0.095)



Socket: Right Angled PCB Termination

Buchse: Abgewinkelter Leiterplattenanschluss

Dimensions

Abmessungen

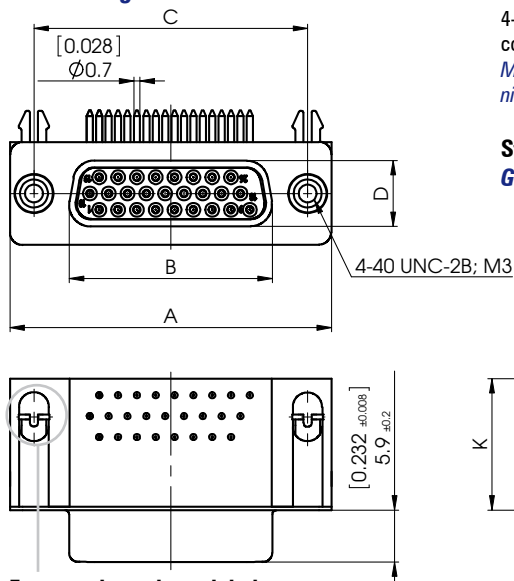

For snap-in or through hole
Für Snap-in oder Durchgangsloch

4-40 UNC-2B or M3 clinch nut on connector flange available.
Mit 4-40 UNC-2B bzw. M3 Gewinde-nut im Steckerflansch lieferbar.

Stamped contacts Gestanzte Kontakte

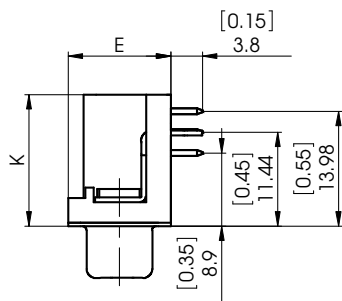

Socket Connector, Front View

Buchsensteckverbinder, Frontansicht

15 contacts
15 Kontakte

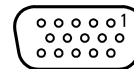

26 contacts
26 Kontakte

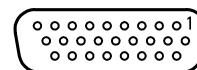

44 contacts
44 Kontakte

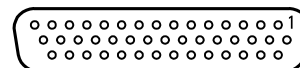

62 contacts
62 Kontakte

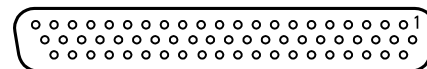

78 contacts
78 Kontakte

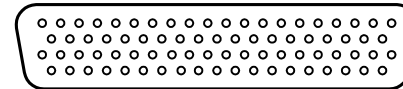

PCB Hole Pattern (Mounting Side)

Leiterplattenlochbild (Bestückungsseite)

Hole Pattern 15 Contacts

Lochbild 15-polig

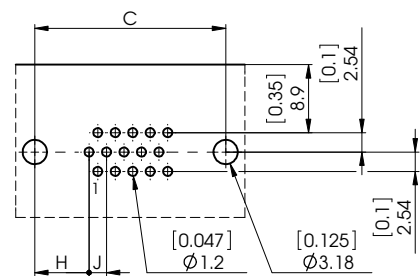

Hole Pattern 26, 44 and 62 Contacts

Lochbild 26-, 44- und 62-polig

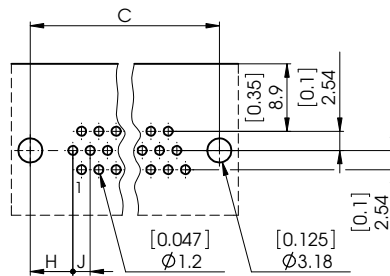

Hole Pattern 78 Contacts

Lochbild 78-polig

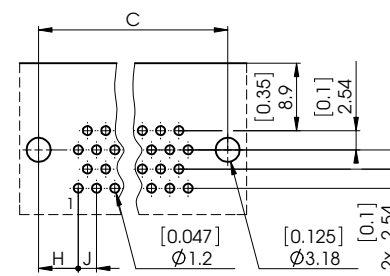

Dimensions

Abmessungen

Order Number Bestellnummer		Shell Size Gehäusegröße	Number of Contacts Polzahl	A	B	C	E	H	J	K	
Grounding Brackets with Snap-in Snap-in Massewinkel		Grounding Brackets without Snap-in Massewinkel ohne Snap-in		±0,4 (±0.016)	-0,2 (-0.008)	±0,15 (±0.006)	±0,4 (±0.016)	7,10 (0.280)	2,29 (0.090)	16,0 (0.630)	
4-40 UNC-2B	M3	4-40 UNC-2B									
CT09-15S5-L228	CT09-15S5-L229	CT09-15S5-L222	1	15	30,8 (1.213)	16,4 (0.646)	25,0 (0.984)	12,5 (0.492)	7,10 (0.280)	2,29 (0.090)	16,0 (0.630)
CT15-26S5-L228	CT15-26S5-L229	CT15-26S5-L222	2	26	39,1 (1.539)	24,7 (0.972)	33,3 (1.311)	12,5 (0.492)	6,80 (0.268)	2,29 (0.090)	16,0 (0.630)
CT25-44S5-L228	CT25-44S5-L229	CT25-44S5-L222	3	44	53,0 (2.087)	38,5 (1.516)	47,04 (1.852)	12,5 (0.492)	7,00 (0.276)	2,29 (0.090)	16,0 (0.630)
CT37-62S5-L228	CT37-62S5-L229	CT37-62S5-L222	4	62	69,3 (2.728)	54,9 (2.161)	63,5 (2.500)	12,5 (0.492)	7,00 (0.276)	2,42 (0.095)	16,0 (0.630)
CT50-78S5-L228	CT50-78S5-L229*	—	5	78	66,9 (2.634)	52,5 (2.067)	61,1 (2.406)	13,8 (0.543)	7,60 (0.299)	2,42 (0.095)	17,4 (0.685)

* On request / auf Anfrage



Panel Cut-out

Montageausschnitt

Front Mounted

Frontseitig montiert

Standard, Front Mounted

Standard, frontseitig montiert



Shell Size Gehäusegröße	A	B	C
1	±0,2 (±0.008) 22,2 (0.874)	±0,1 (±0.004) 25,0 (0.984)	±0,2 (±0.008) 12,3 (0.484)
2	30,5 (1.201)	33,3 (1.311)	12,3 (0.484)
3	44,3 (1.744)	47,0 (1.850)	12,3 (0.484)
4	60,7 (2.390)	63,5 (2.500)	12,3 (0.484)
5	58,3 (2.295)	61,1 (2.406)	15,1 (0.594)

Float, Front Mounted (Series FW)

Schwimmend, frontseitig montiert (Baureihe FW)



Shell Size Gehäusegröße	Mounting Befestigung	Ø D
1 - 5	Standard / <i>Standard</i>	±0,05 (±0.002) 3,1 (0.122)
1 - 5	Float mounted / <i>schwimmend</i>	2,2 (0.087)

Rear Mounted

Rückseitig montiert

Standard, Rear Mounted

Standard, rückseitig montiert



Shell Size Gehäusegröße	A	B	C
1	±0,2 (±0.008) 20,5 (0.807)	±0,1 (±0.004) 25,0 (0.984)	±0,2 (±0.008) 11,4 (0.449)
2	28,8 (1.134)	33,3 (1.311)	11,4 (0.449)
3	42,5 (1.673)	47,0 (1.850)	11,4 (0.449)
4	59,1 (2.327)	63,5 (2.500)	11,4 (0.449)
5	56,3 (2.217)	61,1 (2.406)	14,1 (0.555)

Float, Rear Mounted (Series FW)

Schwimmend, rückseitig montiert (Baureihe FW)



Shell Size Gehäusegröße	Mounting Befestigung	Ø D
1 - 5	Standard / <i>Standard</i>	±0,05 (±0.002) 3,1 (0.122)
1 - 5	float mounted / <i>schwimmend</i>	2,2 (0.087)



The information for the panel cut-out is also valid for the crimp connectors (from page 15 onwards).
Die Angaben zu den Montageausschnitten sind auch für die Crimpsteckverbinder (ab Seite 15) gültig.



High Density D-Sub Crimp Connectors

High Density D-Sub Crimp Steckverbinder

Technical Data

Technische Daten

Mechanical Data

Mechanische Daten

Mechanical Data <i>Mechanische Daten</i>	
Shell <i>Gehäuse</i>	Steel, tin plated; pin shell with dimples <i>Stahl, verzinkt; Stiftgehäuse mit Kontaktnoppen</i>
Insulator <i>Isolierkörper</i>	Thermoplastic, glassfilled UL94V-0 <i>Thermoplast, glasfaserverstärkt UL94V-0</i>
Signal contacts <i>Signalkontakte</i>	Copper alloy, gold plated <i>Kupferlegierung, vergoldet</i>

Electrical Data

Elektrische Daten

Electrical Data <i>Elektrische Daten</i>	
Current rating <i>Maximale Stromstärke</i>	3 A
Contact resistance <i>Durchgangswiderstand</i>	$\leq 10 \text{ m}\Omega$
Insulation resistance <i>Isolationswiderstand</i>	$\geq 5000 \text{ M}\Omega$
Test voltage <i>Prüfspannung</i>	1000 V
Operating temperature <i>Betriebstemperatur</i>	-55 °C bis 115 °C (-67 °F to 239 °F)



Ordering Code (High Density D-Sub Crimp Connectors)

Bestellschlüssel (High Density D-Sub Crimp Steckverbinder)

FL W 09-15 P 7 - ...

High Density D-Sub series prefix
High Density D-Sub Serienbezeichnung

- FL** Shell size 1 - 4 / *Gehäusegröße 1 - 4*
- CT** Shell size 5 / *Gehäusegröße 5*

Mounting Type / *Befestigungsarten*

- Standard / *Standard*
- W** Float mounted / *Schwimmend*
- T** Clinch nut 4-40 UNC / *Einnietmutter 4-40 UNC*
- Z** Clinch nut M3 / *Einnietmutter M3*
- TS** Clinch nut 4-40 UNC, self locking / *Einnietmutter 4-40 UNC, selbstsichernd*
- ZS** Clinch nut M3, self locking / *Einnietmutter M3, selbstsichernd*

No. of Contacts / *Polzahlen*

- 09-15** 15 contacts in shell size 1 (corresponds to 9 pin D-Sub standard connector shell) *
*15-polig in Gehäusegröße 1 (entspricht 9poligem D-Sub Standard Steckverbindergehäuse) **
- 15-26** 26 contacts in shell size 2 (corresponds to 15 pin D-Sub standard connector shell) *
*26-polig in Gehäusegröße 2 (entspricht 15poligem D-Sub Standard Steckverbindergehäuse) **
- 25-44** 44 contacts in shell size 3 (corresponds to 25 pin D-Sub standard connector shell) *
*44-polig in Gehäusegröße 3 (entspricht 25poligem D-Sub Standard Steckverbindergehäuse) **
- 37-62** 62 contacts in shell size 4 (corresponds to 37 pin D-Sub standard connector shell) *
*62-polig in Gehäusegröße 4 (entspricht 37poligem D-Sub Standard Steckverbindergehäuse) **
- 50-78** 78 contacts in shell size 5 (corresponds to 50 pin D-Sub standard connector shell) **
*78-polig in Gehäusegröße 5 (entspricht 50poligem D-Sub Standard Steckverbindergehäuse) ***

* Retentionsystem of plastic / *Kontakthalteclip aus Kunststoff*
 ** Retentionsystem of metal / *Kontakthalteclip aus Metall*

Contact Type / *Kontaktart*

- P** Pin / *Stift*
- S** Socket / *Buchse*

Contact Design / *Kontaktvariante*

- 7** Crimp termination / *Crimpanschluss*

Modifications / *Modifikationen*



Pin: Crimp Termination

Stift: Crimpanschluss

Dimensions

Abmessungen

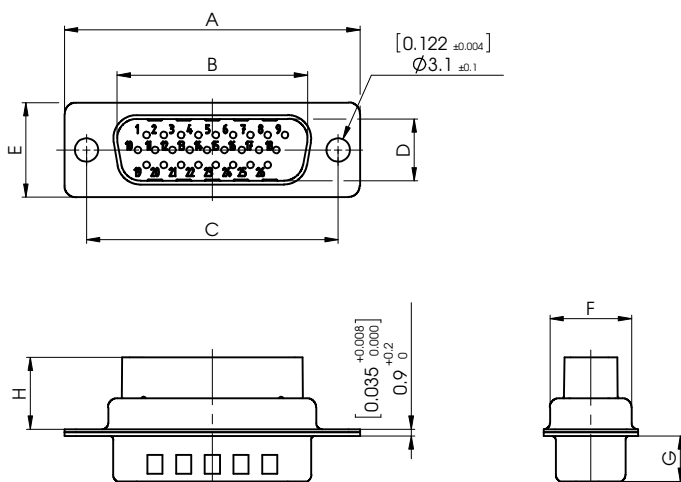

Pin Connector without Contacts, Front View

Stiftsteckverbinder ohne Kontakte, Frontansicht

15 contacts
15 Kontakte

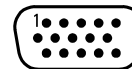

26 contacts
26 Kontakte



44 contacts
44 Kontakte

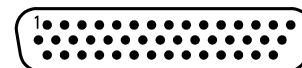

62 contacts
62 Kontakte

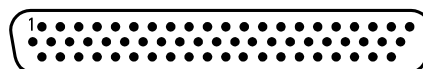

78 contacts
78 Kontakte

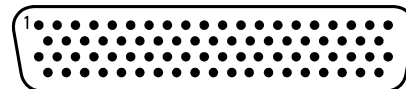

Dimensions

Abmessungen

Order Number <i>Bestellnummer</i>	Shell Size <i>Gehäusegröße</i>	Number of Contacts <i>Polzahl</i>	A $\pm 0,4$ (± 0.016)	B $+0,2$ ($+0.008$)	C $\pm 0,15$ (± 0.006)	D $+0,2$ ($+0.008$)	E $\pm 0,4$ (± 0.016)	F $\pm 0,3$ (± 0.012)	G $-0,3$ (-0.012)	H
FL09-15P7	1	15	30,8 (1.213)	16,9 (0.665)	25,0 (0.984)	8,2 (0.323)	12,5 (0.492)	10,8 (0.425)	6,1 (0.240)	8,95 (0.352)
FL15-26P7	2	26	39,1 (1.539)	25,2 (0.992)	33,3 (1.311)	8,2 (0.323)	12,5 (0.492)	10,8 (0.425)	6,1 (0.240)	8,95 (0.352)
FL25-44P7	3	44	53,0 (2.087)	38,9 (1.531)	47,04 (1.852)	8,2 (0.323)	12,5 (0.492)	10,8 (0.425)	6,0 (0.236)	8,95 (0.352)
FL37-62P7	4	62	69,3 (2.728)	55,3 (2.177)	63,5 (2.500)	8,2 (0.323)	12,5 (0.492)	10,8 (0.425)	6,0 (0.236)	8,95 (0.352)
CT50-78P7	5	78	66,9 (2.634)	52,8 (2.079)	61,1 (2.406)	11,0 (0.433)	15,4 (0.606)	13,7 (0.539)	6,0 (0.236)	9,50 (0.374)



High Density Crimp connectors are supplied without contacts. Crimp contacts must be ordered separately. See page 19 and 20.

High Density Crimpsteckverbinder werden serienmäßig ohne Kontakte geliefert. Crimpkontakte müssen extra bestellt werden. Siehe Seite 19 und 20.



Socket: Crimp Termination

Buchse: Crimpanschluss

Dimensions

Abmessungen

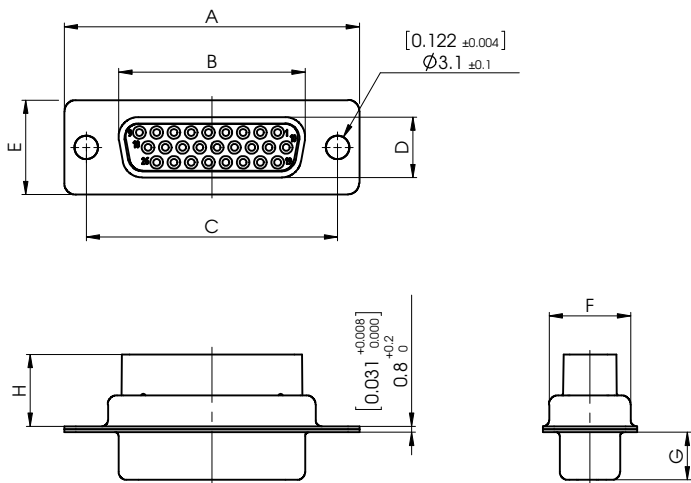

Socket Connector without Contacts, Front View

Buchsensteckverbinder ohne Kontakte, Frontansicht

15 contacts
15 Kontakte

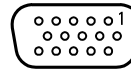

26 contacts
26 Kontakte

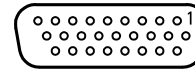

44 contacts
44 Kontakte

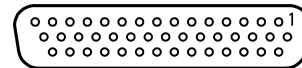

62 contacts
62 Kontakte

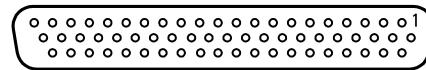

78 contacts
78 Kontakte

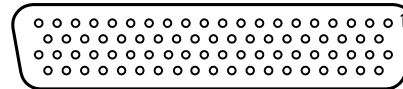

Dimensions

Abmessungen

Order Number <i>Bestellnummer</i>	Shell Size <i>Gehäusegröße</i>	Number of Contacts <i>Polzahl</i>	A ±0,4 (±0.016)	B -0,2 (-0.008)	C ±0,15 (±0.006)	D -0,2 (-0.008)	E ±0,4 (±0.016)	F ±0,3 (±0.012)	G -0,25 (-0.012)	H
FL09-15S7	1	15	30,8 (1.213)	16,4 (0.646)	25,0 (0.984)	8,0 (0.315)	12,5 (0.492)	10,8 (0.425)	6,3 (0.248)	8,95 (0.352)
FL15-26S7	2	26	39,1 (1.539)	24,7 (0.972)	33,3 (1.311)	8,0 (0.315)	12,5 (0.492)	10,8 (0.425)	6,3 (0.248)	8,95 (0.352)
FL25-44S7	3	44	53,0 (2.087)	38,5 (1.516)	47,04 (1.852)	8,0 (0.315)	12,5 (0.492)	10,8 (0.425)	6,3 (0.248)	8,95 (0.352)
FL37-62S7	4	62	69,3 (2.728)	54,9 (2.161)	63,5 (2.500)	8,0 (0.315)	12,5 (0.492)	10,8 (0.425)	6,3 (0.248)	8,95 (0.352)
CT50-78S7	5	78	66,9 (2.634)	52,5 (2.067)	61,1 (2.406)	10,8 (0.425)	15,4 (0.606)	13,7 (0.539)	5,9 ±0,2 (0.232 ±0.008)	9,50 (0.374)



High Density Crimp connectors are supplied without contacts. Crimp contacts must be ordered separately. See page 19 and 20.

High Density Crimpsteckverbinder werden serienmäßig ohne Kontakte geliefert. Crimpkontakte müssen extra bestellt werden. Siehe Seite 19 und 20.



Stamped Crimp Contacts

Gestanzte Crimpkontakte

Pin

Stift

P110



Socket

Buchse

S110



Ordering Information

Bestellinformationen

The stamped crimp contacts for high density D-Sub connectors are available in reels of 300, 2,000 pcs or 10,000 pcs. The contacts are selectively gold plated in the mating area.

For crimping tools please see page 28.

Die gestanzten Kontakte für High Density D-Sub Steckverbinder sind auf einer Rolle zu 300, 2.000 Stück oder zu 10.000 Stück lieferbar. Die Kontakte sind im Steckbereich selektiv vergoldet.

Verarbeitungswerkzeuge siehe Seite 28.

Technical Data

Technische Daten

Specifications	
Technische Beschreibung	
Material <i>Material</i>	Copper alloy <i>Kupferlegierung</i>
Contact size <i>Kontaktgröße</i>	AWG22, pin Ø 0,76 mm (Ø 0.030") <i>AWG22, Stift Ø 0,76 mm</i>
Matching wire sizes <i>Passende Drahtgrößen</i>	AWG 24 - 28

Wire Size (AWG) <i>Drahtgröße (AWG)</i>	Order Number <i>Bestellnummer</i>	Au (over Ni) <i>Au über Ni</i>	Type <i>Typ</i>
24-28	P110-01V...*	≤ 0,1 μm (4 microinches)	Pin / <i>Stift</i>
24-28	P110-06V...	≥ 0,6 μm (25 microinches)	Pin / <i>Stift</i>
24-28	S110-01V...*	≤ 0,1 μm (4 microinches)	Socket / <i>Buchse</i>
24-28	S110-06V...	≥ 0,6 μm (25 microinches)	Socket / <i>Buchse</i>

* on request / *auf Anfrage*

Packing Unit

Verpackungseinheit

Packing Unit (Pieces) <i>Verpackungseinheit (Stück)</i>	Addition to Order Number <i>Bestellnummernergänzung</i>
300	_0300
2000	_2000
10000	_10000

Ordering Example

Bestellbeispiel

P110-06V_2000

P110-06V

Stamped crimp pin contact for wire size 24 - 28, plating: 0.6 μm (25 microinches) Au over Ni.
Gestanzter Crimpstiftkontakt für Drahtgröße AWG 24 - 28, Oberfläche 0,6 μm Au über Ni.

_2000

2,000 pieces on one reel.
2.000 Stück auf einer Rolle.



Turned Crimp Contacts

Gedrehte Crimpkontakte

Pin

Stift



Socket

Buchse



Ordering Information

Bestellinformationen

The turned crimp contacts are available in standard and MIL versions. For the standard contacts, the plating is to 1.3 μm (50 microinches) gold over nickel, and for the MIL contacts it is 1.3 μm (50 microinches) gold over nickel.

For crimping tools please see top of page 26.

Die gedrehten Crimpkontakte sind in einer Standard- sowie einer MIL-Ausführung lieferbar. Bei den Standardkontakten beträgt die Oberflächenschichtstärke bis 1,3 μm Au, bei den MIL-Kontakten 1,3 μm Au, jeweils über Nickel.

Verarbeitungswerkzeuge siehe Seite 26 oben.

Technical Data

Technische Daten

Specifications	
Technische Beschreibung	
Material	Copper alloy
Material	Kupferlegierung
Contact Size	22, pin \varnothing 0,76 mm (\varnothing 0.030")
Kontaktgröße	22, Stift \varnothing 0,76 mm
Matching wire size	AWG 24 - 28
Passende Drahtgröße	

Order Number	MIL-No.	Au (over Ni)	Type
Bestellnummer	MIL-Nummer	Au über Ni	Typ
FK22PL-02V...		0,2 μm (8 microinches)	Pin / Stift
FK22SL-02V...		0,2 μm (8 microinches)	Socket / Buchse
FK22PL-08V...		0,8 μm (31 microinches)	Pin / Stift
FK22SL-08V...		0,8 μm (31 microinches)	Socket / Buchse
FK22PL-13V...		1,3 μm (51 microinches)	Pin / Stift
FK22SL-13V...		1,3 μm (51 microinches)	Socket / Buchse
M39029/58-360	24308/13-1, M39029/58-360	1,3 μm (51 microinches)	Pin / Stift
M39029/57-354	24308/12-1, M39029/57-354	1,3 μm (51 microinches)	Socket / Buchse

Packing Unit

Verpackungseinheit

Packing Unit (Pieces)	Addition to Order Number
Verpackungseinheit (Stück)	Bestellnummernergänzung
100	_0100
1000	_1000
5000	_5000

Ordering example

Bestellbeispiel

FK22SL-08V_0100

FK22SL-08V

Crimp socket contact for wire size 24 - 28, plating 0.8 μm (31 microinches) Au over Ni.
Crimpbuchsenkontakt für Drahtgröße AWG 24 - 28, Oberfläche 0,8 μm Au über Ni.

_0100

100 pieces are packed in one bag.
100 Stück in einem Beutel verpackt.



Accessories

Zubehör

Clinch Nuts

Einnietmuttern

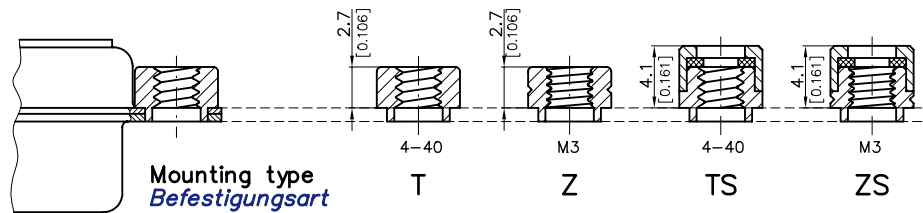

Mounting Type <i>Befestigungsart</i>	Self Locking <i>Selbstsichernd</i>	Surface <i>Oberfläche</i>
T	—	Tin-plated or zinc-plated
Z	—	verzinkt oder verzinkt
TS	•	verzinkt oder verzinkt
ZS	•	verzinkt

Ordering Example

Bestellbeispiel

Pin connector, clinch nut 4-40 UNC, 9 contacts

FLT09-15P7

Stiftsteckverbinder, Einnietmutter 4-40 UNC, 9-polig

FLT09-15P7

Threaded Spacers

Abstandsbolzen

Rear Riveted

Rückseitig vernietet

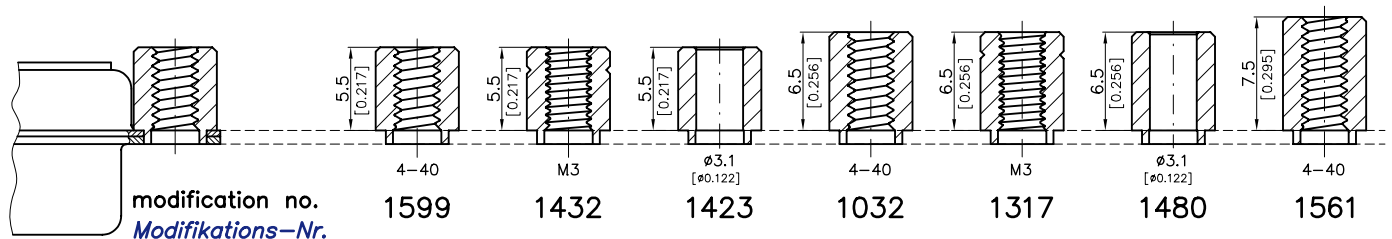

Ordering Example

Bestellbeispiel

Pin connector, 15 contacts, straight PCB termination, rear riveted threaded spacer with inner thread M3 and length 5.5 mm (0.217"):

CT09-15P1-1432

Stiftsteckverbinder, 15-polig, gerader Leiterplattenanschluss, rückseitig vernieteter Abstandsbolzen mit Innengewinde M3 und Länge 5,5 mm:

CT09-15P1-1432

Front Riveted

Frontseitig vernietet

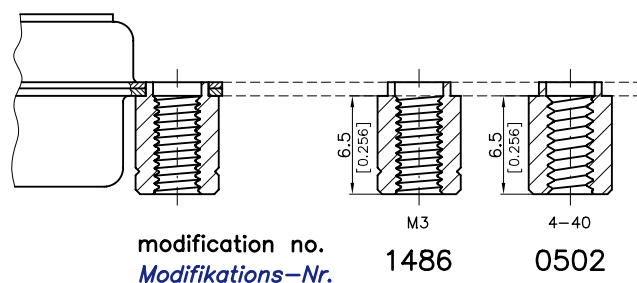

The modification number for the spacers completes the order number for the connector on which they are mounted.

Die Modifikationsnummer des Abstandsbolzens ergänzt die Bestellnummer des Steckverbinders, in den der Abstandsbolzen eingebaut ist.



Frontside Spacers and Rearside Spacers or Snap-in Bolts

Frontseitiger Abstandsbolzen und rückseitiger Abstands- oder Schnappbolzen

Frontside Inner Thread 4-40 UNC

Frontseitiges Innengewinde 4-40 UNC



Frontside Inner Thread M3

Frontseitiges Innengewinde M3



Through Hole Ø 3.1 mm (Ø 0.122")

Durchgangsloch Ø 3,1 mm



Frontside Inner Thread, Rearside Snap-in bolt (Recommended Diameter of the Assembly Drilling 3.0 mm ±0,1 (0.118" ±0.004))

Frontseitiges Innengewinde, rückseitiger Schnappbolzen (empfohlener Durchmesser der Montagebohrungen 3,0 mm ±0,1)

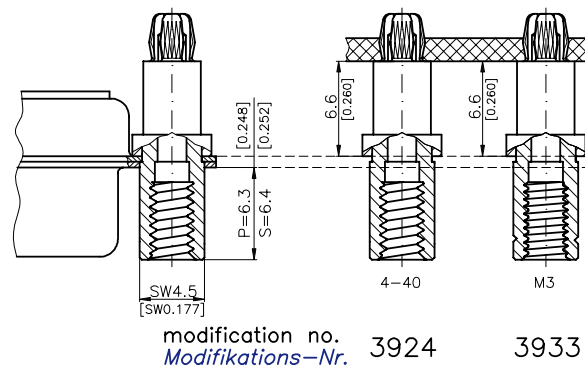

The modification number for the spacers completes the order number for the connector on which they are mounted.

Die Modifikationsnummer des Abstandsbolzens ergänzt die Bestellnummer des Steckverbinders, in den der Abstandsbolzen eingebaut ist.

Surface: Tin-plated (only when using tin-plated shells).

Oberfläche: Verzinkt (Nur in Verbindung mit verzintem Gehäuse.)

Ordering Example

Bestellbeispiel

Pin connector, 15 contacts, straight PCB termination, front and rear side spacers with front side inner thread M3 and rear side inner thread 4-40 UNC, length 5.5 mm (0.217"):

CT09-15P1-1779

Stiftsteckverbinder, 15-polig, gerader Leiterplattenanschluss, front- und rückseitiger Abstandsbolzen mit frontseitigem Innengewinde M3 und rückseitigem Innengewinde 4-40 UNC, Länge 5,5 mm:

CT09-15P1-1779



Snap-in Bolts for PCB Mounting

Schnappbolzen für Leiterplattenmontage

For PCBs with 1.6 mm (0.063") Thickness (Recommended Diameter of the Assembly Drilling 3.0 mm ±0,1 (0.118" ±0.004))

Für Leiterplatten mit 1,6 mm Stärke (empfohlener Durchmesser der Montagebohrungen 3,0 mm ±0,1)

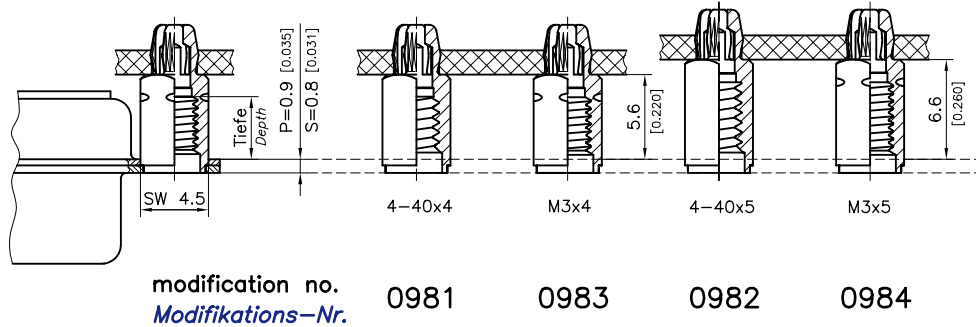

For PCBs with 2.4 mm (0.094") and 3.2 mm (0.126") Thickness

(Recommended Diameter of the Assembly Drilling 3.0 mm ±0,1 (0.118" ±0.004))

Für Leiterplatten mit 2,4 mm und 3,2 mm Stärke (empfohlener Durchmesser der Montagebohrungen 3,0 mm ±0,1)

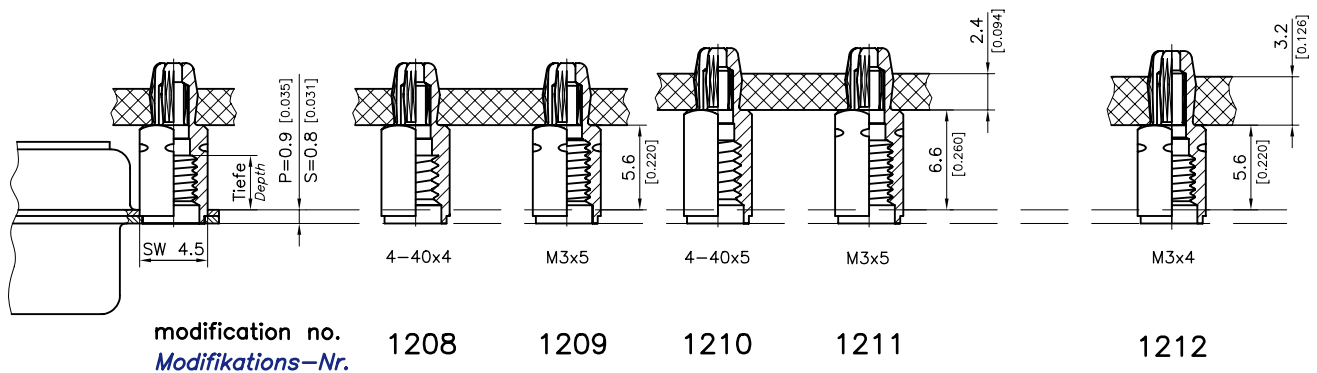

Female Screw Locks F-GSCH1/5...

Sechskantbolzen F-GSCH1/5...

Hex. 0.177"

Schlüsselweite 4,5

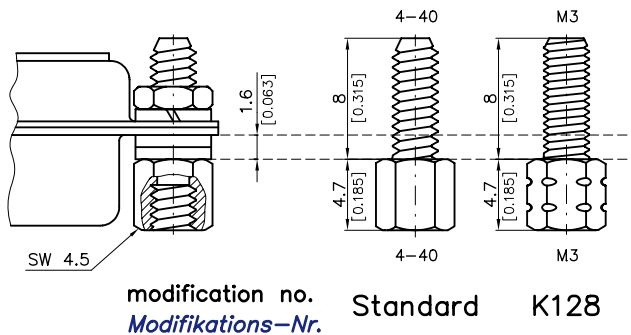

Further Accessories are listed in our D-Sub miniature connector catalogue.
 Weiteres Zubehör ist in unserem D-Sub Miniatur Steckverbinder Katalog aufgeführt.



Shielded Right Angled Adapter, Screwable

Geschirmter Winkeladapter, verschraubbar

Special Features

Besondere Merkmale



FAW1PS...



FAW5W1SP..



FAW1HPS...

- May be used as a bracket adaptor, e.g. in narrow installation conditions
- Suitable for robust application
- Very good shielding properties
- No loose component or assembly parts, screws are pre-mounted
- A change in the termination direction is facilitated with "reverse" mounted contacts
- Very good electrical properties through the use of one-piece contacts
- For D-Sub Miniatur, High-Density and Mixed Layout connectors
- RoHS conform

- *nutzbar als Winkeladapter, z.B. bei beengten Einbauverhältnissen*
- *für robuste Einsätze geeignet*
- *sehr gute Abschirmeigenschaften*
- *keine losen Einzel- und Montageteile, Verriegelungsschrauben vormontiert*
- *Änderung der Anschlussrichtung durch „reverse“ montierte Kontakte*
- *sehr gute elektrische Eigenschaften durch Verwendung von einteiligen Kontakten*
- *für D-Sub Miniatur, High Density und Mixed Layout Steckverbindern*
- *RoHS konform*

Ordering Code, Use Contact Type and Direction of Right Angled Contacts

Bestellschlüssel, Nutzung Kontaktart und Richtung der abgewinkelten Kontakte

Appliance Side
geräteseitig



FAW1PS

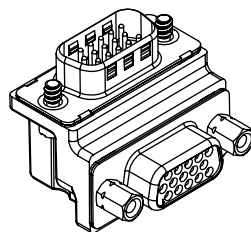

FAW1HPSR



FAW1SP

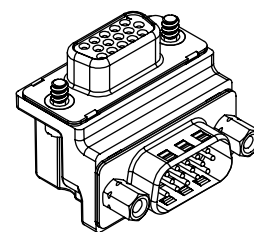

FAW1HSPR

Termination Side
anschlusseitig



Ordering Code

Bestellschlüssel

FAW **1** **H** **PS** **G1** **U** - ...

Series Prefix / *Serienbezeichnung*

Insulator / *Isolierkörper*

- Standard = Thermoplastic / *Thermoplast*
- M** Polyester glass filled, zinc plated shell, pin connectors without dimples
Polyester, glasfaserverstärkt, Gehäuseoberfläche verzinkt, Stiftsteckverbinder ohne Kontaktnoppen
- NO PERFORMANCE CLASSES!** / **KEINE GÜTESTUFEN!**
- H** PCT, heat resistant, please check availability
PCT, hochtemperaturbeständig, Liefermöglichkeiten auf Anfrage

No. of Contacts / *Polzahl*

Also as Mixed Layout, e. g. 5W1
auch als Mixed Layout, z. B. 5W1

09(15)	15(26)	25(44)	37(62)	50(78)
1	2	3	4	5

Shell size / *Gehäusegröße*

Shell size 1 is available, further shell sizes on request
Gehäusegröße 1 ist verfügbar, weitere Gehäusegrößen auf Anfrage

Type of connector / *Steckverbindertyp*

- Standard D-Sub Miniatur connector/ *Standard D-Sub Miniatur Steckverbinder*
- H** High Density connector / *High Density Steckverbinder*

Contact Type / *Kontaktart*

- PS** Pin contacts appliance side, socket contacts termination side
Stiftkontakte geräteseitig, Buchsenkontakte anschlussseitig
- SP** Socket contacts appliance side, pin contacts termination side
Buchsenkontakte geräteseitig, Stiftkontakte anschlussseitig

Direction of Right Angled Contacts / *Richtung der abgewinkelten Kontakte*

- Standard / *Standard*
- R** Reverse / *Revers*

Performance Classes Available in Accordance with DIN 41652

Lieferbare Gütestufen nach DIN 41652

Standard insulator / *Standardisolierkörper*

- G1** = 500 Contact cycle / *Steckzyklen* = Performance class 1 / *Gütestufe 1*
 - G2** = 200 Contact cycle / *Steckzyklen* = Performance class 2 / *Gütestufe 2*
 - G3** = 50 Contact cycle / *Steckzyklen* = Performance class 3 / *Gütestufe 3*
- Pin connector with dimples / *Stiftsteckverbinder mit Kontaktnoppen*

Mounting Type / *Befestigungsarten*

	Termination side / <i>anschlussseitig</i>	Appliance side / <i>geräteseitig</i>
U	Female Screw Lock 4-40 / <i>Sechskantbolzen 4-40</i>	Screw 4-40 / <i>Schraube 4-40</i>
UM3	Female Screw Lock 4-40 / <i>Sechskantbolzen 4-40</i>	Screw M3 / <i>Schraube M3</i>
M	Female Screw Lock M3 / <i>Sechskantbolzen M3</i>	Screw 4-40 / <i>Schraube 4-40</i>
MM3	Female Screw Lock M3 / <i>Sechskantbolzen M3</i>	Screw M3 / <i>Schraube M3</i>

Modifications / *Modifikationen*



Technical Data

Technische Daten

Mechanical Data

Mechanische Daten

Mechanical Data <i>Mechanische Daten</i>	
Mating force per signal contact <i>Steckkraft pro Signalkontakt</i>	≤ 3,4 N
Unmating force per signal contact <i>Ziehkraft pro Signalkontakt</i>	≥ 0,2 N
max. torque * <i>max. Anzugsmoment *</i>	40 Ncm (0,295 ft.lb.) <i>40 Ncm</i>

* Not for locking screws

* *Nicht für Verriegelungsschrauben*

Electrical Data

Elektrische Daten

Electrical Data <i>Elektrische Daten</i>	
Current rating at room temperature <i>Maximale Stromstärke bei Raumtemperatur</i>	5 A
Test voltage between 2 contacts / shell and contact <i>Prüfspannung zwischen 2 Kontakten bzw. Kontakt und Gehäuse</i>	1200 V / 1 min.
Meets transition resistance requirements per contact pair in line with DIN 41652: <i>Erfüllt Übergangswiderstand pro Kontaktpaar nach DIN 41652 für:</i>	
- Right angled contacts / <i>abgewinkelte Kontakte</i>	≤ 25 mΩ
- Right angled contacts - 50 way / <i>abgewinkelte Kontakte bei 50 Polen</i>	≤ 35 mΩ
Insulation resistance between contacts <i>Isolationswiderstand Kontakt / Kontakt</i>	≥ 5000 MΩ
Volume resistivity <i>Spezifischer Durchgangswiderstand</i>	10 ¹⁶ Ω cm
Dielectric strength <i>Spezifische Durchschlagsfestigkeit</i>	50 kV / mm

Materials and Platings

Materialien und Oberflächen

Materials and Platings <i>Materialien und Oberflächen</i>			
Shell <i>Gehäuse</i>	Steel <i>Stahl</i>		
Type / <i>Type</i>	F	FH	FM
Insulator <i>Isolierkörper</i>	Polyester, glass filled (UL94V-0), white <i>Polyester, glasfaserverstärkt (UL94V-0), weiß</i>	Polyester, heat resistant, glass filled (UL94V-0), natural <i>Polyester, hochtemperaturbeständig, glasfaserverstärkt (UL94V-0), natur</i>	Polyester, glass filled (UL94V-0), green <i>Polyester, glasfaserverstärkt (UL94V-0), grün</i>
Temperature range <i>Temperaturbereich</i>	-35°C to 100°C (-67°F to 212°F) <i>-35°C bis 100°C</i>		
Shell plating (standard) <i>Gehäuseoberfläche (Standard)</i>	Tin plated over nickel <i>verzinkt über Nickel</i>		Blue chromate over zinc plating <i>verzinkt und blau chromatiert</i>
Shell (standard) <i>Gehäuse (Standard)</i>	Pin connector shell with dimples <i>Stiftsteckverbindergehäuse mit Kontaktnoppen</i>		Pin connector shell without dimples <i>Stiftsteckverbindergehäuse ohne Kontaktnoppen</i>
Shell (K120) <i>Gehäuse (K120)</i>			Tin plated over nickel, pin connector shell with dimples <i>verzinkt über Nickel, Stiftsteckverbindergehäuse mit Kontaktnoppen</i>
Shell (K121) <i>Gehäuse (K121)</i>			Tin plated over nickel, socket connector shell without dimples <i>verzinkt über Nickel, Buchsensteckverbindergehäuse ohne Kontaktnoppen</i>
Contact material <i>Kontaktmaterial</i>	Copper alloy <i>Kupfer-Legierung</i>		



Dimensions

Abmessungen

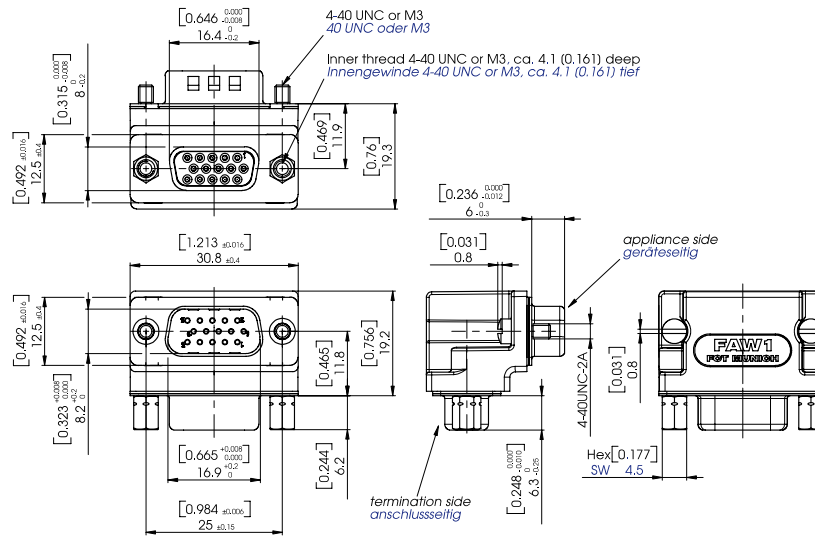

Order Number <i>Bestellnummer</i>	A	B	C	D
	±0,3 (±0.012)	±0,2 (±0.008)	±0,15 (±0.016)	±0,2 (±0.008)
FAW1	30,8 (1.213)	16,9 (0.665)	25,0 (0.984)	16,4 (0.646)
FAW2	39,1 (1.539)	25,2 (0.992)	33,3 (1.311)	24,7 (0.972)
FAW3	52,8 (2.079)	38,9 (1.532)	47,0 (1.850)	28,5 (1.122)
FAW4	69,3 (2.728)	55,3 (2.177)	63,5 (2.500)	54,9 (2.161)

Size 2 - 5 on request
Größe 2 - 5 auf Anfrage

Application Example

Einsatzbeispiel

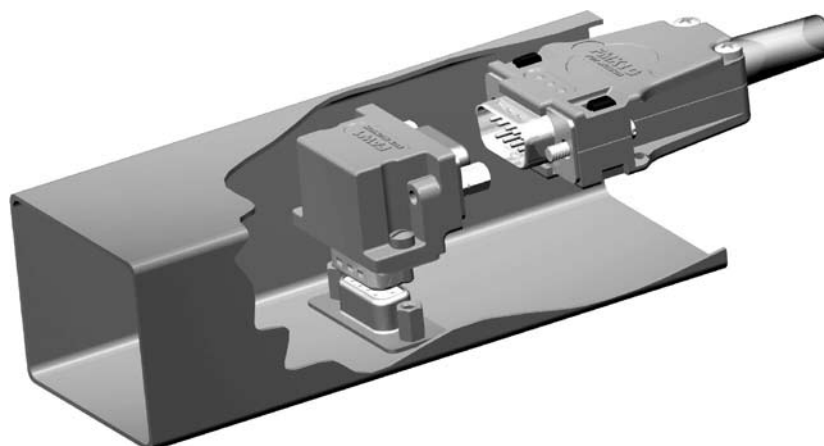



Crimping Tools

Crimpwerkzeuge

For Stamped Contacts

Für gestanzte Kontakte

Hand Crimping Tool for Reels of 300 pcs

Handcrimpzange für Rollen mit 300 Stück

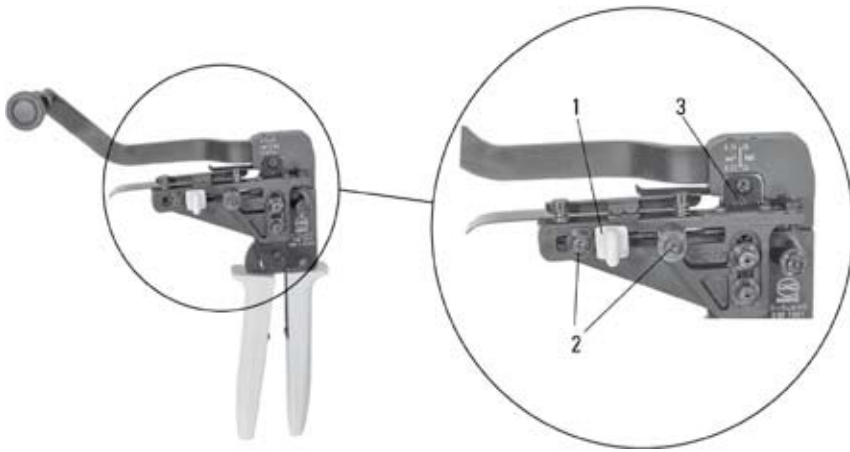

- 1: Contact feeder adjustment
Vorschubeinrichtung
- 2: Feeder setting for contact band
Vorschubeinstellung des Kontaktbandes
- 3: Wire sizes: AWG 24 - 26 (F1839)
Drahtgrößen: WG 24 - 26 (F1839)

The FCT hand crimping tool **F1839** is suitable for use with stamped contacts on a reel. With this tool, contacts for wire sizes AWG 24 –28 can be easily crimped. The hand crimping tool has manual adjustment for contact alignment, a waste cutter for contacts on a reel and contact centring to ensure a fast, inexpensive crimping process, entry from left side.

*Die Handcrimpzange **F1839** von FCT ist für gestanzte Kontakte auf Rollen geeignet. Mit dieser Handzange können ohne großen Aufwand Kontakte für die Drahtgrößen AWG 24 – 28 verarbeitet werden. Sie besitzt eine manuelle Vorschubeinrichtung, einen Trennschneider für Bandkontakte sowie eine Kontaktzentrierung für schnelle, kostengünstige Verarbeitung, Zuführung von der linken Seite.*

Order number / *Bestellnummer:* **F1839**

Mechanical Processing for Reels with 2,000 and 10,000 pcs

Maschinelle Verarbeitung für Rollen mit 2.000 und 10.000 Stück

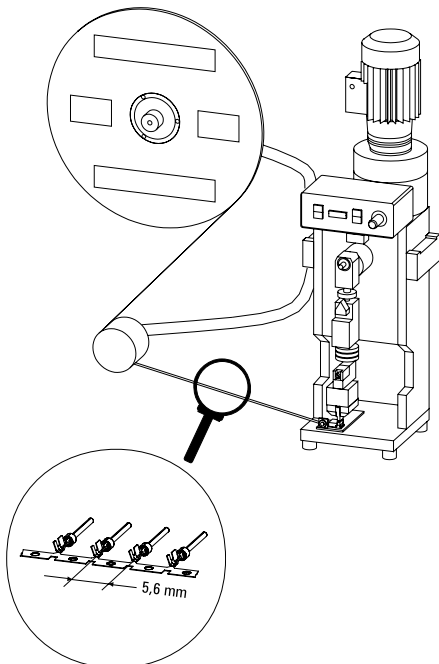

Entry from left side with turn round..
Zuführung von der linken Seite mit Umlenkung.

The distance between the contacts has changed.
Der Abstand zwischen den Kontakten hat sich geändert.



For Turned MIL- and Standard Contacts

Für gedrehte MIL- und Standardkontakte

Hand Crimping Tool

Handcrimpzange

Order number: M22520/2-01

Bestellnummer:



When crimping contacts it is necessary to use a corresponding insert.

Beim Crimpen muss immer ein Einsatz für den entsprechenden Kontakt verwendet werden.



Positioner for Socket Contacts

Einsatz für Buchsenkontakte

Order number: M22520/2-06

Bestellnummer:



Positioner for Pin Contacts

Einsatz für Stiftkontakte

Order number: M22520/2-09

Bestellnummer:



Insertion and Extraction Tools

Ein- und Ausbauwerkzeuge

Plastic Insertion / Extraction Tool

Ein- / Ausbauwerkzeug aus Kunststoff

Order number: M81969/14-01

Bestellnummer:



Plastic Insertion / Extraction Tool with Metal Clips

Ein- / Ausbauwerkzeug aus Kunststoff mit Metallspitzen

Order number: M81969/1-04

Bestellnummer:



Insertion Tool - Metal Tweezers

Einbauwerkzeug - Metallpinzette

Order number: M81969/8-01

Bestellnummer:



Extraction Tool - Metal Tweezers

Ausbauwerkzeug - Metallpinzette

Order number: M81969/8-02

Bestellnummer:





Waterproof Connector Systems

Wasserdichte Steckverbindersysteme

Ordering Code for Waterproof Connectors

Bestellschlüssel für wasserdichte Steckverbinder

UL Recognized File No. E168813 

The waterproofness of the end appliance is not content of the UL-inspection
Die Wasserdichtheit des Endsystems ist nicht Inhalt der UL-Prüfung..

FWD R 09-15 P 1 - K...

Series prefix for waterproof D-Sub connectors
Serienbezeichnung für wasserdichte D-Sub Steckverbinder

F Front side mounting (for solder pot termination only)
Frontseitig montierbar (nur für Löttopfanschluss)

R Rear side mounting / *Rückseitig montierbar*

No. of Contacts / <i>Polzahl</i>	09-15	15-26	25-44	37-62	50-78
Shell Size / <i>Gehäusegröße</i>	1	2	3	4	5

Contact Type / *Kontaktart*

P Pin contacts / *Stiftkontakte*

S Socket contacts / *Buchsenkontakte*

Contact Design / *Kontaktvariante*

□ Solder pot termination / *Löttopfanschluss*

1 Straight PCB termination / *Gerader Einlötkontakt*

Modifications / *Modifikationen*



Technical Data

Technische Daten

Mechanical Data

Mechanische Daten

Mechanical Data <i>Mechanische Daten</i>	
Protection standard / <i>Schutzart</i>	DIN EN 60529 - IP 67
Operating temperature range <i>Betriebstemperaturbereich</i>	-25 °C bis +70 °C (-13 °F to +158 °F)

Electrical Data

Elektrische Daten

Electrical Data <i>Elektrische Daten</i>	
Current rating <i>Maximale Stromstärke</i>	3 A
Test voltage between 2 contacts / shell and contact <i>Prüfspannung zwischen 2 Kontakten bzw. Kontakt und Gehäuse</i>	1000 V
Insulation resistance <i>Isolationswiderstand</i>	≥ 3000 MΩ
Contact resistance <i>Durchgangswiderstand</i>	≤ 15 mΩ

Materials and Platings

Materialien und Oberflächen

Materials and Platings <i>Materialien und Oberflächen</i>	
Shell <i>Gehäuse</i>	Brass, tin plated over nickel <i>Messing, verzinkt über Nickel</i>
Insulator <i>Isolierkörper</i>	Thermoplastic, glass filled (UL94V-0) <i>Thermoplast, glasfaserverstärkt (UL94V-0)</i>
Metal watertight frame <i>Metalldichtrahmen</i>	nickel plated zinc die-cast <i>Zinkdruckguss, vernickelt</i>
Contact material <i>Kontaktmaterial</i>	Copper alloy <i>Kupfer-Legierung</i>
Contacts <i>Kontakte</i>	Machined, copper alloy, 0.3 μm (11 micrometers) Au over Ni, termination area tin plated <i>gedreht, Kupferlegierung, 0,3 μm Au über Nickel, Anschlussbereich verzinkt</i>
Waterproofing elements <i>Dichtelement</i>	Silicone <i>Silikon</i>



Waterproof Connectors with Metal Watertight Frame

Wasserdichte Steckverbinder mit Metaldichtrahmen

Connectors with Solder Pot Termination, Front Mounting

Steckverbinder mit Löttopfanschluss, frontseitige Montage

Watertight frame for fixing on the front side of the mounting plate
 Dichtrahmen zur Befestigung auf der Frontseite der Montageplatte

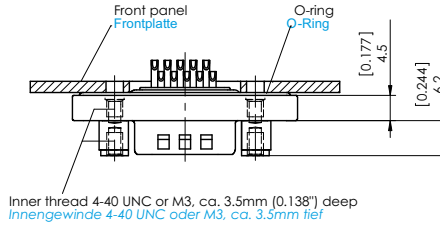
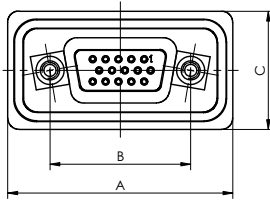

Inner thread 4-40 UNC or M3, ca. 3.5mm [0.138"] deep
 Innengewinde 4-40 UNC oder M3, ca. 3.5mm tief

Connectors with Solder Pot Termination, max. AWG 22 Steckverbinder mit Löttopfanschluss, max. AWG 22							
Number of Contacts Polzahl	A ±0,2 (±0.008)	B ±0,1 (±0.004)	C ±0,2 (±0.008)	Order number pin Bestellnummer Stift	Order Number Socket Bestellnummer Buchse	Inner Thread Innengewinde	
						4-40 UNC	M3
9-15	40,0 (1.575)	25,0 (0.984)	21,0 (0.827)	FWDFM09-15P-K1444*	FWDFM09-15S-K1444	Standard Standard	*
15-26	48,3 (1.902)	33,3 (1.311)	21,0 (0.827)	FWDFM15-26P-K1444*	FWDFM15-26S-K1444*	Standard Standard	*
25-44	62,0 (2.441)	47,04 (1.852)	21,00 (0.827)	FWDFM25-44P-K1444*	FWDFM25-44S-K1444*	Standard Standard	*
37-62	78,5 (3.091)	63,5 (2.500)	21,0 (0.827)	FWDFM37-62P-K1444*	FWDFM37-62S-K1444*	Standard Standard	*
50-78	76,1 (2.996)	61,1 (2.406)	23,2 (0.913)	FWDFM50-78P-K1444*	FWDFM50-78S-K1444*	Standard Standard	*

* and Modification K1444 on request
 * und Modifikation K1444 auf Anfrage

Connectors with Solder Pot Termination, Rear Mounting

Steckverbinder mit Löttopfanschluss, rückseitige Montage

Watertight frame for fixing on the rear side of the mounting plate
 Dichtrahmen zur Befestigung auf Rückseite der Montageplatte

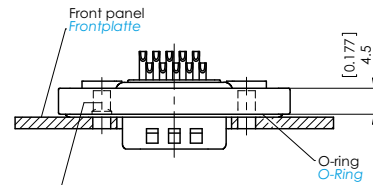
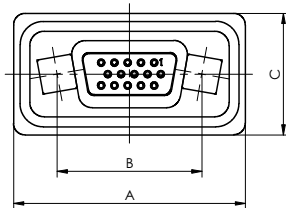

Inner thread 4-40 UNC or M3, ca. 3.5mm [0.138"] deep
 Innengewinde 4-40 UNC oder M3, ca. 3.5mm tief

Connectors with Solder Pot Termination, max. AWG 22 Steckverbinder mit Löttopfanschluss, max. AWG 22							
Number of Contacts Polzahl	A ±0,2 (±0.008)	B ±0,1 (±0.004)	C ±0,2 (±0.008)	Order Number Pin Bestellnummer Stift	Order Number Socket Bestellnummer Buchse	Inner Thread Innengewinde	
						4-40 UNC	M3
9-15	40,0 (1.575)	25,0 (0.984)	21,0 (0.827)	FWDRM9-15P-K1444*	FWDRM9-15S-K1444	Standard Standard	*
15-26	48,3 (1.902)	33,3 (1.311)	21,0 (0.827)	FWDRM15-26P-K1444*	FWDRM15-26S-K1444*	Standard Standard	*
25-44	62,0 (2.441)	47,04 (1.852)	21,00 (0.827)	FWDRM25-44P-K1444*	FWDRM25-44S-K1444*	Standard Standard	*
37-62	78,5 (3.091)	63,5 (2.500)	21,0 (0.827)	FWDRM37-62P-K1444*	FWDRM37-62S-K1444*	Standard Standard	*
50-78	76,1 (2.996)	61,1 (2.406)	23,2 (0.913)	FWDRM50-78P-K1444*	FWDRM50-78S-K1444*	Standard Standard	*

* and Modification K1444 on request
 * und Modifikation K1444 auf Anfrage



Waterproof Connectors with Metal Watertight Frame

Wasserdichte Steckverbinder mit Metaldichtrahmen

Connectors with Straight PCB Termination

Steckverbinder mit geradem Leiterplattenanschluss

Watertight frame for fixing on the rear side of the mounting plate
 Dichtrahmen zur Befestigung auf der Rückseite der Montageplatte

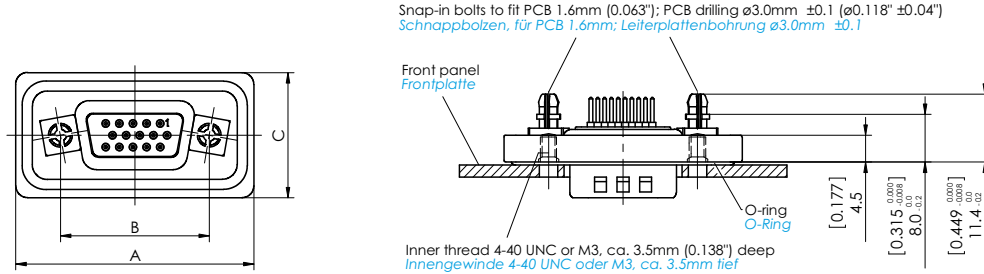

Connectors with Straight PCB Termination, $\varnothing 0.6\text{ mm}$ ($\varnothing 0.024"$), Pre-tinned Steckverbinder mit geradem Einlötlschluss, $\varnothing 0,6\text{ mm}$, vorverzinkt							
Number of Contacts Polzahl	A $\pm 0,2$ (± 0.008)	B $\pm 0,1$ (± 0.004)	C $\pm 0,2$ (± 0.008)	Order Number Pin Bestellnummer Stift	Order Number Socket Bestellnummer Buchse	Inner Thread Innengewinde	
						4-40 UNC	M3
9-15	40,0 (1.575)	25,0 (0.984)	21,0 (0.827)	FWDRM9-15P1-K1676*	FWDRM9-15S1-K1676*	Standard Standard	*
15-26	48,3 (1.902)	33,3 (1.311)	21,0 (0.827)	FWDRM15-26P1-K1676	FWDRM15-26S1-K1676*	Standard Standard	*
25-44	62,0 (2.441)	47,04 (1.852)	21,00 (0.827)	FWDRM25-44P1-K1676	FWDRM25-44S1-K1676*	Standard Standard	*
37-62	78,5 (3.091)	63,5 (2.500)	21,0 (0.827)	FWDRM37-62P1-K1676	FWDRM37-62S1-K1676*	Standard Standard	*
50-78	76,1 (2.996)	61,1 (2.406)	23,2 (0.913)	FWDRM50-78P1-K1676	FWDRM50-78S1-K1676*	Standard Standard	*

* and Modification K1676 on request
 * und Modifikation K1676 auf Anfrage

PCB hole pattern: see page 10-11

Leiterplattenlochbilder: siehe Seite 10-11

Ordering Data (Waterproof D-Sub Connectors for FWH Hoods)

Bestelldaten (wasserdichte D-Sub Steckverbinder für Hauben FWH)

Pin Connector

Stiftsteckverbinder

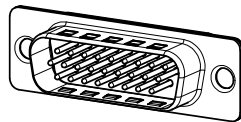

Order Number Bestellnummer	Shell Size Gehäusegröße	Number of Contacts Polzahl
CT09-15P-2429	1	9-15
CT15-26P-2429	2	15-26
CT25-44P-2429	3	25-44
CT37-62P-2429	4	37-62
CT50-78P-2429	5	50-78

Socket Connector

Buchsensteckverbinder



Order Number Bestellnummer	Shell Size Gehäusegröße	Number of Contacts Polzahl
CT09-15S-2429	1	9-15
CT15-26S-2429	2	15-26
CT25-44S-2429	3	25-44
CT37-62S-2429	4	37-62
CT50-78S-2429	5	50-78

Packing Unit Verpackungseinheit	
Modification on request 2 locking screws 2 washers 1 front seal 2 distance bolts	Modifikation auf Anfrage 2 St. Verriegelungsschrauben 2 St. Unterlegscheiben 1 St. Frontdichtung 2 St. Abstandsbolzen

Information / Information:
 D-Sub pin and socket connectors for waterproof hoods are only available for solder pot terminations.
 Die D-Sub Stift- und Buchsensteckverbinder für wasserdichte Hauben sind nur mit Löttopfanschluss verfügbar.



For information on FWH hoods, please refer to our hoods catalogue.
 Informationen zur Haube FWH entnehmen Sie bitte unserem Haubenkatalog.



Front Mounting

Frontseitige Montage

Illustration:
Mounting on the outer side of a machine with type **FWDFM09-15P** (please also see page 14).

Abbildung:
Montage auf der Geräteaußenseite bei Typ **FWDFM09-15P** (siehe auch Seite 14).

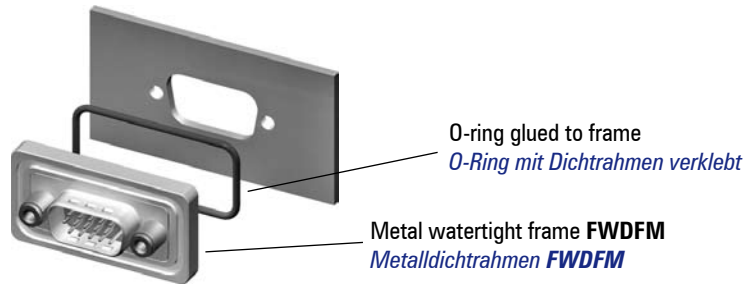

Rear Mounting

Rückseitige Montage

Illustration and drawing:
Mounting on the inside of a machine with type **FWDRM09-15P** (please also see page 14).

Abbildung und Zeichnung:
Montage auf der Geräteinnenseite bei Typ **FWDRM09-15P** (siehe auch Seite 14).

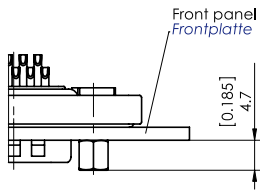

Distance Bolts Available <i>Lieferbare Abstandsbolzen</i>	
Inner and Outer Thread <i>Innen- und Außengewinde</i>	Order Number <i>Bestellnummer</i>
M3	F-GSCH1/5-K834
4-40 UNC	F-GSCH1/5-K835

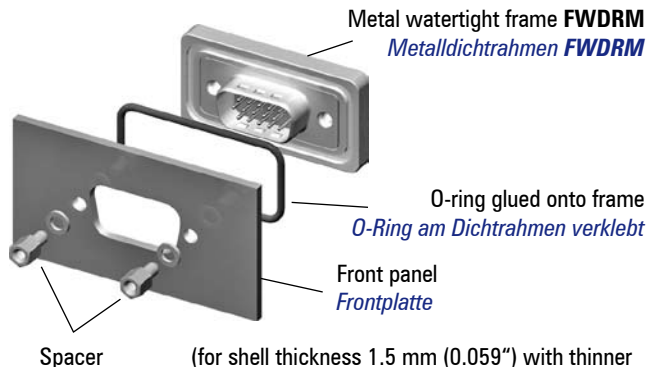

(for shell thickness 1.5 mm (0.059") with thinner front panel, washers are required, which are included in the delivery.)

Abstandsbolzen (für Gehäusewandstärke 1,5 mm, bei geringerer Stärke sind Unterlegscheiben notwendig, die im Lieferumfang enthalten sind.)

Accessories for Pin Connectors

Zubehör für Stiftsteckverbinder

Front Seal

Frontdichtung

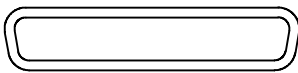

Order Number <i>Bestellnummer</i>	Shell Size <i>Gehäusegröße</i>	Number of Contacts <i>Polzahl</i>
F1043-1F	1	9-15
F1043-2F	2	15-26
F1043-3F	3	25-44
F1043-4F	4	37-62
F1043-5F	5	50-78

Material Specification <i>Materialbeschreibung</i>	
Material <i>Material</i>	Silicone <i>Silikon</i>
Thickness <i>Dicke</i>	1,1 <i>(0.04)</i>



Front seals are used to seal off the connection area of the signal contacts (combination **FWD...** with High Density D-Sub connectors **...-2429**) and are mounted in male connectors (see drawing). They can also be used with standard D-Sub connectors.

*Frontdichtungen dienen zur Abdichtung des Steckbereiches der Signalkontakte (Kombination **FWD...** mit High Density D-Sub Steckverbindern **...-2429**) und werden im Stiftstecker montiert (siehe Zeichnung). Sie sind auch mit Standard D-Sub Steckverbindern verwendbar.*



Order Number Index

Bestellnummern - Index

C

CT09-15P	8
CT09-15P1	10
CT09-15P1-1432	21
CT09-15P1-1779	22
CT09-15P5L222	12
CT09-15P5-L228	12
CT09-15P5-L229	12
CT09-15S	9
CT09-15S1	11
CT09-15S5-L222	13
CT09-15S5-L228	13
CT09-15S5-L229	13
CT15-26P	8
CT15-26P1	10
CT15-26P5L222	12
CT15-26P5-L228	12
CT15-26P5-L229	12
CT15-26S	9
CT15-26S1	11
CT15-26S5-L222	13
CT15-26S5-L228	13
CT15-26S5-L229	13
CT25-44P	8
CT25-44P1	10
CT25-44P5L222	12
CT25-44P5-L228	12
CT25-44P5-L229	12
CT25-44S	9
CT25-44S1	11
CT25-44S5-L222	13
CT25-44S5-L228	13
CT25-44S5-L229	13
CT37-62P	8
CT37-62P1	10
CT37-62P5L222	12
CT37-62P5-L228	12
CT37-62P5-L229	12
CT37-62S	9
CT37-62S1	11
CT37-62S5-L222	13
CT37-62S5-L228	13
CT37-62S5-L229	13
CT50-78P	8
CT50-78P1	10
CT50-78P7	17
CT50-78S	9
CT50-78S1	11
CT50-78S5-L228	13
CT50-78S5-L229	13
CT50-78S7	18

F

F1043-1F	34
F1043-2F	34
F1043-3F	34
F1043-4F	34
F1043-5F	34
F1839	28
FAW1	27
FAW1HPS...	24
FAW1HPSR	24
FAW1HSPR	24
FAW1PS	24
FAW1PS...	24
FAW1SP	24
FAW2	27
FAW3	27
FAW4	27
FAW5W1SP...	24
F-GSCH1/5-K834	34
F-GSCH1/5-K835	34
FK22PL-02V...	20
FK22PL-08V...	20
FK22PL-13V...	20
FK22SL-02V...	20
FK22SL-08V...	20
FK22SL-08V_0100	20
FK22SL-13V...	20
FL09-15P7	17
FL09-15S7	18
FL15-26P7	17
FL15-26S7	18
FL25-44P7	17
FL25-44S7	18
FL37-62P7	17
FL37-62S7	18
FLT09-15P7	21
FWDFM09-15P	34
FWDFM09-15P-K1444	32
FWDFM09-15S-K1444	32
FWDFM15-26P-K1444	32
FWDFM15-26S-K1444	32
FWDFM25-44P-K1444	32
FWDFM25-44S-K1444	32
FWDFM37-62P-K1444	32
FWDFM37-62S-K1444	32
FWDFM50-78P-K1444	32
FWDFM50-78S-K1444	32
FWDRM09-15P	34
FWDRM9-15P1-K1676	33
FWDRM9-15P-K1444	32
FWDRM9-15S1-K1676	33
FWDRM9-15S-K1444	32
FWDRM15-26P1-K1676	33

FWDRM15-26P-K1444	32
FWDRM15-26S1-K1676	33
FWDRM15-26S-K1444	32
FWDRM25-44P1-K1676	33
FWDRM25-44P-K1444	32
FWDRM25-44S1-K1676	33
FWDRM25-44S-K1444	32
FWDRM37-62P1-K1676	33
FWDRM37-62P-K1444	32
FWDRM37-62S1-K1676	33
FWDRM37-62S-K1444	32
FWDRM50-78P1-K1676	33
FWDRM50-78P-K1444	32
FWDRM50-78S1-K1676	33
FWDRM50-78S-K1444	32

M

M22520/2-01	29
M22520/2-06	29
M22520/2-09	29
M39029/57-354	20
M39029/58-360	20
M81969/1-04	29
M81969/8-01	29
M81969/8-02	29
M81969/14-01	29

P

P110-01V...	19
P110-06V...	19

S

S110-01V...	19
S110-06V...	19

Mouser Electronics

Authorized Distributor

Click to View Pricing, Inventory, Delivery & Lifecycle Information:

[Molex:](#)

[FL37-62P7](#)



Компания «ЭлектроПласт» предлагает заключение долгосрочных отношений при поставках импортных электронных компонентов на взаимовыгодных условиях!

Наши преимущества:

- Оперативные поставки широкого спектра электронных компонентов отечественного и импортного производства напрямую от производителей и с крупнейших мировых складов;
- Поставка более 17-ти миллионов наименований электронных компонентов;
- Поставка сложных, дефицитных, либо снятых с производства позиций;
- Оперативные сроки поставки под заказ (от 5 рабочих дней);
- Экспресс доставка в любую точку России;
- Техническая поддержка проекта, помощь в подборе аналогов, поставка прототипов;
- Система менеджмента качества сертифицирована по Международному стандарту ISO 9001;
- Лицензия ФСБ на осуществление работ с использованием сведений, составляющих государственную тайну;
- Поставка специализированных компонентов (Xilinx, Altera, Analog Devices, Intersil, Interpoint, Microsemi, Aeroflex, Peregrine, Syfer, Eurofarad, Texas Instrument, Miteq, Cobham, E2V, MA-COM, Hittite, Mini-Circuits, General Dynamics и др.);

Помимо этого, одним из направлений компании «ЭлектроПласт» является направление «Источники питания». Мы предлагаем Вам помощь Конструкторского отдела:

- Подбор оптимального решения, техническое обоснование при выборе компонента;
- Подбор аналогов;
- Консультации по применению компонента;
- Поставка образцов и прототипов;
- Техническая поддержка проекта;
- Защита от снятия компонента с производства.



Как с нами связаться

Телефон: 8 (812) 309 58 32 (многоканальный)

Факс: 8 (812) 320-02-42

Электронная почта: org@eplast1.ru

Адрес: 198099, г. Санкт-Петербург, ул. Калинина, дом 2, корпус 4, литера А.