

# RSB, 5 mm Lead Spacing, 50 – 630 VDC (Automotive Grade)

## Overview

The RSB is constructed of metallized polyester film (stacked technology) with radial leads of tinned wire. Radial leads are electrically welded to the contact metal layer on the ends of the capacitor winding. The capacitor is encapsulated with thermosetting resin in a box of material meeting the UL 94 V-0 requirements.

Automotive grade devices meet the demanding Automotive Electronics Council's AEC-Q200 qualification requirements.

## Applications

Typical applications include high performance, high temperature, blocking, coupling, decoupling for a signal from DC to high frequency, pulse, logic and timing circuit, lamp capacitor for electronic compact lamps, inverter for LCD monitors, and automotive DC motor suppression. Not suitable for across-the-line application (see Suppressor Capacitors).

## Benefits

- Voltage range: 50 – 630 VDC
- Capacitance range: 0.001 – 4.7  $\mu$ F
- Lead spacing: 5 mm
- Capacitance tolerance:  $\pm$ 20%,  $\pm$ 10% standard,  $\pm$ 5% on request
- Climatic category: 55/125/56
- Operating temperature range of  $-55^{\circ}\text{C}$  to  $+125^{\circ}\text{C}$
- RoHS Compliant and lead-free terminations
- Tape and reel packaging in accordance with IEC 60286-2
- Self-healing
- Automotive grade (AEC-Q200)

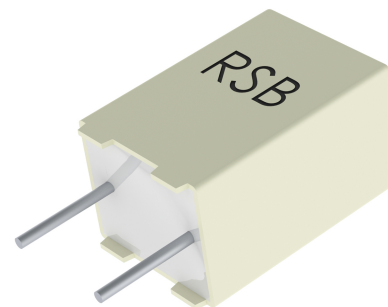

## Part Number System

RSB	D	C	3100	AA	00	J
Series	Rated Voltage (VDC)	Length (mm)	Capacitance Code (pF)	Packaging	Internal Use	Capacitance Tolerance
Metallized Polyester	C = 50 D = 63 E = 100 I = 250 M = 400 W = 500 P = 630	C = 5.0	The last three digits represent significant figures. First digit specifies the number of zeros to be added.	See Ordering Options Table	30 50 60 70	J = $\pm$ 5% K = $\pm$ 10% M = $\pm$ 20%

## Ordering Options Table

Lead Spacing Nominal (mm)	Type of Leads and Packaging	LL Lead Length (mm)	Lead and Packaging Code
5	<b>Standard Lead and Packaging Options</b>		
	Bulk (Bag) – Short Leads	4 +1.5/-0	AA
	Ammo Pack	$H_0=18.5 \pm 0.5$	DQ
	<b>Other Lead and Packaging Options</b>		
	Tape & Reel (Standard Reel $\varnothing$ 355 mm)	$H_0 = 18.5 \pm 0.5$	CK
	Bulk (Bag) – Short Leads	2.7 +0.5/-0	JA
	Bulk (Bag) – Short Leads	3.5 +0.5/-0	JB
	Bulk (Bag) – Short Leads	10 $\pm$ 1	JC
	Bulk (Bag) – Short Leads	3.2 +0.3/-0.2	JH
Bulk (Bag) – Long Leads	17 +1/-2	Z3	

## Dimensions – Millimeters

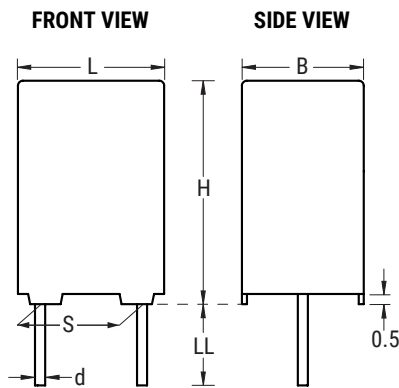

S		B		H		L		d	
Nominal	Tolerance	Nominal	Tolerance	Nominal	Tolerance	Nominal	Tolerance	Nominal	Tolerance
5.0	$\pm 0.4$	2.5	+0.1/-0.5	6.5	+0.1/-0.5	7.2	+0.2/-0.5	0.5	$\pm 0.05$
5.0	$\pm 0.4$	3.5	+0.1/-0.5	7.5	+0.1/-0.5	7.2	+0.2/-0.5	0.5	$\pm 0.05$
5.0	$\pm 0.4$	4.5	+0.1/-0.5	9.5	+0.1/-0.5	7.2	+0.3/-0.5	0.5	$\pm 0.05$
5.0	$\pm 0.4$	5.0	+0.1/-0.5	10.0	+0.1/-0.5	7.2	+0.3/-0.5	0.5	$\pm 0.05$
5.0	$\pm 0.4$	6.0	+0.1/-0.5	11.0	+0.1/-0.5	7.2	+0.3/-0.5	0.5	$\pm 0.05$
5.0	$\pm 0.4$	7.2	+0.1/-0.5	13.0	+0.1/-0.5	7.2	+0.3/-0.5	0.5	$\pm 0.05$

**Note: See Ordering Options Table for lead length (LL/H<sub>0</sub>) options.**

## Performance Characteristics

Dielectric	Polyester film (polyethylene terephthalate)						
Plates	Metal layer deposited by evaporation under vacuum						
Winding	Non-inductive type						
Leads	Tinned wire						
Protection	Plastic case, thermosetting resin filled. Box material is solvent resistant and flame retardant according to UL94.						
Related Documents	IEC 60384-2						
Rated Voltage $V_R$ (VDC)	50	63	100	250	400	500	630
Rated Voltage $V_R$ (VAC)	30	40	63	160	200	220	220
Capacitance Range ( $\mu\text{F}$ )	2.2	0.1 – 4.7	0.0047 – 0.47	0.001 – 0.15	0.001 – 0.047	0.001 – 0.015	0.001 – 0.01
Capacitance Values	E6 series (IEC 60063) measured at 1 kHz and $+20\pm 1^\circ\text{C}$						
Capacitance Tolerance	$\pm 5\%$ on request, $\pm 10\%$ , $\pm 20\%$						
Operating Temperature Range	$-55^\circ\text{C}$ to $125^\circ\text{C}$						
Rated Temperature $T_R$	$+85^\circ\text{C}$						
Voltage Derating	Above $+85^\circ\text{C}$ DC and AC voltage derating is $1.25\%/^\circ\text{C}$						
Climatic Category	55/125/56 IEC 60068-1						
Storage Conditions	Storage time: $\leq 24$ months from the date marked on the label package						
	Average relative humidity per year $\leq 70\%$						
	RH $\leq 85\%$ for 30 days randomly distributed throughout the year						
	Dew is absent						
	Temperature: $-40$ to $80^\circ\text{C}$ (see "Maximum Humidity in Storage Conditions" graph below)						
Test Voltage	$1.6 \times V_R$ VDC for 2 seconds (between terminations) at $+25^\circ\text{C} \pm 5^\circ\text{C}$						
Capacitance Drift	Maximum 3% after a 2 year storage period at a temperature of $+10^\circ\text{C}$ to $+40^\circ\text{C}$ and a relative humidity of 40% to 60%						
Reliability (Reference IEC 61709)	Operational life $>200,000$ hours						
	Failure rate $\leq 1$ FIT, $T = +40^\circ\text{C}$ , $V = 0.5 \times V_R$						
Maximum Pulse Steepness	Failure criteria: open or short circuit, cap. change $> 10\%$ , DF 2 times the catalog limits, IR $< 0.005 \times$ initial limit						
Maximum Pulse Steepness	dV/dt according to Table 1. For peak to peak voltages lower than rated voltage ( $V_{pp} < V_R$ ), the specified dv/dt can be multiplied by the factor $V_R/V_{pp}$						
Temperature Coefficient	$+400 (\pm 200)$ ppm/ $^\circ\text{C}$ at 1 kHz						
Self Inductance (Lead Length $\sim 2$ mm)	Approximately 7 nH. Maximum 1nH per 1 mm lead and capacitor length.						

## Performance Characteristics cont.

Dissipation Factor $\tan\delta$	Maximum Values at 25°C ±5°C			
	Frequency	C ≤ 0.1 μF	0.1 μF < 2.2 μF	C > 2.2 μF
	1 kHz	0.80%	0.80%	0.80%
	10 kHz	1.20%	1.20%	1.50%
100 kHz	2.50%	-	-	

Insulation Resistance	Measured at +25°C ±5°C, according to IEC 60384-2			
	Minimum Values Between Terminals			
	Voltage Charge/Time	C ≤ 0.33 μF	0.33 μF < C ≤ 1.0 μF	C > 1.0 μF
	50 VDC for V <sub>R</sub> ≤ 100 VDC 1 minute	≥ 15,000 MΩ	≥ 5,000 MΩ · μF	≥ 1,000 MΩ · μF
100 VDC for V <sub>R</sub> > 100 VDC 1 minute	≥ 30,000 MΩ			

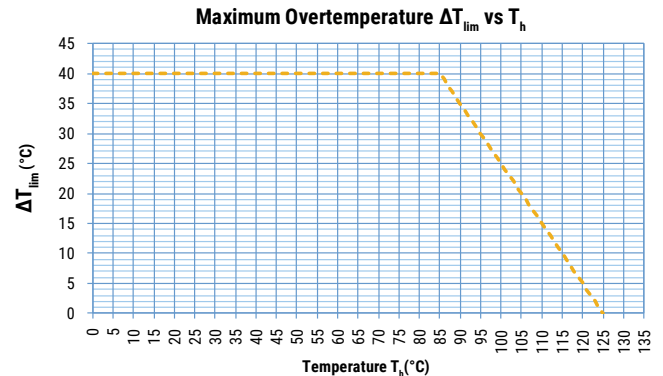

$T_h$  is the maximum ambient temperature surrounding the capacitor or hottest contact point (e.g. tracks), whichever is higher, in the worst operation conditions in °C.

## Qualification

Automotive grade products meet or exceed the requirements outlined by the Automotive Electronics Council. Details regarding test methods and conditions are referenced in document AEC-Q200, Stress Test Qualification for Passive Components. For additional information regarding the Automotive Electronics Council and AEC-Q200, please visit their website at [www.aecouncil.com](http://www.aecouncil.com).

## Maximum Voltage ( $V_{rms}$ ) vs. Frequency (Sinusoidal Waveform/ $T_h \leq 40^\circ\text{C}$ )

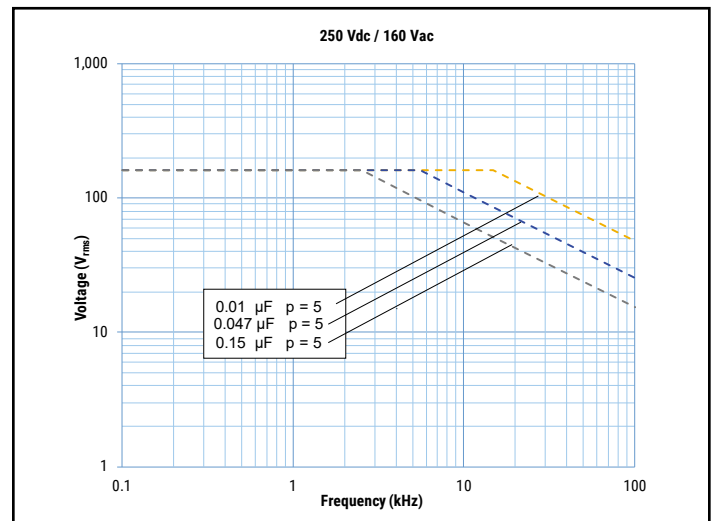
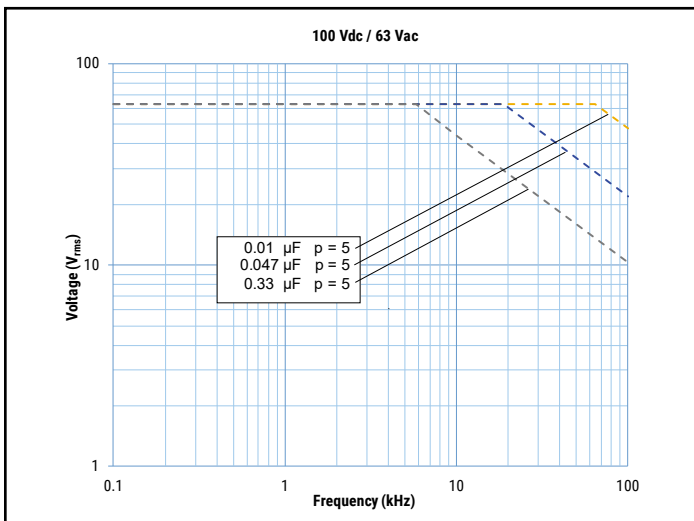
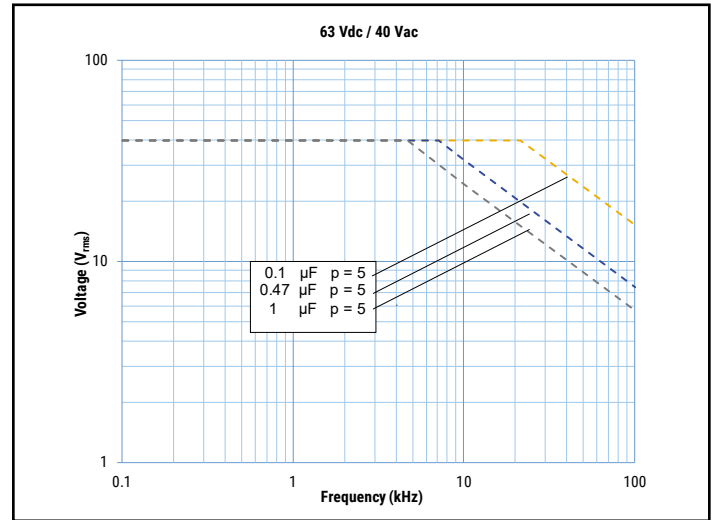
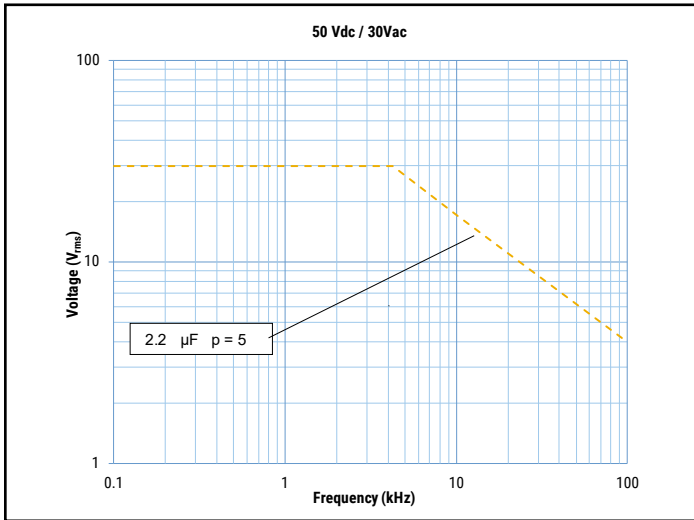

## Maximum Voltage ( $V_{rms}$ ) vs. Frequency (Sinusoidal Waveform/ $T_h \leq 40^\circ C$ ) cont.

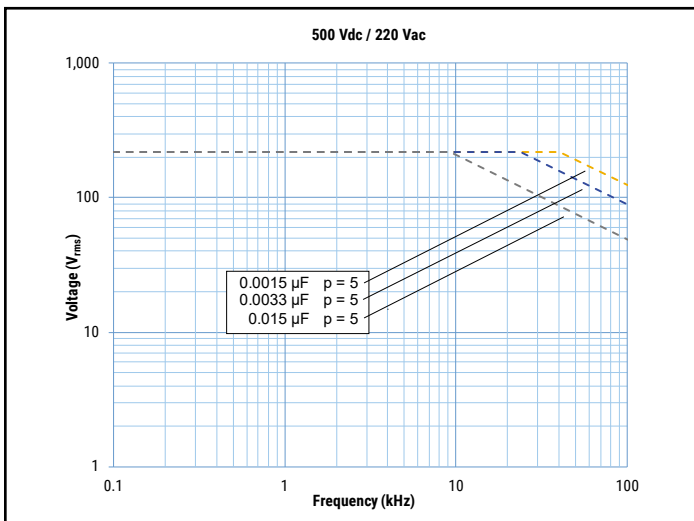
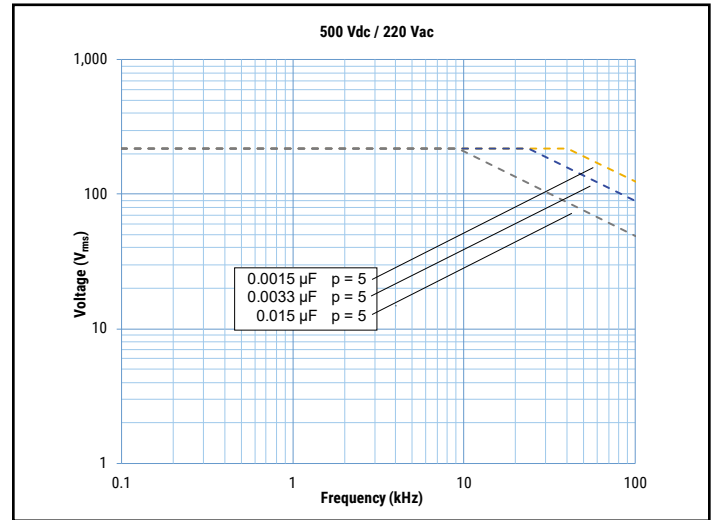
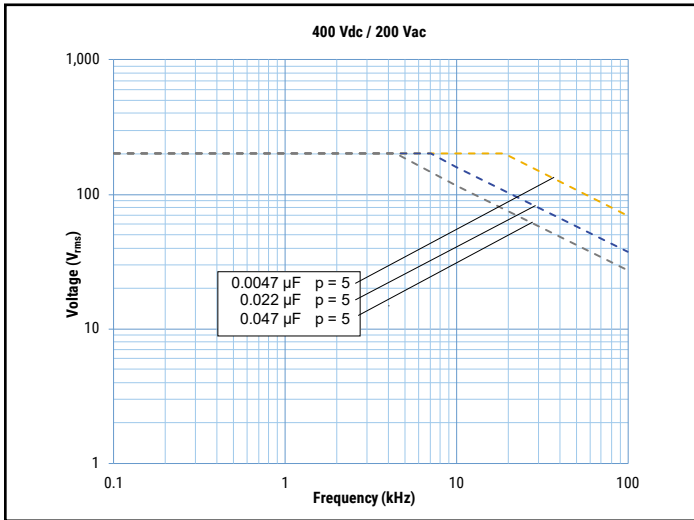

## Maximum Current ( $I_{rms}$ ) vs. Frequency (Sinusoidal Waveform/ $T_h \leq 40^\circ\text{C}$ )

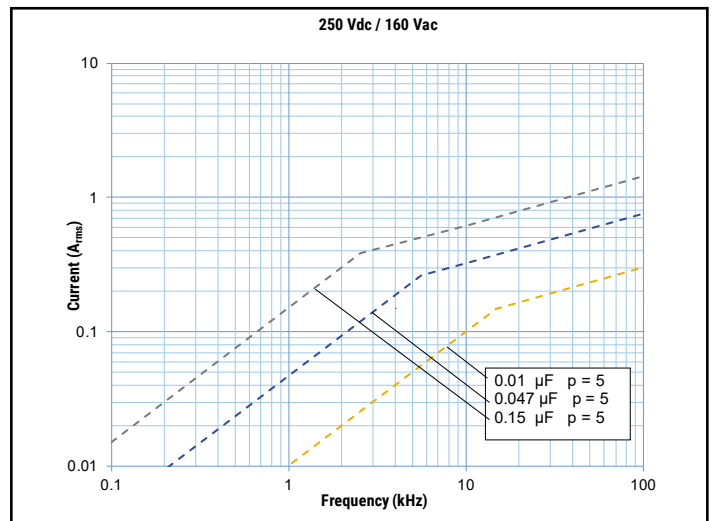
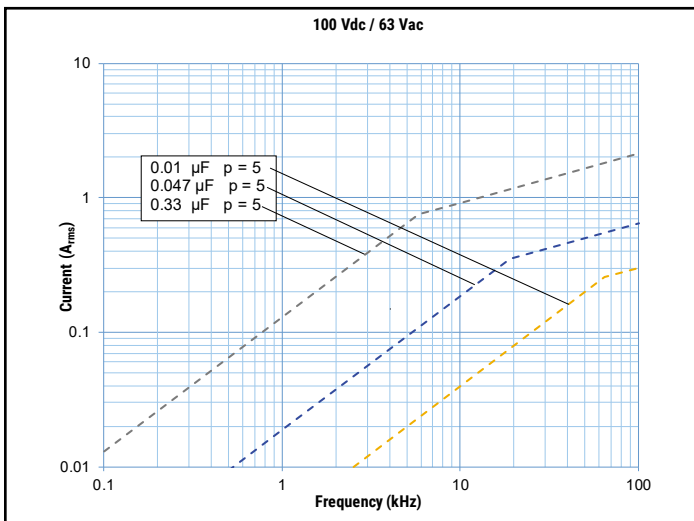
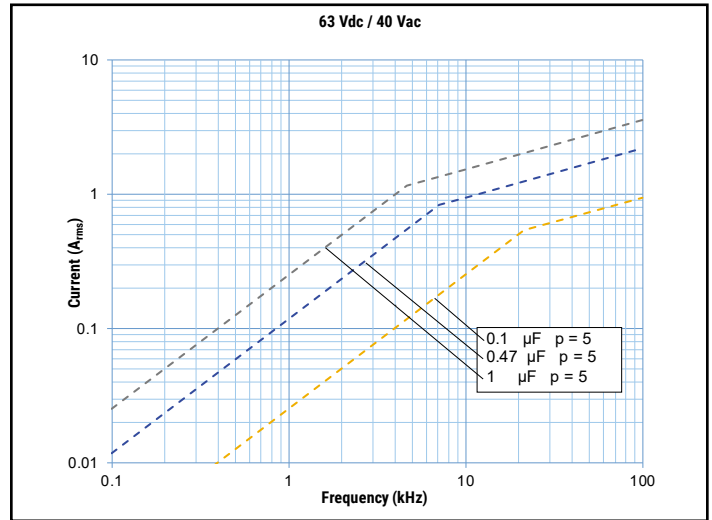
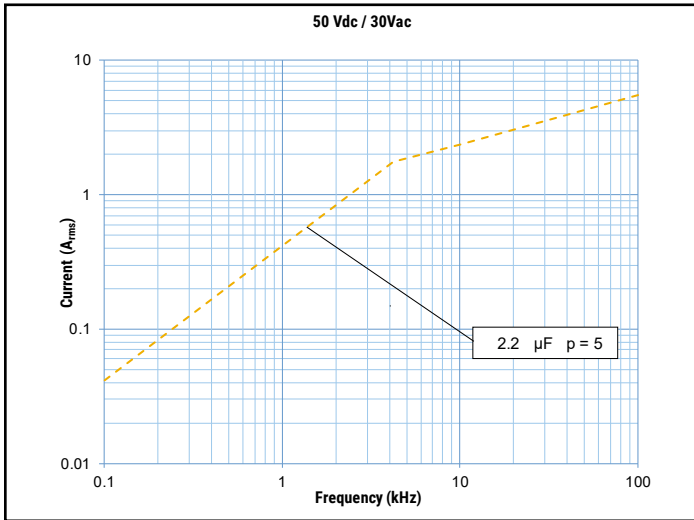

## Maximum Current ( $I_{rms}$ ) vs. Frequency (Sinusoidal Waveform/ $T_h \leq 40^\circ\text{C}$ ) cont.

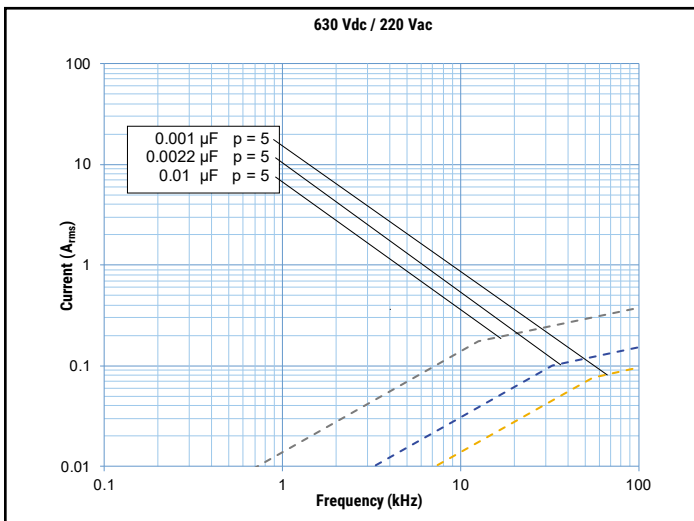
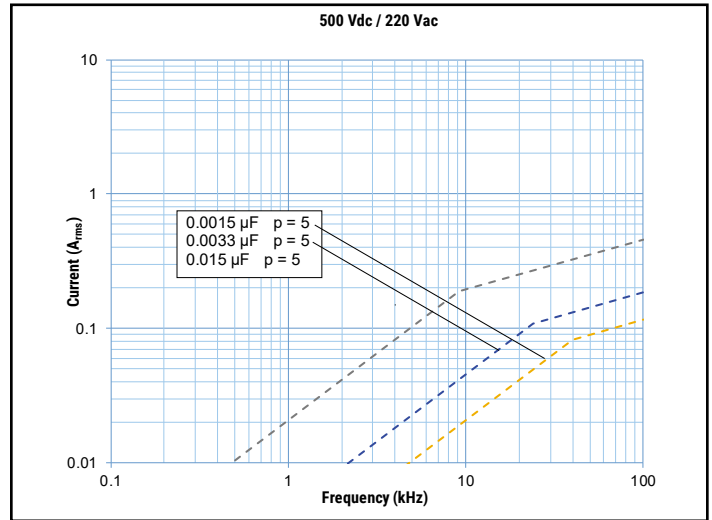
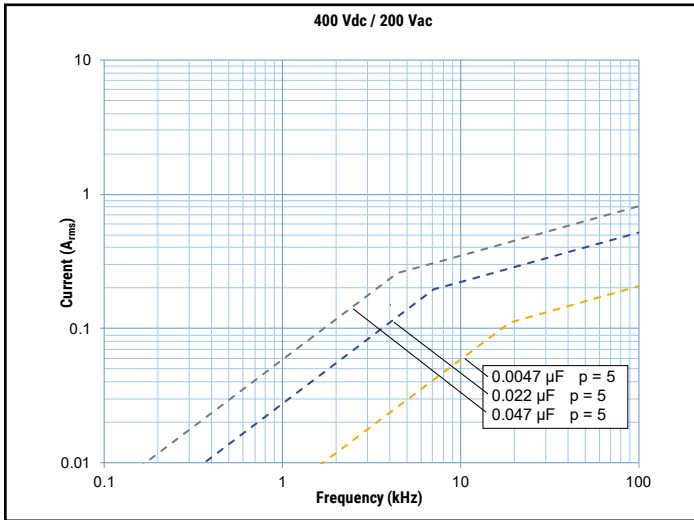



## Environmental Test Data

Damp Heat, Steady State Test	Test Conditions:		Performances
	Temperature: Relative humidity (RH): Test duration:	+40°C ±2°C 93% ±2% 56 days	Δ C/C  ≤ 5%, Δ tanδ ≤ 0.005 at 1 kHz IR after test ≥ 50% of initial limit
Endurance Test	Test Conditions		Performances
	Temperature: Voltage applied: Test duration:	+125°C ±2°C 1.25 x V <sub>C</sub> 2,000 hours	Δ C/C  ≤ 5%, Δ tanδ ≤ 0.003 at 10 kHz for C ≤ 1μF Δ tanδ ≤ 0.002 at 1 kHz for C > 1μF IR after test ≥ 50% of initial limit
Resistance to Soldering Heat Test	Test Conditions		Performances
	Solder bath temperature: Dipping time (with heat screen):	260°C ±5°C 10 seconds ±1 second	Δ C/C  ≤ 2%, Δ tanδ ≤ 0.003 at 10 kHz for C ≤ 1μF Δ tanδ ≤ 0.002 at 1 kHz for C > 1μF IR after test ≥ initial limit

## Environmental Compliance

All KEMET MKT capacitors are RoHS Compliant.



**Table 1 – Ratings & Part Number Reference**

VDC	VAC	Capacitance Value (µF)	Dimensions in mm			Lead Spacing	dV/dt (V/µs)	Maximum K <sub>0</sub> (V <sup>2</sup> /µs)	New KEMET Part Number	Legacy Part Number
			B	H	L					
50	30	2.2	6.0	11.0	7.2	5.0	200	20,000	SBCC4220(1)10(2)	RSBCC4220(1)10(2)
63	40	0.10	2.5	6.5	7.2	5.0	250	31,500	SBDC3100(1)00(2)	RSBDC3100(1)00(2)
63	40	0.15	2.5	6.5	7.2	5.0	250	31,500	SBDC3150(1)00(2)	RSBDC3150(1)00(2)
63	40	0.22	2.5	6.5	7.2	5.0	250	31,500	SBDC3220(1)10(2)	RSBDC3220(1)10(2)
63	40	0.33	3.5	7.5	7.2	5.0	250	31,500	SBDC3330(1)00(2)	RSBDC3330(1)00(2)
63	40	0.47	3.5	7.5	7.2	5.0	250	31,500	SBDC3470(1)10(2)	RSBDC3470(1)10(2)
63	40	0.68	4.5	9.5	7.2	5.0	250	31,500	SBDC3680(1)10(2)	RSBDC3680(1)10(2)
63	40	1.0	5.0	10.0	7.2	5.0	250	31,500	SBDC4100(1)10(2)	RSBDC4100(1)10(2)
63	40	1.5	6.0	11.0	7.2	5.0	250	31,500	SBDC4150(1)10(2)	RSBDC4150(1)10(2)
63	40	2.2	6.0	11.0	7.2	5.0	100	12,600	SBDC4220(1)20(2)	RSBDC4220(1)20(2)
63	40	3.3	7.2	13.0	7.2	5.0	100	12,600	SBDC4330(1)20(2)	RSBDC4330(1)20(2)
<b>63</b>	<b>40</b>	<b>4.7</b>	<b>7.2</b>	<b>13.0</b>	<b>7.2</b>	<b>5.0</b>	<b>100</b>	<b>12,600</b>	<b>SBDC4470(1)20(3)</b>	<b>RSBDC4470(1)20(3)</b>
100	63	0.0047	2.5	6.5	7.2	5.0	300	60,000	SBEC1470(1)00(2)	RSBEC1470(1)00(2)
100	63	0.0068	2.5	6.5	7.2	5.0	300	60,000	SBEC1680(1)00(2)	RSBEC1680(1)00(2)
100	63	0.010	2.5	6.5	7.2	5.0	300	60,000	SBEC2100(1)00(2)	RSBEC2100(1)00(2)
100	63	0.015	2.5	6.5	7.2	5.0	300	60,000	SBEC2150(1)00(2)	RSBEC2150(1)00(2)
100	63	0.022	2.5	6.5	7.2	5.0	300	60,000	SBEC2220(1)00(2)	RSBEC2220(1)00(2)
100	63	0.033	2.5	6.5	7.2	5.0	300	60,000	SBEC2330(1)00(2)	RSBEC2330(1)00(2)
100	63	0.047	2.5	6.5	7.2	5.0	300	60,000	SBEC2470(1)00(2)	RSBEC2470(1)00(2)
100	63	0.07	2.5	6.5	7.2	5.0	300	60,000	SBEC2680(1)10(2)	RSBEC2680(1)10(2)
100	63	0.10	3.5	7.5	7.2	5.0	300	60,000	SBEC3100(1)00(2)	RSBEC3100(1)00(2)
100	63	0.15	4.5	9.5	7.2	5.0	300	60,000	SBEC3150(1)00(2)	RSBEC3150(1)00(2)
100	63	0.22	5.0	10.0	7.2	5.0	300	60,000	SBEC3220(1)00(2)	RSBEC3220(1)00(2)
100	63	0.33	6.0	11.0	7.2	5.0	300	60,000	SBEC3330(1)00(2)	RSBEC3330(1)00(2)
100	63	0.47	6.0	11.0	7.2	5.0	300	60,000	SBEC3470(1)10(2)	RSBEC3470(1)10(2)
250	160	0.0010	2.5	6.5	7.2	5.0	400	200,000	SBIC1100(1)00(2)	RSBIC1100(1)00(2)
250	160	0.0015	2.5	6.5	7.2	5.0	400	200,000	SBIC1150(1)00(2)	RSBIC1150(1)00(2)
250	160	0.0022	2.5	6.5	7.2	5.0	400	200,000	SBIC1220(1)00(2)	RSBIC1220(1)00(2)
250	160	0.0033	2.5	6.5	7.2	5.0	400	200,000	SBIC1330(1)00(2)	RSBIC1330(1)00(2)
250	160	0.0047	2.5	6.5	7.2	5.0	400	200,000	SBIC1470(1)00(2)	RSBIC1470(1)00(2)
250	160	0.0068	2.5	6.5	7.2	5.0	400	200,000	SBIC1680(1)00(2)	RSBIC1680(1)00(2)
250	160	0.010	2.5	6.5	7.2	5.0	400	200,000	SBIC2100(1)00(2)	RSBIC2100(1)00(2)
250	160	0.015	2.5	6.5	7.2	5.0	400	200,000	SBIC2150(1)00(2)	RSBIC2150(1)00(2)
250	160	0.022	3.5	7.5	7.2	5.0	400	200,000	SBIC2220(1)00(2)	RSBIC2220(1)00(2)
250	160	0.033	3.5	7.5	7.2	5.0	400	200,000	SBIC2330(1)00(2)	RSBIC2330(1)00(2)
VDC	VAC	Capacitance Value (µF)	B (mm)	H (mm)	L (mm)	Lead Spacing	dV/dt (V/µs)	Max K <sub>0</sub> (V <sup>2</sup> /µs)	New KEMET Part Number	Legacy Part Number

(1) Insert lead and packaging code. See Ordering Options Table for available options.

(2) K = ±10%, M = ±20%, J = ±5% on request.

(3) M = ±20% (only available tolerance).

**Table 1 – Ratings & Part Number Reference cont.**

VDC	VAC	Capacitance Value (µF)	Dimensions in mm			Lead Spacing	dV/dt (V/µs)	Maximum K <sub>0</sub> (V <sup>2</sup> /µs)	New KEMET Part Number	Legacy Part Number
			B	H	L					
250	160	0.047	4.5	9.5	7.2	5.0	400	200,000	SBIC2470(1)00(2)	RSBIC2470(1)00(2)
250	160	0.068	4.5	9.5	7.2	5.0	400	200,000	SBIC2680(1)00(2)	RSBIC2680(1)00(2)
250	160	0.10	5.0	10.0	7.2	5.0	400	200,000	SBIC3100(1)00(2)	RSBIC3100(1)00(2)
250	160	0.15	6.0	11.0	7.2	5.0	400	200,000	SBIC3150(1)00(2)	RSBIC3150(1)00(2)
400	200	0.0010	2.5	6.5	7.2	5.0	600	480,000	SBMC1100(1)00(2)	RSBMC1100(1)00(2)
400	200	0.0015	2.5	6.5	7.2	5.0	600	480,000	SBMC1150(1)00(2)	RSBMC1150(1)00(2)
400	200	0.0022	2.5	6.5	7.2	5.0	600	480,000	SBMC1220(1)00(2)	RSBMC1220(1)00(2)
400	200	0.0033	2.5	6.5	7.2	5.0	600	480,000	SBMC1330(1)00(2)	RSBMC1330(1)00(2)
400	200	0.0047	2.5	6.5	7.2	5.0	600	480,000	SBMC1470(1)00(2)	RSBMC1470(1)00(2)
400	200	0.0068	3.5	7.5	7.2	5.0	600	480,000	SBMC1680(1)00(2)	RSBMC1680(1)00(2)
400	200	0.010	3.5	7.5	7.2	5.0	600	480,000	SBMC2100(1)00(2)	RSBMC2100(1)00(2)
400	200	0.015	3.5	7.5	7.2	5.0	600	480,000	SBMC2150(1)00(2)	RSBMC2150(1)00(2)
400	200	0.022	4.5	9.5	7.2	5.0	600	480,000	SBMC2220(1)00(2)	RSBMC2220(1)00(2)
400	200	0.033	5.0	10.0	7.2	5.0	600	480,000	SBMC2330(1)00(2)	RSBMC2330(1)00(2)
400	200	0.047	6.0	11.0	7.2	5.0	600	480,000	SBMC2470(1)00(2)	RSBMC2470(1)00(2)
500	220	0.0010	2.5	6.5	7.2	5.0	700	700,000	SBWC1100(1)00(2)	RSBWC1100(1)00(2)
500	220	0.0015	2.5	6.5	7.2	5.0	700	700,000	SBWC1150(1)00(2)	RSBWC1150(1)00(2)
500	220	0.0022	3.5	7.5	7.2	5.0	700	700,000	SBWC1220(1)00(2)	RSBWC1220(1)00(2)
500	220	0.0033	3.5	7.5	7.2	5.0	700	700,000	SBWC1330(1)00(2)	RSBWC1330(1)00(2)
500	220	0.0047	3.5	7.5	7.2	5.0	700	700,000	SBWC1470(1)00(2)	RSBWC1470(1)00(2)
500	220	0.0068	4.5	9.5	7.2	5.0	700	700,000	SBWC1680(1)00(2)	RSBWC1680(1)00(2)
500	220	0.010	5.0	10.0	7.2	5.0	700	700,000	SBWC2100(1)00(2)	RSBWC2100(1)00(2)
500	220	0.015	6.0	11.0	7.2	5.0	700	700,000	SBWC2150(1)00(2)	RSBWC2150(1)00(2)
630	220	0.0010	2.5	6.5	7.2	5.0	800	1,008,000	SBPC1100(1)00(2)	RSBPC1100(1)00(2)
630	220	0.0015	3.5	7.5	7.2	5.0	800	1,008,000	SBPC1150(1)00(2)	RSBPC1150(1)00(2)
630	220	0.0022	3.5	7.5	7.2	5.0	800	1,008,000	SBPC1220(1)00(2)	RSBPC1220(1)00(2)
630	220	0.0033	4.5	9.5	7.2	5.0	800	1,008,000	SBPC1330(1)00(2)	RSBPC1330(1)00(2)
630	220	0.0047	4.5	9.5	7.2	5.0	800	1,008,000	SBPC1470(1)00(2)	RSBPC1470(1)00(2)
630	220	0.0068	5.0	10.0	7.2	5.0	800	1,008,000	SBPC1680(1)00(2)	RSBPC1680(1)00(2)
630	220	0.010	6.0	11.0	7.2	5.0	800	1,008,000	SBPC2100(1)00(2)	RSBPC2100(1)00(2)
VDC	VAC	Capacitance Value (µF)	B (mm)	H (mm)	L (mm)	Lead Spacing	dV/dt (V/µs)	Max K <sub>0</sub> (V <sup>2</sup> /µs)	New KEMET Part Number	Legacy Part Number

(1) Insert lead and packaging code. See Ordering Options Table for available options.

(2) K = ±10%, M = ±20%, J = ±5% on request.

(3) M = ±20% (only available tolerance).

## Soldering Process

The implementation of the RoHS directive has resulted in the selection of SnAgCu (SAC) alloys or SnCu alloys as primary solder. This has increased the liquidus temperature from that of 183°C for SnPb eutectic alloy to 217 – 221°C for the new alloys. As a result, the heat stress to the components, even in wave soldering, has increased considerably due to higher pre-heat and wave temperatures. Polypropylene capacitors are especially sensitive to heat (the melting point of polypropylene is 160 – 170°C). Wave soldering can be destructive, especially for mechanically small polypropylene capacitors (with lead spacing of 5 to 15 mm), and great care has to be taken during soldering. The recommended solder profiles from KEMET should be used. Please consult KEMET with any questions. In general, the wave soldering curve from IEC Publication 61760–1 Edition 2, serves as a solid guideline for successful soldering. Please see Figure 1.

Reflow soldering is not recommended for through-hole film capacitors. Exposing capacitors to a soldering profile in excess of the above the recommended limits may result to degradation or permanent damage to the capacitors.

Do not place the polypropylene capacitor through an adhesive curing oven to cure resin for surface mount components. Insert through-hole parts after the curing of surface mount parts. Consult KEMET to discuss the actual temperature profile in the oven, if through-hole components must pass through the adhesive curing process. A maximum two soldering cycles is recommended. Please allow time for the capacitor surface temperature to return to a normal temperature before the second soldering cycle.

### Manual Soldering Recommendations

Following is the recommendation for manual soldering with a soldering iron.

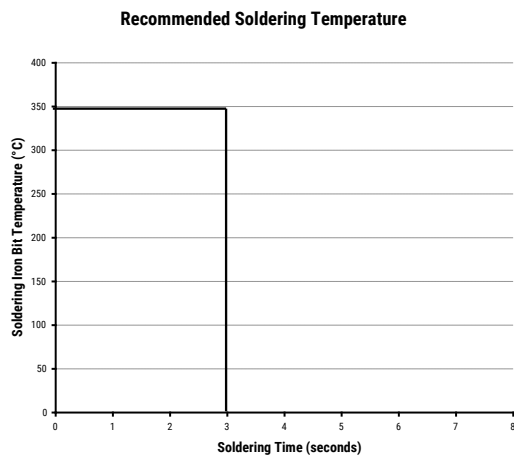

The soldering iron tip temperature should be set at 350°C (+10°C maximum) with the soldering duration not to exceed more than 3 seconds.

### Wave Soldering Recommendations

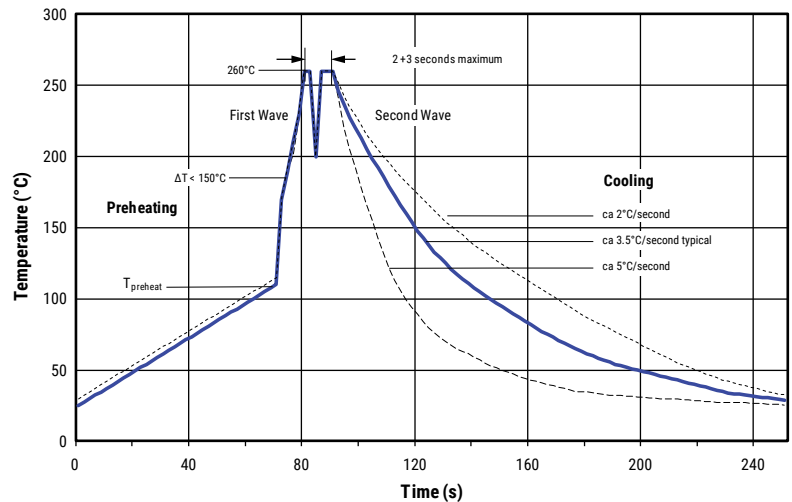

## Soldering Process cont.

### Wave Soldering Recommendations cont.

1. The table indicates the maximum set-up temperature of the soldering process  
 Figure 1.

Dielectric Film Material	Maximum Preheat Temperature		Maximum Peak Soldering Temperature	
	Capacitor Pitch ≤ 15 mm	Capacitor Pitch > 15 mm	Capacitor Pitch ≤ 15 mm	Capacitor Pitch > 15 mm
Polyester	130°C	130°C	270°C	270°C
Polypropylene	110°C	130°C	260°C	270°C
Paper	130°C	140°C	270°C	270°C
Polyphenylene Sulphide	150°C	160°C	270°C	270°C

2. The maximum temperature measured inside the capacitor:

Set the temperature so that inside the element the maximum temperature is below the limit:

Dielectric Film Material	Maximum temperature measured inside the element
Polyester	160°C
Polypropylene	110°C
Paper	160°C
Polyphenylene Sulphide	160°C

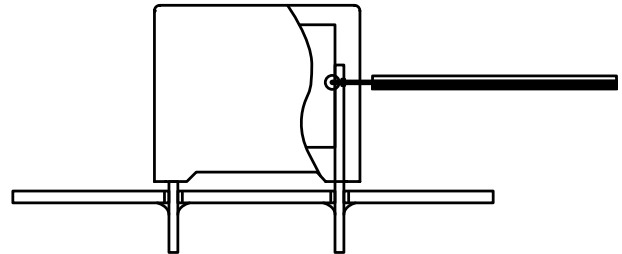

*Temperature monitored inside the capacitor.*

### Selective Soldering Recommendations

Selective dip soldering is a variation of reflow soldering. In this method, the printed circuit board with through-hole components to be soldered is preheated and transported over the solder bath as in normal flow soldering without touching the solder. When the board is over the bath, it is stopped and pre-designed solder pots are lifted from the bath with molten solder only at the places of the selected components, and pressed against the lower surface of the board to solder the components.

The temperature profile for selective soldering is similar to the double wave flow soldering outlined in this document, **however, instead of two baths, there is only one bath with a time from 3 to 10 seconds.** In selective soldering, the risk of overheating is greater than in double wave flow soldering, and great care must be taken so that the parts are not overheated.

## Construction

Stacked

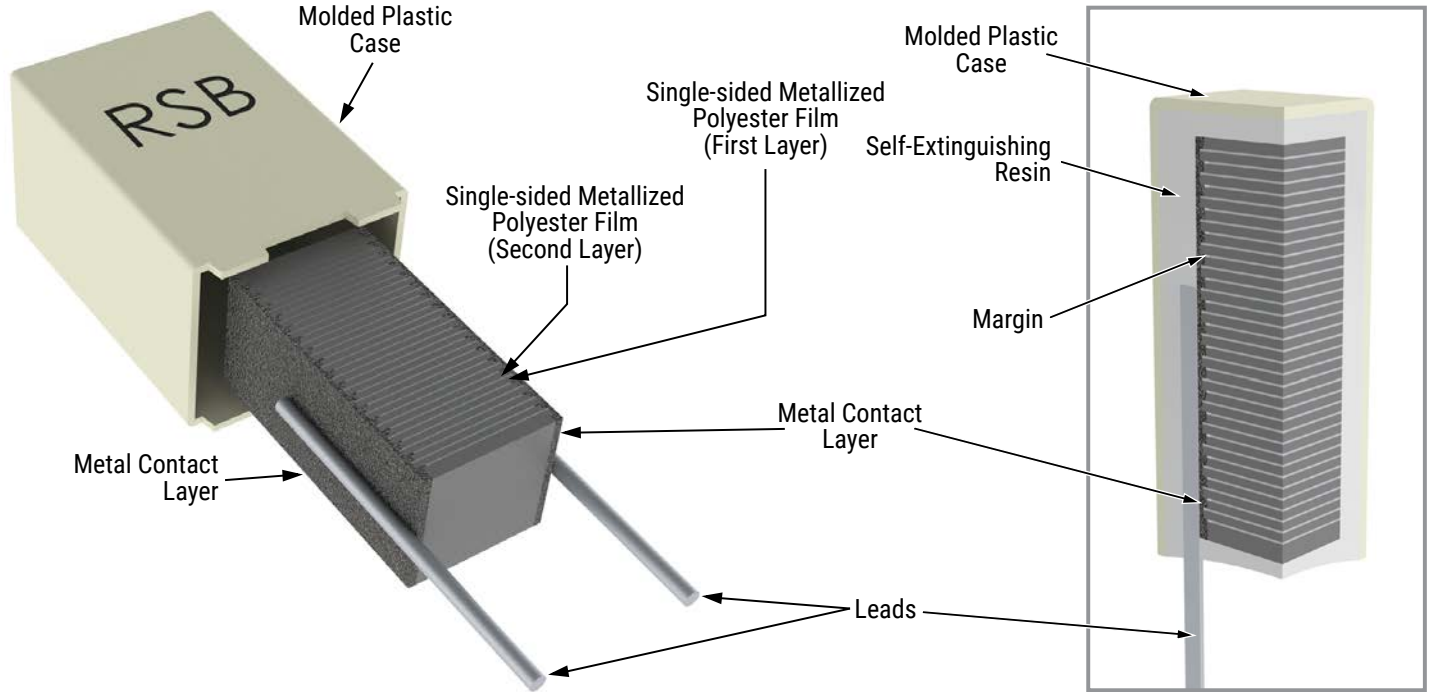

## Marking

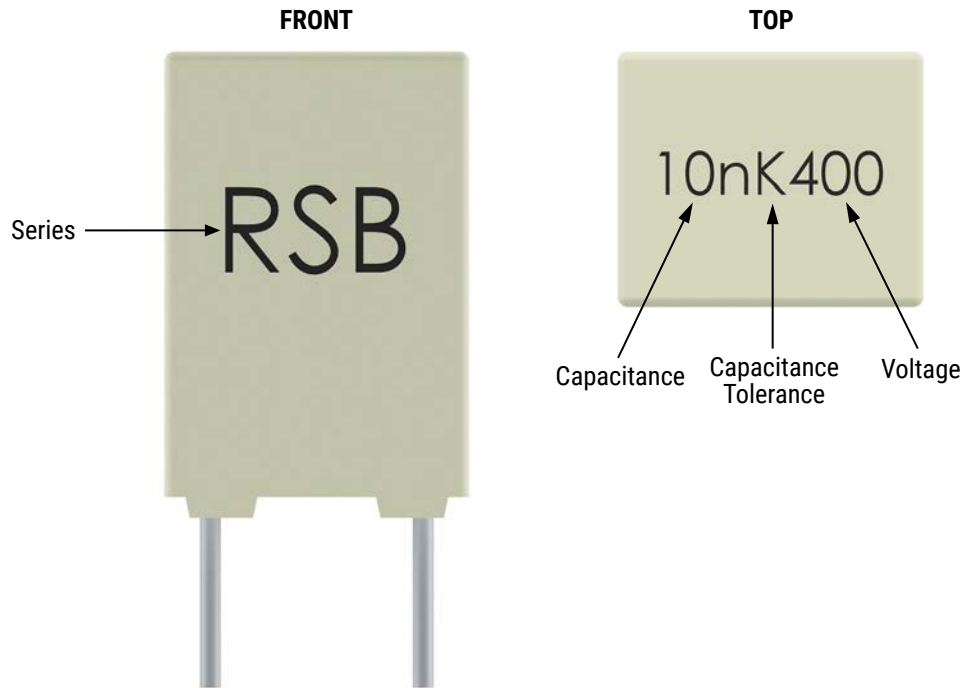

## Packaging Quantities

Lead Spacing	Thickness (mm)	Height (mm)	Length (mm)	Bulk Short Leads	Bulk Long Leads	Standard Reel 355 mm	Ammo Taped
5	2.5	6.5	7.2	3,000	4,000	2,500	3,500
	3.5	7.5	7.2	2,000	3,000	1,800	2,500
	4.5	9.5	7.2	1,500	2,000	1,400	1,900
	5.0	10.0	7.2	1,000	1,500	1,200	1,700
	6.0	11.0	7.2	2,000	1,000	1,000	1,400
	7.2	13.0	7.2	1,500	750	800	1,150

## Lead Taping & Packaging (IEC 60286-2)

Figure 1 – Lead Spacing 5 & 7.5 mm



Figure 2 – Lead Spacing 7.5 mm



Description	Symbol	Dimensions (mm)				Tolerance
		Lead Spacing			Tolerance	
		5 Figure 1	7.5 Figure 1	7.5 Figure 2		
Lead wire diameter	d	0.5 – 0.6	0.5 – 0.6	0.5 – 0.6	±0.05	
Taping lead space	P	12.7	12.7	12.7	±1	
Feed hole lead space	P <sub>0</sub>	12.7	12.7	12.7	±0.2*	
Centering of the lead wire	P <sub>1</sub>	3.85	2.6	3.75	±0.7	
Centering of the body	P <sub>2</sub>	6.35	6.35		±1.3	
Lead spacing	F	5	7.5	7.5	+0.6/-0.1	
Component alignment	Δh	0	0	0	±2	
Height of component from tape center	H <sub>0</sub> **	18.5	18.5	18.5	±0.5	
Carrier tape width	W	18	18	18	+1/-0.5	
Hold down tape width	W <sub>0</sub>	6	6	6	Minimum	
Hole position	W <sub>1</sub>	9	9	9	±0.5	
Hold down tape position	W <sub>2</sub>	3	3	3	Maximum	
Feed hole diameter	D <sub>0</sub>	4	4	4	±0.2	
Tape thickness	t	0.7	0.7	0.7	±0.2	

\*Maximum 1 mm on 20 lead spaces.

\*\*H<sub>0</sub> = 16.5 mm is available upon request.

For orders of capacitors with lead space = 7.5 mm, please specify the requested version (Figure 1 or Figure 2).



## Ammo Specifications

Dimensions in mm		
H	W	T
360 *	340	59

\* Lower dimension available upon request (maximum 295 mm)



## Reel Specifications

Dimensions in mm		
D	H	W
355	30	55 maximum



## KEMET Electronics Corporation Sales Offices

For a complete list of our global sales offices, please visit [www.kemet.com/sales](http://www.kemet.com/sales).

---

### Disclaimer

All product specifications, statements, information and data (collectively, the "Information") in this datasheet are subject to change. The customer is responsible for checking and verifying the extent to which the Information contained in this publication is applicable to an order at the time the order is placed. All Information given herein is believed to be accurate and reliable, but it is presented without guarantee, warranty, or responsibility of any kind, expressed or implied.

Statements of suitability for certain applications are based on KEMET Electronics Corporation's ("KEMET") knowledge of typical operating conditions for such applications, but are not intended to constitute – and KEMET specifically disclaims – any warranty concerning suitability for a specific customer application or use. The Information is intended for use only by customers who have the requisite experience and capability to determine the correct products for their application. Any technical advice inferred from this Information or otherwise provided by KEMET with reference to the use of KEMET's products is given gratis, and KEMET assumes no obligation or liability for the advice given or results obtained.

Although KEMET designs and manufactures its products to the most stringent quality and safety standards, given the current state of the art, isolated component failures may still occur. Accordingly, customer applications which require a high degree of reliability or safety should employ suitable designs or other safeguards (such as installation of protective circuitry or redundancies) in order to ensure that the failure of an electrical component does not result in a risk of personal injury or property damage.

Although all product-related warnings, cautions and notes must be observed, the customer should not assume that all safety measures are indicated or that other measures may not be required.

*KEMET is a registered trademark of KEMET Electronics Corporation.*



Компания «ЭлектроПласт» предлагает заключение долгосрочных отношений при поставках импортных электронных компонентов на взаимовыгодных условиях!

Наши преимущества:

- Оперативные поставки широкого спектра электронных компонентов отечественного и импортного производства напрямую от производителей и с крупнейших мировых складов;
- Поставка более 17-ти миллионов наименований электронных компонентов;
- Поставка сложных, дефицитных, либо снятых с производства позиций;
- Оперативные сроки поставки под заказ (от 5 рабочих дней);
- Экспресс доставка в любую точку России;
- Техническая поддержка проекта, помощь в подборе аналогов, поставка прототипов;
- Система менеджмента качества сертифицирована по Международному стандарту ISO 9001;
- Лицензия ФСБ на осуществление работ с использованием сведений, составляющих государственную тайну;
- Поставка специализированных компонентов (Xilinx, Altera, Analog Devices, Intersil, Interpoint, Microsemi, Aeroflex, Peregrine, Syfer, Eurofarad, Texas Instrument, Miteq, Cobham, E2V, MA-COM, Hittite, Mini-Circuits, General Dynamics и др.);

Помимо этого, одним из направлений компании «ЭлектроПласт» является направление «Источники питания». Мы предлагаем Вам помощь Конструкторского отдела:

- Подбор оптимального решения, техническое обоснование при выборе компонента;
- Подбор аналогов;
- Консультации по применению компонента;
- Поставка образцов и прототипов;
- Техническая поддержка проекта;
- Защита от снятия компонента с производства.



#### Как с нами связаться

**Телефон:** 8 (812) 309 58 32 (многоканальный)

**Факс:** 8 (812) 320-02-42

**Электронная почта:** [org@eplast1.ru](mailto:org@eplast1.ru)

**Адрес:** 198099, г. Санкт-Петербург, ул. Калинина, дом 2, корпус 4, литера А.