

4-Pin Super Flux Blue LED Lamp Orca R Series (4.6mm Dome)



R20BLU-4-0045

- ◆ RoHS Compliant
- ◆ Low Profile Dome Lens
- ◆ Automatic Insertion Compatible — Tubular Packaging
- ◆ Automatic Placement Compatible
- ◆ High Intensity Output
- ◆ High Power Efficiency



Bivar **R20BLU-4-0045** comes with low profile package design incorporating higher forward current to maximize intensity while minimizing the number of LEDs required to achieve uniform and enhanced light distribution. Low power consumption with quick response time means savings in electricity.

Bivar **R20BLU-4-0045** can be coupled with reflectors or lenses for optimal light distribution needs. Typical applications are automotive exterior lighting, decorative interior or exterior lighting, specialty stage lighting, and electronic signage.

Part Number	Material	Emitted Color	Intensity Typ. mcd	Lens Color	Viewing Angle
R20BLU-4-0045	InGaN/Sapphire	Blue	1500	Water Clear	45°

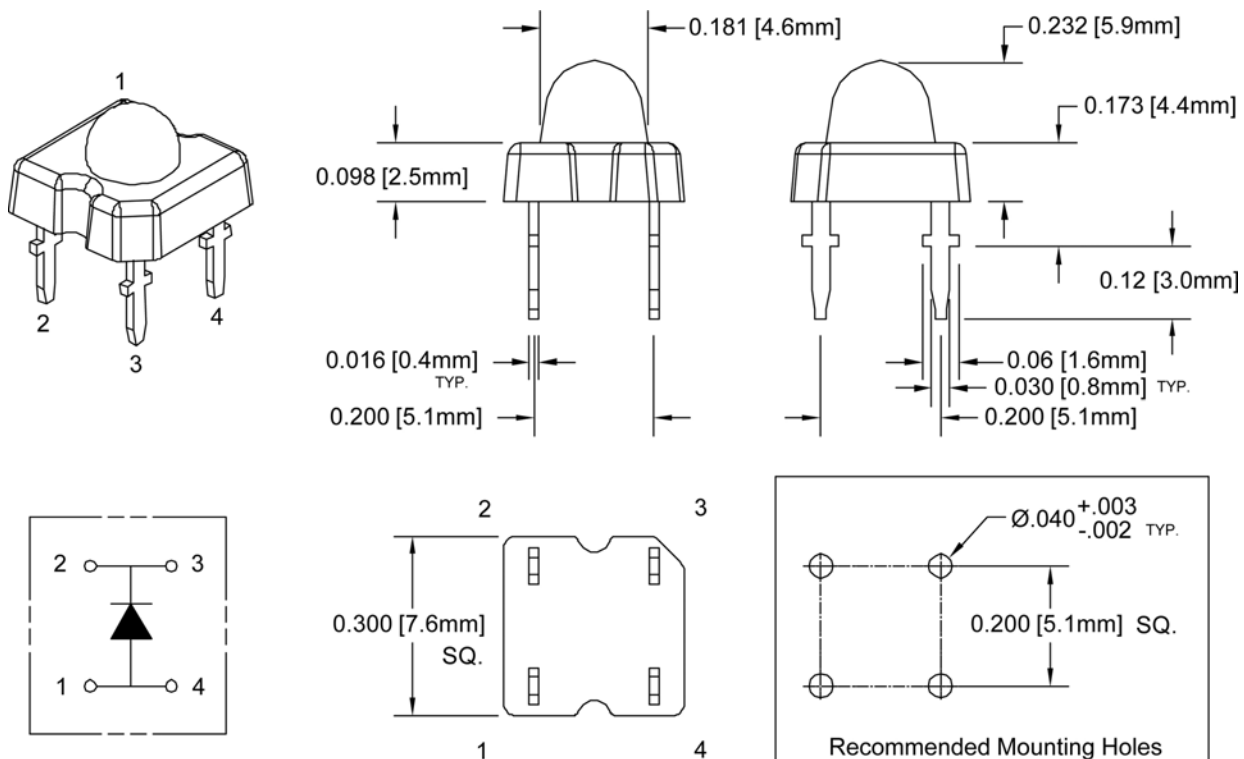

Outline Drawings Notes:

1. All dimensions are in inches [millimeters].
2. Standard tolerance: ± 0.010 " unless otherwise noted.
3. Tolerance of overall epoxy outline: ± 0.020 " unless otherwise noted.
4. Epoxy meniscus may extend to 0.060" max.



Bivar reserves the right to make changes at any time.

4-Pin Super Flux Blue LED Lamp R20BLU-4-0045



Absolute Maximum Ratings

$T_A = 25^\circ\text{C}$ unless otherwise noted

Power Dissipation	220 mW
Forward Current (DC)	50 mA
Peak Forward Current ¹	100 mA
Electrostatic Discharge (Class1)	2000 V
Reverse Voltage	5 V
Operating Temperature Range	-25 ~ +80°C
Storage Temperature Range	-30 ~ +80°C
Lead Soldering Temperature (3 mm from the base of the epoxy bulb) ²	260°C

- Notes: 1. 10% Duty Cycle, Pulse Width ≤ 0.1 msec.
2. Solder time less than 5 seconds at temperature extreme.

Electrical Characteristics

$T_A = 25^\circ\text{C}$ & $I_F = 20$ mA unless otherwise noted

Emitting Color	Forward Voltage (V) ¹			Recommend Forward Current (mA)	Reverse Current (μA) $V_R=5\text{V}$	Dominant Wavelength (nm) ²		Luminous Intensity (mcd) ³		Viewing Angle $2\theta_{1/2}$ (deg)
	MIN	TYP	MAX	TYP	MAX	MIN	MAX	MIN	TYP	TYP
Blue	3.0	3.4	3.8	20	10	465	475	1000	1500	45

- Notes: 1. Tolerance of Forward Voltage : $\pm 0.05\text{V}$.
2. Tolerance of Dominant Wavelength : $\pm 0.1\text{nm}$.
3. Tolerance of Luminous Intensity : $\pm 15\%$.

Directivity Radiation

$T_A = 25^\circ\text{C}$ unless otherwise noted

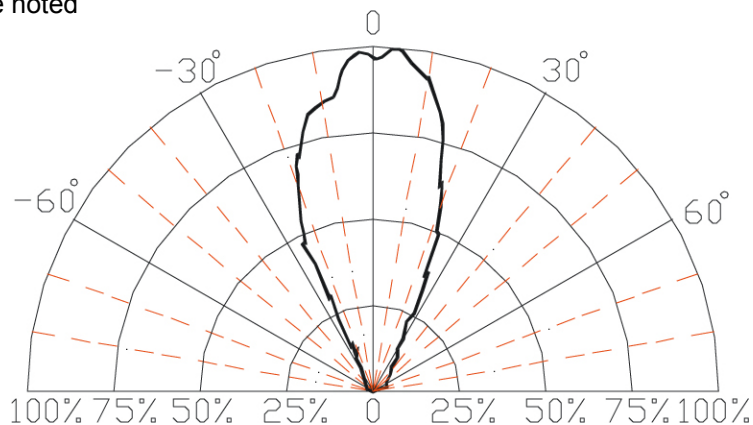

Relative Luminous Intensity vs. Radiation Angle

Bivar reserves the right to make changes at any time.

4-Pin Super Flux Blue LED Lamp R20BLU-4-0045



Typical Electrical / Optical Characteristics Curves

$T_A = 25^\circ\text{C}$ unless otherwise noted

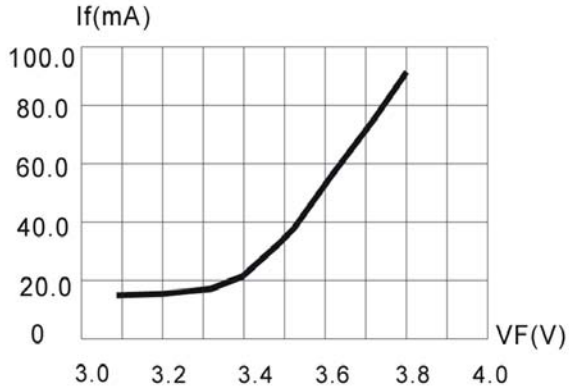

Fig.1 Forward Current vs. Forward Voltage

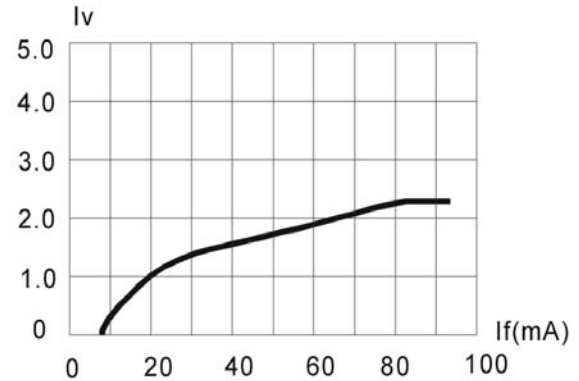

Fig.2 Relative Luminous Intensity vs. Forward Current

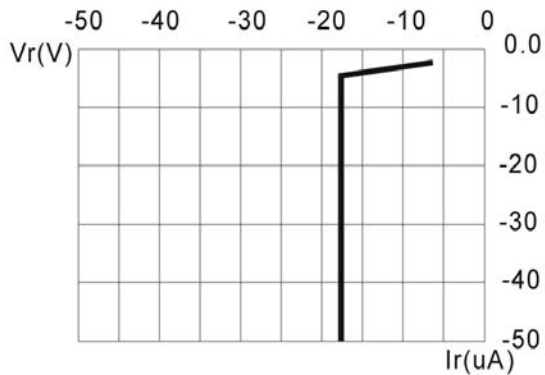

Fig.3 Reverse Current vs. Reverse Voltage

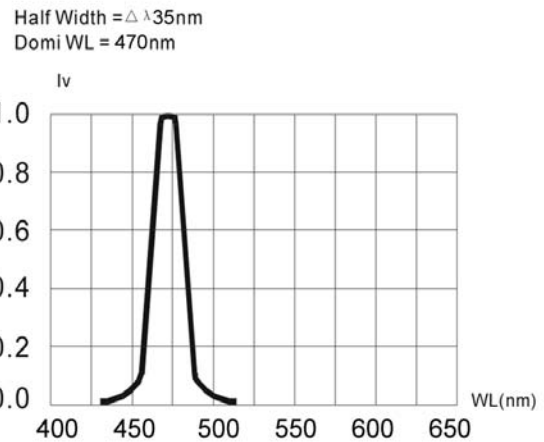

Fig.4 Relative Luminous Intensity vs. Wavelength

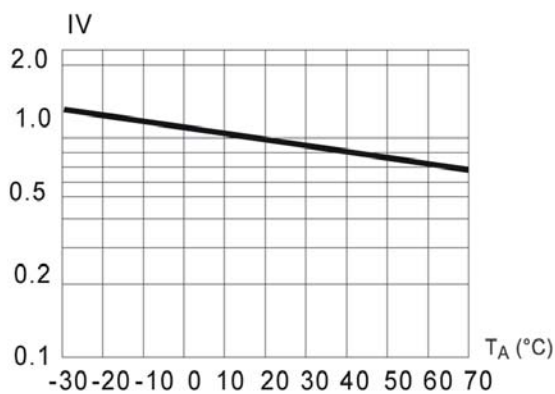

Fig.5 Relative Luminous Intensity vs. Ambient Temperature

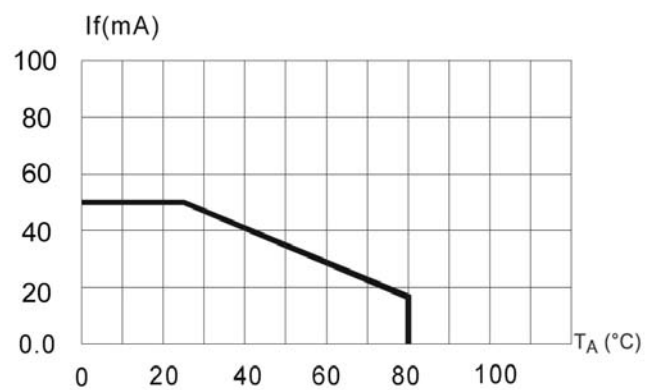

Fig.6 Maximum Forward Current vs. Ambient Temperature

Bivar reserves the right to make changes at any time.

4-Pin Super Flux Blue LED Lamp R20BLU-4-0045



Recommended Soldering Conditions



Recommended Lead Free Wave Soldering Profile	
Preheat Temperature: 100°C Max.	Peak Temperature: 260°C Max.
Preheat Time: 20 ~ 50 Seconds	Solder Time Above 217°C: 5 Seconds Max.
Note: Turn off top heater at preheat to prevent the lamp body directly exposed to the heat source.	

Packaging and Labeling Plan

Bivar Orca R series Super Flux LEDs are packaged in tubes, each of which contains 60 LEDs; and each tube contains a rubber stopper at each end.



Note: 60 pcs Max./Antistatic Tube



Detail A

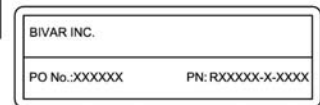

Detail B

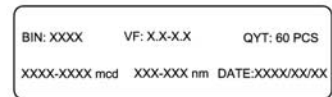

Detail C

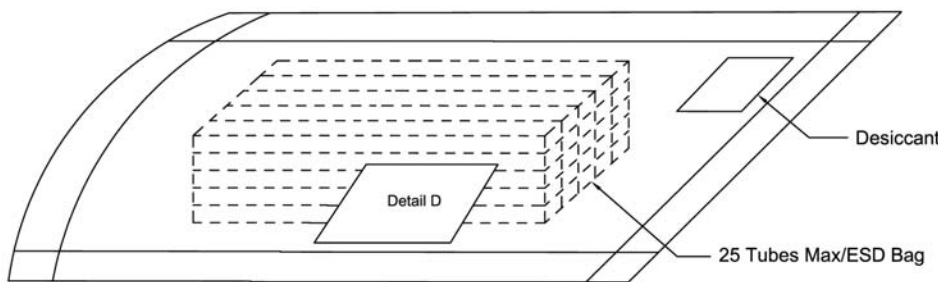

Note: 1500 pcs Max/ESD bag



Detail D

Bivar reserves the right to make changes at any time.



Компания «ЭлектроПласт» предлагает заключение долгосрочных отношений при поставках импортных электронных компонентов на взаимовыгодных условиях!

Наши преимущества:

- Оперативные поставки широкого спектра электронных компонентов отечественного и импортного производства напрямую от производителей и с крупнейших мировых складов;
- Поставка более 17-ти миллионов наименований электронных компонентов;
- Поставка сложных, дефицитных, либо снятых с производства позиций;
- Оперативные сроки поставки под заказ (от 5 рабочих дней);
- Экспресс доставка в любую точку России;
- Техническая поддержка проекта, помощь в подборе аналогов, поставка прототипов;
- Система менеджмента качества сертифицирована по Международному стандарту ISO 9001;
- Лицензия ФСБ на осуществление работ с использованием сведений, составляющих государственную тайну;
- Поставка специализированных компонентов (Xilinx, Altera, Analog Devices, Intersil, Interpoint, Microsemi, Aeroflex, Peregrine, Syfer, Eurofarad, Texas Instrument, Miteq, Cobham, E2V, MA-COM, Hittite, Mini-Circuits, General Dynamics и др.);

Помимо этого, одним из направлений компании «ЭлектроПласт» является направление «Источники питания». Мы предлагаем Вам помощь Конструкторского отдела:

- Подбор оптимального решения, техническое обоснование при выборе компонента;
- Подбор аналогов;
- Консультации по применению компонента;
- Поставка образцов и прототипов;
- Техническая поддержка проекта;
- Защита от снятия компонента с производства.



Как с нами связаться

Телефон: 8 (812) 309 58 32 (многоканальный)

Факс: 8 (812) 320-02-42

Электронная почта: org@eplast1.ru

Адрес: 198099, г. Санкт-Петербург, ул. Калинина, дом 2, корпус 4, литера А.