

PTFB091507FH

Thermally-Enhanced High Power RF LDMOS FET 160 W, 28 V, 920 – 960 MHz

Description

The PTFB091507FH is an LDMOS FET intended for use in multi-standard cellular power amplifier applications in the 920 to 960 MHz frequency band. Features include input and output matching, high gain and thermally-enhanced package with earless flange. Manufactured with Wolfspeed's advanced LDMOS process, this device provides excellent thermal performance and superior reliability.

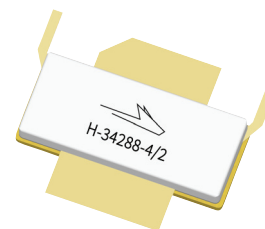

PTFB091507FH
Package H-34288-4/2

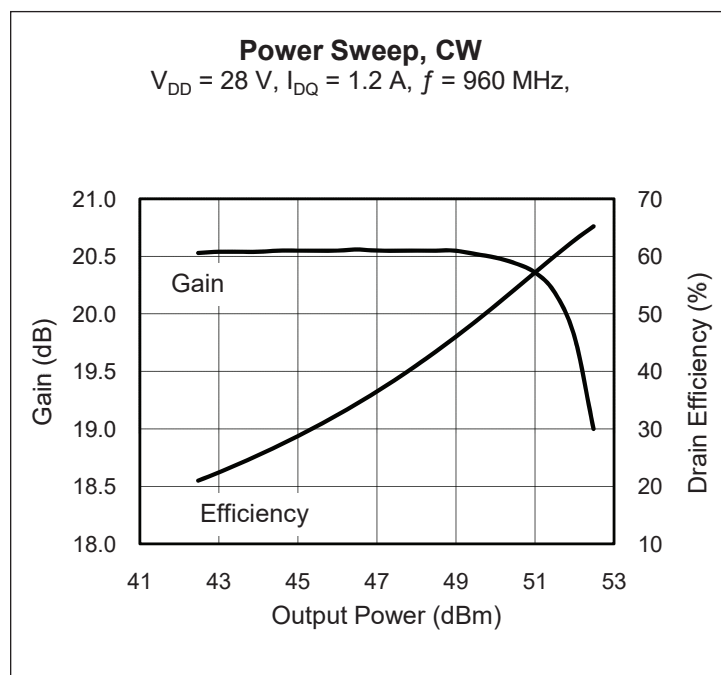

Features

- Broadband internal matching
- Wide video bandwidth
- Typical CW performance, 960 MHz, 28 V
 - Average output power = 160 W
 - Gain = 19.5 dB
 - Efficiency = 60%
- Integrated ESD protection
- Low thermal resistance
- Thermally enhanced package is Pb-free and RoHS compliant
- Capable of handling 10:1 VSWR @ 28 V, 160 W (CW) output power

RF Characteristics

Single-carrier WCDMA Specifications (not subject to production test; verified by design/characterization in Wolfspeed test fixture)

$V_{DD} = 28\text{ V}$, $I_{DQ} = 1.2\text{ A}$, $P_{OUT} = 50\text{ W}$ average

$f = 960\text{ MHz}$, 3GPP signal, channel bandwidth = 3.84 MHz, PAR = 7.5 dB @ 0.01% CCDF probability

Characteristic	Symbol	Min	Typ	Max	Unit
Gain	Gps	—	20	—	dB
Drain Efficiency	η_D	—	38	—	%
Adjacent Channel Power Ratio	ACPR	—	-36	—	dBc

All published data at $T_{CASE} = 25^\circ\text{C}$ unless otherwise indicated

ESD: Electrostatic discharge sensitive device—observe handling precautions!

RF Characteristics (cont.)**Two-tone Measurements** (tested in WolfSpeed test fixture)

$V_{DD} = 28\text{ V}$, $I_{DQ} = 1.2\text{ A}$, $P_{OUT} = 70\text{ W avg}$, $f = 960\text{ MHz}$, tone spacing = 1 MHz

Characteristic	Symbol	Min	Typ	Max	Unit
Gain	Gps	19.5	20	—	dB
Drain Efficiency	η_D	43.5	45	—	%
Intermodulation Distortion	IMD	—	-30	-28	dBc

DC Characteristics

Characteristic	Conditions	Symbol	Min	Typ	Max	Unit
Drain-Source Breakdown Voltage	$V_{GS} = 0\text{ V}$, $I_{DS} = 10\text{ mA}$	$V_{(BR)DSS}$	65	—	—	V
Drain Leakage Current	$V_{DS} = 28\text{ V}$, $V_{GS} = 0\text{ V}$	I_{DSS}	—	—	1.0	μA
	$V_{DS} = 63\text{ V}$, $V_{GS} = 0\text{ V}$		—	—	1.0	μA
On-State Resistance	$V_{GS} = 10\text{ V}$, $V_{DS} = 0.1\text{ V}$	$R_{DS(on)}$	—	0.05	—	Ω
Operating Gate Voltage	$V_{DS} = 28\text{ V}$, $I_{DQ} = 1.2\text{ A}$	V_{GS}	2.5	3.9	4.5	V
Gate Leakage Current	$V_{GS} = 10\text{ V}$, $V_{DS} = 0\text{ V}$	I_{GSS}	—	—	1.0	μA

Maximum Ratings

Parameter	Symbol	Value	Unit
Drain-Source Voltage	V_{DSS}	65	V
Gate-Source Voltage	V_{GS}	-6 to +10	V
Junction Temperature	T_J	200	$^{\circ}\text{C}$
Storage Temperature Range	T_{STG}	-40 to +150	$^{\circ}\text{C}$
Thermal Resistance ($T_{CASE} = 70^{\circ}\text{C}$)	$R_{\theta JC}$	0.31	$^{\circ}\text{C/W}$

Ordering Information

Type and Version	Order Code	Package Description	Shipping
PTFB091507FH V1 R0	PTFB091507FH-V1-R0	H-34288-4/2, earless flange	Tape & Reel, 50 pcs
PTFB091507FH V1 R250	PTFB091507FH-V1-R250	H-34288-4/2, earless flange	Tape & Reel, 250 pcs

Typical Performance (data taken in Wolfspeed test fixture)

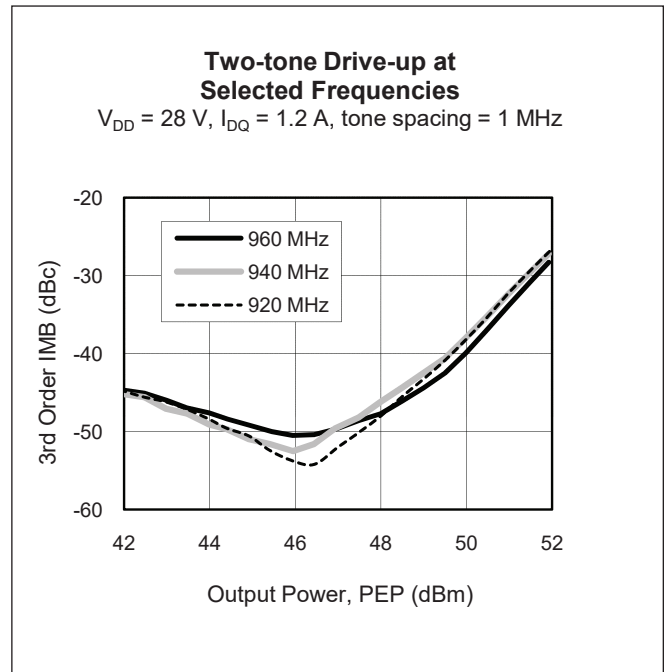
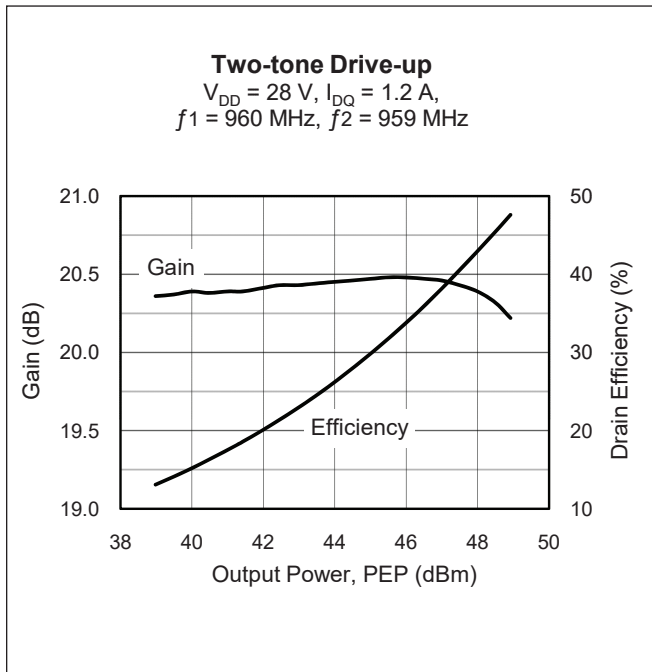
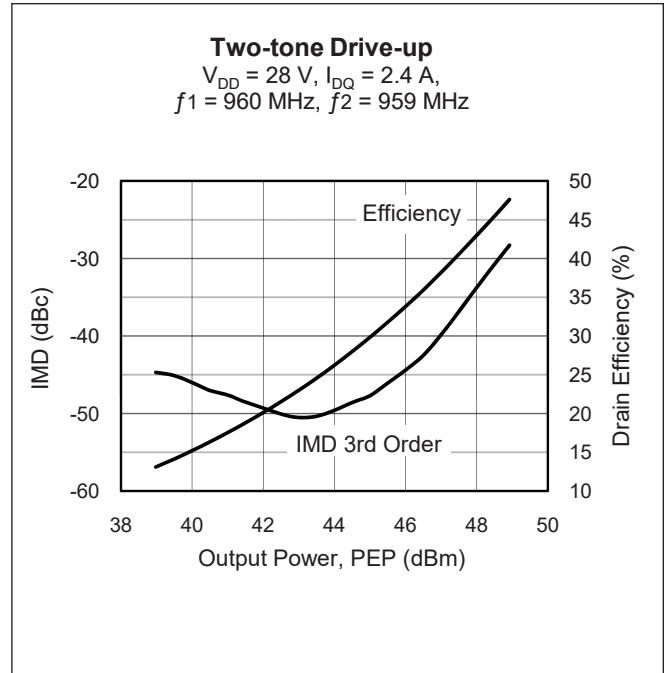
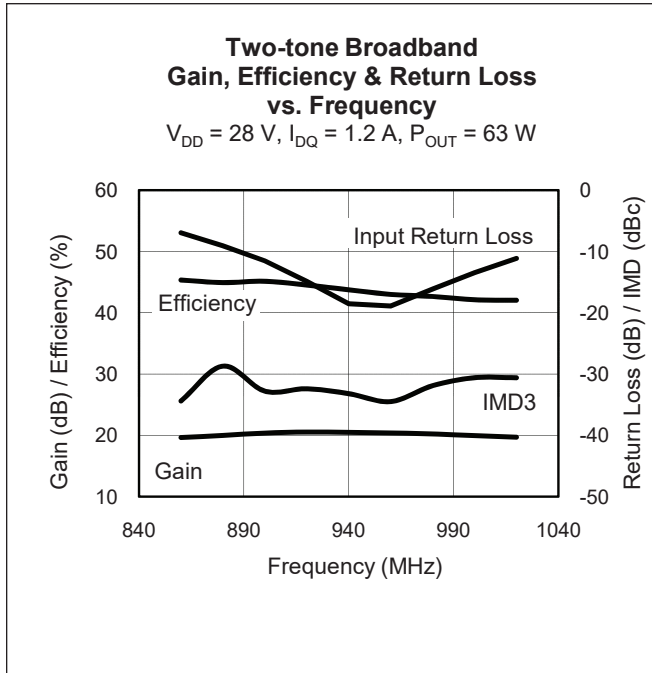



Typical Performance (cont.)

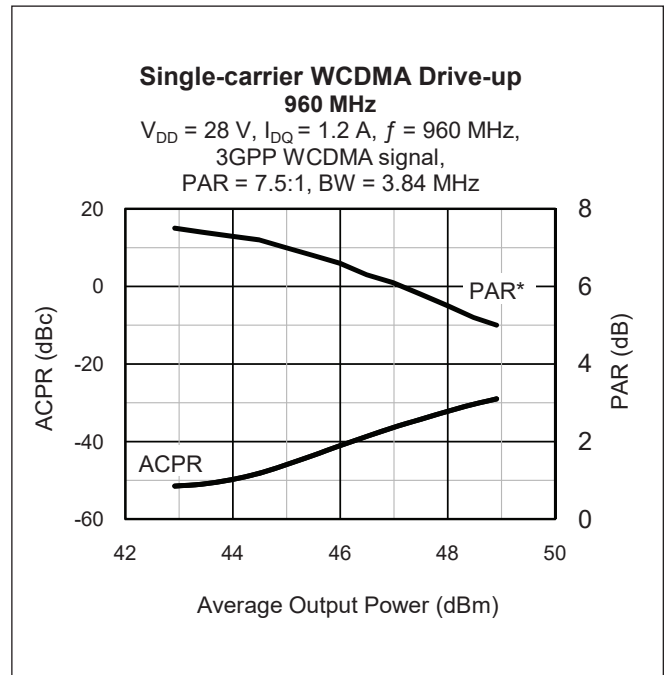
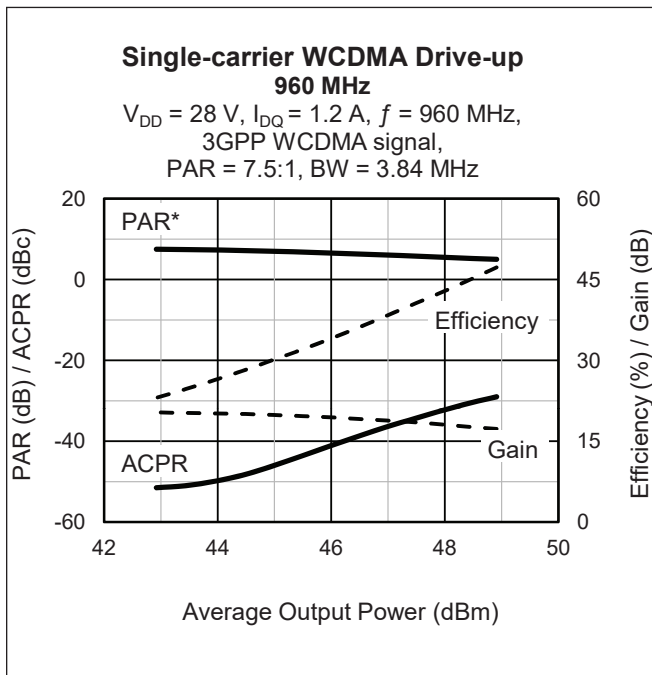
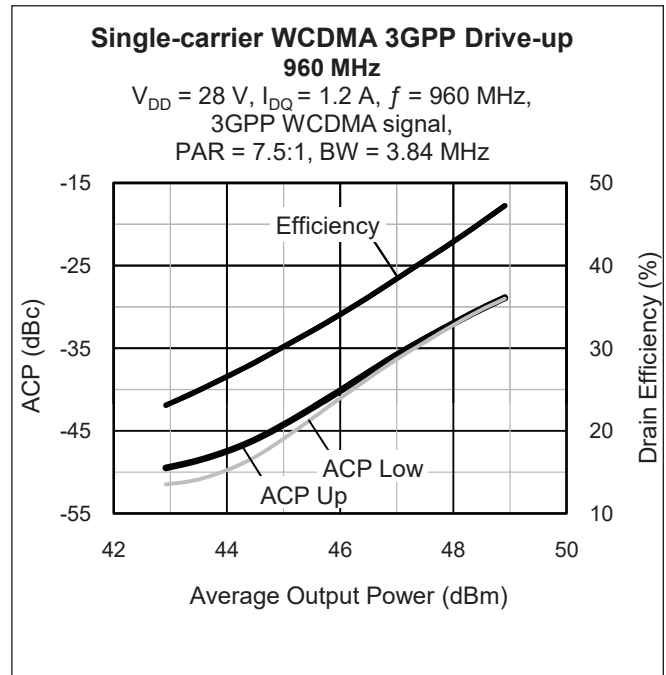
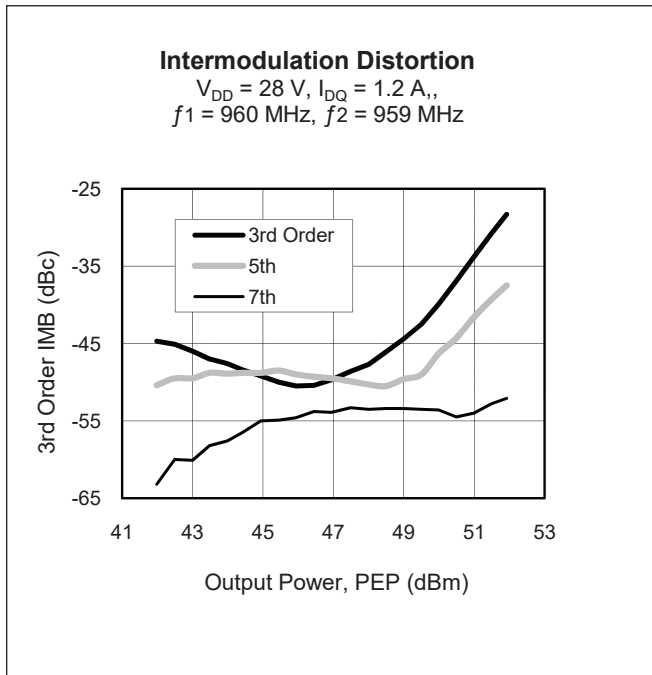

*Peak-to-average ratio (PAR) compression at 0.01% probability on CCDF curve

Typical Performance (cont.)

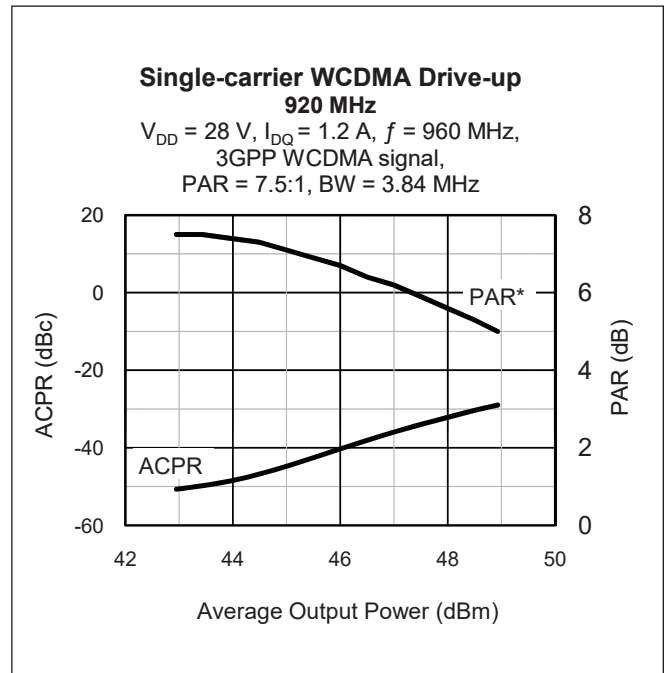
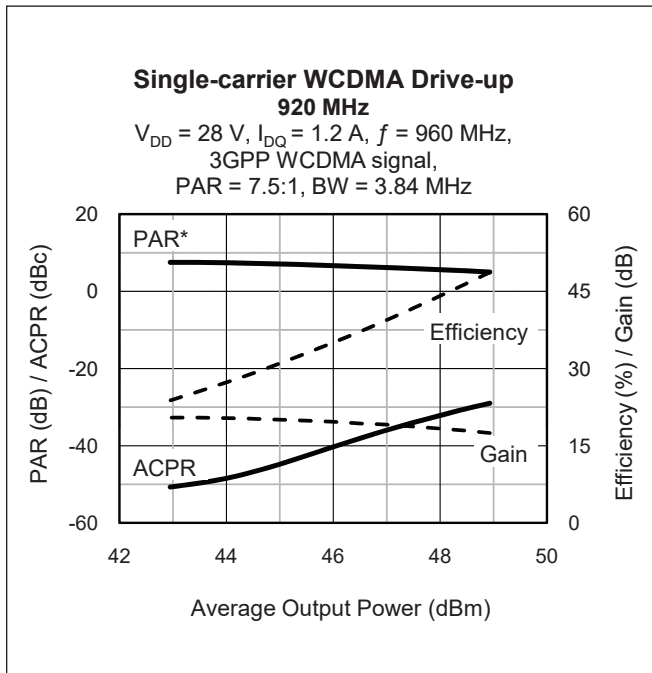
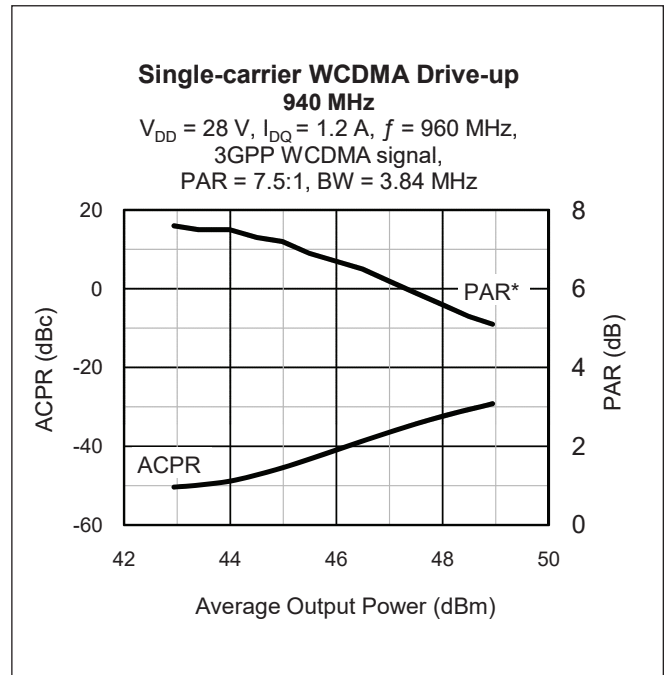
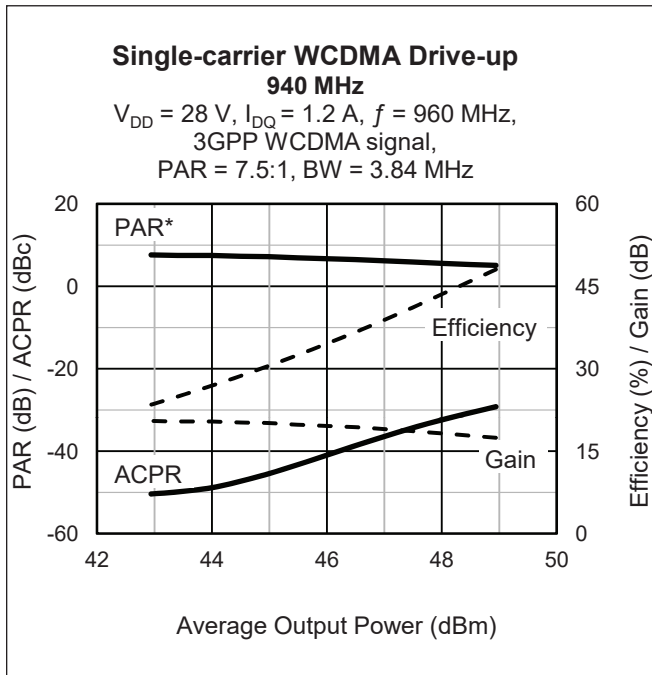

*Peak-to-average ratio (PAR) compression at 0.01% probability on CCDF curve

Broadband Circuit Impedance

Frequency MHz	Z source (W)		Z Load (W)	
	R	jX	R	jX
910	2.23	-3.12	1.53	-0.87
920	2.23	-3.03	1.52	-0.84
930	2.23	-2.95	1.50	-0.81
940	2.24	-2.87	1.49	-0.77
950	2.25	-2.80	1.46	-0.74
960	2.26	-2.73	1.44	-0.71
970	2.27	-2.65	1.42	-0.67

See next page for Reference Circuit information

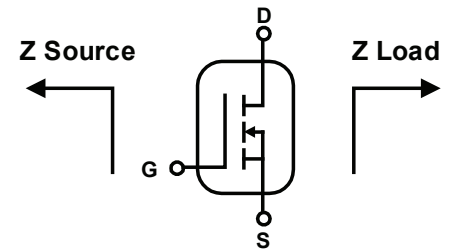

Reference Circuit

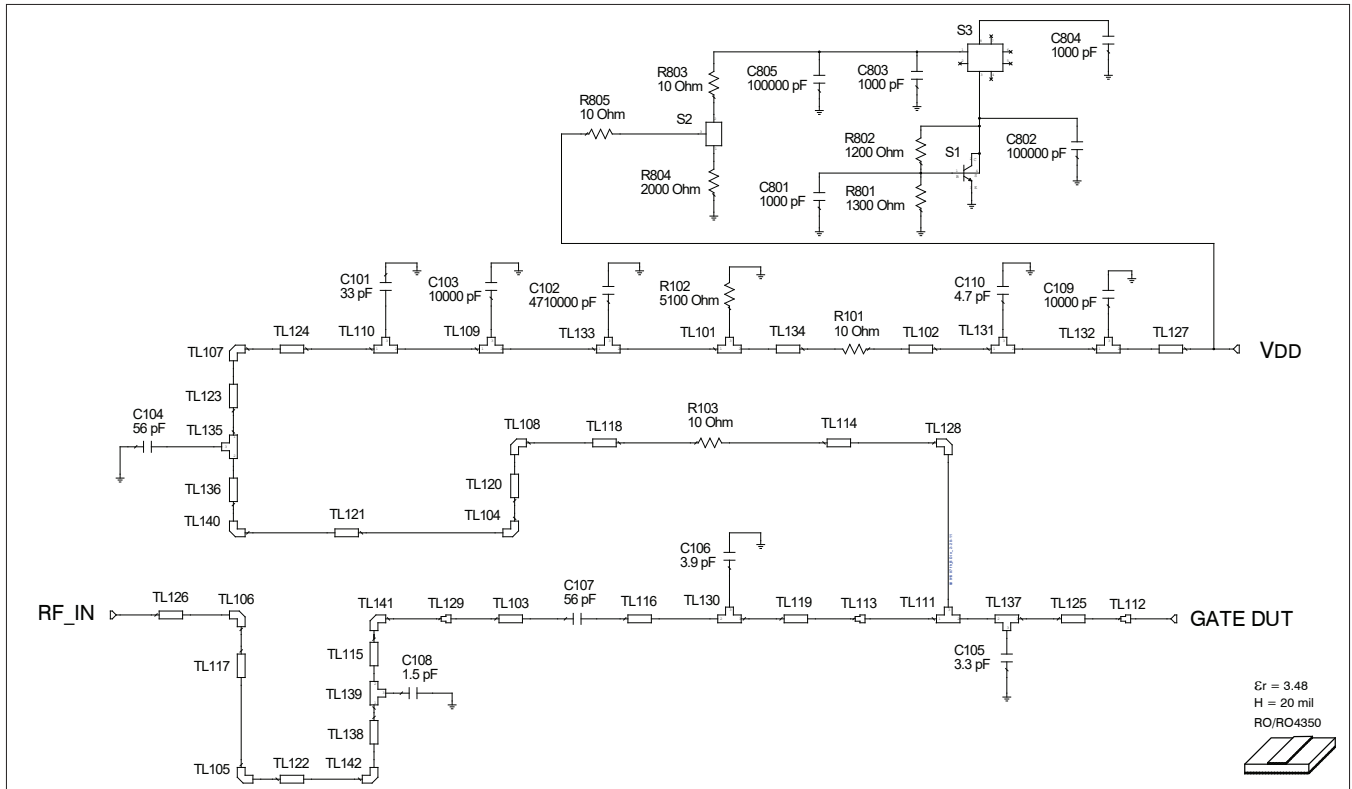

Reference circuit input schematic for $f = 960$ MHz

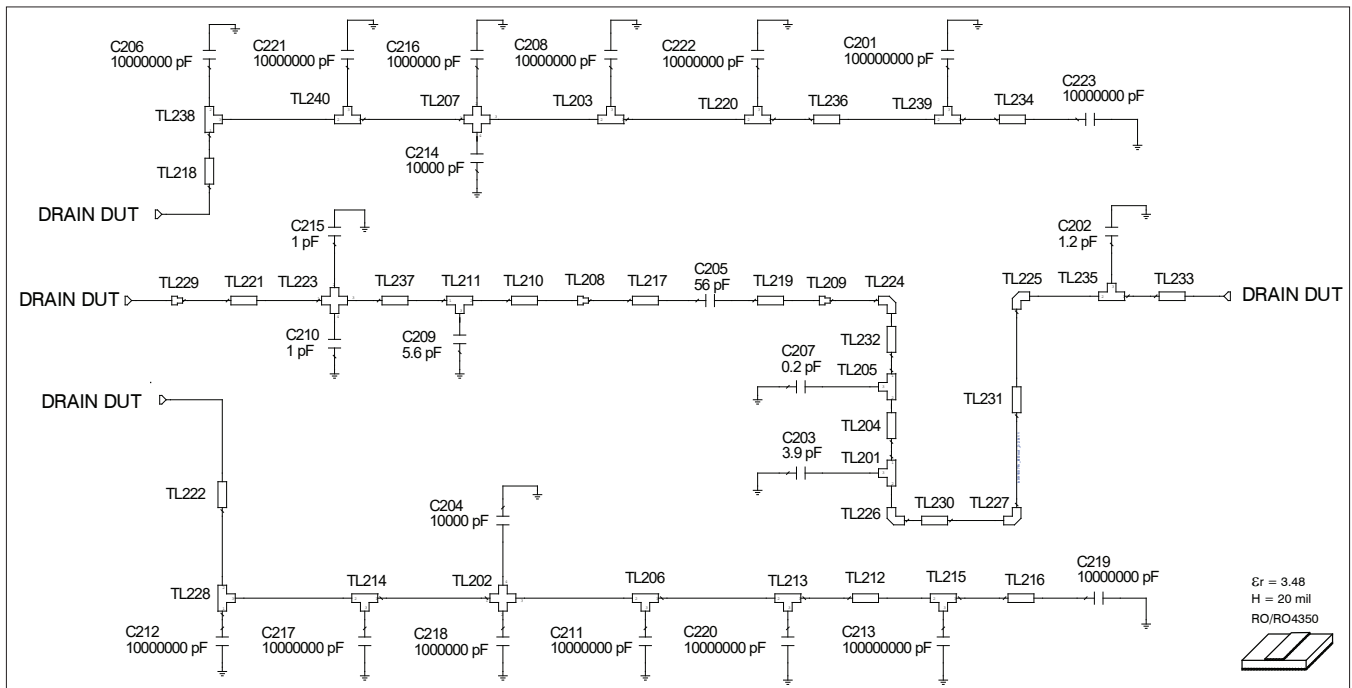

Reference circuit output schematic for $f = 960$ MHz



Reference Circuit (cont.)

DUT	PTFB091507FH
Test Fixture Part No.	LTN/PTFB091507FH
PCB	Rogers RO4350, 0.508 mm [0.020"] thick, 2 oz. copper, $\epsilon_r = 3.48$
Gerber Files	Find Gerber files for this test fixture on the Wolfspeed Web site at www.wolfspeed.com/RF

Electrical Characteristics at 960 MHz

Microstrip	Characteristics	Dimensions: mm	Dimensions: mils
TL102	0.004 λ , 26.8 Ω	W = 2.79, L = 0.76	W = 110, L = 30
TL103	0.007 λ , 39.1 Ω	W = 1.68, L = 1.27	W = 66, L = 50
TL111	0.004 λ , 5.3 Ω	W1 = 17.78, W2 = 17.78, W3 = 0.76	W1 = 700, W2 = 700, W3 = 30
TL114	0.003 λ , 63.9 Ω	W = 0.76, L = 0.51	W = 30, L = 20
TL115	0.026 λ , 51.5 Ω	W = 1.10, L = 4.88	W = 44, L = 192
TL116	0.036 λ , 39.1 Ω	W = 1.68, L = 6.74	W = 66, L = 266
TL117	0.042 λ , 51.5 Ω	W = 1.10, L = 8.00	W = 44, L = 315
TL118	0.007 λ , 63.9 Ω	W = 0.76, L = 1.27	W = 30, L = 50
TL119	0.035 λ , 39.1 Ω	W = 1.68, L = 6.49	W = 66, L = 256
TL120	0.015 λ , 63.9 Ω	W = 0.76, L = 2.92	W = 30, L = 115
TL121	0.100 λ , 63.9 Ω	W = 0.76, L = 19.05	W = 30, L = 750
TL122	0.005 λ , 51.5 Ω	W = 1.10, L = 1.02	W = 44, L = 40
TL123	0.008 λ , 63.9 Ω	W = 0.76, L = 1.52	W = 30, L = 60
TL124	0.006 λ , 26.8 Ω	W = 2.79, L = 1.04	W = 110, L = 41
TL125	0.102 λ , 5.3 Ω	W = 17.78, L = 17.55	W = 700, L = 691
TL126	0.040 λ , 51.5 Ω	W = 1.10, L = 7.57	W = 44, L = 298
TL127	0.004 λ , 26.8 Ω	W = 2.79, L = 0.76	W = 110, L = 30
TL130	0.011 λ , 39.1 Ω	W1 = 1.68, W2 = 1.68, W3 = 2.03	W1 = 66, W2 = 66, W3 = 80
TL134	0.007 λ , 26.8 Ω	W = 2.79, L = 1.19	W = 110, L = 47
TL136	0.008 λ , 63.9 Ω	W = 0.76, L = 1.52	W = 30, L = 60
TL137	0.016 λ , 5.3 Ω	W1 = 17.78, W2 = 17.78, W3 = 2.79	W1 = 700, W2 = 700, W3 = 110
TL138	0.002 λ , 51.5 Ω	W = 1.10, L = 0.33	W = 44, L = 13
TL139	0.015 λ , 51.5 Ω	W1 = 1.10, W2 = 1.10, W3 = 2.79	W1 = 44, W2 = 44, W3 = 110
TL201	0.004 λ , 51.5 Ω	W1 = 1.10, W2 = 1.10, W3 = 0.76	W1 = 44, W2 = 44, W3 = 30
TL202, 207	0.010 λ , 20.9 Ω	W1 = 3.81, W2 = 1.83, W3 = 3.81, W4 = 1.83	W1 = 150, W2 = 72, W3 = 150, W4 = 72
TL203	0.016 λ , 20.9 Ω	W1 = 3.81, W2 = 3.81, W3 = 2.79	W1 = 150, W2 = 150, W3 = 110
TL204	0.014 λ , 51.5 Ω	W = 1.10, L = 2.67	W = 44, L = 105
TL205	0.015 λ , 51.5 Ω	W1 = 1.10, W2 = 1.10, W3 = 2.79	W1 = 44, W2 = 44, W3 = 110
TL206	0.016 λ , 20.9 Ω	W1 = 3.81, W2 = 3.81, W3 = 2.79	W1 = 150, W2 = 150, W3 = 110
TL210	0.109 λ , 5.7 Ω	W = 16.51, L = 18.62	W = 650, L = 733
TL211	0.016 λ , 5.7 Ω	W1 = 16.51, W2 = 16.51, W3 = 2.79	W1 = 650, W2 = 650, W3 = 110
TL212	0.014 λ , 20.9 Ω	W = 3.81, L = 2.51	W = 150, L = 99
TL213	0.016 λ , 20.9 Ω	W1 = 3.81, W2 = 3.81, W3 = 2.79	W1 = 150, W2 = 150, W3 = 110
TL214	0.007 λ , 20.9 Ω	W1 = 3.81, W2 = 3.81, W3 = 1.27	W1 = 150, W2 = 150, W3 = 50

table continued on next page

Reference Circuit (cont.)

Microstrip	Characteristics	Dimensions: mm	Dimensions: mils
TL215	0.021 λ , 20.9 Ω	W1 = 3.81, W2 = 3.81, W3 = 3.81	W1 = 150, W2 = 150, W3 = 150
TL216	0.041 λ , 20.9 Ω	W = 3.81, L = 7.29	W = 150, L = 287
TL217	0.008 λ , 39.1 Ω	W = 1.68, L = 1.52	W = 66, L = 60
TL218	0.016 λ , 16.5 Ω	W = 5.08, L = 2.90	W = 200, L = 114
TL219	0.011 λ , 39.1 Ω	W = 1.68, L = 2.03	W = 66, L = 80
TL220	0.016 λ , 20.9 Ω	W1 = 3.81, W2 = 3.81, W3 = 2.79	W1 = 150, W2 = 150, W3 = 110
TL221	0.037 λ , 5.7 Ω	W = 16.51, L = 6.38	W = 650, L = 251
TL222	0.016 λ , 16.5 Ω	W = 5.08, L = 2.89	W = 200, L = 114
TL223	0.011 λ , 5.7 Ω	W1 = 16.51, W2 = 1.83, W3 = 16.51, W4 = 1.83	W1 = W1, W2 = 72, W3 = 650, W4 = 72
TL228	0.021 λ , 16.5 Ω	W1 = 5.08, W2 = 5.08, W3 = 3.81	W1 = 200, W2 = 200, W3 = 150
TL230	0.006 λ , 51.5 Ω	W = 1.10, L = 1.14	W = 44, L = 45
TL231	0.060 λ , 51.5 Ω	W = 1.10, L = 11.3	W = 44, L = 445
TL232	0.027 λ , 51.5 Ω	W = 1.10, L = 5.08	W = 44, L = 200
TL233	0.006 λ , 51.5 Ω	W = 1.10, L = 1.12	W = 44, L = 44
TL234	0.041 λ , 20.9 Ω	W = 3.81, L = 7.29	W = 150, L = 287
TL235	0.010 λ , 51.5 Ω	W1 = 1.10, W2 = 1.10, W3 = 1.91	W1 = 44, W2 = 44, W3 = 75
TL236	0.014 λ , 20.9 Ω	W = 3.81, L = 2.51	W = 150, L = 99
TL237	0.052 λ , 5.7 Ω	W = 16.51, L = 8.89	W = 650, L = 350
TL238	0.021 λ , 16.5 Ω	W1 = 5.08, W2 = 5.08, W3 = 3.81	W1 = 200, W2 = 200, W3 = 150
TL239	0.021 λ , 20.9 Ω	W1 = 3.81, W2 = 3.81, W3 = 3.81	W1 = 150, W2 = 150, W3 = 150
TL240	0.007 l, 20.9 W	W1 = 3.81, W2 = 3.81, W3 = 1.27	W1 = 150, W2 = 150, W3 = 50



Reference Circuit (cont.)

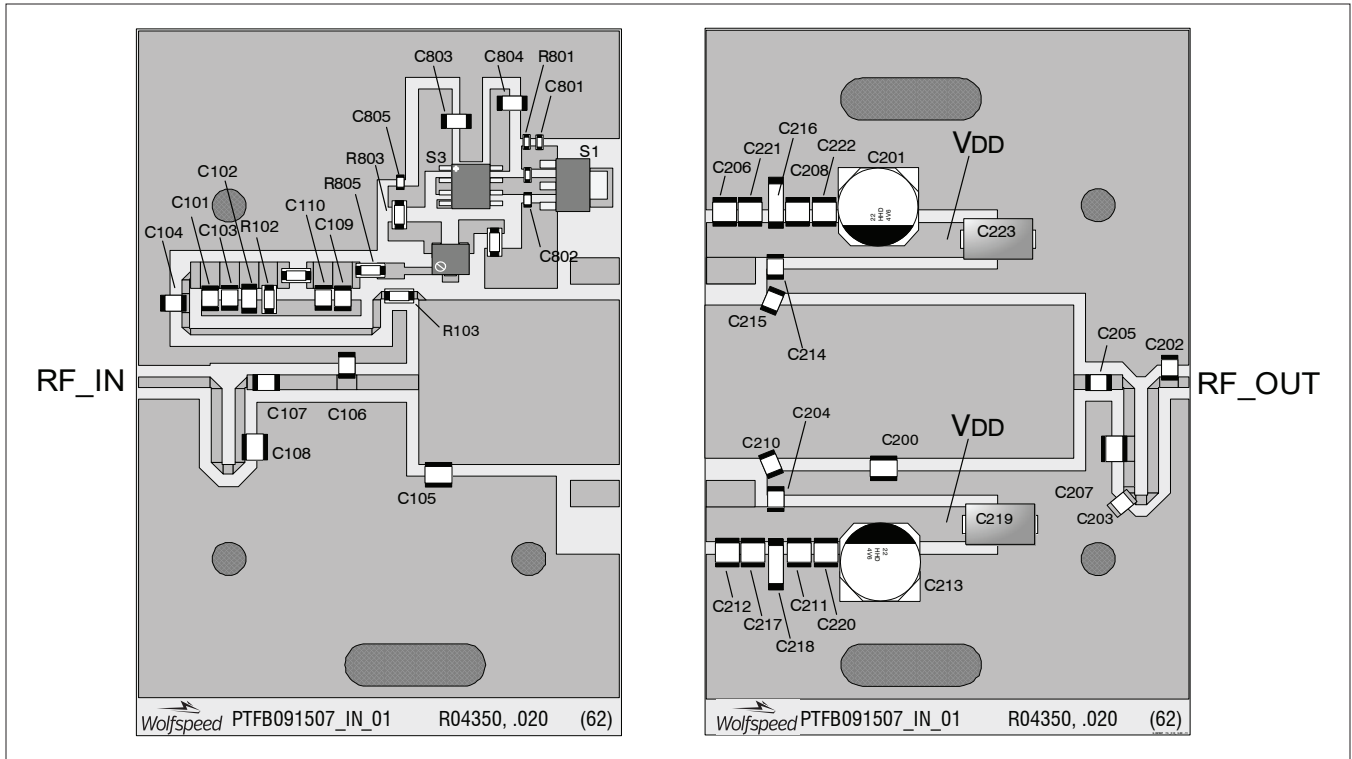

Reference circuit board layout (not to scale)

Component	Description	Suggested Supplier	P/N or Comment
C101	Chip capacitor, 33 pF	ATC	ATC100B330JW500XB
C102	Chip capacitor, 4.71 μ F	Digi-Key	493-2372-2-ND
C103	Capacitor, 10 nF	ATC	ATC200B103MW50XC
C104, C107	Chip capacitor, 56 pF	ATC	ATC100B560JW500XB
C105	Chip capacitor, 3.3 pF	ATC	ATC100B3R3CW500XB
C106, C203	Chip capacitor, 3.9 pF	ATC	ATC100B3R9CW500XB
C108	Chip capacitor, 1.5 pF	ATC	ATC100B1R5CW500XB
C109	Capacitor, 10 nF	ATC	ATC200B103MW50XC
C110	Chip capacitor, 4.7 pF	ATC	ATC100B4R7CW500XB
C201, C213	Electrolytic cap., 100 μ F, 50 V	Digi-Key	PCE4442TR-ND
C202	Chip capacitor, 1.2 pF	ATC	ATC100B1R2CW500XB
C204	Capacitor, 10 nF	ATC	ATC200B103MW50XC
C205	Chip capacitor, 56 pF	ATC	ATC100B560JW500XB
C206, C208, C211, C212, C217, C220, C221, C222	Capacitor, 10 μ F	Digi-Key	587-1818-2-ND
C207	Chip capacitor, 0.2 pF	ATC	ATC100B0R2CW500XB
C209	Chip capacitor, 5.6 pF	ATC	ATC100B5R6CW500XB
C210	Chip capacitor, 1 pF	ATC	ATC100B1R0CW500XB

table continued on next page

Reference Circuit (cont.)

Component	Description	Suggested Supplier	P/N or Comment
C214	Capacitor, 10 nF	ATC	ATC200B103MW50XC
C215	Chip capacitor, 1 pF	ATC	ATC100B1R0CW500XB
C216, C218	Chip capacitor, 1 μ F	Digi-Key	478-3993-2-ND
C219, C223	Tantalum capacitor, 10 μ F, 35 V	Garrett Electronics	281M5002106K
C801, C803, C804	Chip capacitor, 1 nF	Digi-Key	PCC1772CT-ND
C802, 805	Chip capacitor, 100 nF	Digi-Key	PCC104BCT-ND
R101	Resistor, 10 Ω	Digi-Key	P10ECT-ND
R102	Resistor, 5.1 Ω	Digi-Key	P5.1KECT-ND
R103	Resistor, 10 Ω	Digi-Key	P10ECT-ND
R801	Resistor, 1.3k Ω	Digi-Key	P1.3KGCT-ND
R802	Resistor, 1.2k Ω	Digi-Key	P1.2KGCT-ND
R803, R805	Resistor, 10 Ω	Digi-Key	P10ECT-ND
R804	Resistor, 2k Ω	Digi-Key	P2.0KECT-ND
S1	Transistor	Digi-Key	BCP5616-ND
S2	Potentiometer, 2k Ω	Digi-Key	3224W-202ECT-ND
S3	Voltage regulator	Digi-Key	LM78L05ACM-ND

See package outline specifications on next page

Revision History

Revision	Date	Data Sheet Type	Page	Subjects (major changes at each revision)
03.1	2016-06-09	Production	2	Updated ordering code to R0
04	2018-06-22	Production	All	Converted to Wolfspeed Data Sheet

For more information, please contact:

4600 Silicon Drive
Durham, North Carolina, USA 27703
www.wolfspeed.com/RF

Sales Contact
RFSales@wolfspeed.com

RF Product Marketing Contact
RFMarketing@wolfspeed.com
919.407.7816

Notes

Disclaimer

Specifications are subject to change without notice. Cree, Inc. believes the information contained within this data sheet to be accurate and reliable. However, no responsibility is assumed by Cree for any infringement of patents or other rights of third parties which may result from its use. No license is granted by implication or otherwise under any patent or patent rights of Cree. Cree makes no warranty, representation or guarantee regarding the suitability of its products for any particular purpose. "Typical" parameters are the average values expected by Cree in large quantities and are provided for information purposes only. These values can and do vary in different applications and actual performance can vary over time. All operating parameters should be validated by customer's technical experts for each application. Cree products are not designed, intended or authorized for use as components in applications intended for surgical implant into the body or to support or sustain life, in applications in which the failure of the Cree product could result in personal injury or death or in applications for planning, construction, maintenance or direct operation of a nuclear facility.



Компания «ЭлектроПласт» предлагает заключение долгосрочных отношений при поставках импортных электронных компонентов на взаимовыгодных условиях!

Наши преимущества:

- Оперативные поставки широкого спектра электронных компонентов отечественного и импортного производства напрямую от производителей и с крупнейших мировых складов;
- Поставка более 17-ти миллионов наименований электронных компонентов;
- Поставка сложных, дефицитных, либо снятых с производства позиций;
- Оперативные сроки поставки под заказ (от 5 рабочих дней);
- Экспресс доставка в любую точку России;
- Техническая поддержка проекта, помощь в подборе аналогов, поставка прототипов;
- Система менеджмента качества сертифицирована по Международному стандарту ISO 9001;
- Лицензия ФСБ на осуществление работ с использованием сведений, составляющих государственную тайну;
- Поставка специализированных компонентов (Xilinx, Altera, Analog Devices, Intersil, Interpoint, Microsemi, Aeroflex, Peregrine, Syfer, Eurofarad, Texas Instrument, Miteq, Cobham, E2V, MA-COM, Hittite, Mini-Circuits, General Dynamics и др.);

Помимо этого, одним из направлений компании «ЭлектроПласт» является направление «Источники питания». Мы предлагаем Вам помощь Конструкторского отдела:

- Подбор оптимального решения, техническое обоснование при выборе компонента;
- Подбор аналогов;
- Консультации по применению компонента;
- Поставка образцов и прототипов;
- Техническая поддержка проекта;
- Защита от снятия компонента с производства.



Как с нами связаться

Телефон: 8 (812) 309 58 32 (многоканальный)

Факс: 8 (812) 320-02-42

Электронная почта: org@eplast1.ru

Адрес: 198099, г. Санкт-Петербург, ул. Калинина, дом 2, корпус 4, литера А.