

HEF40106B-Q100

Hex inverting Schmitt trigger

Rev. 1 — 7 August 2012

Product data sheet

1. General description

The HEF40106B-Q100 provides six inverting buffers. Each input has a Schmitt trigger circuit. The inverting buffer switches at different points for positive-going and negative-going signals. The difference between the positive voltage (V_{T+}) and the negative voltage (V_{T-}) is defined as hysteresis voltage (V_H).

The HEF40106B-Q100 may be used for enhanced noise immunity or to “square up” slowly changing waveforms.

It operates over a recommended V_{DD} power supply range of 3 V to 15 V referenced to V_{SS} (usually ground). Unused inputs must be connected to V_{DD} , V_{SS} , or another input.

This product has been qualified to the Automotive Electronics Council (AEC) standard Q100 (Grade 1) and is suitable for use in automotive applications.

2. Features and benefits

- Automotive product qualification in accordance with AEC-Q100 (Grade 1)
 - ◆ Specified from $-40\text{ }^{\circ}\text{C}$ to $+85\text{ }^{\circ}\text{C}$ and from $-40\text{ }^{\circ}\text{C}$ to $+125\text{ }^{\circ}\text{C}$
- Schmitt trigger input discrimination
- Fully static operation
- 5 V, 10 V, and 15 V parametric ratings
- Standardized symmetrical output characteristics
- ESD protection:
 - ◆ MIL-STD-883C, method 3015 exceeds 2000 V
 - ◆ HBM JESD22-A114F exceeds 2000 V
 - ◆ MM JESD22-A115-A exceeds 200 V ($C = 200\text{ pF}$, $R = 0\text{ }\Omega$)
- Complies with JEDEC standard JESD 13-B

3. Applications

- Wave and pulse shapers
- Astable multivibrators
- Monostable multivibrators

4. Ordering information

Table 1. Ordering information

All types operate from -40°C to $+125^{\circ}\text{C}$

| Type number | Package | | |
|------------------|---------|--|----------|
| | Name | Description | Version |
| HEF40106BT-Q100 | SO14 | plastic small outline package; 14 leads; body width 3.9 mm | SOT108-1 |
| HEF40106BTT-Q100 | TSSOP14 | plastic thin shrink small outline package; 14 leads; body width 4.4 mm | SOT402-1 |

5. Functional diagram

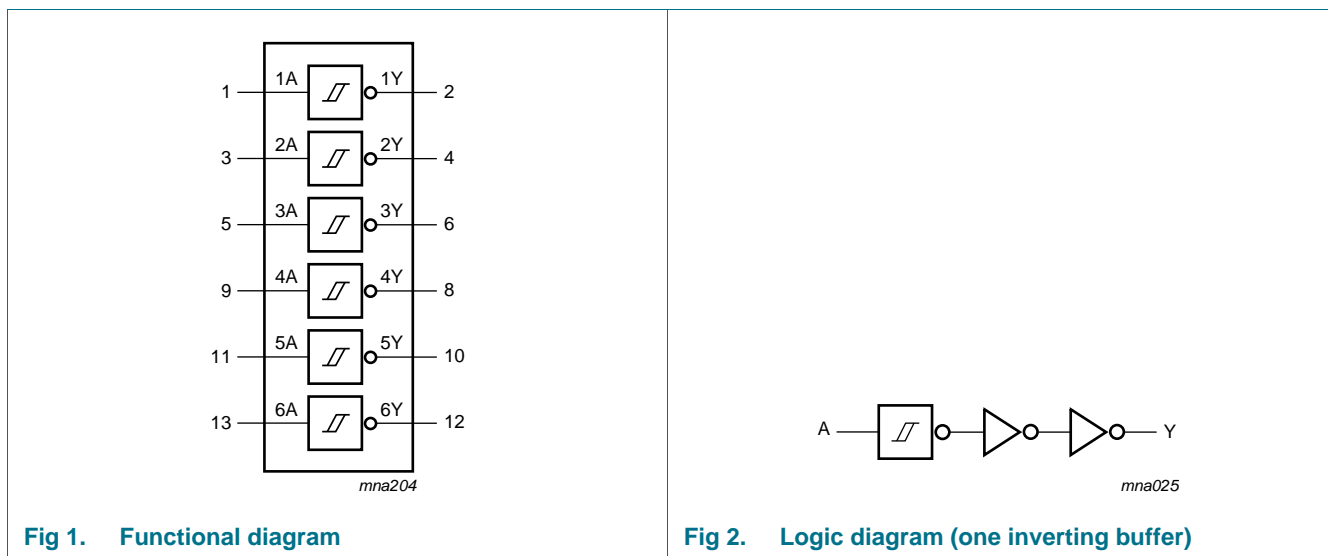

6. Pinning information

6.1 Pinning

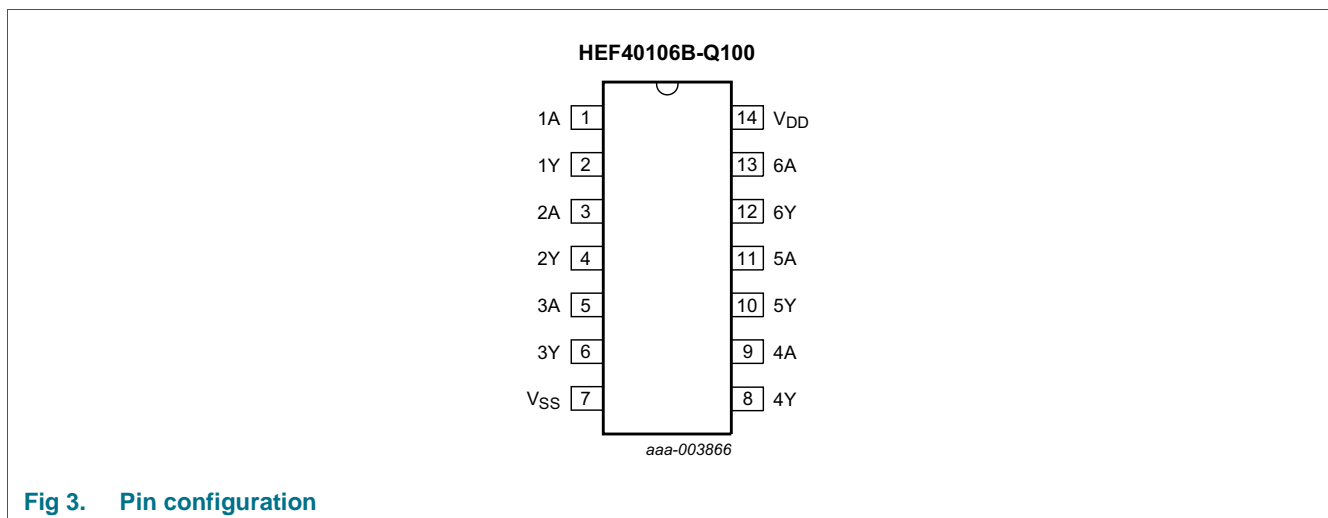

Fig 3. Pin configuration

6.2 Pin description

Table 2. Pin description

| Symbol | Pin | Description |
|-----------------|--------------------|----------------|
| 1A to 6A | 1, 3, 5, 9, 11, 13 | input |
| 1Y to 6Y | 2, 4, 6, 8, 10, 12 | output |
| V _{DD} | 14 | supply voltage |
| V _{SS} | 7 | ground (0 V) |

7. Functional description

Table 3. Function table^[1]

| Input | Output |
|-------|--------|
| nA | nY |
| L | H |
| H | L |

[1] H = HIGH voltage level; L = LOW voltage level.

8. Limiting values

Table 4. Limiting values

In accordance with the Absolute Maximum Rating System (IEC 60134). Voltages are referenced to V_{SS} = 0 V (ground).

| Symbol | Parameter | Conditions | Min | Max | Unit |
|------------------|-------------------------|---|------------------|-----------------------|------|
| V _{DD} | supply voltage | | -0.5 | +18 | V |
| I _{IK} | input clamping current | V _I < -0.5 V or V _I > V _{DD} + 0.5 V | - | ±10 | mA |
| V _I | input voltage | | -0.5 | V _{DD} + 0.5 | V |
| I _{OK} | output clamping current | V _O < -0.5 V or V _O > V _{DD} + 0.5 V | - | ±10 | mA |
| I _{I/O} | input/output current | | - | ±10 | mA |
| I _{DD} | supply current | | - | 50 | mA |
| T _{stg} | storage temperature | | -65 | +150 | °C |
| T _{amb} | ambient temperature | | -40 | +125 | °C |
| P _{tot} | total power dissipation | T _{amb} = -40 °C to +125 °C | | | |
| | | SO14 | ^[1] - | 500 | mW |
| | | TSSOP14 | ^[2] - | 500 | mW |
| P | power dissipation | per output | - | 100 | mW |

[1] For SO14 packages: above T_{amb} = 70 °C, P_{tot} derates linearly with 8 mW/K.

[2] For TSSOP14 packages: above T_{amb} = 60 °C, P_{tot} derates linearly with 5.5 mW/K.

9. Recommended operating conditions

Table 5. Recommended operating conditions

| Symbol | Parameter | Conditions | Min | Max | Unit |
|-----------|---------------------|-------------|-----|----------|------|
| V_{DD} | supply voltage | | 3 | 15 | V |
| V_I | input voltage | | 0 | V_{DD} | V |
| T_{amb} | ambient temperature | in free air | -40 | +125 | °C |

10. Static characteristics

Table 6. Static characteristics

$V_{SS} = 0$ V; $V_I = V_{SS}$ or V_{DD} ; unless otherwise specified.

| Symbol | Parameter | Conditions | V_{DD} | $T_{amb} = -40$ °C | | $T_{amb} = +25$ °C | | $T_{amb} = +85$ °C | | $T_{amb} = +125$ °C | | Unit |
|----------|---------------------------|--|----------|--------------------|-----------|--------------------|-----------|--------------------|-----------|---------------------|-----------|---------|
| | | | | Min | Max | Min | Max | Min | Max | Min | Max | |
| V_{OH} | HIGH-level output voltage | $ I_O < 1$ μ A | 5 V | 4.95 | - | 4.95 | - | 4.95 | - | 4.95 | - | V |
| | | | 10 V | 9.95 | - | 9.95 | - | 9.95 | - | 9.95 | - | V |
| | | | 15 V | 14.95 | - | 14.95 | - | 14.95 | - | 14.95 | - | V |
| V_{OL} | LOW-level output voltage | $ I_O < 1$ μ A | 5 V | - | 0.05 | - | 0.05 | - | 0.05 | - | 0.05 | V |
| | | | 10 V | - | 0.05 | - | 0.05 | - | 0.05 | - | 0.05 | V |
| | | | 15 V | - | 0.05 | - | 0.05 | - | 0.05 | - | 0.05 | V |
| I_{OH} | HIGH-level output current | $V_O = 2.5$ V | 5 V | - | -1.7 | - | -1.4 | - | -1.1 | - | -1.1 | mA |
| | | $V_O = 4.6$ V | 5 V | - | -0.64 | - | -0.5 | - | -0.36 | - | -0.36 | mA |
| | | $V_O = 9.5$ V | 10 V | - | -1.6 | - | -1.3 | - | -0.9 | - | -0.9 | mA |
| | | $V_O = 13.5$ V | 15 V | - | -4.2 | - | -3.4 | - | -2.4 | - | -2.4 | mA |
| I_{OL} | LOW-level output current | $V_O = 0.4$ V | 5 V | 0.64 | - | 0.5 | - | 0.36 | - | 0.36 | - | mA |
| | | $V_O = 0.5$ V | 10 V | 1.6 | - | 1.3 | - | 0.9 | - | 0.9 | - | mA |
| | | $V_O = 1.5$ V | 15 V | 4.2 | - | 3.4 | - | 2.4 | - | 2.4 | - | mA |
| I_I | input leakage current | | 15 V | - | ± 0.1 | - | ± 0.1 | - | ± 1.0 | - | ± 1.0 | μ A |
| I_{DD} | supply current | all valid input combinations; $I_O = 0$ A | 5 V | - | 0.25 | - | 0.25 | - | 7.5 | - | 7.5 | μ A |
| | | | 10 V | - | 0.5 | - | 0.5 | - | 15.0 | - | 15.0 | μ A |
| | | | 15 V | - | 1.0 | - | 1.0 | - | 30.0 | - | 30.0 | μ A |
| C_I | input capacitance | | | - | - | - | 7.5 | - | - | - | pF | |

11. Dynamic characteristics

Table 7. Dynamic characteristics

$T_{amb} = 25\text{ }^{\circ}\text{C}$; $C_L = 50\text{ pF}$; $t_r = t_f \leq 20\text{ ns}$; wave forms see [Figure 4](#); test circuit see [Figure 5](#); unless otherwise specified.

| Symbol | Parameter | Conditions | V _{DD} | Extrapolation formula ^[1] | Min | Typ | Max | Unit |
|------------------|------------------------------------|------------------|-----------------|--------------------------------------|-----|-----|-----|------|
| t _{PHL} | HIGH to LOW propagation delay | nA or nB to nY | 5 V | 63 ns + (0.55 ns/pF)C _L | - | 90 | 180 | ns |
| | | | 10 V | 29 ns + (0.23 ns/pF)C _L | - | 35 | 70 | ns |
| | | | 15 V | 22 ns + (0.16 ns/pF)C _L | - | 30 | 60 | ns |
| t _{PLH} | LOW to HIGH propagation delay | nA or nB to nY | 5 V | 58 ns + (0.55 ns/pF)C _L | - | 75 | 150 | ns |
| | | | 10 V | 29 ns + (0.23 ns/pF)C _L | - | 35 | 70 | ns |
| | | | 15 V | 22 ns + (0.16 ns/pF)C _L | - | 30 | 60 | ns |
| t _{THL} | HIGH to LOW output transition time | nY to LOW | 5 V | 10 ns + (1.00 ns/pF)C _L | - | 60 | 120 | ns |
| | | | 10 V | 9 ns + (0.42 ns/pF)C _L | - | 30 | 60 | ns |
| | | | 15 V | 6 ns + (0.28 ns/pF)C _L | - | 20 | 40 | ns |
| t _{TLH} | LOW to HIGH output transition time | nA or nB to HIGH | 5 V | 10 ns + (1.00 ns/pF)C _L | - | 60 | 120 | ns |
| | | | 10 V | 9 ns + (0.42 ns/pF)C _L | - | 30 | 60 | ns |
| | | | 15 V | 6 ns + (0.28 ns/pF)C _L | - | 20 | 40 | ns |

[1] Typical value of the propagation delay and output transition time can be calculated with the extrapolation formula (C_L in pF).

Table 8. Dynamic power dissipation

$V_{SS} = 0\text{ V}$; $t_r = t_f \leq 20\text{ ns}$; $T_{amb} = 25\text{ }^{\circ}\text{C}$.

| Symbol | Parameter | V _{DD} | Typical formula | where: |
|----------------|---------------------------|-----------------|--|--|
| P _D | dynamic power dissipation | 5 V | $P_D = 2300 \times f_i + \Sigma(f_o \times C_L) \times V_{DD}^2$ (μW) | f _i = input frequency in MHz; |
| | | 10 V | $P_D = 9000 \times f_i + \Sigma(f_o \times C_L) \times V_{DD}^2$ (μW) | f _o = output frequency in MHz; |
| | | 15 V | $P_D = 20000 \times f_i + \Sigma(f_o \times C_L) \times V_{DD}^2$ (μW) | C _L = output load capacitance in pF; Σ(f _o × C _L) = sum of the outputs; V _{DD} = supply voltage in V. |

12. Waveforms

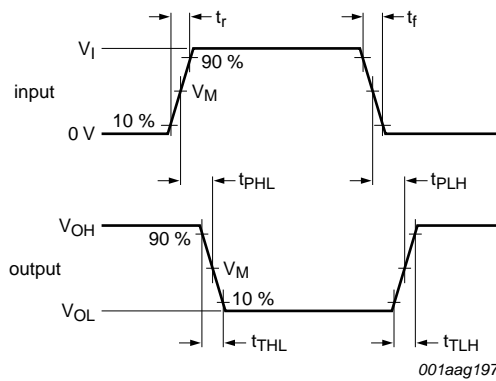

Measurement points are given in [Table 9](#).
 Logic levels: V_{OL} and V_{OH} are typical output voltage levels that occur with the output load.
 t_r , t_f = input rise and fall times.

Fig 4. Propagation delay and output transition time

Table 9. Measurement points

| Supply voltage | Input | Output |
|----------------|-------------|-------------|
| V_{DD} | V_M | V_M |
| 5 V to 15 V | $0.5V_{DD}$ | $0.5V_{DD}$ |

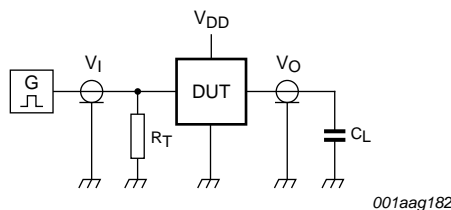

Test data given in [Table 10](#).
 Definitions for test circuit:
 DUT = Device Under Test.
 C_L = load capacitance including jig and probe capacitance.
 R_T = termination resistance should be equal to the output impedance Z_o of the pulse generator.

Fig 5. Test circuit

Table 10. Test data

| Supply voltage | Input | Load |
|----------------|----------------------|--------------|
| V_{DD} | V_I | C_L |
| 5 V to 15 V | V_{SS} or V_{DD} | ≤ 20 ns |
| | | 50 pF |

13. Transfer characteristics

Table 11. Transfer characteristics

$V_{SS} = 0\text{ V}$; see [Figure 6](#) and [Figure 7](#).

| Symbol | Parameter | Conditions | V_{DD} | $T_{amb} = -40\text{ °C to }+85\text{ °C}$ | | | $T_{amb} = -40\text{ °C to }+125\text{ °C}$ | | Unit |
|----------|----------------------------------|------------|----------|--|--------------------|------|---|------|------|
| | | | | Min | Typ ^[1] | Max | Min | Max | |
| V_{T+} | positive-going threshold voltage | | 5 V | 2.0 | 3.0 | 3.5 | 2.0 | 3.5 | V |
| | | | 10 V | 3.7 | 5.8 | 7.0 | 3.7 | 7.0 | V |
| | | | 15 V | 4.9 | 8.3 | 11.0 | 4.9 | 11.0 | V |
| V_{T-} | negative-going threshold voltage | | 5 V | 1.5 | 2.2 | 3.0 | 1.5 | 3.0 | V |
| | | | 10 V | 3.0 | 4.5 | 6.3 | 3.0 | 6.3 | V |
| | | | 15 V | 4.0 | 6.5 | 10.1 | 4.0 | 10.1 | V |
| V_H | hysteresis voltage | | 5 V | 0.5 | 0.8 | - | 0.5 | - | V |
| | | | 10 V | 0.7 | 1.3 | - | 0.7 | - | V |
| | | | 15 V | 0.9 | 1.8 | - | 0.9 | - | V |

[1] All typical values are at $T_{amb} = 25\text{ °C}$.

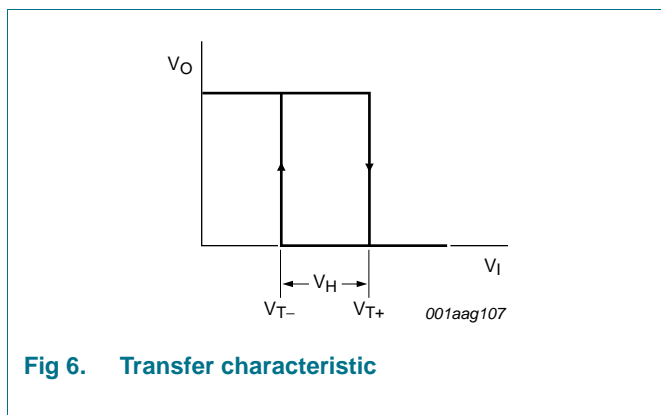

Fig 6. Transfer characteristic

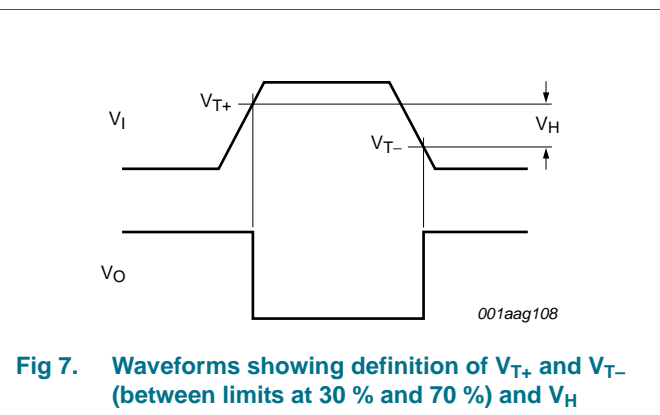
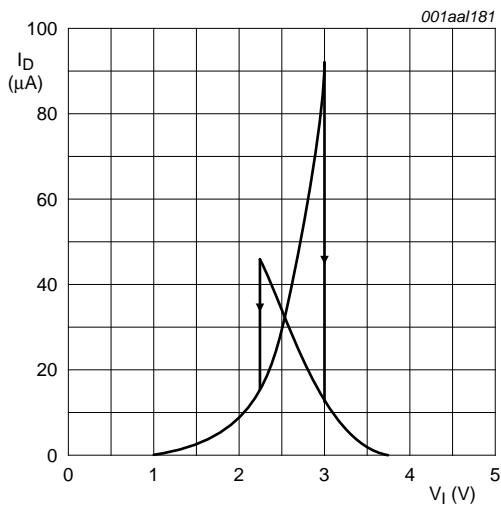
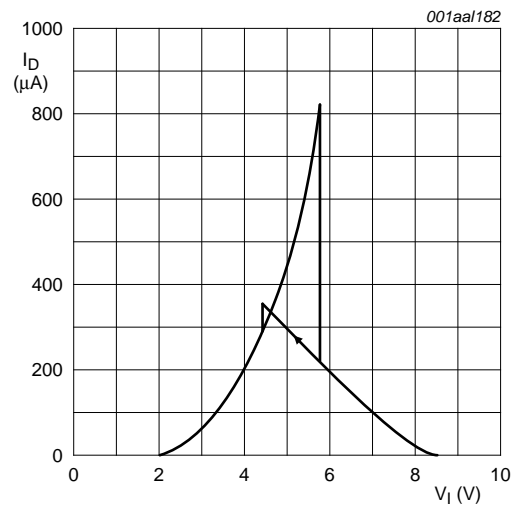

Fig 7. Waveforms showing definition of V_{T+} and V_{T-} (between limits at 30% and 70%) and V_H



a. $V_{DD} = 5\text{ V}$; $T_{amb} = 25\text{ }^\circ\text{C}$



b. $V_{DD} = 10\text{ V}$; $T_{amb} = 25\text{ }^\circ\text{C}$

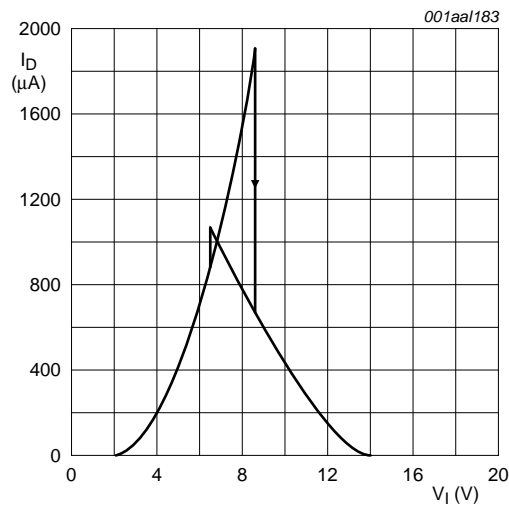

c. $V_{DD} = 15\text{ V}$; $T_{amb} = 25\text{ }^\circ\text{C}$

Fig 8. Typical drain current as a function of input

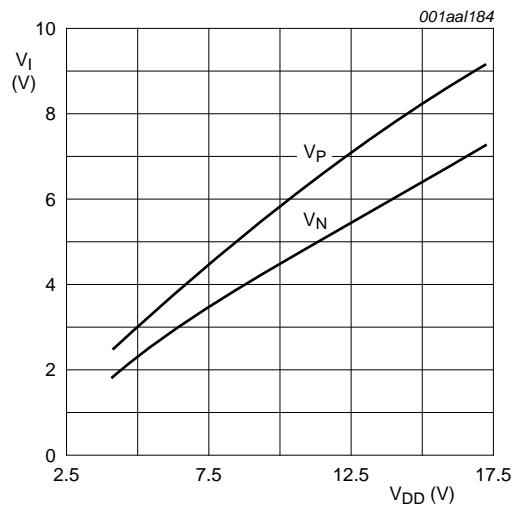

T_{amb} = 25 °C.

Fig 9. Typical switching levels as a function of supply voltage

14. Application information

Some examples of applications for the HEF40106B-Q100 are:

- Wave and pulse shapers
- Astable multivibrators
- Monostable multivibrators

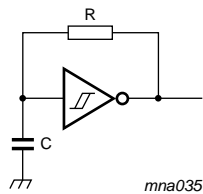

Fig 10. Astable multivibrator

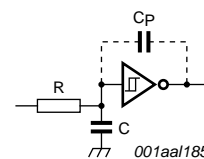

Fig 11. Schmitt trigger driven via a high-impedance input

If a Schmitt trigger is driven via a high-impedance ($R > 1 \text{ k}\Omega$), then it is necessary to incorporate a capacitor C with a value of $\frac{C}{C_P} > \frac{V_{DD} - V_{SS}}{V_H}$; otherwise oscillation can occur on the edges of a pulse.

C_P is the external parasitic capacitance between inputs and output; the value depends on the circuit board layout.

15. Package outline

SO14: plastic small outline package; 14 leads; body width 3.9 mm

SOT108-1

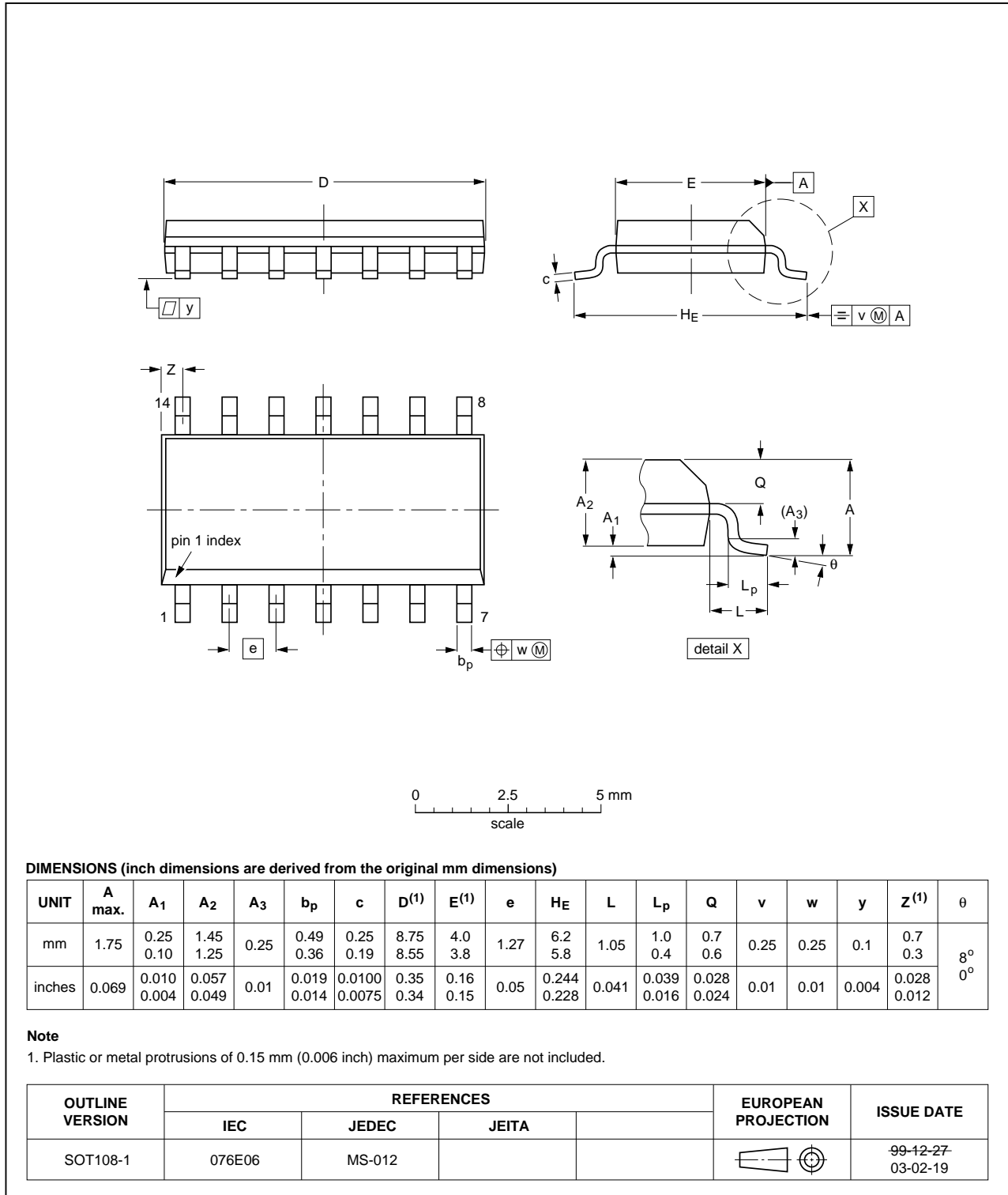

Fig 12. Package outline SOT108-1 (SO14)

TSSOP14: plastic thin shrink small outline package; 14 leads; body width 4.4 mm

SOT402-1

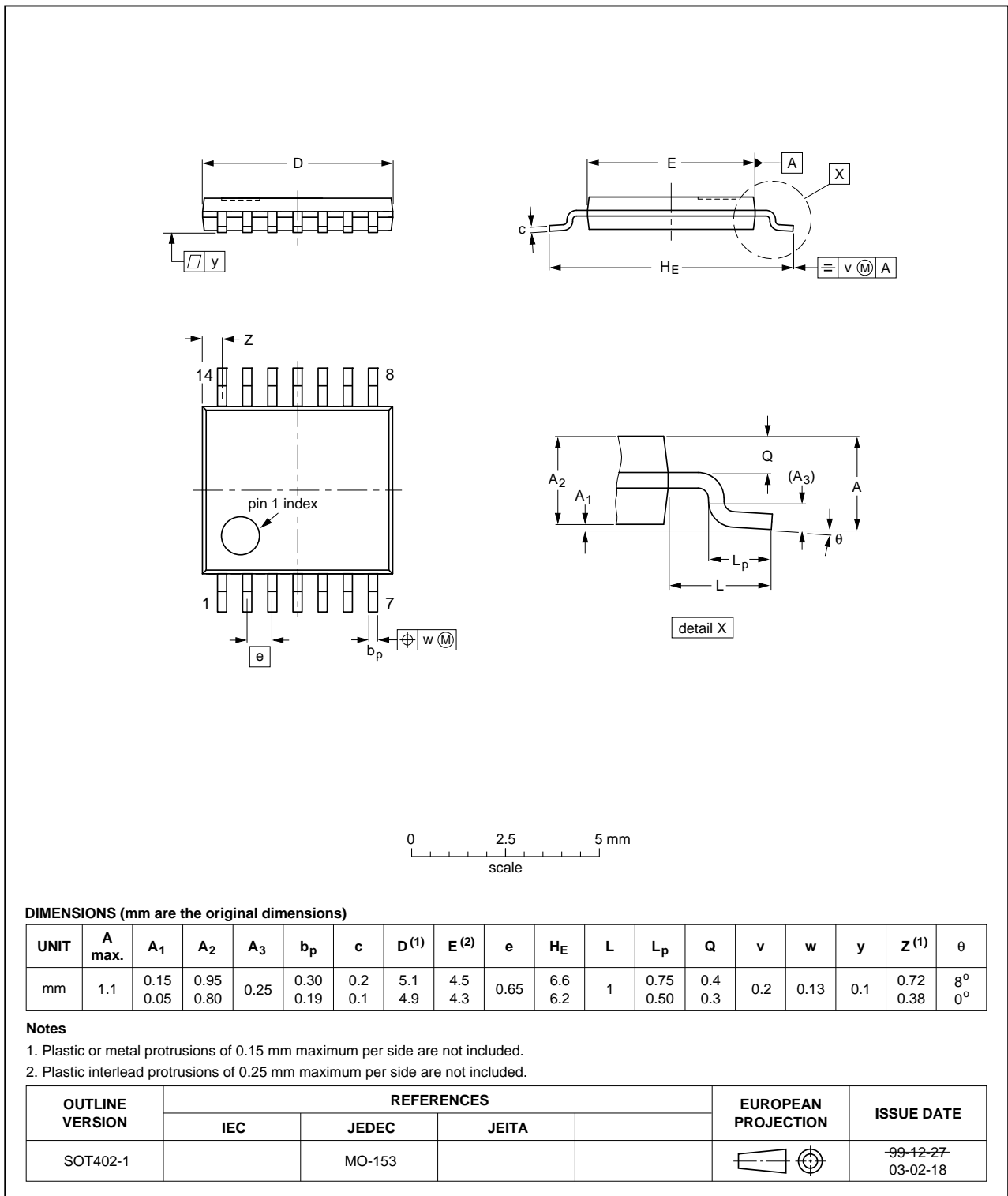

Fig 13. Package outline SOT402-1 (TSSOP14)

16. Abbreviations

Table 12. Abbreviations

| Acronym | Description |
|---------|-------------------------|
| HBM | Human Body Model |
| ESD | ElectroStatic Discharge |
| MM | Machine Model |
| MIL | Military |

17. Revision history

Table 13. Revision history

| Document ID | Release date | Data sheet status | Change notice | Supersedes |
|--------------------|--------------|--------------------|---------------|------------|
| HEF40106B_Q100 v.1 | 20120807 | Product data sheet | - | - |

18. Legal information

18.1 Data sheet status

| Document status ^{[1][2]} | Product status ^[3] | Definition |
|-----------------------------------|-------------------------------|---|
| Objective [short] data sheet | Development | This document contains data from the objective specification for product development. |
| Preliminary [short] data sheet | Qualification | This document contains data from the preliminary specification. |
| Product [short] data sheet | Production | This document contains the product specification. |

[1] Please consult the most recently issued document before initiating or completing a design.

[2] The term 'short data sheet' is explained in section "Definitions".

[3] The product status of device(s) described in this document may have changed since this document was published and may differ in case of multiple devices. The latest product status information is available on the Internet at URL <http://www.nexperia.com>.

18.2 Definitions

Draft — The document is a draft version only. The content is still under internal review and subject to formal approval, which may result in modifications or additions. Nexperia does not give any representations or warranties as to the accuracy or completeness of information included herein and shall have no liability for the consequences of use of such information.

Short data sheet — A short data sheet is an extract from a full data sheet with the same product type number(s) and title. A short data sheet is intended for quick reference only and should not be relied upon to contain detailed and full information. For detailed and full information see the relevant full data sheet, which is available on request via the local Nexperia sales office. In case of any inconsistency or conflict with the short data sheet, the full data sheet shall prevail.

Product specification — The information and data provided in a Product data sheet shall define the specification of the product as agreed between Nexperia and its customer, unless Nexperia and customer have explicitly agreed otherwise in writing. In no event however, shall an agreement be valid in which the Nexperia product is deemed to offer functions and qualities beyond those described in the Product data sheet.

18.3 Disclaimers

Limited warranty and liability — Information in this document is believed to be accurate and reliable. However, Nexperia does not give any representations or warranties, expressed or implied, as to the accuracy or completeness of such information and shall have no liability for the consequences of use of such information. Nexperia takes no responsibility for the content in this document if provided by an information source outside of Nexperia.

In no event shall Nexperia be liable for any indirect, incidental, punitive, special or consequential damages (including - without limitation - lost profits, lost savings, business interruption, costs related to the removal or replacement of any products or rework charges) whether or not such damages are based on tort (including negligence), warranty, breach of contract or any other legal theory.

Notwithstanding any damages that customer might incur for any reason whatsoever, Nexperia's aggregate and cumulative liability towards customer for the products described herein shall be limited in accordance with the *Terms and conditions of commercial sale* of Nexperia.

Right to make changes — Nexperia reserves the right to make changes to information published in this document, including without limitation specifications and product descriptions, at any time and without notice. This document supersedes and replaces all information supplied prior to the publication hereof.

Suitability for use in automotive applications — This Nexperia product has been qualified for use in automotive applications. Unless otherwise agreed in writing, the product is not designed, authorized or warranted to be suitable for use in life support, life-critical or safety-critical systems or equipment, nor in applications where failure or malfunction of a Nexperia product can reasonably be expected to result in personal injury, death or severe property or environmental damage. Nexperia and its suppliers accept no liability for inclusion and/or use of Nexperia products in such equipment or applications and therefore such inclusion and/or use is at the customer's own risk.

Applications — Applications that are described herein for any of these products are for illustrative purposes only. Nexperia makes no representation or warranty that such applications will be suitable for the specified use without further testing or modification.

Customers are responsible for the design and operation of their applications and products using Nexperia products, and Nexperia accepts no liability for any assistance with applications or customer product design. It is customer's sole responsibility to determine whether the Nexperia product is suitable and fit for the customer's applications and products planned, as well as for the planned application and use of customer's third party customer(s). Customers should provide appropriate design and operating safeguards to minimize the risks associated with their applications and products.

Nexperia does not accept any liability related to any default, damage, costs or problem which is based on any weakness or default in the customer's applications or products, or the application or use by customer's third party customer(s). Customer is responsible for doing all necessary testing for the customer's applications and products using Nexperia products in order to avoid a default of the applications and the products or of the application or use by customer's third party customer(s). Nexperia does not accept any liability in this respect.

Limiting values — Stress above one or more limiting values (as defined in the Absolute Maximum Ratings System of IEC 60134) will cause permanent damage to the device. Limiting values are stress ratings only and (proper) operation of the device at these or any other conditions above those given in the Recommended operating conditions section (if present) or the Characteristics sections of this document is not warranted. Constant or repeated exposure to limiting values will permanently and irreversibly affect the quality and reliability of the device.

Terms and conditions of commercial sale — Nexperia products are sold subject to the general terms and conditions of commercial sale, as published at <http://www.nexperia.com/profile/terms>, unless otherwise agreed in a valid written individual agreement. In case an individual agreement is concluded only the terms and conditions of the respective agreement shall apply. Nexperia hereby expressly objects to applying the customer's general terms and conditions with regard to the purchase of Nexperia products by customer.

No offer to sell or license — Nothing in this document may be interpreted or construed as an offer to sell products that is open for acceptance or the grant, conveyance or implication of any license under any copyrights, patents or other industrial or intellectual property rights.

Export control — This document as well as the item(s) described herein may be subject to export control regulations. Export might require a prior authorization from competent authorities.

Translations — A non-English (translated) version of a document is for reference only. The English version shall prevail in case of any discrepancy between the translated and English versions.

18.4 Trademarks

Notice: All referenced brands, product names, service names and trademarks are the property of their respective owners.

19. Contact information

For more information, please visit: <http://www.nexperia.com>

For sales office addresses, please send an email to: salesaddresses@nexperia.com

20. Contents

| | | |
|-----------|---|-----------|
| 1 | General description | 1 |
| 2 | Features and benefits | 1 |
| 3 | Applications | 1 |
| 4 | Ordering information | 2 |
| 5 | Functional diagram | 2 |
| 6 | Pinning information | 2 |
| 6.1 | Pinning | 2 |
| 6.2 | Pin description | 3 |
| 7 | Functional description | 3 |
| 8 | Limiting values | 3 |
| 9 | Recommended operating conditions | 4 |
| 10 | Static characteristics | 4 |
| 11 | Dynamic characteristics | 5 |
| 12 | Waveforms | 6 |
| 13 | Transfer characteristics | 7 |
| 14 | Application information | 9 |
| 15 | Package outline | 10 |
| 16 | Abbreviations | 12 |
| 17 | Revision history | 12 |
| 18 | Legal information | 13 |
| 18.1 | Data sheet status | 13 |
| 18.2 | Definitions | 13 |
| 18.3 | Disclaimers | 13 |
| 18.4 | Trademarks | 14 |
| 19 | Contact information | 14 |
| 20 | Contents | 15 |



Компания «ЭлектроПласт» предлагает заключение долгосрочных отношений при поставках импортных электронных компонентов на взаимовыгодных условиях!

Наши преимущества:

- Оперативные поставки широкого спектра электронных компонентов отечественного и импортного производства напрямую от производителей и с крупнейших мировых складов;
- Поставка более 17-ти миллионов наименований электронных компонентов;
- Поставка сложных, дефицитных, либо снятых с производства позиций;
- Оперативные сроки поставки под заказ (от 5 рабочих дней);
- Экспресс доставка в любую точку России;
- Техническая поддержка проекта, помощь в подборе аналогов, поставка прототипов;
- Система менеджмента качества сертифицирована по Международному стандарту ISO 9001;
- Лицензия ФСБ на осуществление работ с использованием сведений, составляющих государственную тайну;
- Поставка специализированных компонентов (Xilinx, Altera, Analog Devices, Intersil, Interpoint, Microsemi, Aeroflex, Peregrine, Syfer, Eurofarad, Texas Instrument, Miteq, Cobham, E2V, MA-COM, Hittite, Mini-Circuits, General Dynamics и др.);

Помимо этого, одним из направлений компании «ЭлектроПласт» является направление «Источники питания». Мы предлагаем Вам помощь Конструкторского отдела:

- Подбор оптимального решения, техническое обоснование при выборе компонента;
- Подбор аналогов;
- Консультации по применению компонента;
- Поставка образцов и прототипов;
- Техническая поддержка проекта;
- Защита от снятия компонента с производства.



Как с нами связаться

Телефон: 8 (812) 309 58 32 (многоканальный)

Факс: 8 (812) 320-02-42

Электронная почта: org@eplast1.ru

Адрес: 198099, г. Санкт-Петербург, ул. Калинина, дом 2, корпус 4, литера А.