PWM/VFM step-down DC/DC Controller

NO.EA-065-130424

OUTLINE

The R1223N Series are CMOS-based PWM step-down DC/DC Converter controllers with low supply current.

Each of these ICs consists of an oscillator, a PWM control circuit, a reference voltage unit, an error amplifier, a soft-start circuit, a protection circuit, a PWM/VFM alternative circuit, a chip enable circuit, and resistors for voltage detection. A low ripple, high efficiency step-down DC/DC converter can be easily composed of this IC with only four external components, or a power-transistor, an inductor, a diode and a capacitor.

With a PWM/VFM alternative circuit, when the load current is small, the operation is automatically switching into the VFM oscillator from PWM oscillator, therefore the efficiency at small load current is improved. The R1223NxxxB type, which is without a PWM/VFM alternative circuit, is also available.

If the term of maximum duty cycle keeps on a certain time, the embedded protection circuit works. There are two types of protection function. One is latch-type protection circuit, and it works to latch an external Power MOSFET with keeping it disable. To release the condition of protection, after disable this IC with a chip enable circuit, enable it again, or restart this IC with power-on. The other is Reset-type protection circuit, and it works to restart the operation with soft-start and repeat this operation until maximum duty cycle condition is released. Either of these protection circuits can be designated by users' request.

FEATURES

- Input Voltage Range 2.3V to 13.2V
- Output Voltage Range..... 1.5V to 5.0V (0.1V step)
- Output Voltage Accuracy..... ±2.0%
- Oscillator Frequency 300kHz, 500kHz
- High Efficiency Typ. 90%
- Standby Current Typ. 0μA
- Temperature-Drift Coefficient of Output Voltage Typ. ±100ppm/°C
- Built-in Soft-start Circuit
- Built-in Latch-type or Reset type Protection Circuit
- Package SOT-23-5

APPLICATION

- Power source for hand-held communication equipment, cameras, video instruments such as VCRs, camcorders.
- Power source for battery-powered equipment.
- Power source for household electrical appliances.

BLOCK DIAGRAM



SELECTION GUIDE

In the R1223N Series, the output voltage, the oscillator frequency, switching mode and type of short protection (Latch or Reset) for the IC are selectable at the user's request.

Product Name	Package	Quantity per Reel	Pb Free	Halogen Free
R1223Nxx2*-TR-FE	SOT-23-5	3,000pcs	Yes	Yes

xx : The output voltage can be designated in the range from 1.5V(15) to 5.0V(50) in 0.1V^{*1} steps.

* : Designation of the oscillator frequency, switching mode and type of short protection.

- A) 300kHz, with a PWM/VFM alternative circuit, Latch-type protection
- B) 500 kHz, with a PWM/VFM alternative circuit, Latch-type protection
- C) 300kHz, without a PWM/VFM alternative circuit, Latch-type protection
- D) 500kHz, without a PWM/VFM alternative circuit, Latch-type protection
- E) 300kHz, with a PWM/VFM alternative circuit, Reset-type protection
- F) 500 kHz, with a PWM/VFM alternative circuit, Reset-type protection
- G) 300kHz, without a PWM/VFM alternative circuit, Reset-type protection
- H) 500kHz, without a PWM/VFM alternative circuit, Reset-type protection

PIN CONFIGURATION



PIN DESCRIPTION

● SOT-23-5

Pin No	Symbol	Pin Description
1	CE	Chip Enable Pin
2	GND	Ground Pin Input Pin
3	V _{OUT}	Pin for Monitoring Output Voltage
4	EXT	External Transistor Drive Pin
5	V _{IN}	Power Supply Pin

ABSOLUTE MAXIMUM RATINGS

(GND=0V)

Symbol	Item	Rating	Unit
V _{IN}	V _{IN} Supply Voltage	15	V
V _{EXT}	EXT Pin Output Voltage	-0.3 to V _{IN} + 0.3	V
V _{CE}	CE Pin Input Voltage	-0.3 to V _{IN} + 0.3	V
V _{OUT}	V _{OUT} Pin Input Voltage	-0.3 to V _{IN} + 0.3	V
I _{EXT}	EXT Pin Inductor Drive Output Current	±25	mA
P _D	Power Dissipation (Standard Test Land Pattern)* ¹	420	mW
T _{opt}	Operating Temperature Range	-40 to 85	°C
T _{stg}	Storage Temperature Range	-55 to 125	°C

*¹ For Power Dissipation and Standard Test Land Pattern, please refer to PACKAGE INFORMATION.

ABSOLUTE MAXIMUM RATINGS

Electronic and mechanical stress momentarily exceeded absolute maximum ratings may cause the permanent damages and may degrade the life time and safety for both device and system using the device in the field. The functional operation at or over these absolute maximum ratings is not assured.

RECOMMENDED OPERATING CONDITIONS (ELECTRICAL CHARACTERISTICS)

All of electronic equipment should be designed that the mounted semiconductor devices operate within the recommended operating conditions. The semiconductor devices cannot operate normally over the recommended operating conditions, even if when they are used over such conditions by momentary electronic noise or surge. And the semiconductor devices may receive serious damage when they continue to operate over the recommended operating conditions.

ELECTRICAL CHARACTERISTICS

• R1223Nxx2A (,C,E,G) Output Voltage : Vo

(Topt=25°C)

Symbol	Item	Conditions	Min.	Typ.	Max.	Unit
V _{IN}	Operating Input Voltage		2.3		13.2	V
V _{OUT}	Step-down Output Voltage	V _{IN} =V _{CE} =V _O +1.2V, I _{OUT} =-10mA	V _O × 0.98	V _O	V _O × 1.02	V
ΔV _{OUT} /ΔT	Step-down Output Voltage Temperature Coefficient	-40°C ≤ Topt ≤ 85°C		±100		ppm/°C
fosc	Oscillator Frequency	V _{IN} =V _{CE} =V _O +1.2V, I _{OUT} =-100mA	240	300	360	kHz
Δfosc/ΔT	Oscillator Frequency Temperature Coefficient	-40°C ≤ Topt ≤ 85°C		±0.3		%/°C
I _{DD1}	Supply Current1	V _{IN} =13.2V, V _{CE} =13.2V, V _{OUT} =13.2V		100	160	μA
I _{stb}	Standby Current	V _{IN} =13.2V, V _{CE} =0V, V _{OUT} =0V		0.0	0.5	μA
I _{EXTH}	EXT “H” Output Current	V _{IN} =8V, V _{EXT} =7.9V, V _{OUT} =8V, V _{CE} =8V		-10	-6	mA
I _{EXTL}	EXT “L” Output Current	V _{IN} =8V, V _{EXT} =0.1V, V _{OUT} =0V, V _{CE} =8V	10	20		mA
I _{CEH}	CE “H” Input Current	V _{IN} =13.2V, V _{CE} =13.2V, V _{OUT} =13.2V		0.0	0.5	μA
I _{CEL}	CE “L” Input Current	V _{IN} =13.2V, V _{CE} =0V, V _{OUT} =13.2V	-0.5	0.0		μA
V _{CEH}	CE “H” Input Voltage	V _{IN} =8V, V _{OUT} =0V→1.5V		0.8	1.2	V
V _{CEL}	CE “L” Input Voltage	V _{IN} =8V, V _{OUT} =1.5V→0V	0.3	0.8		V
Maxdty	Oscillator Maximum Duty Cycle		100			%
VFMdty	VFM Duty Cycle	only for A, E version		25		%
T _{start}	Delay Time by Soft-Start function	V _{IN} = V _O +1.2V, V _{CE} =0V→V _O +1.2V specified at 80% for rising edge	5	10	16	ms
T _{prot}	Delay Time for protection circuit	V _{IN} =V _{CE} =V _O +1.2V V _{OUT} =V _O +1.2V→0V	1	3	5	ms

• R1223Nxx2B (,D,F,H) Output Voltage : Vo

(Topt=25°C)

Symbol	Item	Conditions	Min.	Typ.	Max.	Unit
V _{IN}	Operating Input Voltage		2.3		13.2	V
V _{OUT}	Step-down Output Voltage	V _{IN} =V _{CE} =V _O +1.2V, I _{OUT} =-10mA	V _O × 0.98	V _O	V _O × 1.02	V
ΔV _{OUT} /ΔT	Step-down Output Voltage Temperature Coefficient	-40°C ≤ Topt ≤ 85°C		±100		ppm/°C
Fosc	Oscillator Frequency	V _{IN} =V _{CE} =V _O +1.2V, I _{OUT} =-100mA	400	500	600	kHz
Δfosc/ΔT	Oscillator Frequency Temperature Coefficient	-40°C ≤ Topt ≤ 85°C		±0.3		%/°C
I _{DD1}	Supply Current1	V _{IN} =13.2V, V _{CE} =13.2V, V _{OUT} =13.2V		140	200	μA
I _{stb}	Standby Current	V _{IN} =13.2V, V _{CE} =0V, V _{OUT} =0V		0.0	0.5	μA
I _{EXTH}	EXT “H” Output Current	V _{IN} =8V, V _{EXT} =7.9V, V _{OUT} =8V, V _{CE} =8V		-10	-6	mA
I _{EXTL}	EXT “L” Output Current	V _{IN} =8V, V _{EXT} =0.1V, V _{OUT} =0V, V _{CE} =8V	10	20		mA
I _{CEH}	CE “H” Input Current	V _{IN} =13.2V, V _{CE} =13.2V, V _{OUT} =13.2V		0.0	0.5	μA
I _{CEL}	CE “L” Input Current	V _{IN} =13.2V, V _{CE} =0V, V _{OUT} =13.2V	-0.5	0.0		μA
V _{CEH}	CE “H” Input Voltage	V _{IN} =8V, V _{OUT} =0V→1.5V		0.8	1.2	V
V _{CEL}	CE “L” Input Voltage	V _{IN} =8V, V _{OUT} =1.5V→0V	0.3	0.8		V
Maxdty	Oscillator Maximum Duty Cycle		100			%
VFMdty	VFM Duty Cycle	only for B, F version		25		%
T _{start}	Delay Time by Soft-Start function	V _{IN} =V _O +1.2V, V _{CE} =0V→V _O +1.2V specified at 80% for rising edge	3	6	10	ms
T _{prot}	Delay Time for protection circuit	V _{IN} =V _{CE} =V _O +1.2V V _{OUT} =V _O +1.2V→0V	1	2	4	ms

TEST CIRCUITS

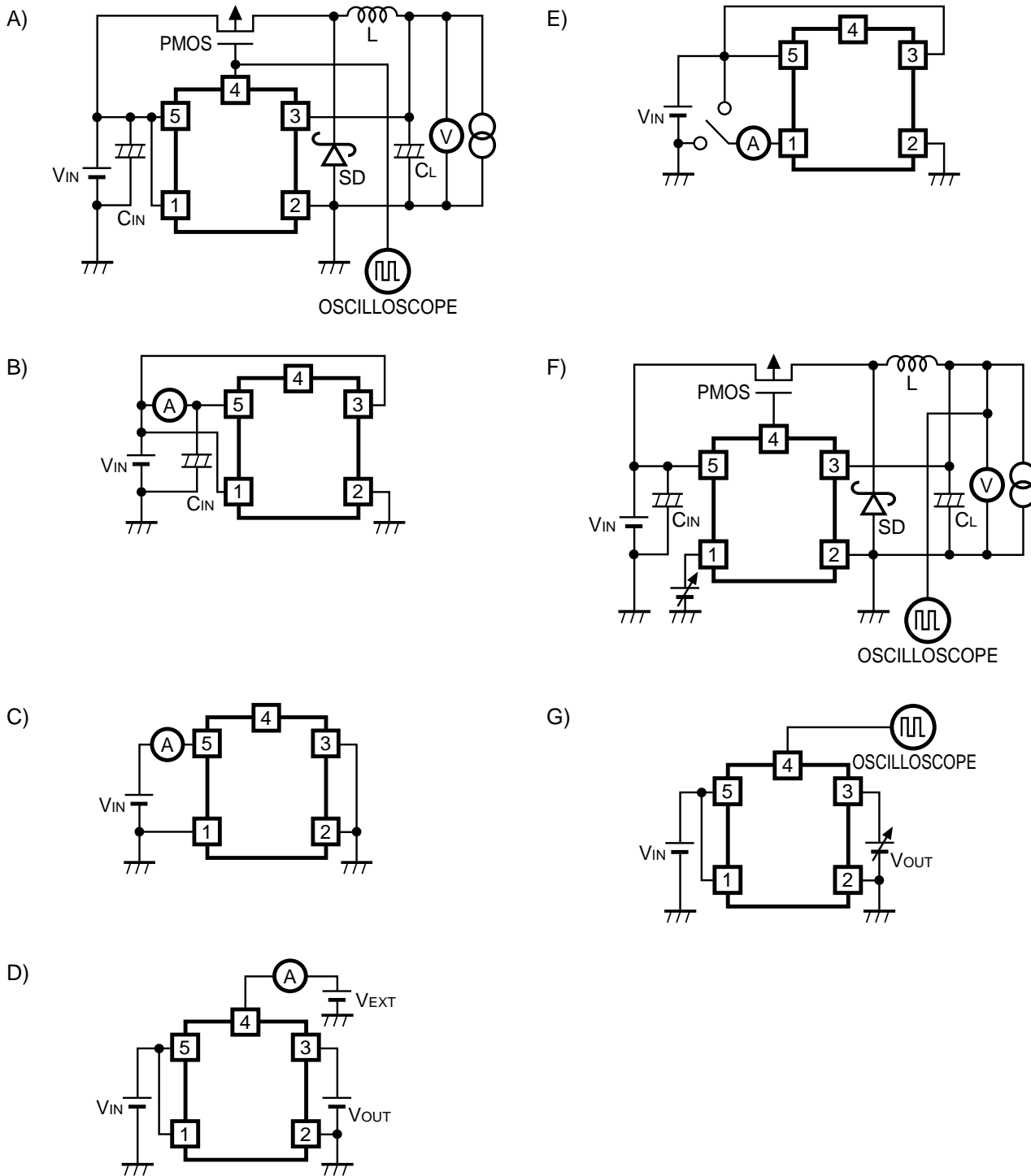

The typical characteristics were obtained by use of these test circuits.

Test Circuit A: Typical characteristics 1), 2), 3), 4), 5), 6), 7)

Test Circuit B: Typical characteristics 8)

Test Circuit C : Standby Current

Test Circuit D : Typical characteristics 12), 13)

Test Circuit E : CE input current "H" and "L"

Test Circuit F : Typical characteristics 9)

Test Circuit G : Typical characteristics 10), 11)

TYPICAL APPLICATIONS AND APPLICATION HINTS



PMOS : HAT1020R (Hitachi), Si3443DV (Siliconix) L : CD105 (Sumida, 27 μ H)

SD1 : RB491D (Rohm)

C_{OUT} : 47 μ F (Tantalum Type)

C_{IN} : 10 μ F \times 2 (Tantalum Type)

When you use these ICs, consider the following issues;

- As shown in the block diagram, a parasitic diode is formed in each terminal, each of these diodes is not formed for load current, therefore do not use it in such a way. When you control the CE pin by another power supply, do not make its “H” level more than the voltage level of V_{IN} pin.

- The operation of latch-type protection circuit is as follows;

When the maximum duty cycle continues longer than the delay time for protection circuit, (Refer to the Electrical Characteristics) the protection circuit works to shut-down Power MOSFET with its latching operation. Therefore when an input/output voltage difference is small, the protection circuit may work with small load current.

To release the protection latch state, after disable this IC with a chip enable circuit, enable it again, or restart this IC with power-on. However, in the case of restarting this IC with power-on, after the power supply is turned off, if a certain amount of charge remains in C_{IN} , or some voltage is forced to V_{IN} from C_{IN} , this IC might not be restarted even after power-on.

If rising transition speed of supply voltage is too slow, or the time which is required for V_{IN} voltage to reach Output voltage of DC/DC converter is longer than soft-starting time plus delay time for protection circuit, protection circuit works before V_{IN} voltage reaches Output voltage of DC/DC converter. To prevent this action, while power supply voltage is not ready, make this IC be standby mode (CE=“L”), and when the power supply is ready (the voltage level of V_{IN} is equal or more than the voltage level of V_{OUT}), make it enable (CE=“H”).

- The operation of Reset-type protection circuit is as follows;

When the maximum duty cycle continues longer than the delay time for protection circuit, (Refer to the Electrical Characteristics) the protection circuit works to restart with soft-start operation. Therefore when an input/output voltage difference is small, the protection circuit may work with small load current.

- Set external components as close as possible to the IC and minimize the connection between the components and the IC. In particular, a capacitor should be connected to V_{OUT} pin with the minimum connection. And make sufficient grounding and reinforce supplying. A large switching current flows through the connection of power supply, an inductor and the connection of V_{OUT} . If the impedance of the connection of power supply is high, the voltage level of power supply of the IC fluctuates with the switching current. This may cause unstable operation of the IC.
- Use capacitors with a capacity of $22\mu\text{F}$ or more for V_{OUT} pin, and with good high frequency characteristics such as tantalum capacitors. We recommend you to use capacitors with an allowable voltage which is at least twice as much as setting output voltage. This is because there may be a case where a spike-shaped high voltage is generated by an inductor when an external transistor is on and off.
- Choose an inductor that has sufficiently small DC resistance and large allowable current and is hard to reach magnetic saturation. And if the value of inductance of an inductor is extremely small, the I_{LX} may exceed the absolute maximum rating at the maximum loading.
Use an inductor with appropriate inductance.
- Use a diode of a Schottky type with high switching speed, and also pay attention to its current capacity.
- Do not use this IC under the condition at V_{IN} voltage less than minimum operating voltage.

☆ The performance of power source circuits using these ICs extremely depends upon the peripheral circuits.

Pay attention in the selection of the peripheral circuits. In particular, design the peripheral circuits in a way that

the values such as voltage, current, and power of each component, PCB patterns and the IC do not exceed their respected rated values.

OPERATION of step-down DC/DC converter and Output Current

The step-down DC/DC converter charges energy in the inductor when Lx transistor is ON, and discharges the energy from the inductor when Lx transistor is OFF and controls with less energy loss, so that a lower output voltage than the input voltage is obtained. The operation will be explained with reference to the following diagrams :

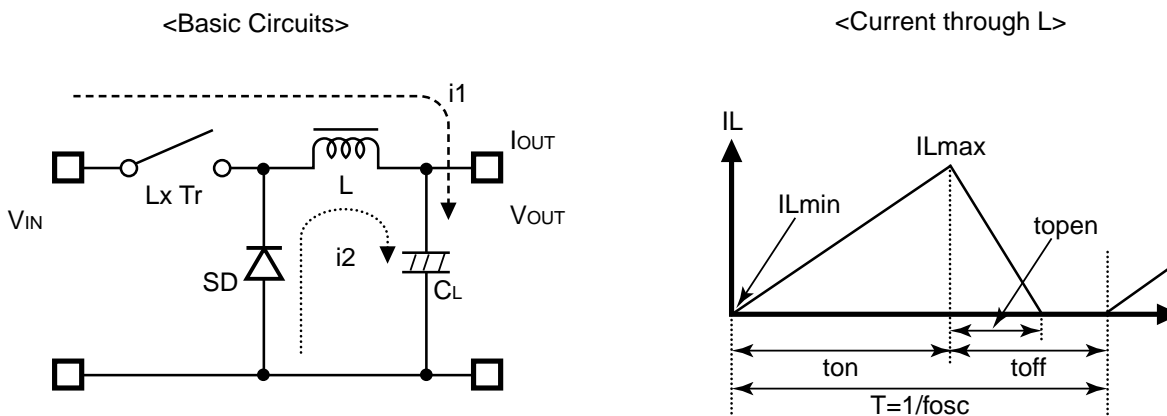

- Step 1 :LxTr turns on and current $I_L (=i_1)$ flows, and energy is charged into CL. At this moment, I_L increases from $I_{Lmin} (=0)$ to reach I_{Lmax} in proportion to the on-time period (t_{on}) of LxTr.
- Step 2 :When LxTr turns off, Schottky diode (SD) turns on in order that L maintains I_L at I_{Lmax} , and current $I_L (=i_2)$ flows.
- Step 3 : I_L decreases gradually and reaches I_{Lmin} after a time period of t_{open} , and SD turns off, provided that in the continuous mode, next cycle starts before I_L becomes to 0 because t_{off} time is not enough. In this case, I_L value increases from this $I_{Lmin} (>0)$.

In the case of PWM control system, the output voltage is maintained by controlling the on-time period (t_{on}), with the oscillator frequency (f_{osc}) being maintained constant.

• Discontinuous Conduction Mode and Continuous Conduction Mode

The maximum value (I_{Lmax}) and the minimum value (I_{Lmin}) of the current which flows through the inductor are the same as those when LxTr is ON and when it is off.

The difference between I_{Lmax} and I_{Lmin} , which is represented by ΔI ;

$$\Delta I = I_{Lmax} - I_{Lmin} = V_{OUT} \times t_{open} / L = (V_{IN} - V_{OUT}) \times t_{on} / L \dots \dots \dots \text{Equation 1}$$

wherein $T = 1/f_{osc} = t_{on} + t_{off}$
 duty (%) = $t_{on} / T \times 100 = t_{on} \times f_{osc} \times 100$
 $t_{open} \leq t_{off}$

In Equation 1, $V_{OUT} \times t_{open}/L$ and $(V_{IN}-V_{OUT}) \times t_{on}/L$ respectively show the change of the current at on state, and the change of the current at off state.

When the output current (I_{OUT}) is relatively small, $t_{open} < t_{off}$ as illustrated in the above diagram. In this case, the energy is charged in the inductor during the time period of t_{on} and is discharged in its entirety during the time period of t_{off} , therefore I_{Lmin} becomes to zero ($I_{Lmin}=0$). When I_{OUT} is gradually increased, eventually, t_{open} becomes to t_{off} ($t_{open}=t_{off}$), and when I_{OUT} is further increased, I_{Lmin} becomes larger than zero ($I_{Lmin}>0$). The former mode is referred to as the discontinuous mode and the latter mode is referred to as continuous mode.

In the continuous mode, when Equation 1 is solved for t_{on} and assumed that the solution is t_{onc} ,

$$t_{onc} = T \times V_{OUT} / V_{IN} \dots\dots\dots \text{Equation 2}$$

When $t_{on} < t_{onc}$, the mode is the discontinuous mode, and when $t_{on} = t_{onc}$, the mode is the continuous mode.

Output Current and Selection of External Components

When $LxTr$ is ON:

(Wherein, Ripple Current P-P value is described as I_{RP} , ON resistance of $LxTr$ is described as R_P the direct current resistance of the inductor is described as R_L .)

$$V_{IN} = V_{OUT} + (R_P + R_L) \times I_{OUT} + L \times I_{RP} / t_{on} \dots\dots\dots \text{Equation 3}$$

When $LxTr$ is OFF:

$$L \times I_{RP} / t_{off} = V_F + V_{OUT} + R_L \times I_{OUT} \dots\dots\dots \text{Equation 4}$$

Put Equation 4 to Equation 3 and solve for ON duty, $t_{on} / (t_{off} + t_{on}) = D_{ON}$,

$$D_{ON} = (V_{OUT} + V_F + R_L \times I_{OUT}) / (V_{IN} + V_F - R_P \times I_{OUT}) \dots\dots\dots \text{Equation 5}$$

Ripple Current is as follows;

$$I_{RP} = (V_{IN} - V_{OUT} - R_P \times I_{OUT} - R_L \times I_{OUT}) \times D_{ON} / f \dots\dots\dots \text{Equation 6}$$

wherein, peak current that flows through L , $LxTr$, and SD is as follows;

$$I_{Lmax} = I_{OUT} + I_{RP} / 2 \dots\dots\dots \text{Equation 7}$$

Consider I_{Lmax} , condition of input and output and select external components.

★ The above explanation is directed to the calculation in an ideal case in continuous mode.

External Components

1. Inductor

Select an inductor that peak current does not exceed I_{Lmax} . If larger current than allowable current flows, magnetic saturation occurs and make transform efficiency worse.

When the load current is same, the smaller value of L is used, the larger the ripple current is.

Provided that the allowable current is large in that case and DC current is small, therefore, for large output current, efficiency is better than using an inductor with a large value of L and vice versa.

2. Diode

Use a diode with low V_F (Schottky type is recommended.) and high switching speed.

Reverse voltage rating should be more than V_{IN} and current rating should be equal or more than I_{Lmax} .

3. Capacitor

As for C_{IN} , use a capacitor with low ESR (Equivalent Series Resistance) and a capacity of at least $10\mu F$ for stable operation.

C_{OUT} can reduce ripple of Output Voltage, therefore 47 to $100\mu F$ tantalum type is recommended.

4. Lx Transistor

Pch Power MOS FET is required for this IC.

Its breakdown voltage between gate and source should be a few volt higher than Input Voltage.

In the case of Input Voltage is low, to turn on MOS FET completely, select a MOS FET with low threshold voltage.

If a large load current is necessary for your application and important, choose a MOS FET with low ON resistance for good efficiency.

If a small load current is mainly necessary for your application, choose a MOS FET with low gate capacity for good efficiency.

Maximum continuous drain current of MOS FET should be larger than peak current, I_{Lmax} .

TYPICAL CHARACTERISTICS

1) Output Voltage vs. Output Current

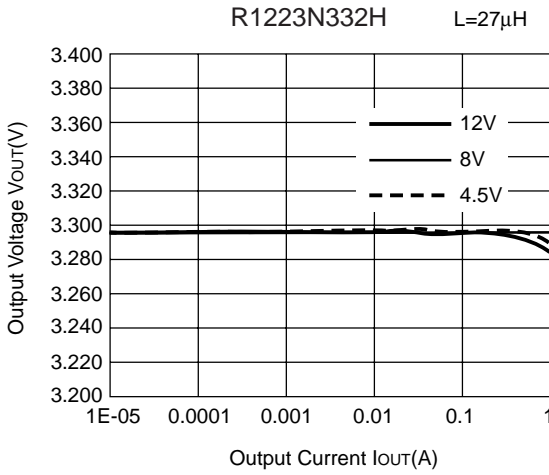

2) Efficiency vs. Output Current

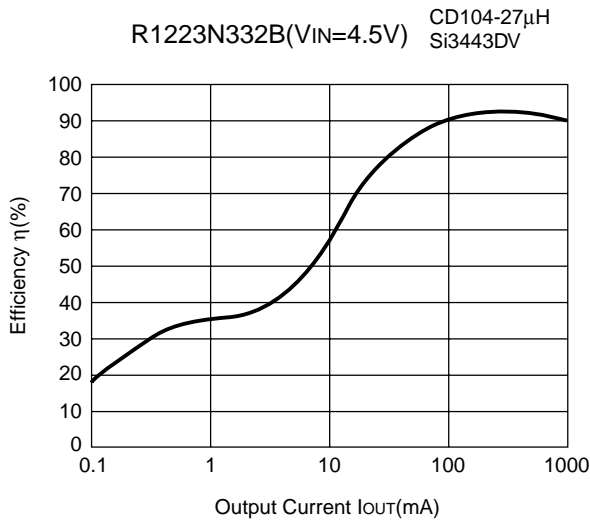
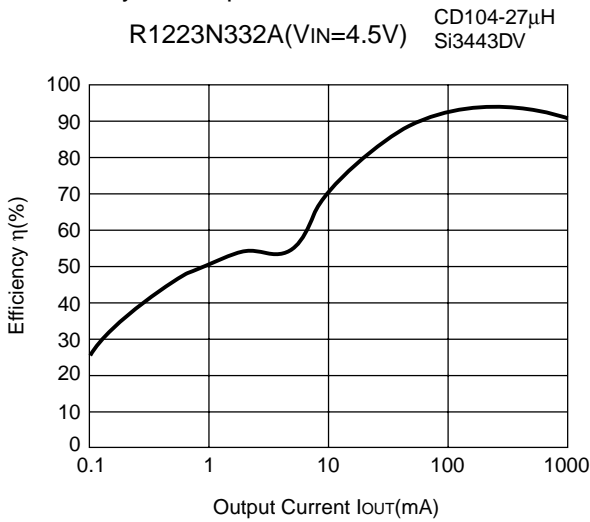

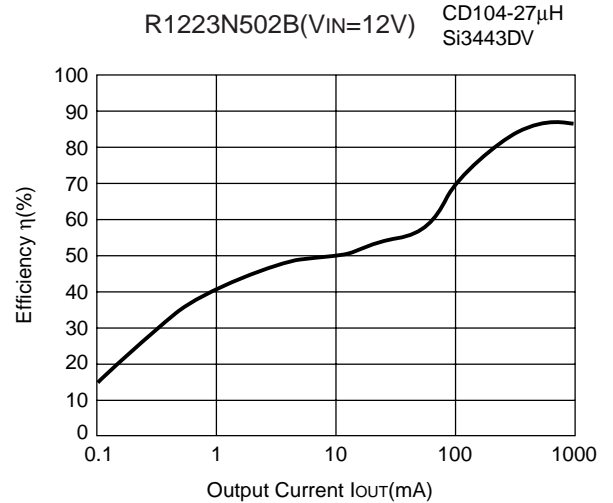
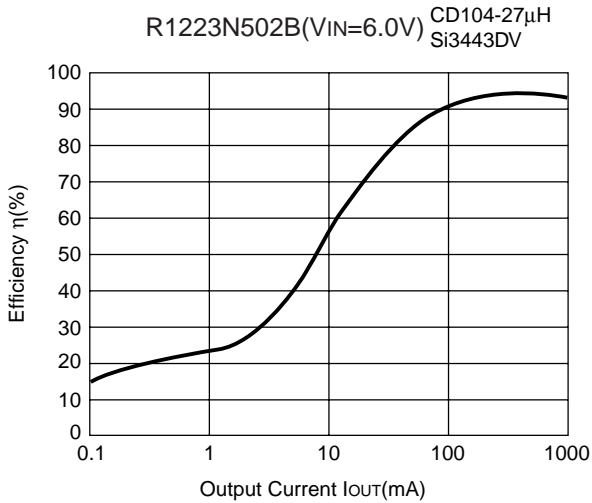
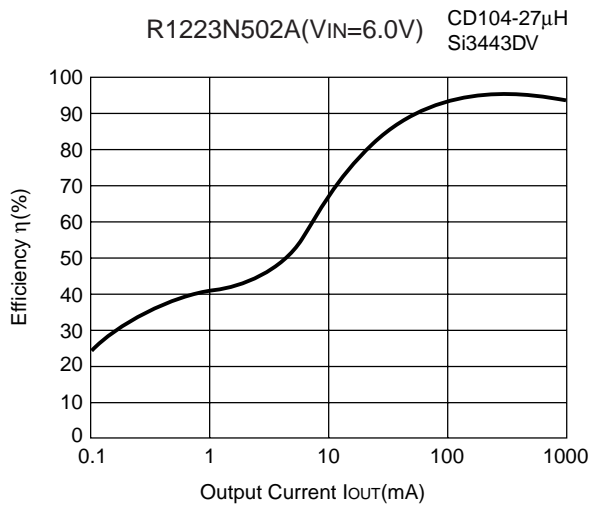

R1223N502C(V_{IN}=6.0V) CD104-27μH
Si3443DV



R1223N502C(V_{IN}=12V) CD104-27μH
Si3443DV



3) Ripple Voltage vs. Output Current

R1223N332A L=27μH

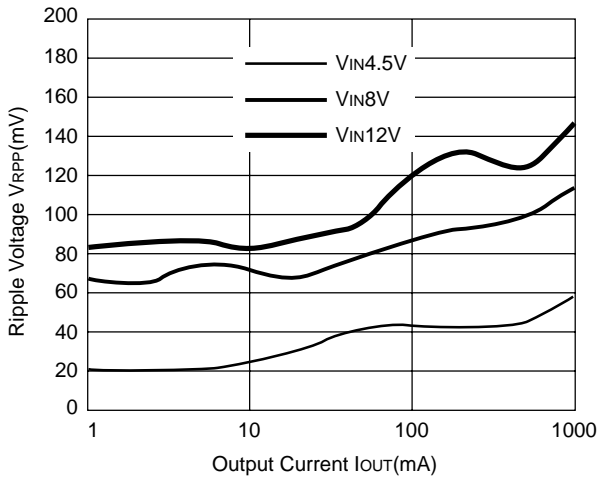

R1223N502A L=27μH

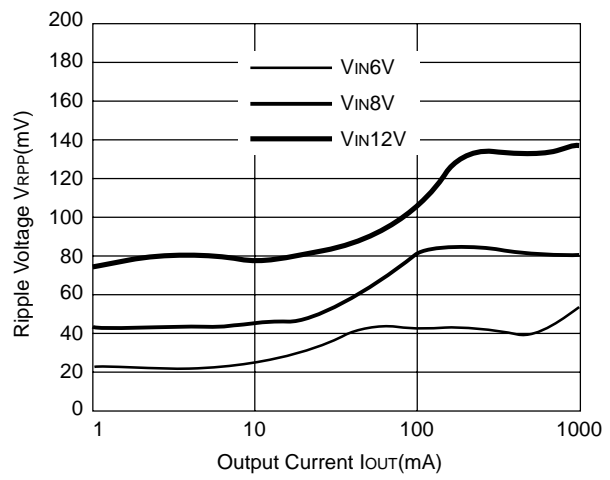

R1223N332B L=27μH

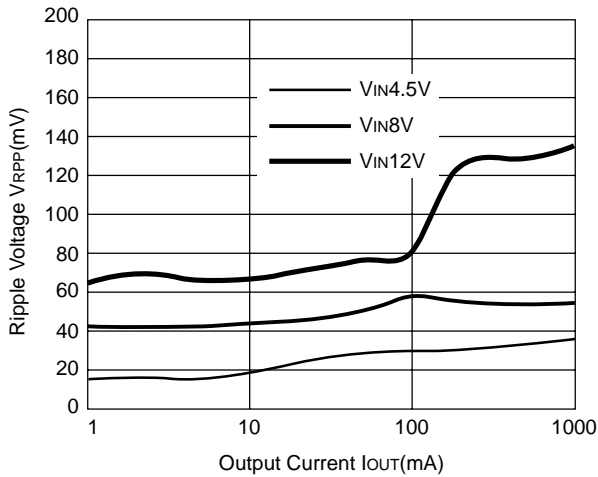

R1223N332H L=27μH

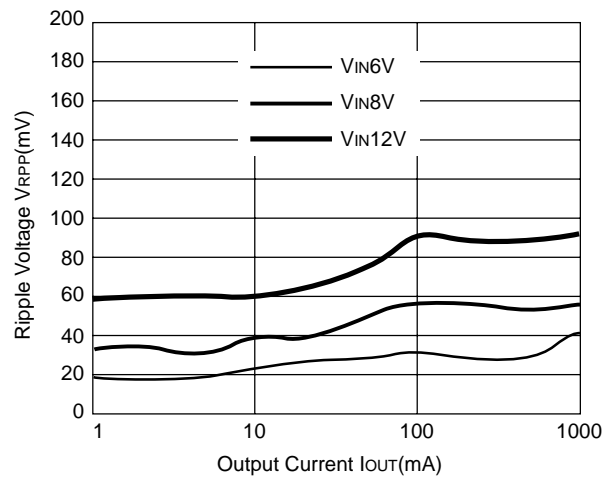

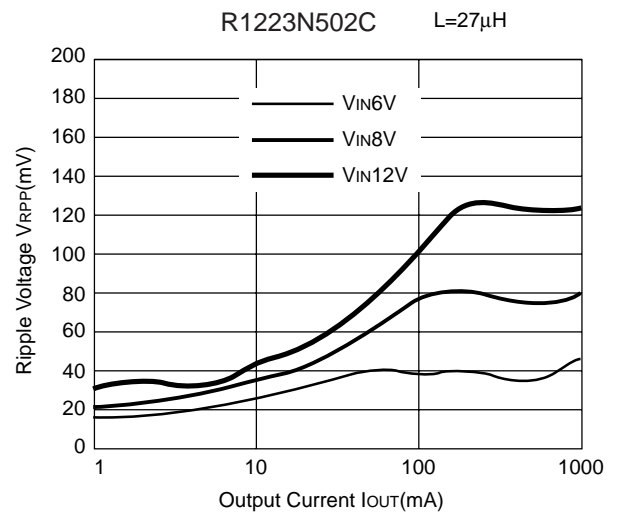

4) Oscillator Frequency vs. Input Voltage

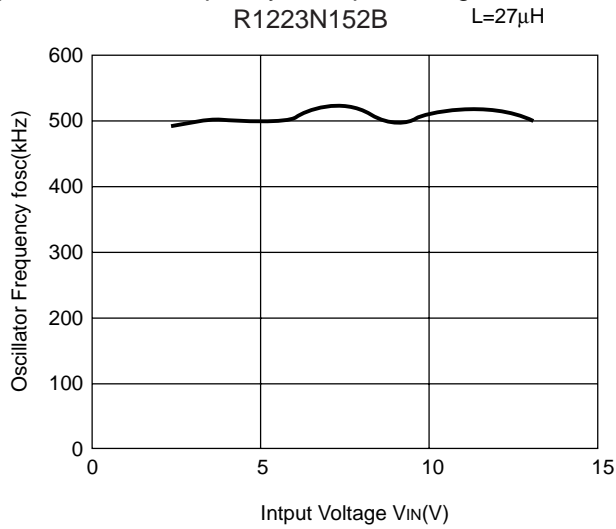

5) Output Voltage vs. Input Voltage

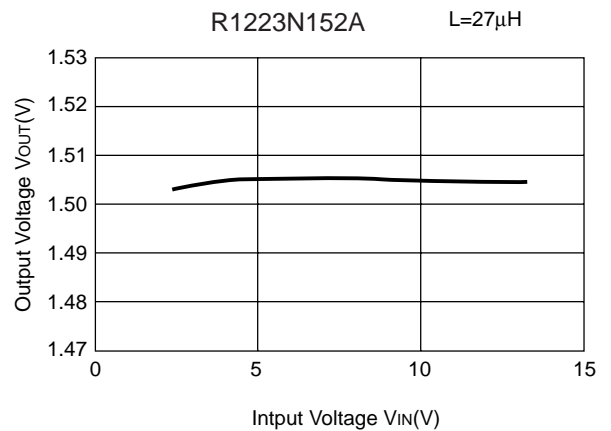
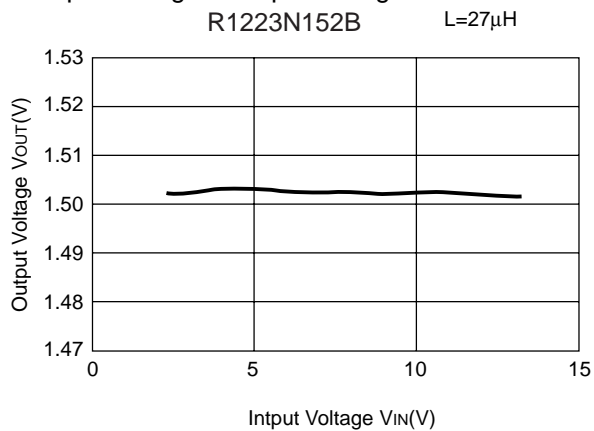

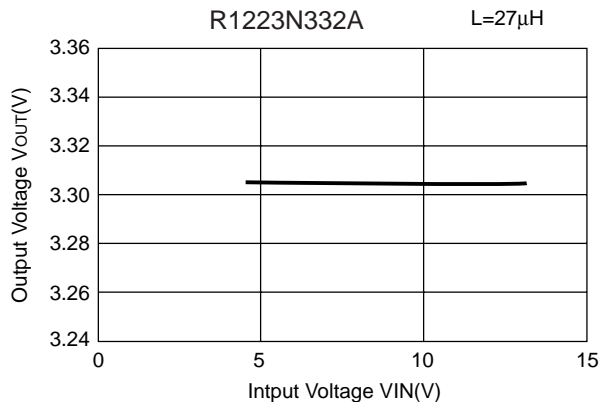
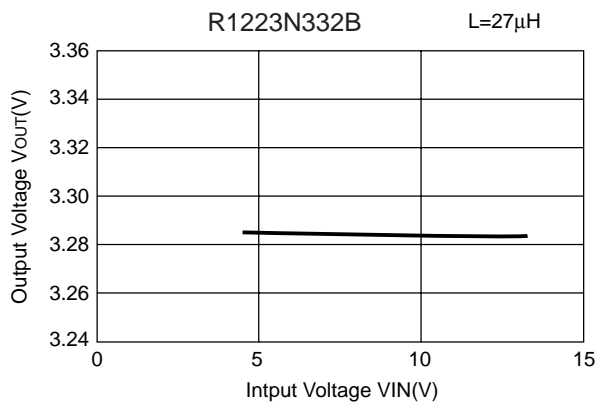

6) Output Voltage vs. Temperature



7) Oscillator Frequency vs. Temperature

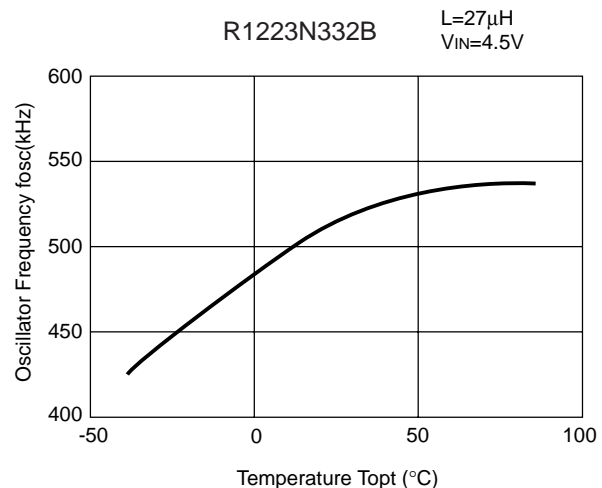

8) Supply Current vs. Temperature

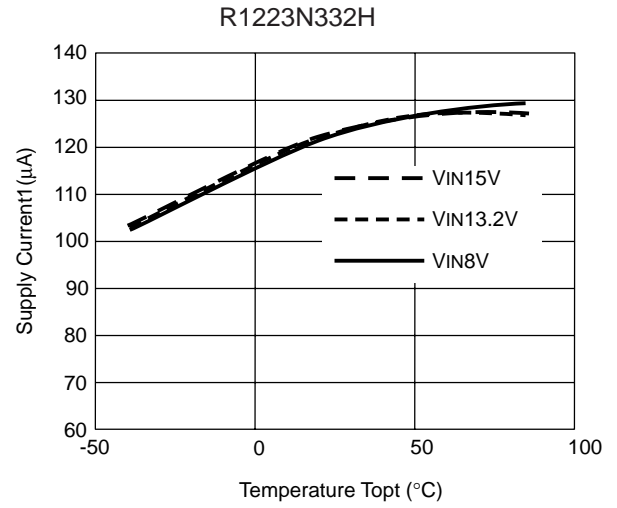
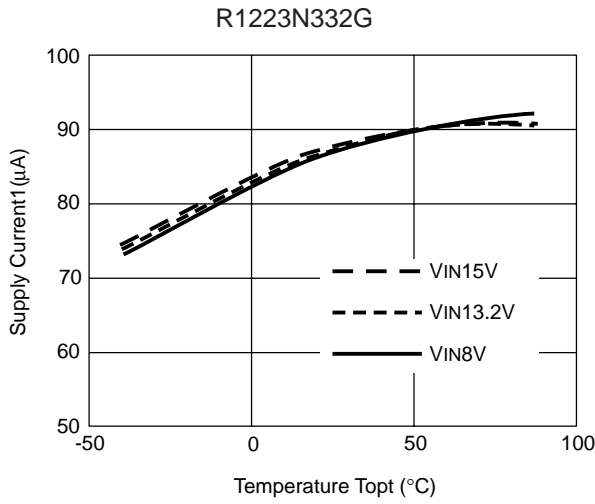

9) Soft-start time vs. Temperature

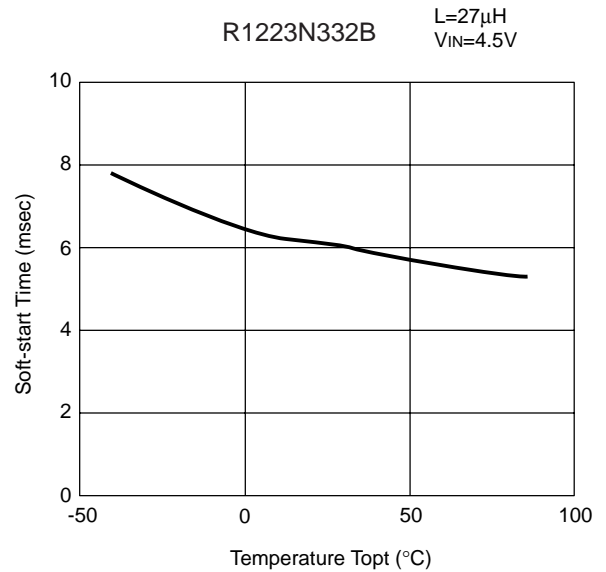

10) Delay Time for Latch-type protection vs. Temperature

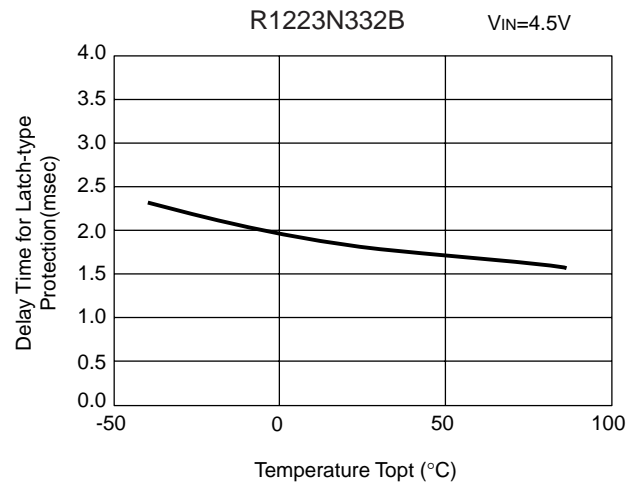
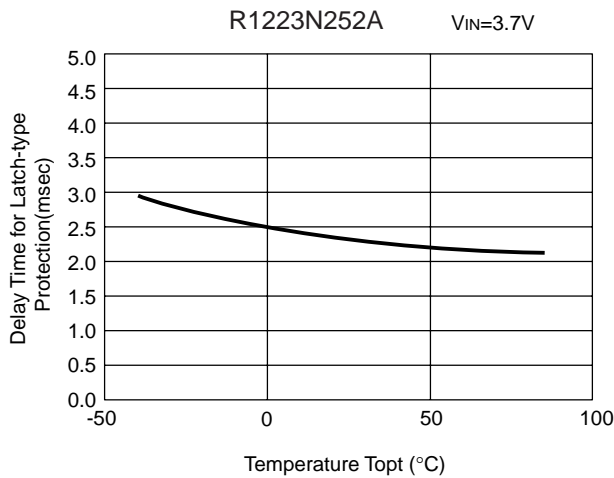

11) Delay Time for Reset-type Protection vs. Temperature

R1223N332G $V_{IN}=4.5V$

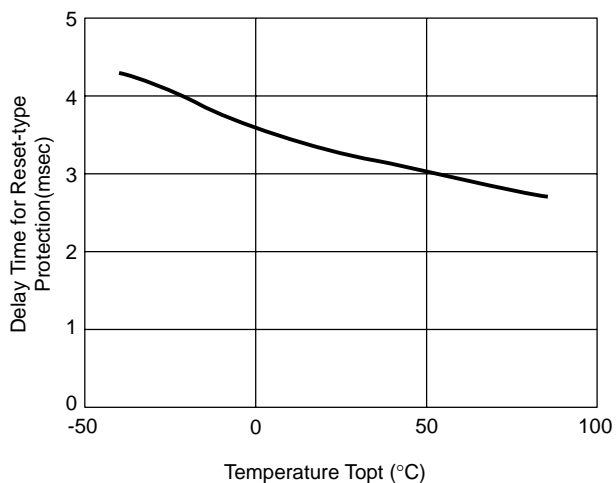

R1223N332H $V_{IN}=4.5V$



12) EXT "H" Output Current vs. Temperature

R1223N332B

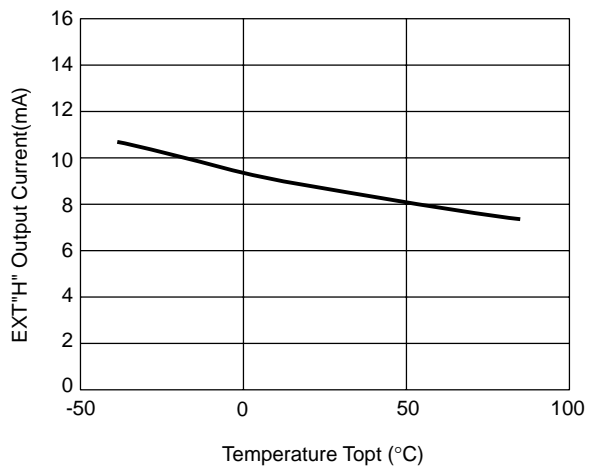

13) EXT "L" Output Current vs. Temperature

R1223N332B



14) Load Transient Response

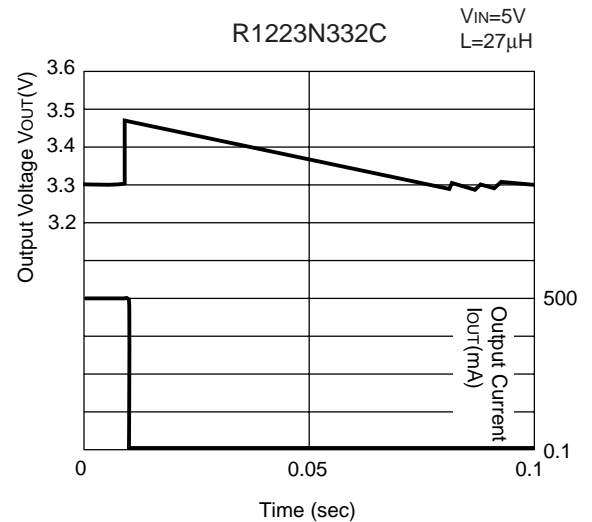
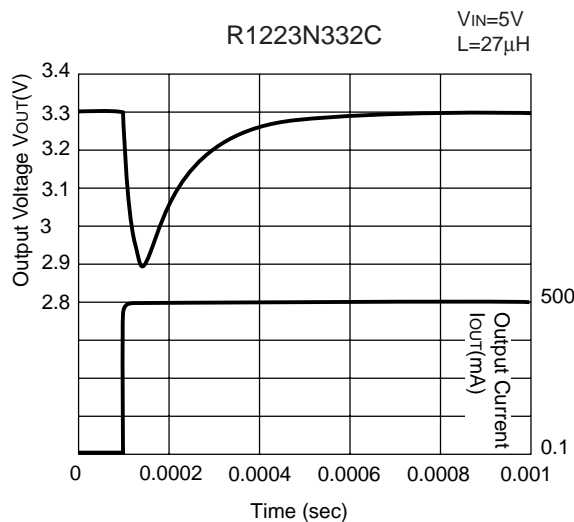
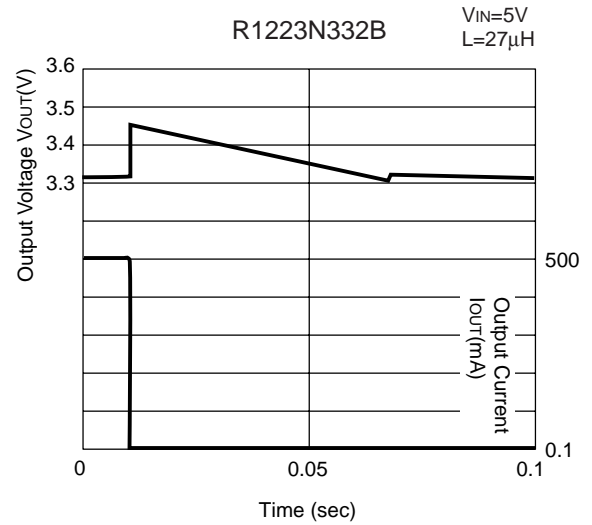
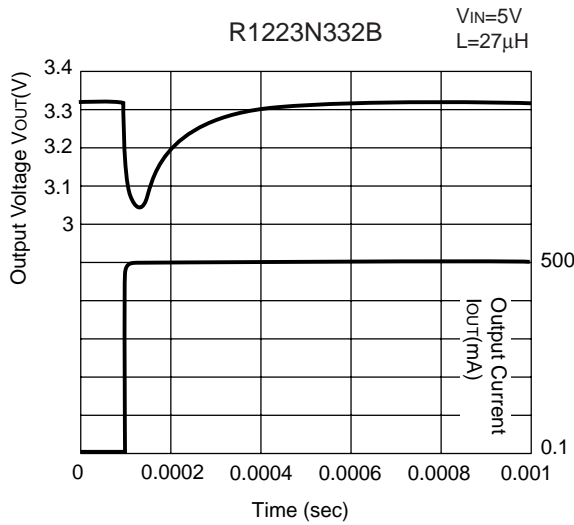
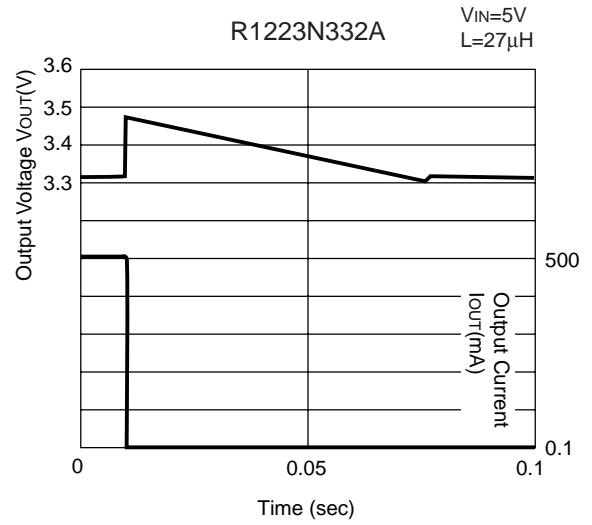
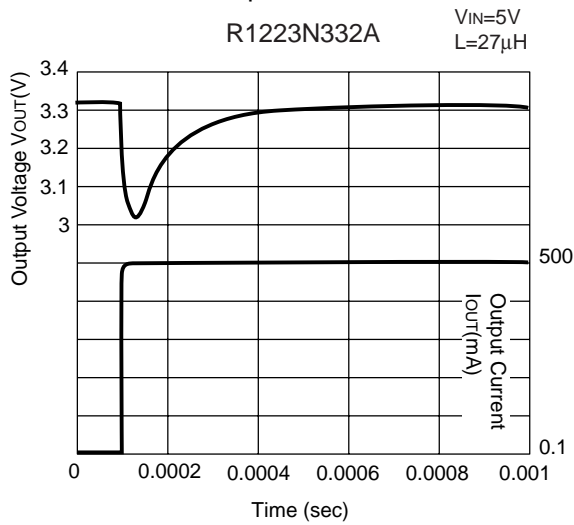



15) Turn-on Waveform

R1223N332A ($V_{IN}=10V, I_{OUT}=0mA$)

$L=27\mu H$

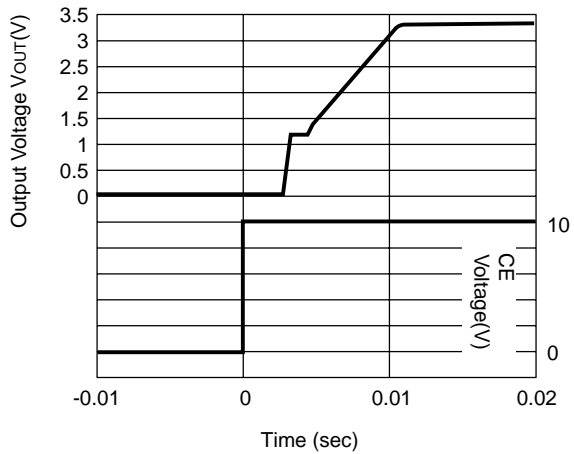

R1223N332A ($V_{IN}=5V, I_{OUT}=0mA$)

$L=27\mu H$

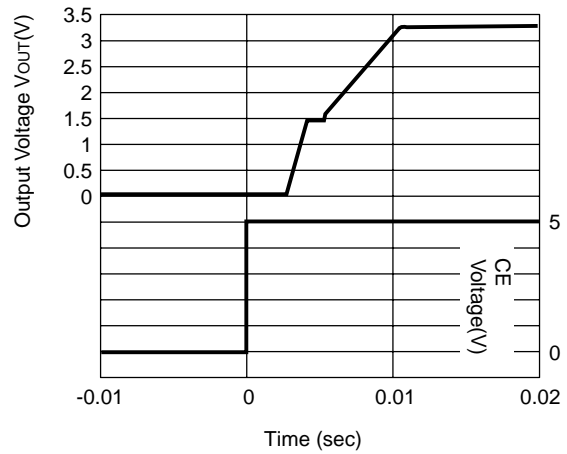

R1223N332B ($V_{IN}=10V, I_{OUT}=0mA$)

$L=27\mu H$



R1223N332B ($V_{IN}=5V, I_{OUT}=0mA$)

$L=27\mu H$







1. The products and the product specifications described in this document are subject to change or discontinuation of production without notice for reasons such as improvement. Therefore, before deciding to use the products, please refer to Ricoh sales representatives for the latest information thereon.
2. The materials in this document may not be copied or otherwise reproduced in whole or in part without prior written consent of Ricoh.
3. Please be sure to take any necessary formalities under relevant laws or regulations before exporting or otherwise taking out of your country the products or the technical information described herein.
4. The technical information described in this document shows typical characteristics of and example application circuits for the products. The release of such information is not to be construed as a warranty of or a grant of license under Ricoh's or any third party's intellectual property rights or any other rights.
5. The products listed in this document are intended and designed for use as general electronic components in standard applications (office equipment, telecommunication equipment, measuring instruments, consumer electronic products, amusement equipment etc.). Those customers intending to use a product in an application requiring extreme quality and reliability, for example, in a highly specific application where the failure or misoperation of the product could result in human injury or death (aircraft, spacevehicle, nuclear reactor control system, traffic control system, automotive and transportation equipment, combustion equipment, safety devices, life support system etc.) should first contact us.
6. We are making our continuous effort to improve the quality and reliability of our products, but semiconductor products are likely to fail with certain probability. In order to prevent any injury to persons or damages to property resulting from such failure, customers should be careful enough to incorporate safety measures in their design, such as redundancy feature, fire containment feature and fail-safe feature. We do not assume any liability or responsibility for any loss or damage arising from misuse or inappropriate use of the products.
7. Anti-radiation design is not implemented in the products described in this document.
8. Please contact Ricoh sales representatives should you have any questions or comments concerning the products or the technical information.



Ricoh is committed to reducing the environmental loading materials in electrical devices with a view to contributing to the protection of human health and the environment.

Ricoh has been providing RoHS compliant products since April 1, 2006 and Halogen-free products since April 1, 2012.

RICOH RICOH ELECTRONIC DEVICES CO., LTD.

<http://www.e-devices.ricoh.co.jp/en/>

Sales & Support Offices

RICOH ELECTRONIC DEVICES CO., LTD.

Higashi-Shinagawa Office (International Sales)
3-32-3, Higashi-Shinagawa, Shinagawa-ku, Tokyo 140-8655, Japan
Phone: +81-3-5479-2857 Fax: +81-3-5479-0502

RICOH EUROPE (NETHERLANDS) B.V.

Semiconductor Support Centre
Prof. W.H. Keesomlaan 1, 1183 DJ Amstelveen, The Netherlands
Phone: +31-20-5474-309

RICOH ELECTRONIC DEVICES KOREA CO., LTD.

3F, Haesung Bldg. 504, Teheran-ro, Gangnam-gu, Seoul, 135-725, Korea
Phone: +82-2-2135-5700 Fax: +82-2-2051-5713

RICOH ELECTRONIC DEVICES SHANGHAI CO., LTD.

Room 403, No.2 Building, No.690 Bilbo Road, Pu Dong New District, Shanghai 201203,
People's Republic of China
Phone: +86-21-5027-3200 Fax: +86-21-5027-3299

RICOH ELECTRONIC DEVICES CO., LTD.

Taipei office
Room 109, 10F-1, No.51, Hengyang Rd., Taipei City, Taiwan (R.O.C.)
Phone: +886-2-2313-1621/1622 Fax: +886-2-2313-1623

Mouser Electronics

Authorized Distributor

Click to View Pricing, Inventory, Delivery & Lifecycle Information:

[Ricoch Electronics:](#)

[R1223N332F-TR-FE](#) [R1223N332E-TR-FE](#)



Компания «ЭлектроПласт» предлагает заключение долгосрочных отношений при поставках импортных электронных компонентов на взаимовыгодных условиях!

Наши преимущества:

- Оперативные поставки широкого спектра электронных компонентов отечественного и импортного производства напрямую от производителей и с крупнейших мировых складов;
- Поставка более 17-ти миллионов наименований электронных компонентов;
- Поставка сложных, дефицитных, либо снятых с производства позиций;
- Оперативные сроки поставки под заказ (от 5 рабочих дней);
- Экспресс доставка в любую точку России;
- Техническая поддержка проекта, помощь в подборе аналогов, поставка прототипов;
- Система менеджмента качества сертифицирована по Международному стандарту ISO 9001;
- Лицензия ФСБ на осуществление работ с использованием сведений, составляющих государственную тайну;
- Поставка специализированных компонентов (Xilinx, Altera, Analog Devices, Intersil, Interpoint, Microsemi, Aeroflex, Peregrine, Syfer, Eurofarad, Texas Instrument, Miteq, Cobham, E2V, MA-COM, Hittite, Mini-Circuits, General Dynamics и др.);

Помимо этого, одним из направлений компании «ЭлектроПласт» является направление «Источники питания». Мы предлагаем Вам помощь Конструкторского отдела:

- Подбор оптимального решения, техническое обоснование при выборе компонента;
- Подбор аналогов;
- Консультации по применению компонента;
- Поставка образцов и прототипов;
- Техническая поддержка проекта;
- Защита от снятия компонента с производства.



Как с нами связаться

Телефон: 8 (812) 309 58 32 (многоканальный)

Факс: 8 (812) 320-02-42

Электронная почта: org@eplast1.ru

Адрес: 198099, г. Санкт-Петербург, ул. Калинина, дом 2, корпус 4, литера А.