

## Low On Resistance/ Low Voltage 1ch 500mA/ 1.0A Alternative LDO

NO. EA-274-150708

### OUTLINE

The RP115x Series are CMOS-based positive voltage regulators featuring 500mA/ 1.0A that provide high ripple rejection, low dropout voltage, high output voltage accuracy, and low supply current. Internally, the RP115x Series consist of a voltage reference unit, an error amplifier, a resistor-net for output voltage setting, a current limit circuit, a thermal shutdown circuit, and a reverse current protection circuit.

The RP115x Series uses CMOS process for achieving low supply current, low On Resistance for low dropout voltage (TYP. 0.195V (DFN1216-8,  $I_{OUT}=1.0A$ ,  $V_{SET}=1.2V$ )) and CE function for long battery life.

Excellent ripple rejection, input transient response, and load transient response make this series ideal for the power sources of mobile communication equipments.

The RP115x Series are available in the DFN1216-8 package for space saving and the SOT-89-5 (Output current: 1.0A fixed) package for higher power applications.

The RP115L Series (DFN1216-8 package) can choose the output current limit between 1.0A or 500mA by alternating the LCON pin between "H" or "L".

The RP115H Series (SOT-89-5 package) can output only 1.0A since it does not include the LCON pin.

### FEATURES

- Supply Current ..... TYP. 110 $\mu$ A
- Supply Current (Standby Mode) ..... TYP. 0.5 $\mu$ A
- Dropout Voltage ..... TYP. 0.195V (DFN1216-8:  $I_{OUT}=1.0A$ ,  $V_{SET}=1.2 V$ )  
TYP. 0.235V (SOT-89-5:  $I_{OUT}=1.0A$ ,  $V_{SET}=1.2 V$ )
- Ripple Rejection ..... TYP. 80dB (f=1kHz,  $V_{SET} \leq 1.8V$ )  
TYP. 75dB (f=1kHz,  $V_{SET} > 1.8V$ )
- Output Voltage Accuracy .....  $\pm 1.0\%$  ( $V_{SET} \geq 1.75V$ )
- Output Voltage Temperature Coefficient ..... TYP.  $\pm 30$ ppm/  $^{\circ}C$  ( $V_{SET} \geq 1.75V$ )
- Line Regulation ..... TYP. 0.02%/V
- Package ..... DFN1216-8, SOT-89-5
- Output Voltage Range ..... 0.7V to 4.3V<sup>\*1</sup> (0.1V increments)
- Built-in Short Current Limit Circuit ..... TYP. 60mA (DFN1216-8: LCON = "L")
- Built-in Peak Current Limit
- Built-in Thermal Shutdown Circuit ..... Thermal Shutdown Temperature: 165 $^{\circ}C$
- Built-in Constant Slope Circuit for Start-up
- Built-in Inrush Current Suppression Circuit .... TYP. 300mA (DFN1216-8: LCON="L")
- Reverse Current Protection
- Recommended Ceramic Capacitors ..... 1.0 $\mu$ F or more

\*1 For the voltages in 0.05V increments, please refer to SELECTION GUIDE.

### APPLICATIONS

- Power source for portable communication equipments.
- Power source for electrical appliances such as cameras, VCRs and camcorders.
- Power source for battery-powered equipments.
- Local power source for home appliances, printers, scanners, office equipment machines.

**BLOCK DIAGRAMS**

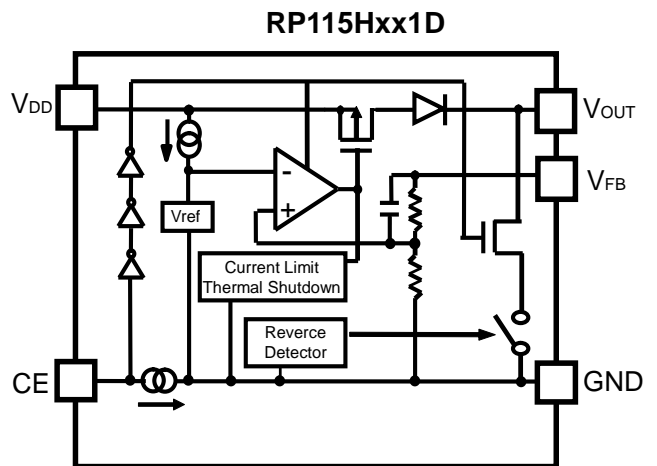
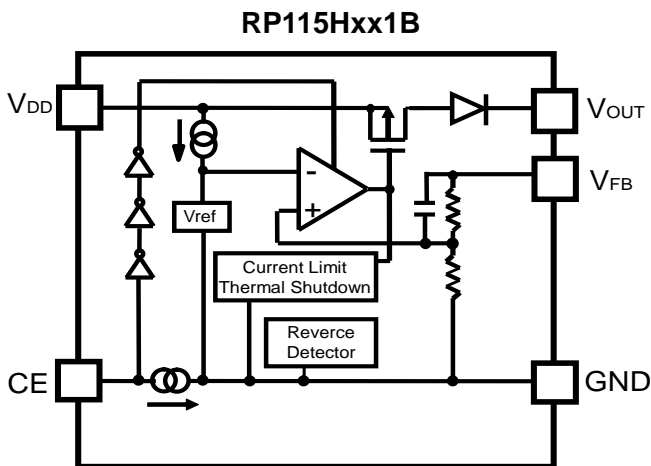

**Note:** The RP115H does not include the LCON pin. The output current limit is fixed at 1A.

## SELECTION GUIDE

The output voltage, the auto-discharge function<sup>\*2</sup>, and the package type for the ICs are user-selectable.

Product Name	Package	Quantity per Reel	Pb Free	Halogen Free
RP115Lxx1*(y)-E2	DFN1216-8	5,000 pcs	Yes	Yes
RP115Hxx1*(y)-T1-FE	SOT-89-5	1,000 pcs	Yes	Yes

xx: Specify the output voltage ( $V_{SET}$ ) within the range of 0.7V (07) to 4.3V (43) in 0.1V steps.

(y): If the output voltage includes the 3rd digit, indicate the digit of 0.01.  
(0.75V, 1.15V, 1.25V, 1.35V, 1.75V, 1.85V, 2.15V, 2.85V, 2.95V)

Ex. If the output voltage is 0.75V, RP115x071\*5  
 1.15V, RP115x111\*5  
 1.25V, RP115x121\*5  
 1.35V, RP115x131\*5  
 1.75V, RP115x171\*5  
 1.85V, RP115x181\*5  
 2.15V, RP115x211\*5  
 2.85V, RP115x281\*5  
 2.95V, RP115x291\*5

\*: Specify the version with auto-discharge function or without auto-discharge function.  
 (B) without auto-discharge function  
 (D) with auto-discharge function

<sup>\*2</sup> Auto-discharge function quickly lowers the output voltage to 0V by releasing the electrical charge in the external capacitor when the chip enable signal is switched from the active mode to the standby mode.

## PIN CONFIGURATIONS



## PIN DESCRIPTION

### RP115L: DFN1216-8<sup>\*3</sup>

Pin No	Symbol	Pin Description
1	$V_{OUT}^{*4}$	Output Pin
2	$V_{OUT}^{*4}$	Output Pin
3	LCON	Output Current Limit Alternate Pin ("H"=1A, "L"=500mA)
4	$V_{FB}^{*4}$	Feedback Pin
5	GND	Ground Pin
6	CE	Chip Enable Pin
7	$V_{DD}^{*5}$	Input Pin
8	$V_{DD}^{*5}$	Input Pin

<sup>\*3</sup> The exposed tab on the bottom of the package enhances thermal performance and is electrically connected to GND (substrate level). It is recommended that the exposed tab be connected to the ground plane on the board or otherwise be left open.

<sup>\*4</sup> The  $V_{OUT}$  pins and the  $V_{FB}$  pin must be wired together when mounting on the board.

<sup>\*5</sup> The  $V_{DD}$  pins must be wired together when mounting on the board.

### RP115H: SOT-89-5

Pin No	Symbol	Pin Description
1	$V_{FB}^{*6}$	Feedback Pin
2	GND	Ground Pin
3	CE	Chip Enable Pin
4	$V_{DD}$	Input Pin
5	$V_{OUT}^{*6}$	Output Pin

<sup>\*6</sup> The  $V_{OUT}$  pin and the  $V_{FB}$  pin must be wired together when mounting on the board.

Notes: Output Current Limit is fixed at 1A.

## ABSOLUTE MAXIMUM RATINGS

Symbol	Item	Rating		Unit
$V_{IN}$	Input Voltage	6.0		V
$V_{CE}$	Input Voltage (CE Pin)	-0.3 to 6.0		V
$V_{LCON}$	Input Voltage (LCON Pin)	-0.3 to 6.0		V
$V_{OUT}$	Output Voltage	-0.3 to 6.0		V
$P_D$	Power Dissipation (Standard Land Pattern) <sup>*7</sup>	DFN1216-8	625	mW
		SOT-89-5	900	
$T_a$	Operating Temperature Range	-40 to +85		°C
$T_{stg}$	Storage Temperature Range	-55 to +125		°C

<sup>\*7</sup> For Power Dissipation and Standard Land Pattern, please refer to *PACKAGE INFORMATION*.

### ABSOLUTE MAXIMUM RATINGS

Electronic and mechanical stress momentarily exceeded absolute maximum ratings may cause the permanent damages and may degrade the lifetime and safety for both device and system using the device in the field. The functional operation at or over these absolute maximum ratings is not assured.

### RECOMMENDED OPERATING CONDITIONS (ELECTRICAL CHARACTERISTICS)

All of electronic equipment should be designed that the mounted semiconductor devices operate within the recommended operating conditions. The semiconductor devices cannot operate normally over the recommended operating conditions, even if when they are used over such conditions by momentary electronic noise or surge. And the semiconductor devices may receive serious damage when they continue to operate over the recommended operating conditions.

**RP115x**

NO. EA-274-150708

**ELECTRICAL CHARACTERISTICS** $V_{IN}=V_{SET}+1.0V$ ,  $I_{OUT}=1mA$ ,  $C_{IN}=C_{OUT}=1.0\mu F$ , unless otherwise noted.The specifications in   are guaranteed by design engineering at  $-40^{\circ}C \leq T_a \leq 85^{\circ}C$ .**RP115x**

(Ta=25°C)

Symbol	Item	Conditions	Min.	Typ.	Max.	Unit	
V <sub>OUT</sub>	Output Voltage	Ta=25°C	V <sub>SET</sub> ≥1.75V	x0.99		x1.01	V
			V <sub>SET</sub> <1.75V	-18		+18	mV
		-40°C≤Ta≤85°C	V <sub>SET</sub> ≥1.75V	x0.985		x1.015	V
			V <sub>SET</sub> <1.75V	Refer to <i>Output Voltage</i>			
I <sub>LIM</sub>	Output Current Limit	V <sub>IN</sub> =V <sub>SET</sub> +0.5V	LCON="L"	500			mA
			LCON="H"*9	1.0			A
ΔV <sub>OUT</sub> /ΔI <sub>OUT</sub>	Load Regulation	V <sub>IN</sub> =V <sub>SET</sub> +0.5V 1mA≤I <sub>OUT</sub> ≤500mA	LCON="L"		1	20	mV
		V <sub>IN</sub> =V <sub>SET</sub> +0.5V 1mA≤I <sub>OUT</sub> ≤1.0A	LCON="H"*9			40	
V <sub>DIF</sub>	Dropout Voltage	Refer to <i>Dropout Voltage</i>					
I <sub>SS</sub>	Supply Current	I <sub>OUT</sub> =0mA		110	160	μA	
I <sub>standby</sub>	Standby Current	V <sub>CE</sub> =0V		0.5	3.0	μA	
ΔV <sub>OUT</sub> /ΔV <sub>IN</sub>	Line Regulation	V <sub>SET</sub> +0.5V≤V <sub>IN</sub> ≤5.25V (V <sub>IN</sub> ≥1.4V)		0.02	0.10	%/V	
RR	Ripple Rejection	f=1kHz, Ripple 0.2Vp-p, V <sub>IN</sub> =V <sub>SET</sub> +1.0V, I <sub>OUT</sub> =30mA	V <sub>SET</sub> >1.8V		75		dB
			V <sub>SET</sub> ≤1.8V		80		dB
V <sub>IN</sub>	Input Voltage*10		1.4		5.25	V	
ΔV <sub>OUT</sub> /ΔTa	Output Voltage Temperature Coefficient	-40°C≤Ta≤85°C	V <sub>SET</sub> ≥1.75V		±30		ppm /°C
			V <sub>SET</sub> <1.75V		±100		
I <sub>SC</sub>	Short Current Limit	V <sub>OUT</sub> =0V*11	LCON="L"		60		mA
			LCON="H"*9		110		
I <sub>CE</sub>	CE Pull-down Current		0.05	0.3	0.6	μA	
V <sub>CEH</sub>	CE Input Voltage "H"		1.0			V	
V <sub>CEL</sub>	CE Input Voltage "L"				0.4	V	
I <sub>LCON</sub>	LCON Pull-down Current (RP115L only)		0.05	0.3	0.6	μA	
V <sub>LCONH</sub>	LCON Input Voltage "H" (RP115L only)		1.0			V	
V <sub>LCONL</sub>	LCON Input Voltage "L" (RP115L only)				0.4	V	
T <sub>TSD</sub>	Thermal Shutdown Temperature	Junction Temperature		165		°C	
T <sub>TSR</sub>	Thermal Shutdown Released Temperature	Junction Temperature		110		°C	

Symbol	Item	Conditions		Min.	Typ.	Max.	Unit
I <sub>REV</sub>	Reverse Current	V <sub>OUT</sub> =V <sub>SET</sub> +1.0V, 0≤V <sub>IN</sub> ≤V <sub>OUT</sub>	V <sub>SET</sub> ≥1.75V		7.5		μA
			V <sub>SET</sub> <1.75V		10		
V <sub>REV_DET</sub> <sup>*12</sup>	Detector Offset Voltage in Reverse Current Protection Mode <sup>*13</sup>	V <sub>OUT</sub> ≥0.7V, 0≤V <sub>IN</sub> ≤5.25V			20		mV
V <sub>REV_REL</sub> <sup>*12</sup>	Release Offset Voltage in Reverse Current Protection Mode <sup>*14</sup>	V <sub>OUT</sub> ≥0.7V, 0≤V <sub>IN</sub> ≤5.25V			30	50	mV
en	Output Noise	BW=10Hz to 100kHz	V <sub>SET</sub> ≥1.75V		17 x V <sub>SET</sub>		μVrms
			V <sub>SET</sub> <1.75V		35 x V <sub>SET</sub>		
R <sub>LOW</sub>	Auto-discharge Nch Tr. ON Resistance (RP115xDxx1D only)	V <sub>IN</sub> =4.0V, V <sub>CE</sub> =0V			60		Ω
I <sub>RUSH</sub>	Inrush Current Limit	CC Mode <sup>*15</sup>	LCON="L"		300		mA
			LCON="H" <sup>*9</sup>		500		

All test items listed under *Electrical Characteristics* are done under the pulse load condition (T<sub>j</sub>≈T<sub>a</sub>=25°C) except Output Noise, Ripple Rejection, and Output Voltage Temperature Coefficient.

<sup>\*8</sup> V<sub>SET</sub>=Set Output Voltage

<sup>\*9</sup> RP115H: Same Electrical Characteristics as LCON="H".

<sup>\*10</sup> The maximum input voltage listed under *Electrical Characteristics* is 5.25V. If for any reason the input voltage exceeds 5.25V, it has to be no more than 5.5V with 500 cumulative operating hours.

<sup>\*11</sup> Short Current is the value when V<sub>OUT</sub> and GND are short-circuited after the device starts up. Inrush Current flows when the device starts up while V<sub>OUT</sub> and GND are short-circuited.

<sup>\*12</sup> Guaranteed operating range of reverse current protection circuit is V<sub>OUT</sub>≥0.7V. When V<sub>IN</sub>=V<sub>OUT</sub>=0V, reverse current protection mode is constantly active.

<sup>\*13</sup> V<sub>REV\_DET</sub>=V<sub>IN</sub>-V<sub>OUT</sub>

<sup>\*14</sup> V<sub>REV\_REL</sub>=V<sub>IN</sub>-V<sub>OUT</sub>

<sup>\*15</sup> For CC (Constant Current) Mode, please refer to *Start-up Characteristics*.

## Output Voltage

Set Output Voltage V <sub>SET</sub> (V)	Output Voltage V <sub>OUT</sub> (mV)	
	TYP.	MAX.
0.7	-33	+28
0.8	-35	+29
0.9	-37	+30
1.0	-39	+31
1.1	-41	+33
1.2	-43	+34
1.3	-45	+35
1.4	-47	+36
1.5	-49	+38
1.6	-51	+39
1.7	-53	+40

**RP115x**

NO. EA-274-150708

**Dropout Voltage****RP115L: DFN1216-8**

(Ta=25°C)

Set Output Voltage V <sub>SET</sub> (V)	Dropout Voltage V <sub>DIF</sub> (V)			
	I <sub>OUT</sub> =500mA		I <sub>OUT</sub> =1000mA	
	TYP.	MAX.	TYP.	MAX.
0.7 ≤ V <sub>SET</sub> < 1.1	*16	*16	*16	*16
1.1 ≤ V <sub>SET</sub> < 1.2	*16	*16	*16	0.300
1.2 ≤ V <sub>SET</sub> < 1.3	*16	*16	0.195	0.275
1.3 ≤ V <sub>SET</sub> < 1.5	0.095	0.135	0.185	0.260
1.5 ≤ V <sub>SET</sub> < 1.75V	0.085	0.120	0.165	0.235
1.75V ≤ V <sub>SET</sub> < 2.6	0.075	0.110	0.150	0.215
2.6 ≤ V <sub>SET</sub> < 3.3	0.065	0.090	0.130	0.180
3.3 ≤ V <sub>SET</sub> ≤ 4.3	0.060	0.085	0.125	0.170

If the dropout voltage falls below the release offset value of reverse current protection mode (V<sub>REV\_REL</sub>), the reverse current protection circuit may repeat the detection and release operations. Please refer to *Reverse Current Protection Circuit*.

\*16 Input voltage should be equal or more than the minimum operating voltage (1.4V).

**RP115H: SOT-89-5**

(Ta=25°C)

Set Output Voltage V <sub>SET</sub> (V)	Dropout Voltage V <sub>DIF</sub> (V)	
	I <sub>OUT</sub> =1000mA	
	TYP.	MAX.
0.7 ≤ V <sub>SET</sub> < 1.1	*16	*16
1.1 ≤ V <sub>SET</sub> < 1.2	*16	0.350
1.2 ≤ V <sub>SET</sub> < 1.3	0.235	0.330
1.3 ≤ V <sub>SET</sub> < 1.5	0.225	0.320
1.5 ≤ V <sub>SET</sub> < 1.75V	0.205	0.295
1.75V ≤ V <sub>SET</sub> < 2.6	0.190	0.270
2.6 ≤ V <sub>SET</sub> < 3.3	0.170	0.240
3.3 ≤ V <sub>SET</sub> ≤ 4.3	0.165	0.225

If the dropout voltage falls below the release offset value of reverse current protection mode (V<sub>REV\_REL</sub>), the reverse current protection circuit may repeat the detection and release operations. Please refer to *Reverse Current Protection Circuit*.

\*16 Input voltage should be equal or more than the minimum operating voltage (1.4V).



## TYPICAL APPLICATION



### External Parts Example

**C<sub>IN</sub>:** Ceramic Capacitor, 1.0 $\mu$ F, muRata GRM155R61A105KE15

**C<sub>OUT</sub>:** Ceramic Capacitor, 1.0 $\mu$ F, muRata GRM155R61A105KE15  
 Ceramic Capacitor, 2.2 $\mu$ F, muRata GRM155R61A225KE95

### Notes:

<sup>\*17</sup> The LCON pin is only included in RP115L (DFN1216-8).

<sup>\*18</sup> The V<sub>OUT</sub> pin and the V<sub>FB</sub> pin should be wired together when mounting on the board.

## TECHNICAL NOTES

### Phase Compensation

In LDO (Low Drop Out) regulators, phase compensation is provided to secure stable operation even when the load current is varied. For this purpose, use a capacitor C<sub>OUT</sub> with 1.0 $\mu$ F or more and proper ESR (Equivalent Series Resistance).

Depending on the capacitor size, manufacturer, and part number, the bias characteristics and temperature characteristics are different. Evaluate the circuit taking actual characteristics into account. Especially for the 1.75-V-output product, it is recommended to use 2.2 $\mu$ F or higher output capacitor when the product is used under the low-temperature environment such as  $-20^{\circ}\text{C}$  or lower.

If you use a tantalum type capacitor and the ESR value of the capacitor is large, the output might be unstable. Evaluate your circuit including consideration of frequency characteristics.

### PCB Layout

Ensure the V<sub>DD</sub> and GND lines are sufficiently robust. If their impedance is too high, noise pickup or unstable operation may result. Connect a capacitor C<sub>IN</sub> with 1.0 $\mu$ F or more between V<sub>DD</sub> and GND pins, and as close as possible to the pins.

Likewise, connect C<sub>OUT</sub> capacitor with suitable values between the V<sub>OUT</sub> and GND pins, and as close as possible to the pins.

## REVERSE CURRENT PROTECTION CIRCUIT

The RP115x Series include a Reverse Current Protection Circuit, which stops the reverse current from  $V_{OUT}$  pin to  $V_{DD}$  pin or to GND pin when  $V_{OUT}$  becomes higher than  $V_{IN}$ .

Usually, the LDO using Pch output transistor contains a parasitic diode between  $V_{DD}$  pin and  $V_{OUT}$  pin.

Therefore, if  $V_{OUT}$  is higher than  $V_{IN}$ , the parasitic diode becomes forward direction. As a result, the current flows from  $V_{OUT}$  pin to  $V_{DD}$  pin.

The ICs of this series switches the mode to the reverse current protection mode before  $V_{IN}$  becomes lower than  $V_{OUT}$  by connecting the parasitic diode of Pch output transistor to the backward direction, and connecting the gate to  $V_{OUT}$  pin. As a result, the Pch output transistor is turned off. However, from  $V_{OUT}$  pin to GND pin, via the internal divider resistors, very small current  $I_{REV}$  flows.

Switching to either the normal mode or to the reverse current protection mode is determined by the magnitude of  $V_{IN}$  voltage and  $V_{OUT}$  voltage. For the stable operation, offset and hysteresis are set as the threshold. The detector threshold is set to  $V_{REV\_DET}$  and the released voltage is set to  $V_{REV\_REL}$ . Therefore, the minimum dropout voltage under the small load current condition is restricted by the value of  $V_{REV\_REL}$ .

Following figures show the diagrams of each mode, and the load characteristics of each mode. When giving the  $V_{OUT}$  pin a constant-voltage and decreasing the  $V_{IN}$  voltage, the dropout voltage will become lower than  $V_{REV\_DET}$ . As a result, the reverse current protection starts to function to stop the load current.

By increasing the dropout voltage higher than  $V_{REV\_REL}$ , the protection mode will be released to let the load current to flow. If the dropout voltage to be used is lower than  $V_{REV\_REL}$ , the detection and the release may be repeated.

The operating voltage guaranteed level of the reverse current protection circuit is for  $V_{OUT} \geq 0.7V$ . If  $V_{IN}=0V$ , the reverse current protection mode becomes always active.



Figure 1. Normal Operation Mode



Figure 2. Reverse Current Protection Mode

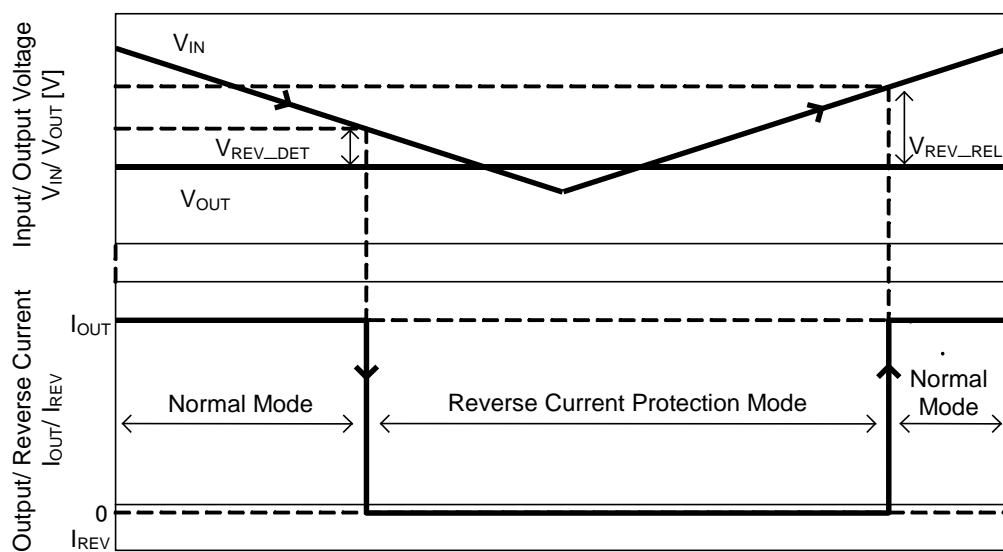

Figure 3. Detection/ Release Timing of Reverse Current Protection Function

**START-UP CHARACTERISTICS**

Constant slope circuit is included in the RP115x Series to prevent the overshoot of the output voltage. The start-up time ( $t_{ON}$ ) is 100 $\mu$ s (Typ.).

If inrush current increases due to the large capacitance of  $C_{OUT}$ , the operation mode will be shifted from Constant Slope (CS) mode to Constant Current (CC) mode. The CC mode maintains a constant level of inrush current. In the CC mode,  $t_{ON}$  varies according to the size of  $C_{OUT}$  and the amount of load current.

**Start-up Time and Inrush Current Estimations**

Start-up time and inrush current in the CS mode and the CC mode can be estimated as follows.

• CS Mode

Start-up Time:  $t_{ON} = 100\mu s$  (TYP.)

Inrush Current:  $I_{RUSH} = C_{OUT} \cdot V_{SET} / t_{ON} + I_{OUT}^{*19}$

Note: If the result of the above calculation is more than the following values, the operation mode will be shifted from the CS mode to the CC mode.

LCON="L"..... 300mA (TYP.)

LCON="H"..... 500mA (TYP.)

• CC Mode

Start-up Time:  $t_{ON} = C_{OUT} \cdot V_{SET} / I_{CO}^{*20}$

Inrush Current:  $I_{RUSH}$  LCON="L"..... 300mA (TYP.)

LCON="H"..... 500mA (TYP.)

\*19  $I_{OUT}$ : When  $R_{LOAD}$  is connected to load,  $I_{OUT}$  can be calculated by  $R_{LOAD} = V_{SET} / I_{OUT}$ .

\*20  $I_{CO}$ :  $I_{CO}$  is a charge current of  $C_{OUT}$  and can be calculated roughly by  $I_{RUSH} \approx I_{CO} + I_{OUT}$ .

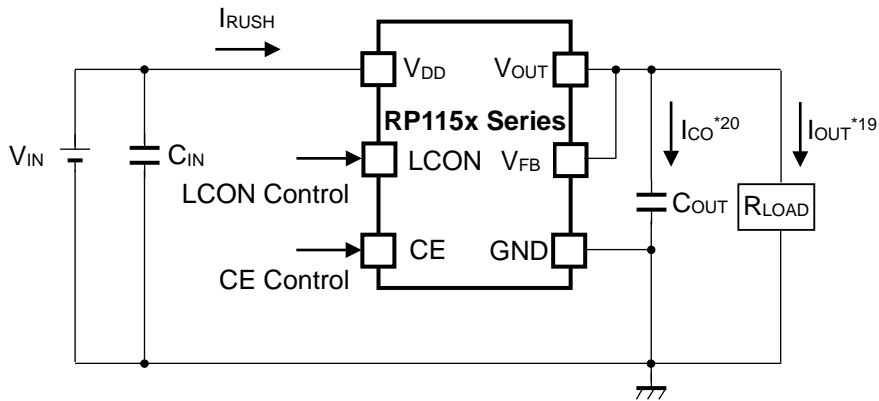

**Circuit Example**

Note: The LCON pin is only included in RP115L (DFN1216-8).

RP115H: Same Electrical Characteristics as LCON="H".



**Precautions Before Use**

During the start-up, the inrush current limit circuit is in operation; therefore, the load current ( $I_{OUT}$ ) should be drawn after the output voltage ( $V_{OUT}$ ) reached the preset value (Best timing:  $t_{ON} + 60\mu s$  or more). If the load current is drawn during the start-up, it should be within the following values.

- LCON="L" .....  $I_{OUT} \leq 150mA$
- LCON="H" .....  $I_{OUT} \leq 350mA$

In the CC mode,  $I_{RUSH}$  is limited until  $V_{OUT}$  reaches the preset value.  $I_{RUSH} \approx I_{CO} + I_{OUT}$  is true; therefore, if large  $I_{OUT}$  is drawn during the start-up, the charge current ( $I_{CO}$ ) of  $C_{OUT}$  decreases and  $t_{ON}$  becomes longer. Please refer to *Start-up Time and Inrush Current Estimations*.

In order to control the start-up operation by using the CS mode or CC mode, input "H" into the CE pin while  $V_{IN} \geq 1.4V$ . If "H" is input into the CE pin while  $V_{IN}$  is less than the minimum operating voltage, the operation may not be controlled by the CS mode or CC mode.

When starting up the device while the short circuit is occurring between the  $V_{OUT}$  pin and GND, the short current protection circuit does not control the current but the current limit circuit does. When there's excessive heat generation in the device, thermal shutdown circuit shuts down the circuitry before the device overheats dangerously.

## LCON PIN OPERATION

By alternating the LCON pin between “H” or “L”, the RP115L can choose the output current limit either 1.0A or 500mA. Please note that during start-up ( $t_{ON} + 60\mu s$  (TYP.)), do not change the logic of the LCON pin.

LCON=“L” ..... 500mA

LCON=“H” ..... 1.0A

### Application Example

Even when using the RP115L with LCON=“H”,  $I_{RUSH}$  in the CC mode can be reduced from 500mA (TYP.) to 300mA (TYP.) by starting up the IC with LCON=“L”. Please refer to *START-UP CHARACTERISTICS*.

## PACKAGE INFORMATION

### Power Dissipation (DFN1216-8)

Power Dissipation ( $P_D$ ) depends on conditions of mounting on board. This specification is based on the Measurement Conditions below.

#### Measurement Conditions

	Standard Land Pattern
Environment	Mounting on Board (Wind Velocity=0m/s)
Board Material	Glass cloth epoxy plastic (Double sided)
Board Dimensions	40mm*40mm*1.6mm
Copper Ratio	Top side: Approx. 50%, Back side: Approx. 50%
Through-holes	$\phi$ 0.5mm * 28pcs

#### Measurement Result

( $T_a=25^\circ\text{C}$ )

	Standard Land Pattern
Power Dissipation	625mW ( $T_{jmax}=125^\circ\text{C}$ ) 781mW ( $T_{jmax}=150^\circ\text{C}$ )
Thermal Resistance	$\theta_{ja} = (125-25^\circ\text{C})/0.625\text{W} = 160^\circ\text{C/W}$ $\theta_{jc} = 26^\circ\text{C/W}$



**Power Dissipation**



**Measurement Board Pattern**

 IC Mount Area (Unit: mm)

Note: The above graph shows the power dissipation of the package based on  $T_{jmax}=125^\circ\text{C}$  and  $T_{jmax}=150^\circ\text{C}$ . Operating the IC within the shaded area in the graph might have an influence on its lifetime. Operating time must be within the time limit described in the table below.

Operating Time	Estimated Years (Operating 4 hrs/ day)
13,000 hours	9 Years

**RP115x**

NO. EA-274-150708

**Package Dimensions (DFN1216-8)**



**DFN1216-8 Package Dimensions**

**Mark Specification (DFN1216-8)**

- ①②③④: Product Code ... **Please refer to Mark Specification Table (DFN1216-8).**
- ⑤⑥: Lot Number ... Alphanumeric Serial Number

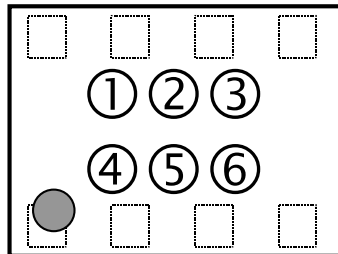

**DFN1216-8 Mark Specification**



Mark Specification Table (DFN1216-8)

RP115Lxx1B

Product Name	①②③④	V <sub>SET</sub>
RP115L071B	DU07	0.7V
RP115L081B	DU08	0.8V
RP115L091B	DU09	0.9V
RP115L101B	DU10	1.0V
RP115L111B	DU11	1.1V
RP115L121B	DU12	1.2V
RP115L131B	DU13	1.3V
RP115L141B	DU14	1.4V
RP115L151B	DU15	1.5V
RP115L161B	DU16	1.6V
RP115L171B	DU17	1.7V
RP115L181B	DU18	1.8V
RP115L191B	DU19	1.9V
RP115L201B	DU20	2.0V
RP115L211B	DU21	2.1V
RP115L221B	DU22	2.2V
RP115L231B	DU23	2.3V
RP115L241B	DU24	2.4V
RP115L251B	DU25	2.5V
RP115L261B	DU26	2.6V
RP115L271B	DU27	2.7V
RP115L281B	DU28	2.8V
RP115L291B	DU29	2.9V
RP115L301B	DU30	3.0V
RP115L311B	DU31	3.1V
RP115L321B	DU32	3.2V
RP115L331B	DU33	3.3V
RP115L341B	DU34	3.4V
RP115L351B	DU35	3.5V
RP115L361B	DU36	3.6V
RP115L371B	DU37	3.7V
RP115L381B	DU38	3.8V
RP115L391B	DU39	3.9V
RP115L401B	DU40	4.0V
RP115L411B	DU41	4.1V
RP115L421B	DU42	4.2V
RP115L431B	DU43	4.3V
RP115L071B5	DU00	0.75V
RP115L121B5	DU01	1.25V
RP115L181B5	DU02	1.85V
RP115L281B5	DU03	2.85V
RP115L131B5	DU04	1.35V
RP115L111B5	DU05	1.15V
RP115L211B5	DU06	2.15V
RP115L291B5	DU60	2.95V
RP115L171B5	DU61	1.75V

RP115Lxx1D

Product Name	①②③④	V <sub>SET</sub>
RP115L071D	DV07	0.7V
RP115L081D	DV08	0.8V
RP115L091D	DV09	0.9V
RP115L101D	DV10	1.0V
RP115L111D	DV11	1.1V
RP115L121D	DV12	1.2V
RP115L131D	DV13	1.3V
RP115L141D	DV14	1.4V
RP115L151D	DV15	1.5V
RP115L161D	DV16	1.6V
RP115L171D	DV17	1.7V
RP115L181D	DV18	1.8V
RP115L191D	DV19	1.9V
RP115L201D	DV20	2.0V
RP115L211D	DV21	2.1V
RP115L221D	DV22	2.2V
RP115L231D	DV23	2.3V
RP115L241D	DV24	2.4V
RP115L251D	DV25	2.5V
RP115L261D	DV26	2.6V
RP115L271D	DV27	2.7V
RP115L281D	DV28	2.8V
RP115L291D	DV29	2.9V
RP115L301D	DV30	3.0V
RP115L311D	DV31	3.1V
RP115L321D	DV32	3.2V
RP115L331D	DV33	3.3V
RP115L341D	DV34	3.4V
RP115L351D	DV35	3.5V
RP115L361D	DV36	3.6V
RP115L371D	DV37	3.7V
RP115L381D	DV38	3.8V
RP115L391D	DV39	3.9V
RP115L401D	DV40	4.0V
RP115L411D	DV41	4.1V
RP115L421D	DV42	4.2V
RP115L431D	DV43	4.3V
RP115L071D5	DV00	0.75V
RP115L121D5	DV01	1.25V
RP115L181D5	DV02	1.85V
RP115L281D5	DV03	2.85V
RP115L131D5	DV04	1.35V
RP115L111D5	DV05	1.15V
RP115L211D5	DV06	2.15V
RP115L291D5	DV60	2.95V
RP115L171D5	DV61	1.75V

# RP115x

NO. EA-274-150708

## Power Dissipation (SOT-89-5)

Power Dissipation ( $P_D$ ) depends on conditions of mounting on board. This specification is based on the Measurement Conditions below.

### Measurement Conditions

	High Wattage Land Pattern	Standard Land Pattern
Environment	Mounting on Board (Wind Velocity=0m/s)	Mounting on Board (Wind Velocity=0m/s)
Board Material	Glass Cloth Epoxy Plastic (Double-sided)	Glass Cloth Epoxy Plastic (Double-sided)
Board Dimensions	30mm x 30mm x 1.6mm	50mm x 50mm x 1.6mm
Copper Ratio	Topside: Approx. 20% Backside: Approx. 100%	Topside: Approx. 10% Backside: Approx. 100%
Through-hole	$\phi 0.85\text{mm} \times 10\text{pcs}$	-

### Measurement Result

( $T_a=25^\circ\text{C}$ )

	High Wattage Land Pattern	Standard Land Pattern	Free Air
Power Dissipation	1300mW	900mW ( $T_{j\text{max}}=125^\circ\text{C}$ ) 1125mW ( $T_{j\text{max}}=150^\circ\text{C}$ )	500mW
Thermal Resistance	$77^\circ\text{C/W}$	$111^\circ\text{C/W}$	$200^\circ\text{C/W}$



### Power Dissipation



Measurement Board Pattern

○ IC Mount Area Unit: mm

**Note:** The above graph shows the power dissipation of the package based on  $T_{j\text{max}}=125^\circ\text{C}$  and  $T_{j\text{max}}=150^\circ\text{C}$ . Operating the IC within the shaded area in The graph might have an influence on its lifetime. Operating time must be within the time limit described in the table below.

Operating Time	Estimated years (Operating four hours/day)
13,000 hours	9 years

**Package Dimensions (SOT-89-5)**

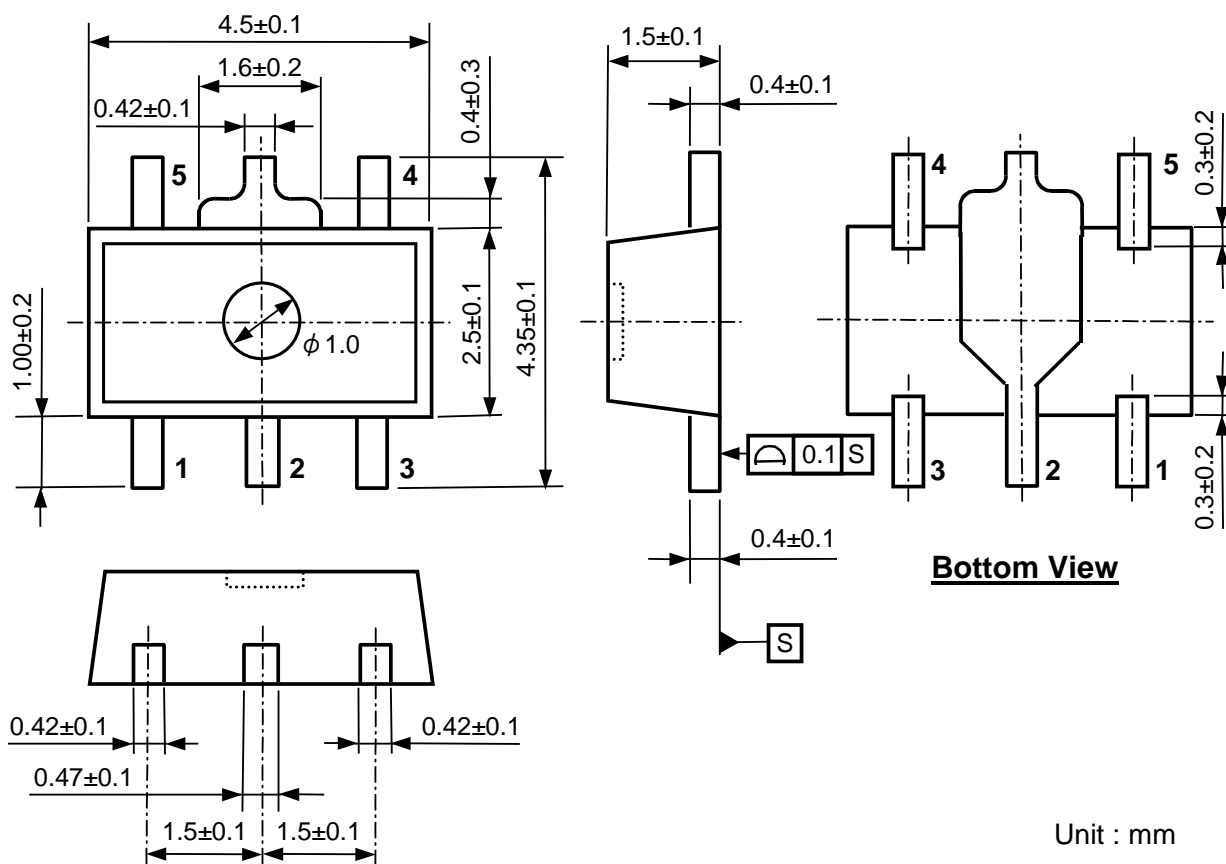

Unit : mm

**SOT-89-5 Package Dimensions**

**Mark Specification (SOT-89-5)**

①②③④: Product Code ... Please refer to RP115H Series Mark Specification Table.

⑤⑥: Lot Number ... Alphanumeric Serial Number

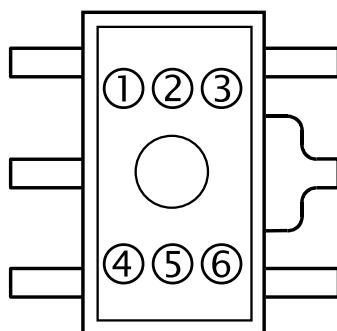

**SOT-89-5 Mark Specification**

---

**RP115x**NO. EA-274-150708

---

**Mark Specification Table (SOT-89-5)****RP115Hxx1B**

Product Name	①②③④	V <sub>SET</sub>
RP115H071B	D07F	0.7V
RP115H081B	D08F	0.8V
RP115H091B	D09F	0.9V
RP115H101B	D10F	1.0V
RP115H111B	D11F	1.1V
RP115H121B	D12F	1.2V
RP115H131B	D13F	1.3V
RP115H141B	D14F	1.4V
RP115H151B	D15F	1.5V
RP115H161B	D16F	1.6V
RP115H171B	D17F	1.7V
RP115H181B	D18F	1.8V
RP115H191B	D19F	1.9V
RP115H201B	D20F	2.0V
RP115H211B	D21F	2.1V
RP115H221B	D22F	2.2V
RP115H231B	D23F	2.3V
RP115H241B	D24F	2.4V
RP115H251B	D25F	2.5V
RP115H261B	D26F	2.6V
RP115H271B	D27F	2.7V
RP115H281B	D28F	2.8V
RP115H291B	D29F	2.9V
RP115H301B	D30F	3.0V
RP115H311B	D31F	3.1V
RP115H321B	D32F	3.2V
RP115H331B	D33F	3.3V
RP115H341B	D34F	3.4V
RP115H351B	D35F	3.5V
RP115H361B	D36F	3.6V
RP115H371B	D37F	3.7V
RP115H381B	D38F	3.8V
RP115H391B	D39F	3.9V
RP115H401B	D40F	4.0V
RP115H411B	D41F	4.1V
RP115H421B	D42F	4.2V
RP115H431B	D43F	4.3V
RP115H071B5	D00F	0.75V
RP115H121B5	D01F	1.25V
RP115H181B5	D02F	1.85V
RP115H281B5	D03F	2.85V
RP115H131B5	D04F	1.35V
RP115H111B5	D05F	1.15V
RP115H211B5	D06F	2.15V

**RP115Hxx1D**

Product Name	①②③④	V <sub>SET</sub>
RP115H071D	D07G	0.7V
RP115H081D	D08G	0.8V
RP115H091D	D09G	0.9V
RP115H101D	D10G	1.0V
RP115H111D	D11G	1.1V
RP115H121D	D12G	1.2V
RP115H131D	D13G	1.3V
RP115H141D	D14G	1.4V
RP115H151D	D15G	1.5V
RP115H161D	D16G	1.6V
RP115H171D	D17G	1.7V
RP115H181D	D18G	1.8V
RP115H191D	D19G	1.9V
RP115H201D	D20G	2.0V
RP115H211D	D21G	2.1V
RP115H221D	D22G	2.2V
RP115H231D	D23G	2.3V
RP115H241D	D24G	2.4V
RP115H251D	D25G	2.5V
RP115H261D	D26G	2.6V
RP115H271D	D27G	2.7V
RP115H281D	D28G	2.8V
RP115H291D	D29G	2.9V
RP115H301D	D30G	3.0V
RP115H311D	D31G	3.1V
RP115H321D	D32G	3.2V
RP115H331D	D33G	3.3V
RP115H341D	D34G	3.4V
RP115H351D	D35G	3.5V
RP115H361D	D36G	3.6V
RP115H371D	D37G	3.7V
RP115H381D	D38G	3.8V
RP115H391D	D39G	3.9V
RP115H401D	D40G	4.0V
RP115H411D	D41G	4.1V
RP115H421D	D42G	4.2V
RP115H431D	D43G	4.3V
RP115H071D5	D00G	0.75V
RP115H121D5	D01G	1.25V
RP115H181D5	D02G	1.85V
RP115H281D5	D03G	2.85V
RP115H131D5	D04G	1.35V
RP115H111D5	D05G	1.15V
RP115H211D5	D06G	2.15V

## TYPICAL CHARACTERISTICS

### 1) Output Voltage vs. Input Voltage ( $C_{IN}$ =Ceramic1.0 $\mu$ F, $C_{OUT}$ =Ceramic1.0 $\mu$ F, $T_a$ =25°C)



### 2) Supply Current vs. Input Voltage ( $C_{IN}$ =Ceramic1.0 $\mu$ F, $C_{OUT}$ =Ceramic1.0 $\mu$ F, $T_a$ =25°C)





**Short Current Limit vs. Temperature and Current Limit vs. Temperature**

The RP115x contains a peak current limit circuit which protect the regulator from damage by overcurrent if the output pin ( $V_{OUT}$ ) and the ground pin (GND) are shorted. The short-circuiting causes the overheating of the device which leads a thermal shutdown circuit to operate. If the peak current limit circuit and the thermal shutdown circuit work at the same time, fold-back type dropping characteristics cannot be measured. As for the short-circuit current and the peak current limit circuit, please refer to 3) Short Current Limit vs. Temperature and 4) Current Limit vs. Temperature.

**3) Short Current Limit vs. Temperature**

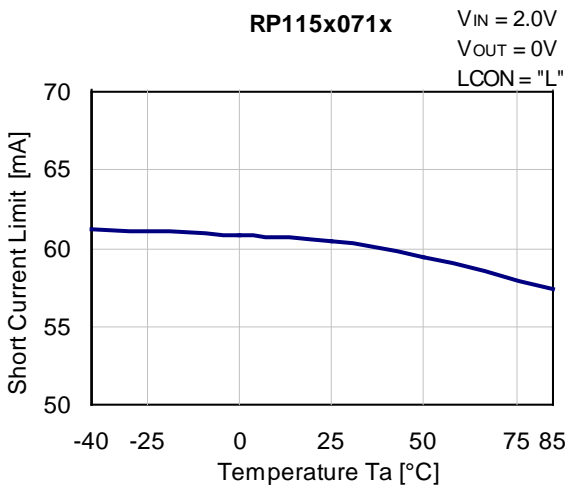

4) Peak Current Limit vs. Temperature



5) Output Voltage vs. Temperature ( $C_{IN}$ =Ceramic1.0 $\mu$ F,  $C_{OUT}$ =Ceramic1.0 $\mu$ F,  $I_{OUT}$ =1mA)

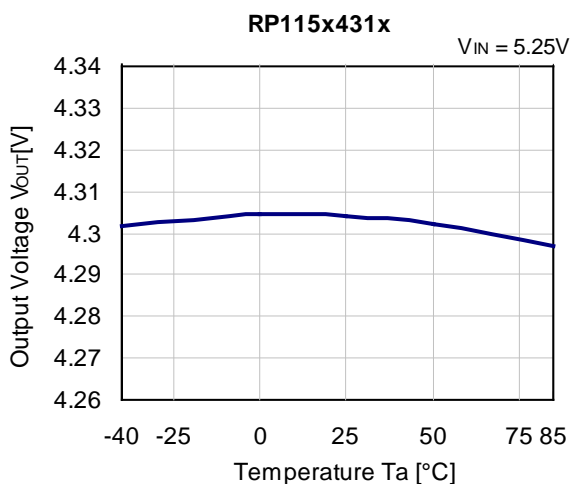
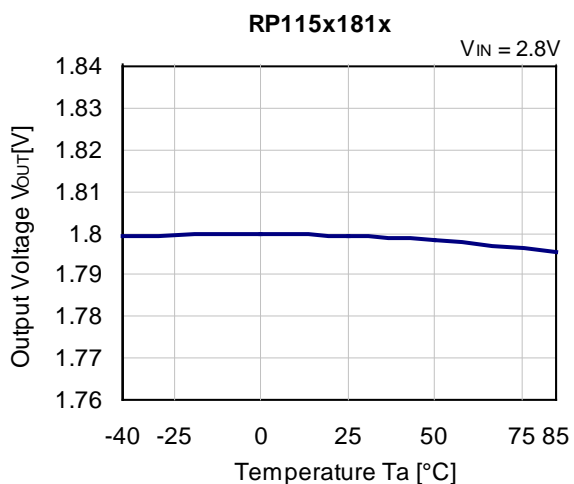

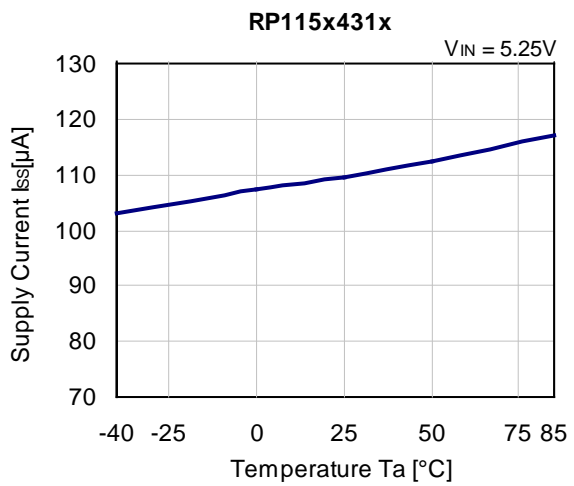
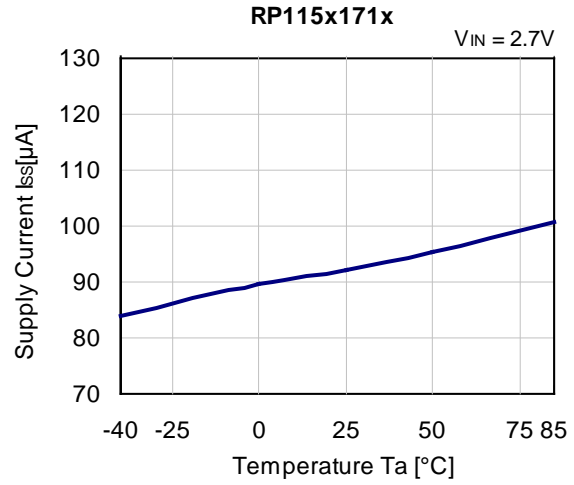
**6) Supply Current vs. Temperature ( $C_{IN}$ =Ceramic1.0 $\mu$ F,  $C_{OUT}$ =Ceramic1.0 $\mu$ F,  $I_{OUT}$ =0mA)**



7) Dropout Voltage vs. Output Current ( $C_{IN}$ =Ceramic1.0 $\mu$ F,  $C_{OUT}$ =Ceramic1.0 $\mu$ F)

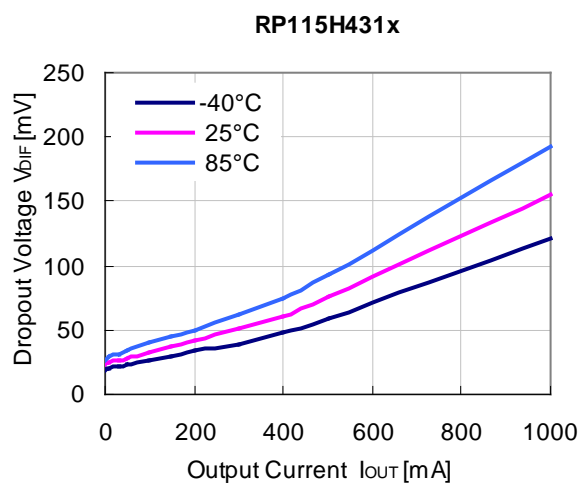
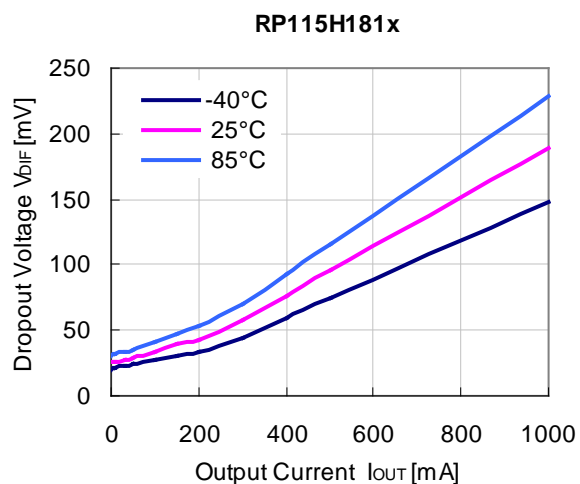
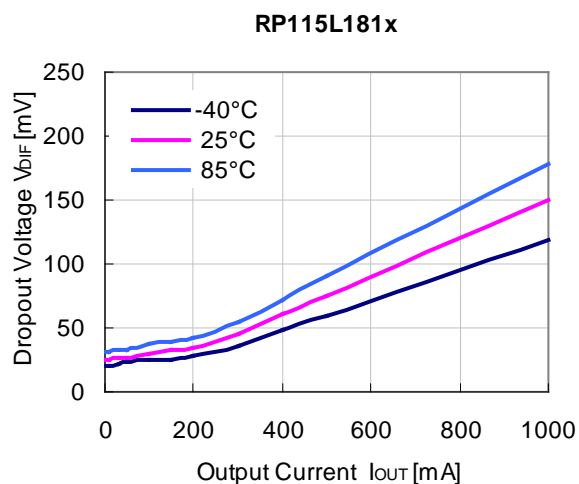
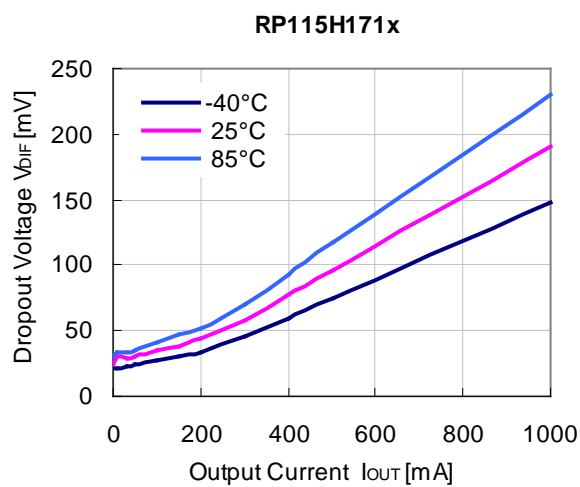

# RP115x

NO. EA-274-150708

## 8) Dropout Voltage vs. Set Output Voltage ( $C_{IN}$ =Ceramic1.0 $\mu$ F, $C_{OUT}$ =Ceramic1.0 $\mu$ F, $T_a$ =25 $^{\circ}$ C)



## 9) Dropout Voltage vs. Temperature ( $C_{IN}$ =Ceramic1.0 $\mu$ F, $C_{OUT}$ =Ceramic1.0 $\mu$ F)



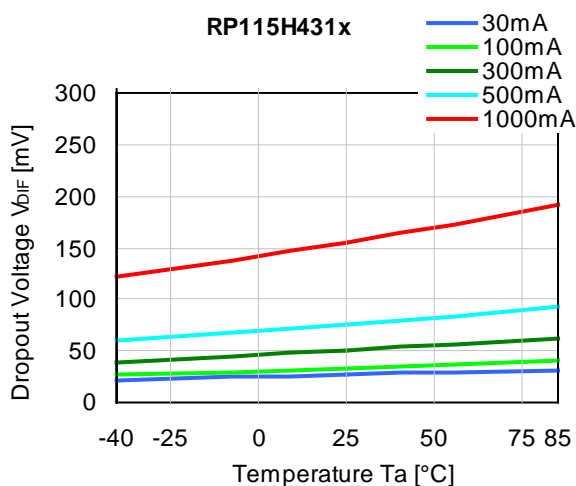
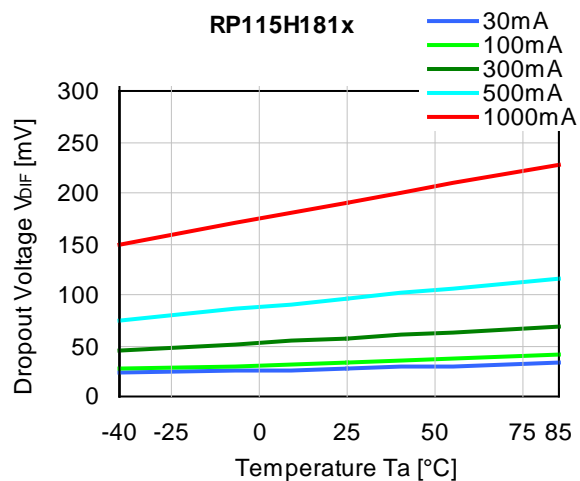
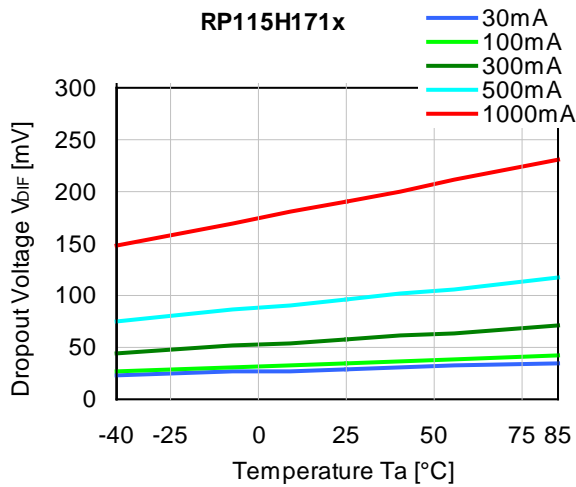
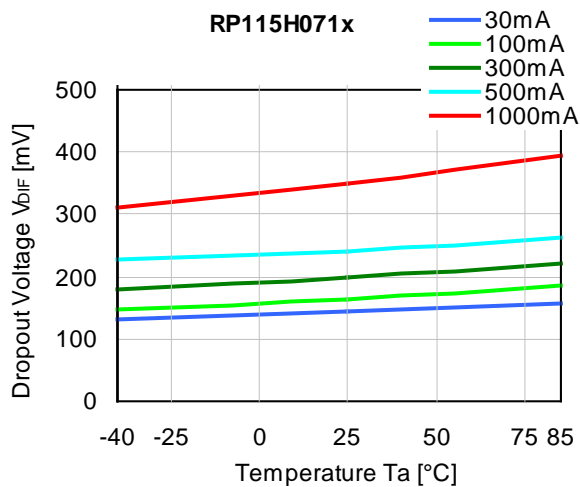

10) Ripple Rejection vs. Input Voltage ( $C_{IN}$ =none,  $C_{OUT}$ =Ceramic $1.0\mu F$ , Ripple=0.2Vp-p,  $T_a=25^\circ C$ )



# RP115x

NO. EA-274-150708

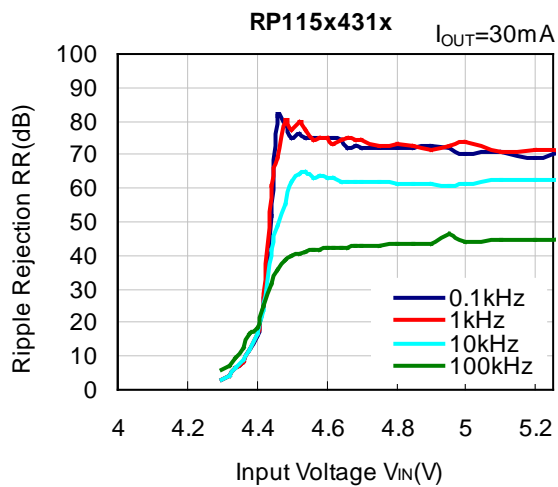
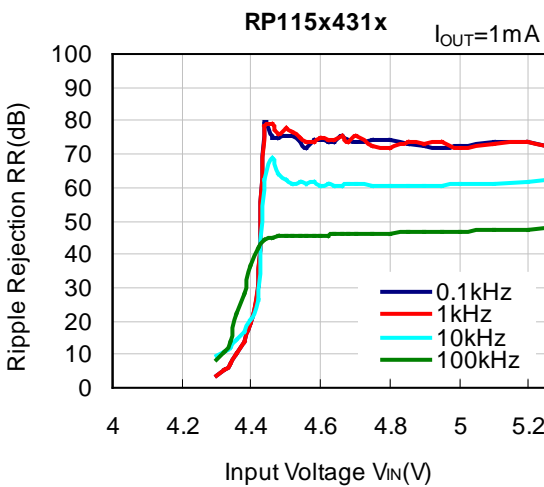
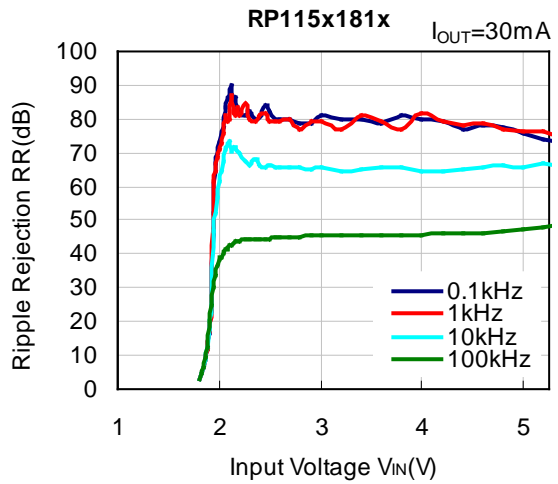
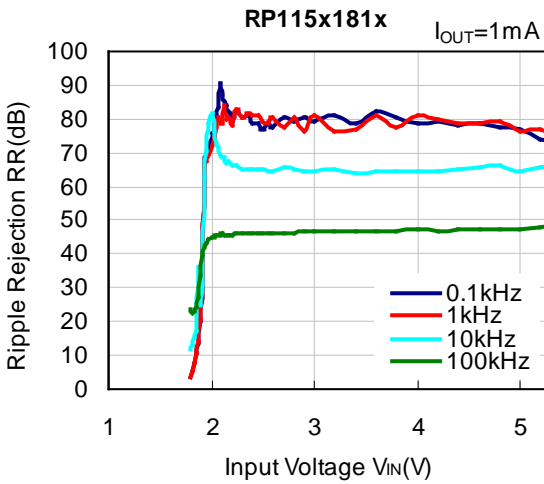
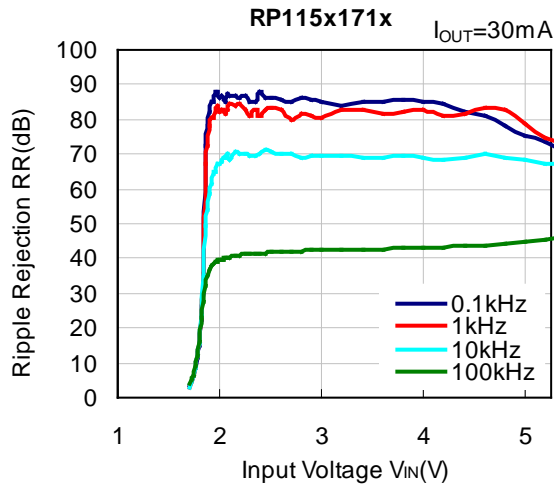
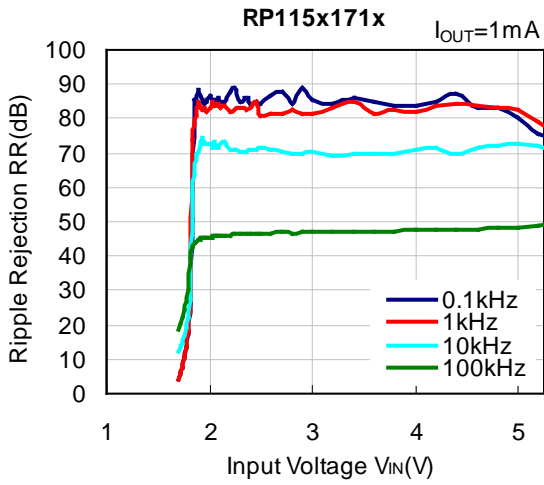

11) Ripple Rejection vs. Frequency ( $C_{IN}$ =none,  $C_{OUT}$ =Ceramic1.0 $\mu$ F, Ripple=0.2Vp-p,  $T_a$ =25°C)

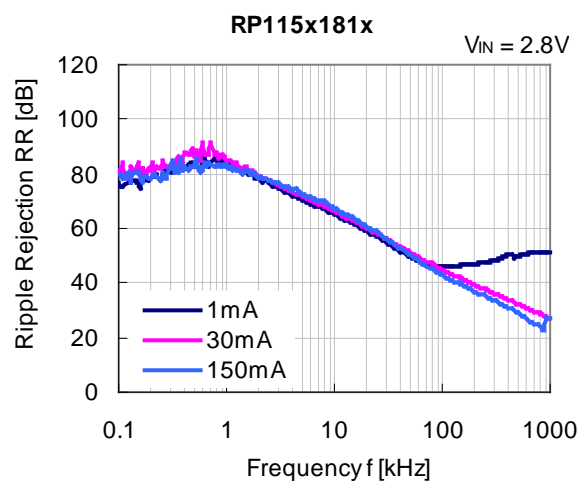
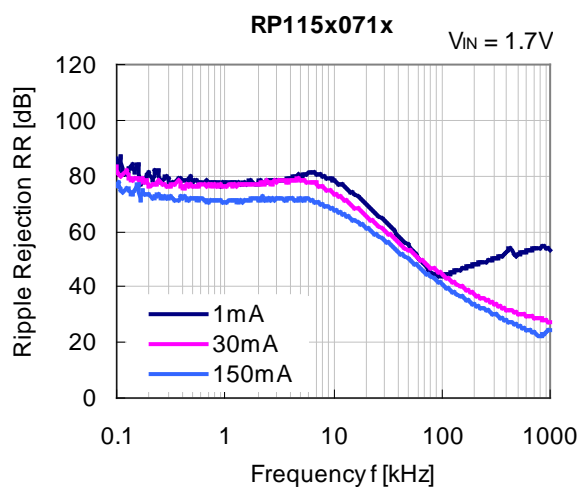

12) Line Transient Response ( $C_{IN}$ =none,  $C_{OUT}$ =Ceramic1.0 $\mu$ F,  $I_{OUT}$ =30mA,  $t_r$ = $t_f$ =5 $\mu$ s,  $T_a$ =25°C)

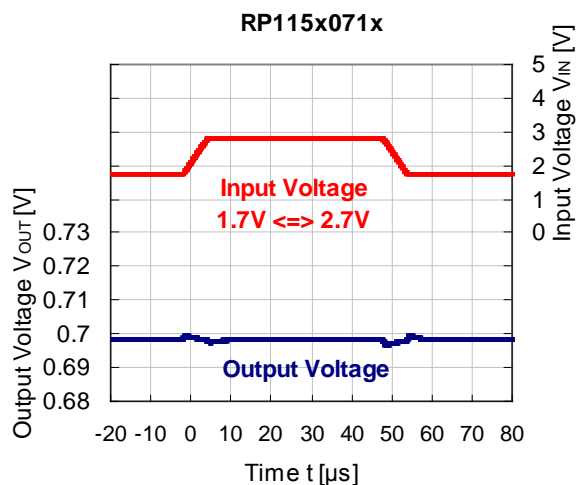



**13) Load Transient Response ( $C_{IN}$ =Ceramic1.0 $\mu$ F,  $C_{OUT}$ =Ceramic1.0 $\mu$ F,  $t_r=t_f$ =0.5 $\mu$ s,  $T_a$ =25°C)**

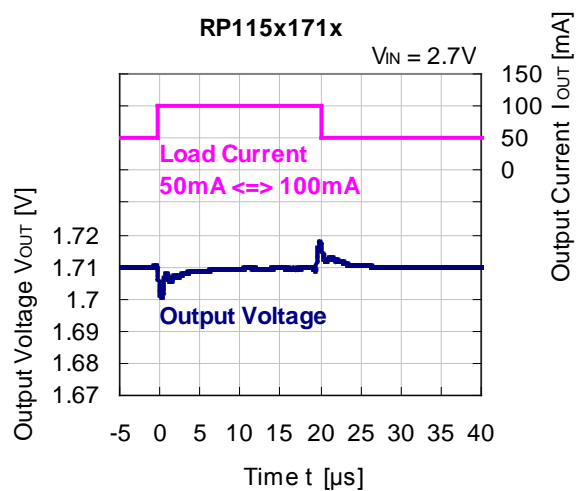
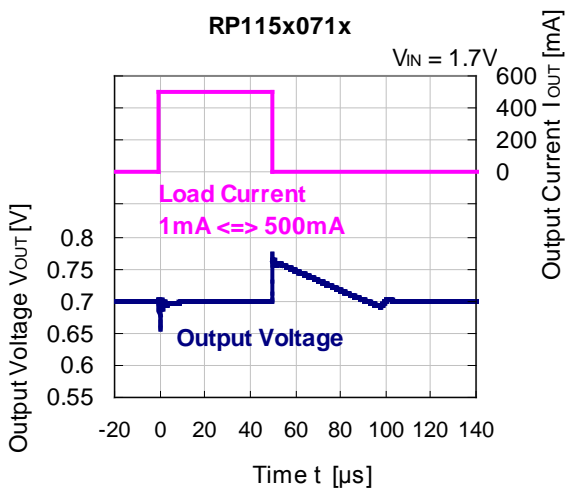
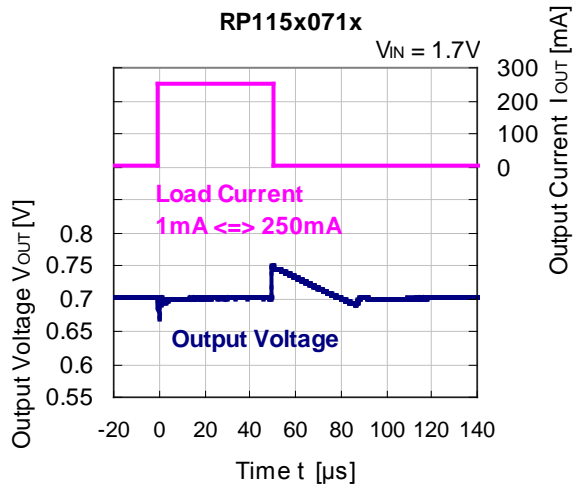
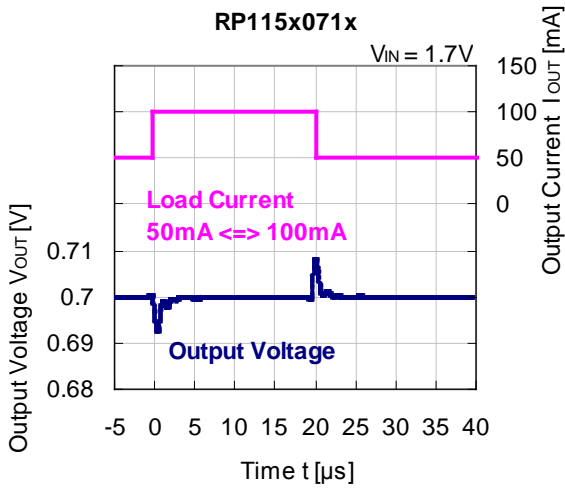

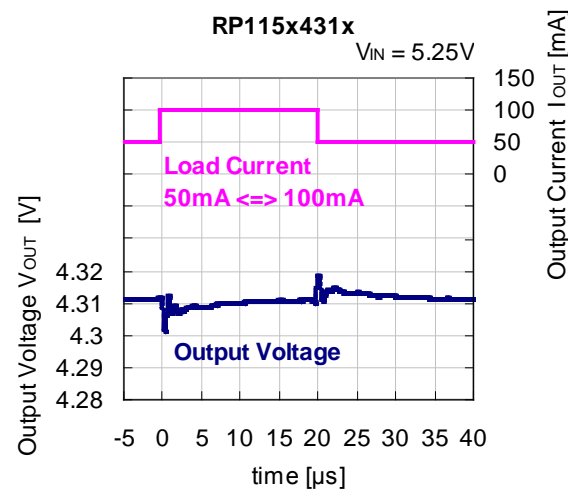
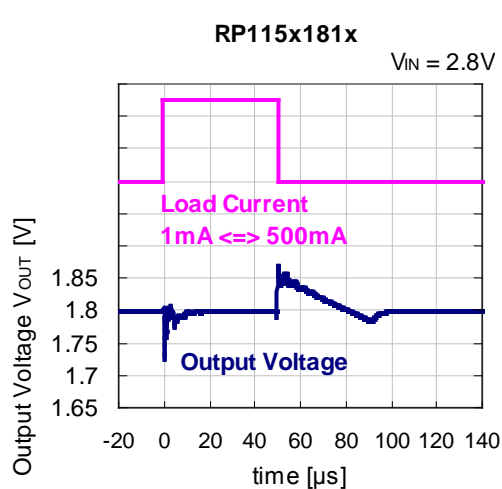
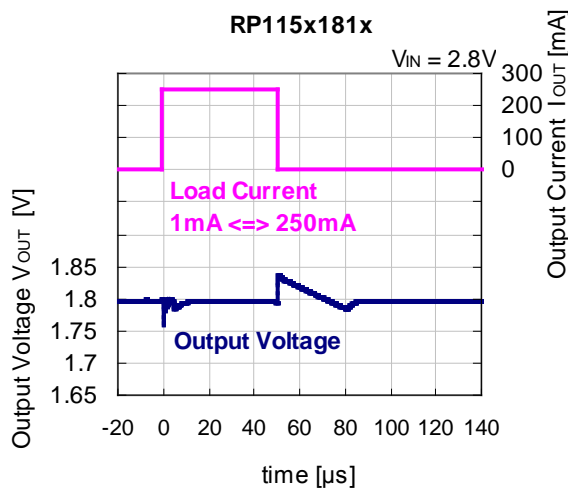
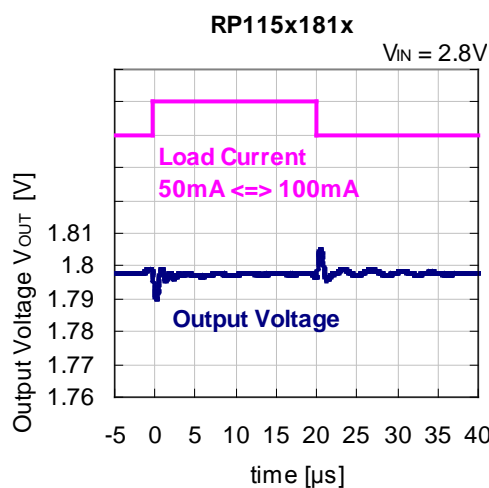
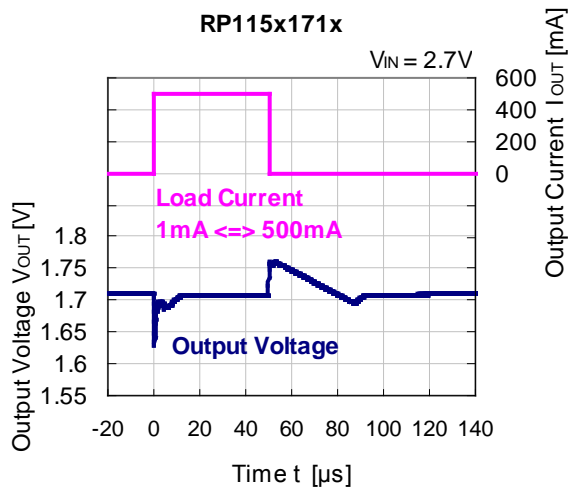
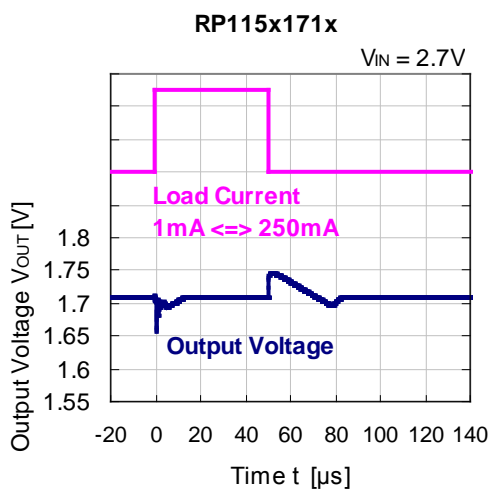

# RP115x

NO. EA-274-150708



## 14) Turn-on Waveform by CE Pin Signal ( $C_{IN}$ =Ceramic1.0 $\mu F$ , $C_{OUT}$ =Ceramic1.0 $\mu F$ , $T_a=25^\circ C$ )





15) Turn-off Waveform by CE Pin Signal ( $C_{IN}$ =Ceramic1.0 $\mu$ F,  $C_{OUT}$ =Ceramic1.0 $\mu$ F,  $T_a$ =25°C)



16) Inrush Current ( $C_{IN}$ =Ceramic $1.0\mu\text{F}$ ,  $I_{OUT}$ = $0\text{mA}$ ,  $T_a$ = $25^\circ\text{C}$ )



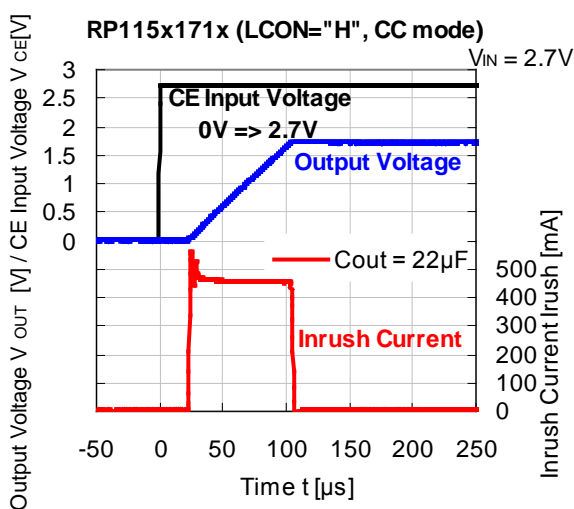
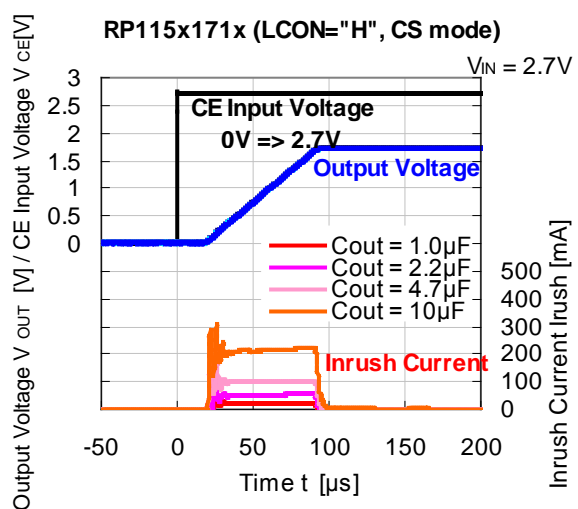
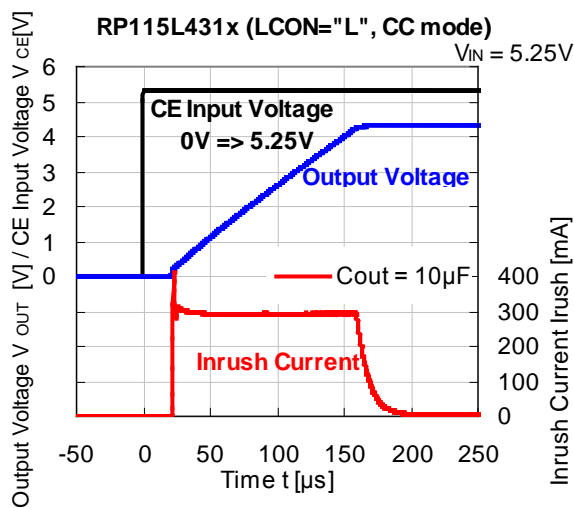
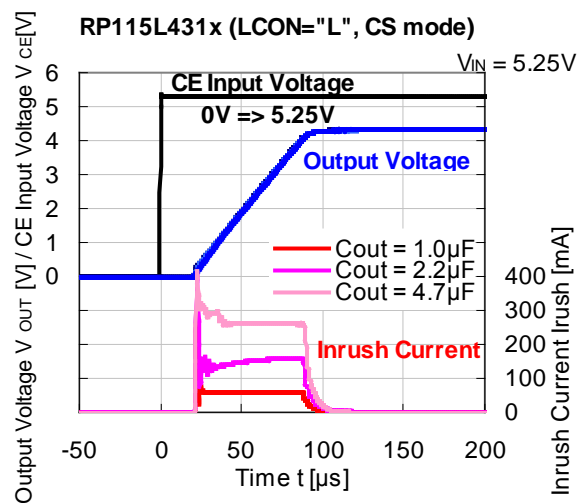

# RP115x

NO. EA-274-150708



17) LCON Pin Transient Response ( $C_{IN}$ =Ceramic1.0 $\mu$ F,  $C_{OUT}$ =Ceramic1.0 $\mu$ F,  $T_a$ =25°C)



## EQUIVALENT SERIES RESISTANCE (ESR) vs. OUTPUT CURRENT

Ceramic type output capacitor is recommended for the RP115x but any capacitor with low ESR can be used. The graphs below show the relation between  $I_{OUT}$  and ESR (noise level: average 40 $\mu$ V or less).

### Measurement Conditions

- Noise Frequency Band Width: 10Hz to 2MHz
- Operating Temperature Range:  $-40^{\circ}\text{C}$  to  $+85^{\circ}\text{C}$
- Hatched Area: Output noise level is average 40 $\mu$ V or less.
- $C_{IN}$ ,  $C_{OUT}$ : 1.0 $\mu$ F or more





1. The products and the product specifications described in this document are subject to change or discontinuation of production without notice for reasons such as improvement. Therefore, before deciding to use the products, please refer to Ricoh sales representatives for the latest information thereon.
2. The materials in this document may not be copied or otherwise reproduced in whole or in part without prior written consent of Ricoh.
3. Please be sure to take any necessary formalities under relevant laws or regulations before exporting or otherwise taking out of your country the products or the technical information described herein.
4. The technical information described in this document shows typical characteristics of and example application circuits for the products. The release of such information is not to be construed as a warranty of or a grant of license under Ricoh's or any third party's intellectual property rights or any other rights.
5. The products listed in this document are intended and designed for use as general electronic components in standard applications (office equipment, telecommunication equipment, measuring instruments, consumer electronic products, amusement equipment etc.). Those customers intending to use a product in an application requiring extreme quality and reliability, for example, in a highly specific application where the failure or misoperation of the product could result in human injury or death (aircraft, spacevehicle, nuclear reactor control system, traffic control system, automotive and transportation equipment, combustion equipment, safety devices, life support system etc.) should first contact us.
6. We are making our continuous effort to improve the quality and reliability of our products, but semiconductor products are likely to fail with certain probability. In order to prevent any injury to persons or damages to property resulting from such failure, customers should be careful enough to incorporate safety measures in their design, such as redundancy feature, fire containment feature and fail-safe feature. We do not assume any liability or responsibility for any loss or damage arising from misuse or inappropriate use of the products.
7. Anti-radiation design is not implemented in the products described in this document.
8. Please contact Ricoh sales representatives should you have any questions or comments concerning the products or the technical information.



**Ricoh is committed to reducing the environmental loading materials in electrical devices with a view to contributing to the protection of human health and the environment.**

Ricoh has been providing RoHS compliant products since April 1, 2006 and Halogen-free products since April 1, 2012.

**RICOH** RICOH ELECTRONIC DEVICES CO., LTD.

<http://www.e-devices.ricoh.co.jp/en/>

#### Sales & Support Offices

##### **RICOH ELECTRONIC DEVICES CO., LTD.**

**Higashi-Shinagawa Office (International Sales)**  
3-32-3, Higashi-Shinagawa, Shinagawa-ku, Tokyo 140-8655, Japan  
Phone: +81-3-5479-2857 Fax: +81-3-5479-0502

##### **RICOH EUROPE (NETHERLANDS) B.V.**

**Semiconductor Support Centre**  
Prof. W.H. Keesomlaan 1, 1183 DJ Amstelveen, The Netherlands  
Phone: +31-20-5474-309

##### **RICOH ELECTRONIC DEVICES KOREA CO., LTD.**

3F, Haesung Bldg. 504, Teheran-ro, Gangnam-gu, Seoul, 135-725, Korea  
Phone: +82-2-2135-5700 Fax: +82-2-2051-5713

##### **RICOH ELECTRONIC DEVICES SHANGHAI CO., LTD.**

Room 403, No.2 Building, No.690 Bilbo Road, Pu Dong New District, Shanghai 201203,  
People's Republic of China  
Phone: +86-21-5027-3200 Fax: +86-21-5027-3299

##### **RICOH ELECTRONIC DEVICES CO., LTD.**

**Taipei office**  
Room 109, 10F-1, No.51, Hengyang Rd., Taipei City, Taiwan (R.O.C.)  
Phone: +886-2-2313-1621/1622 Fax: +886-2-2313-1623

# Mouser Electronics

Authorized Distributor

Click to View Pricing, Inventory, Delivery & Lifecycle Information:

## Ricoh Electronics:

[RP115L111D-E2](#) [RP115L121D-E2](#) [RP115L291D5-E2](#) [RP115L281D-E2](#) [RP115L181D-E2](#) [RP115L181D5-E2](#)  
[RP115L401D-E2](#) [RP115L121D5-E2](#) [RP115L311D-E2](#) [RP115L431B-E2](#) [RP115L331D-E2](#) [RP115L301D-E2](#)  
[RP115L321D-E2](#) [RP115H231D-T1-FE](#) [RP115L291D-E2](#) [RP115H111D-T1-FE](#) [RP115L101D-E2](#) [RP115H191D-T1-FE](#)  
[RP115H301D-T1-FE](#) [RP115L341B-E2](#) [RP115L131D-E2](#) [RP115H101D-T1-FE](#) [RP115L181B5-E2](#) [RP115L331B-E2](#)  
[RP115L171D-E2](#) [RP115H121D8-T1-FE](#) [RP115L241B-E2](#) [RP115H351D-T1-FE](#) [RP115L181B-E2](#) [RP115L311B-E2](#)  
[RP115H131D-T1-FE](#) [RP115L321B-E2](#) [RP115L111D5-E2](#) [RP115L151D-E2](#)





Компания «ЭлектроПласт» предлагает заключение долгосрочных отношений при поставках импортных электронных компонентов на взаимовыгодных условиях!

Наши преимущества:

- Оперативные поставки широкого спектра электронных компонентов отечественного и импортного производства напрямую от производителей и с крупнейших мировых складов;
- Поставка более 17-ти миллионов наименований электронных компонентов;
- Поставка сложных, дефицитных, либо снятых с производства позиций;
- Оперативные сроки поставки под заказ (от 5 рабочих дней);
- Экспресс доставка в любую точку России;
- Техническая поддержка проекта, помощь в подборе аналогов, поставка прототипов;
- Система менеджмента качества сертифицирована по Международному стандарту ISO 9001;
- Лицензия ФСБ на осуществление работ с использованием сведений, составляющих государственную тайну;
- Поставка специализированных компонентов (Xilinx, Altera, Analog Devices, Intersil, Interpoint, Microsemi, Aeroflex, Peregrine, Syfer, Eurofarad, Texas Instrument, Miteq, Cobham, E2V, MA-COM, Hittite, Mini-Circuits, General Dynamics и др.);

Помимо этого, одним из направлений компании «ЭлектроПласт» является направление «Источники питания». Мы предлагаем Вам помощь Конструкторского отдела:

- Подбор оптимального решения, техническое обоснование при выборе компонента;
- Подбор аналогов;
- Консультации по применению компонента;
- Поставка образцов и прототипов;
- Техническая поддержка проекта;
- Защита от снятия компонента с производства.



#### Как с нами связаться

**Телефон:** 8 (812) 309 58 32 (многоканальный)

**Факс:** 8 (812) 320-02-42

**Электронная почта:** [org@eplast1.ru](mailto:org@eplast1.ru)

**Адрес:** 198099, г. Санкт-Петербург, ул. Калинина, дом 2, корпус 4, литера А.