

Overview

KEMET's PEH169 is a long-life electrolytic capacitor with outstanding reliability and electrical performance. The device has a polarized all-welded design, heavy duty screw terminals, extended cathode construction, safety vent, and plastic insulation. The PEH 169 winding is housed in a cylindrical aluminum can with a reinforced molded lid incorporating a safety vent. The sealing system is designed for electrolyte leakage-free operation and a very low gas-diffusion rate of electrolyte. Mechanical contact between the winding and case allows excellent heat transfer from the winding to the ambient, which means cooler operation. Low ESR is the result of a low resistive paper/electrolyte system, at least two tabs per foil and an all-welded design.

Applications

Typical applications for KEMET's PEH169 capacitor include smoothing, energy storage or pulse operation in telecommunication demanding power supplies, process control, AC motor control, traction, welding, and measuring.

Benefits

- High CV value
- Long life, up to 38,000 hours at +85°C (V_R, I_R applied)
- Low ESR and ESL
- High stability, 10 years shelf life
- Optimized designs available on request



Part Number System

PEH169	E		A	510	V	M	U2
Series	Rated Voltage (VDC)		Size Code	Capacitance Code (µF)	Version	Capacitance Tolerance	Stud Option
Screw Terminal Aluminum Electrolytic	E = 10 G = 16 H = 25 K = 40 M = 63 P = 100 Q = 160	R = 200 S = 250 U = 350 V = 400 O = 420 Y = 450	See Dimension Table	The last two digits represent significant figures. The first digit specifies the total number of digits.	0 = Standard	Q = -10 +30% M = ±20%	U2 = Plain Can B2 = Threaded mounting stud

Performance Characteristics

Item	Performance Characteristics		
Capacitance Range	68 – 470,000 μ F		
Rated Voltage	10 – 450 VDC		
Operating Temperature	-40 to +85°C		
Capacitance Tolerance	\pm 20%, (-10/+30% select values) at 100 Hz/+20°C		
Operational Lifetime	D (mm)	Rated Voltage and Ripple Current at +85°C (hours)	Rated Voltage at +85°C (hours)
	35	14,000	
	50	17,000	
	65	21,000	
	75	28,000	
	90	38,000	78,000
Shelf Life	5,000 hours at +85°C or 10 years at +40°C 0 VDC		
Leakage Current	$I = 0.003 CV + 4,000$ (μ A)		
	C = rated capacitance (μ F), V = rated voltage (VDC). Voltage applied for 5 minutes at +20°C.		
Vibration Test Specifications		Procedure	Requirements
	D \leq 50 mm	0.75 mm displacement amplitude or 10 g maximum acceleration. Vibration applied for three 2-hour sessions at 10 – 500 Hz (Capacitor clamped by body).	No leakage of electrolyte or other visible damage. Deviations in capacitance from initial measurements must not exceed: $\Delta C/C < 5\%$
D > 50 mm	0.75 mm displacement amplitude or 10 g maximum acceleration. Vibration applied for three 2-hour sessions at 10 – 55 Hz (Capacitor clamped by body).		
Standards	IEC 60384-4 long life grade 40/85/56, DIN 41240 type 1A CECC 30300, DIN 40040 GPF, DIN 41248		
CECC	CECC 30301-058, corresponding to CECC 30301-803		

Test Method & Performance

Endurance Life Test		
Conditions	Performance	
Temperature	+85°C	
Test Duration	5,000 hours	
Ripple Current	Maximum ripple current specified in table	
Voltage	The sum of DC voltage and the peak AC voltage must not exceed the rated voltage of the capacitor	
Performance	The following specifications will be satisfied when the capacitor is tested at +20°C:	
Capacitance Change	≤ 160 V	Within 15% of the initial value
	> 160 V	Within 10% of the initial value
Equivalent Series Resistance	Does not exceed 200% of the initial value	
Leakage Current	Does not exceed leakage current limit	

Dimensions – Millimeters

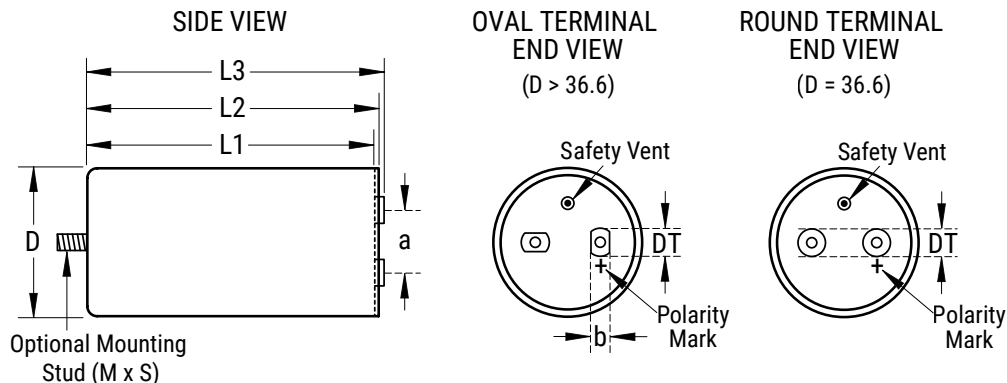

Reference Size (mm)	Size Code	Dimensions in mm					Mounting Stud (M x S)	Approximate Weight Grams
		D	L1	L2	L3	a		
		±1.0	±1.0	±1.0	±1.0	±0.5	Nominal	
35 x 51	A	36.6	51.5	54.5	58.9	13.0	M8 x 12	70
35 x 60	B	36.6	59.5	62.5	66.9	13.0	M8 x 12	85
35 x 75	C	36.6	73.5	76.5	80.9	13.0	M8 x 12	105
35 x 95	D	36.6	94.5	97.5	101.9	13.0	M8 x 12	130
50 x 75	H	51.6	74.5	77.5	82.4	22.0	M12 x 16	180
50 x 95	J	51.6	95.5	98.5	103.4	22.0	M12 x 16	240
50 x 105	K	51.6	103.5	106.5	111.4	22.0	M12 x 16	265
50 x 115	I*	51.6	115.5	118.5	123.4	22.0	M12 x 16	300
65 x 105	O	66.6	106.0	109.2	113.0	28.5	M12 x 16	415
65 x 115	Q*	66.6	118.0	121.2	125.0	28.5	M12 x 16	460.0
65 x 130	S*	66.6	129.0	132.2	136.0	28.5	M12 x 16	520.0
75 x 78	L	76.6	77.0	80.2	84.0	32.0	M12 x 16	430.0
75 x 98	P*	76.6	98.0	101.2	105.0	32.0	M12 x 16	530
75 x 105	T	76.6	106.0	109.2	113.0	32.0	M12 x 16	585
75 x 115	U	76.6	118.0	121.2	125.0	32.0	M12 x 16	640
75 x 145	V	76.6	146.0	149.2	153.0	32.0	M12 x 16	800
75 x 220	X	76.6	221.0	224.2	228.0	32.0	M12 x 16	1400
90 x 145	Y	91.6	145.5	148.7	152.4	32.0	M12 x 16	1400

Note: Dimensions include plastic insulation

*Additional case sizes available on request

Termination Table

Reference Diameter	Thread	Termination Style	Dimensions in mm	
			DT	b
35	M5	Round	8	
50	M5	Oval	15	13
65	M5	Oval	15	13
75	M5	Oval	15	13
90	M5	Oval	15	13

Note: M6 and other termination options available on request

Shelf Life

The capacitance, ESR and impedance of a capacitor will not change significantly after extended storage periods, however the leakage current will very slowly increase. KEMET products are particularly stable and allow a shelf life in excess of three years at 40°C. See sectional specification under each product series for specific data.

Re-age (Reforming) Procedure

Apply the rated voltage to the capacitor at room temperature for a period of one hour, or until the leakage current has fallen to a steady value below the specified limit. During re-aging a maximum charging current of twice the specified leakage current or 5 mA (whichever is greater) is suggested.

Reliability

The reliability of a component can be defined as the probability that it will perform satisfactorily under a given set of conditions for a given length of time.

In practice, it is impossible to predict with absolute certainty how any individual component will perform; thus, we must utilize probability theory. It is also necessary to clearly define the level of stress involved (e.g. operating voltage, ripple current, temperature and time). Finally, the meaning of satisfactory performance must be defined by specifying a set of conditions which determine the end of life of the component.

Reliability as a function of time, $R(t)$, is normally expressed as: $R(t) = e^{-\lambda t}$

where $R(t)$ is the probability that the component will perform satisfactorily for time t , and λ is the failure rate.

Failure Rate

The failure rate is the number of components failing per unit time. The failure rate of most electronic components follows the characteristic pattern:

- Early failures are removed during the manufacturing process.
- The operational life is characterized by a constant failure rate.
- The wear out period is characterized by a rapidly increasing failure rate.

The failures in time (FIT) are given with a 60% confidence level for the various type codes. By convention, FIT is expressed as 1×10^{-9} failures per hour. Failure rate is also expressed as a percentage of failures per 1,000 hours.

e.g., 100 FIT = 1×10^{-7} failures per hour = 0.01%/1,000 hours

End of Life Definition

Catastrophic Failure: short circuit, open circuit or safety vent operation

Parametric Failure:

- Change in capacitance $> \pm 10\%$
- Leakage current $>$ specified limit
- ESR $> 2 \times$ initial ESR value

MTBF

The mean time between failures (MTBF) is simply the inverse of the failure rate.

$$MTBF = 1/\lambda$$



The failure rate is derived from our periodic test results. The failure rate (λ_R) is, therefore, only given at test temperature for life tests. An estimation is also given at 60°C. The expected failure rate for this capacitor range is based on our periodic test results for capacitors with structural similarity.

T_a Failure Rate per Hour

60°C 100 FIT

Failure rate per hour includes both catastrophic and parametric failures.

Environmental Compliance



All Part Numbers in this datasheet are Reach and RoHS compliant and Halogen-Free.

As an environmentally conscious company, KEMET is working continuously with improvements concerning the environmental effects of both our capacitors and their production.

In Europe (RoHS Directive) and in some other geographical areas such as China, legislation has been put in place to prevent the use of some hazardous materials, such as lead (Pb), in electronic equipment. All products in this catalog are produced to help our customers' obligations to guarantee their products and fulfill these legislative requirements. The only material of concern in our products has been lead (Pb), which has been removed from all designs to fulfill the requirement of containing less than 0.1% of lead in any homogeneous material. KEMET will closely follow any changes in legislation worldwide and make any necessary changes in its products, whenever needed.

Some customer segments such as medical, military and automotive electronics may still require the use of lead in electrode coatings. To clarify the situation and distinguish products from each other, a special symbol is used on the packaging labels for RoHS compatible capacitors.

Due to customer requirements, there may appear additional markings such as lead-free (LF), or lead-free wires (LFW) on the label.

Table 1 – Ratings & Part Number Reference

VDC	Rated Capacitance	Size Code	Reference Size	Ripple Current Maximum			ESR Maximum		L _{ESL}	Part Number
				D x L (mm)	100 Hz 85°C (A)	10 kHz 50°C (A) ²	10 kHz 40°C (A)	100 Hz 20°C (mΩ)		
10	10000	A	35 x 51	8.6	26.0	16.8	34	28	12	PEH169EA510VM(1)
10	15000	A	35 x 51	10.0	28.3	18.9	24	20	12	PEH169EA515VM(1)
10	22000	B	35 x 60	11.9	32.3	22.1	18	15	12	PEH169EB522VM(1)
10	33000	C	35 x 75	14.6	37.6	27.2	12	10	12	PEH169EC533VM(1)
10	47000	D	35 x 95	16.1	38.9	29.0	10	9	12	PEH169ED547VM(1)
10	68000	H	50 x 75	17.4	42.3	29.8	9	8	16	PEH169EH568VM(1)
10	100000	J	50 x 95	20.1	47.1	34.3	7	6	16	PEH169EJ610VM(1)
10	150000	K	50 x 105	20.7	47.4	34.7	7	7	16	PEH169EK615VM(1)
10	220000	O	65 x 105	21.9	48.2	36.0	8	8	16	PEH169EO622VM(1)
10	330000	U	75 x 115	31.4	68.1	51.9	5	4	4	PEH169EU633VM(1)
10	470000	V	75 x 145	33.6	71.0	55.5	4	4	17	PEH169EV647VM(1)
16	10000	A	35 x 51	9.1	27.4	18.3	28	22	12	PEH169GA510VM(1)
16	15000	A	35 x 51	10.5	30.8	20.5	19	15	12	PEH169GA515VM(1)
16	22000	C	35 x 75	13.2	36.2	25.7	14	11	12	PEH169GC522VM(1)
16	33000	D	35 x 95	15.4	39.7	29.4	10	8	12	PEH169GD533VM(1)
16	47000	H	50 x 75	17.8	42.6	30.6	10	8	16	PEH169GH547VM(1)
16	68000	J	50 x 95	20.2	47.0	34.6	7	7	16	PEH169GJ568VM(1)
16	100000	O	65 x 105	23.3	52.2	39.6	8	7	16	PEH169GO610VM(1)
16	150000	T	75 x 105	31.2	68.5	53.0	5	5	17	PEH169GT615VM(1)
16	220000	U	75 x 115	31.6	69.2	52.9	5	4	17	PEH169GU622VM(1)
16	330000	V	75 x 145	33.5	69.5	55.8	4	4	17	PEH169GV633VM(1)
25	6000	A	35 X 51	8.7	8.38	6.40	37	27	12	PEH169HA460AQ(1)
25	6800	A	35 x 51	8.3	27.4	18.3	30	22	12	PEH169HA468VM(1)
25	10000	A	35 x 51	9.6	30.7	20.1	24	18	12	PEH169HA510VM(1)
25	15000	C	35 x 75	12.3	36.2	25.7	15	11	12	PEH169HC515VM(1)
25	22000	D	35 x 95	14.3	39.5	29.3	11	8	12	PEH169HD522VM(1)
25	33000	H	50 x 75	16.3	42.4	29.8	10	8	16	PEH169HH533VM(1)
25	47000	J	50 x 95	19.0	47.0	34.4	8	7	16	PEH169HJ547VM(1)
25	68000	O	65 x 105	21.6	49.6	37.3	8	7	16	PEH169HO568VM(1)
25	100000	T	75 x 105	30.1	61.2	52.2	5	5	17	PEH169HT610VM(1)
25	150000	U	75 x 115	31.1	69.8	53.1	5	4	17	PEH169HU615VM(1)
25	220000	V	75 x 145	33.1	71.0	55.9	4	4	17	PEH169HV622VM(1)
40	4700	A	35 x 51	7.7	28.3	18.9	32	20	12	PEH169KA447VM(1)
40	6800	B	35 x 60	9.0	30.4	21.1	23	15	12	PEH169KB468VM(1)
40	10000	C	35 x 75	10.9	33.7	24.5	18	13	12	PEH169KC510VM(1)
40	15000	D	35 x 95	13.0	37.5	28.6	11	8	12	PEH169KD515VM(1)
40	22000	H	50 x 75	16.3	45.3	32.0	11	8	16	PEH169KH522VM(1)
40	33000	J	50 x 95	17.8	46.3	32.9	9	8	16	PEH169KJ533VM(1)
40	47000	O	65 x 105	21.7	50.7	38.7	8	7	16	PEH169KO547VM(1)
40	68000	T	75 x 105	28.8	63.6	51.3	5	5	17	PEH169KT568VM(1)
40	100000	U	75 x 115	29.7	68.1	51.6	5	4	17	PEH169KU610VM(1)
40	150000	V	75 x 145	32.0	69.5	55.1	4	4	17	PEH169KV615VM(1)
63	2200	A	35 x 51	5.9	25.1	17.1	46	24	12	PEH169MA422VM(1)
63	3300	A	35 x 51	7.1	31.1	19.4	30	15	12	PEH169MA433VM(1)
63	4700	C	35 x 75	8.8	33.2	23.9	23	12	12	PEH169MC447VM(1)
63	6800	D	35 x 95	10.1	34.9	27.0	17	9	12	PEH169MD468VM(1)
63	10000	H	50 x 75	13.3	40.2	29.3	14	9	16	PEH169MH510VM(1)
63	15000	J	50 x 95	15.7	44.0	33.5	11	7	16	PEH169MJ515VM(1)
63	22000	K	50 x 105	17.9	48.2	35.8	9	7	16	PEH169MK522VM(1)
63	33000	T	75 x 105	27.5	71.3	54.4	6	5	17	PEH169MT533VM(1)
63	47000	U	75 x 115	29.6	73.0	55.9	5	4	17	PEH169MU547VM(1)
63	68000	V	75 x 145	30.0	68.8	54.2	5	4	17	PEH169MV568VM(1)
63	68000	V	75 x 145	29.4	65.0	52.6	6	5	17	PEH169MV568AQ(1)
63	82000	V	75 x 145	28.2	66.7	49.7	5	4	17	PEH169MV582BQ(1)
100	1000	A	35 x 51	4.1	16.4	11.1	120	75	12	PEH169PA410VM(1)
100	1500	A	35 x 51	5.0	19.5	13.1	80	51	12	PEH169PA415VM(1)
100	2200	C	35 x 75	6.1	21.5	15.5	61	41	12	PEH169PC422VM(1)
100	3300	D	35 x 95	7.4	24.3	18.3	42	29	12	PEH169PD433VM(1)
VDC	Rated Capacitance	Size Code	Reference Size	Ripple Current			ESR		L _{ESL}	Part Number

(1) Mounting Code: U2 = plain can, B2 = threaded mounting stud

² 2 m/s forced air, studmounted on 3°C/W aluminum chassis.

Table 1 – Ratings & Part Number Reference cont.

VDC	Rated Capacitance	Size Code	Reference Size	Ripple Current Maximum			ESR Maximum		L _{ESL} Approximate (nH)	Part Number
				100 Hz 85°C (A)	10 kHz 50°C (A) ²	10 kHz 40°C (A)	100 Hz 20°C (mΩ)	100 kHz 20°C (mΩ)		
100	4700	H	50 x 75	10.5	34.4	24.3	31	22	16	PEH169PH447VM(1)
100	6800	J	50 x 95	12.6	39.2	28.7	22	15	16	PEH169PJ468VM(1)
100	10000	K	50 x 105	13.9	38.6	29.1	17	13	16	PEH169PK510VM(1)
100	15000	O	65 x 105	18.4	48.5	36.3	13	10	16	PEH169PO515VM(1)
100	22000	U	75 x 115	25.4	67.3	51.3	8	6	17	PEH169PU522VM(1)
100	33000	V	75 x 145	28.5	71.0	55.2	6	5	17	PEH169PV533VM(1)
100	33000	V	75 x 145	27.3	67.3	51.5	7	6	17	PEH169PV533AQ(1)
160	470	A	35 x 51	2.5	13.6	9.0	240	110	12	PEH169QA347VM(1)
160	680	A	35 x 51	3.0	14.3	9.7	190	98	12	PEH169QA368VM(1)
160	1000	C	35 x 75	3.9	17.2	12.2	130	66	12	PEH169QC410VM(1)
160	1500	D	35 x 95	4.7	19.4	14.7	87	45	12	PEH169QD415VM(1)
160	2200	H	50 x 75	6.7	26.5	18.1	59	31	16	PEH169QH422VM(1)
160	3300	J	50 x 95	8.2	30.6	22.9	44	24	16	PEH169QJ433VM(1)
160	4700	O	65 x 105	10.9	35.8	26.8	31	17	16	PEH169QO447VM(1)
160	6800	T	75 x 105	14.6	50.2	37.2	21	12	17	PEH169QT468VM(1)
160	10000	U	75 x 115	17.0	53.6	41.7	16	10	17	PEH169QU510VM(1)
160	15000	V	75 x 145	19.6	58.2	43.4	12	7	17	PEH169QV515VM(1)
200	470	A	35 x 51	2.6	13.4	9.2	240	110	12	PEH169RA347VM(1)
200	680	B	35 x 60	3.3	15.2	11.1	170	79	12	PEH169RB368VM(1)
200	1000	D	35 x 95	4.0	18.9	13.9	110	53	12	PEH169RD410VM(1)
200	1500	H	50 x 75	5.8	24.0	18.1	79	40	16	PEH169RH415VM(1)
200	2200	J	50 x 95	7.0	28.3	21.5	55	28	16	PEH169RJ422VM(1)
200	3300	K	50 x 105	8.5	32.1	24.3	39	21	16	PEH169RK433VM(1)
200	4700	O	65 x 105	11.0	35.5	27.1	35	22	16	PEH169RO447VM(1)
200	6800	T	75 x 105	14.6	48.1	36.2	23	15	17	PEH169RT468VM(1)
200	10000	V	75 x 145	17.3	52.0	41.3	17	11	17	PEH169RV510VM(1)
250	220	A	35 x 51	1.8	8.4	6.0	500	260	12	PEH169SA322VM(1)
250	330	A	35 x 51	2.2	10.6	7.3	340	170	12	PEH169SA333VM(1)
250	470	B	35 x 60	2.7	11.9	8.7	240	130	12	PEH169SB347VM(1)
250	680	C	35 x 75	3.3	14.8	10.7	170	88	12	PEH169SC368VM(1)
250	1000	H	50 x 75	4.9	20.5	14.9	110	61	16	PEH169SH410VM(1)
250	1500	H	50 x 75	6.0	24.2	16.7	81	45	16	PEH169SH415VM(1)
250	2200	K	50 x 105	7.3	27.3	21.0	55	31	16	PEH169SK422VM(1)
250	3300	O	65 x 105	10.0	34.5	26.8	40	23	16	PEH169SO433VM(1)
250	4700	T	75 x 105	13.3	45.6	34.8	27	16	17	PEH169ST447VM(1)
250	6800	V	75 x 145	15.8	50.6	40.3	19	11	17	PEH169SV468VM(1)
250	6800	V	75 x 145	16.1	53.2	41.9	17	9	17	PEH169SV468AQ(1)
250	8800	V	75 x 145	17.3	60.6	45.9	15	9	17	PEH169SV488AM(1)
250	10000	X	75 x 220	17.3	50.7	43.2	14	9	17	PEH169SX510VM(1)
250	10000	Y	90 x 145	20.5	58.2	47.6	15	10	16	PEH169SY510VM(1)
350	150	A	35 x 51	1.6	7.6	5.0	630	340	12	PEH169UA315VM(1)
350	220	A	35 x 51	2.0	9.3	6.3	440	240	12	PEH169UA322VM(1)
350	330	C	35 x 75	2.5	10.8	7.8	290	160	12	PEH169UC333VM(1)
350	470	D	35 x 95	3.0	12.6	9.2	200	110	12	PEH169UD347VM(1)
350	680	H	50 x 75	4.4	18.2	13.4	140	80	16	PEH169UH368VM(1)
350	1000	J	50 x 95	5.3	20.8	16.1	99	55	16	PEH169UJ410VM(1)
350	1500	K	50 x 105	6.7	25.5	19.2	68	39	16	PEH169UK415VM(1)
350	2200	O	65 x 105	9.2	32.2	24.7	49	29	16	PEH169UO422VM(1)
350	3300	T	75 x 105	12.4	42.8	32.8	33	20	17	PEH169UT433VM(1)
350	4700	V	75 x 145	14.5	48.0	38.0	23	14	17	PEH169UV447VM(1)
350	6800	X	75 x 220	15.9	47.1	39.2	18	11	17	PEH169UX468VM(1)
350	6800	Y	90 x 145	18.9	53.7	43.7	19	13	16	PEH169UY468VM(1)
400	100	A	35 x 51	1.5	7.2	4.9	740	360	12	PEH169VA3100Q(1)
400	100	A	35 x 51	1.5	7.8	5.3	700	320	12	PEH169VA310VM(1)
400	150	B	35 x 60	1.8	8.7	6.3	500	240	12	PEH169VB3150Q(1)
400	150	A	35 x 51	1.8	9.4	6.3	470	220	12	PEH169VA315VM(1)
400	220	C	35 x 75	2.2	10.1	7.5	350	170	12	PEH169VC3220Q(1)
400	220	B	35 x 60	2.2	9.8	6.8	370	200	12	PEH169VB322VM(1)
VDC	Rated Capacitance	Size Code	Reference Size	Ripple Current			ESR		L _{ESL}	Part Number

(1) Mounting Code: U2 = plain can, B2 = threaded mounting stud

² 2 m/s forced air, studmounted on 3°C/W aluminum chassis.

Table 1 – Ratings & Part Number Reference cont.

VDC	Rated Capacitance	Size Code	Reference Size	Ripple Current Maximum			ESR Maximum		L _{ESL} Approximate (nH)	Part Number
	100 Hz 20°C (µF)		D x L (mm)	100 Hz 85°C (A)	10 kHz 50°C (A) ²	10 kHz 40°C (A)	100 Hz 20°C (mΩ)	100 kHz 20°C (mΩ)		
400	330	H	50 x 75	3.3	15.1	11.3	230	110	16	PEH169VH3330Q(1)
400	330	C	35 x 75	2.8	12.2	8.9	250	130	12	PEH169VC333VM(1)
400	470	H	50 x 75	4.0	18.9	13.5	160	78	16	PEH169VH3470Q(1)
400	470	H	50 x 75	4.1	18.7	14.0	150	73	16	PEH169VH347VM(1)
400	680	K	50 x 105	4.9	20.3	15.4	120	59	16	PEH169VK3680Q(1)
400	1000	K	50 x 105	5.8	23.0	17.6	85	47	16	PEH169VK410VM(1)
400	1000	O	65 x 105	6.8	26.9	21.2	79	41	16	PEH169VO4100Q(1)
400	1500	T	75 x 105	9.2	36.7	28.6	53	27	17	PEH169VT4150Q(1)
400	1500	O	65 x 105	8.2	30.8	23.8	58	32	16	PEH169VO415VM(1)
400	2200	P	75 x 98	11.2	48.4	36.2	35	17	17	PEH169VP422AM(1)
400	2200	V	75 x 145	11.0	41.8	34.0	36	18	17	PEH169VV4220Q(1)
400	2200	T	75 x 105	10.9	40.1	31.0	40	23	17	PEH169VT422VM(1)
400	3300	V	75 x 145	13.9	50.4	40.7	22	11	17	PEH169VV433GQ(1)
400	3300	V	75 x 145	13.3	46.0	37.3	27	15	17	PEH169VV433VM(1)
400	4700	X	75 x 220	13.8	38.5	33.8	24	16	17	PEH169VX447VM(1)
400	4700	Y	90 x 145	16.8	48.1	39.3	25	17	16	PEH169VY447VM(1)
420	68	A	35 x 51	1.0	4.5	3.2	1000	500	12	PEH1690A2680M(1)
420	100	B	35 x 60	1.2	5.5	4.0	700	340	12	PEH1690B3100M(1)
420	150	C	35 x 75	1.5	6.6	5.0	470	230	12	PEH1690C3150M(1)
420	220	D	35 x 95	1.8	7.5	5.9	320	160	12	PEH1690D3220M(1)
420	330	H	50 x 75	2.8	12.7	9.3	210	110	16	PEH1690H3330M(1)
420	470	J	50 x 95	3.4	14.4	11.0	150	75	16	PEH1690J3470M(1)
420	680	K	50 x 105	4.1	17.5	13.3	110	53	16	PEH1690K3680M(1)
420	1000	O	65 x 105	5.8	23.3	17.9	73	38	16	PEH1690O4100M(1)
420	1500	T	75 x 105	7.9	31.6	24.1	49	25	17	PEH1690T4150M(1)
420	2200	V	75 x 145	9.3	35.2	28.1	34	18	17	PEH1690V4220M(1)
420	3300	X	75 x 220	10.0	32.9	28.3	23	12	17	PEH1690X4330M(1)
420	3300	Y	90 x 145	12.9	44.1	36.0	24	13	16	PEH1690Y4330M(1)
450	68	A	35 x 51	1.0	3.7	2.9	1140	690	12	PEH169YA2680M(1)
450	100	B	35 x 60	1.3	4.4	3.6	800	490	12	PEH169YB3100M(1)
450	150	C	35 x 75	1.5	5.5	3.9	630	420	12	PEH169YC3150M(1)
450	220	D	35 x 95	1.8	5.1	4.6	440	300	12	PEH169YD3220M(1)
450	330	H	50 x 75	3.0	9.9	8.5	230	140	16	PEH169YH3330M(1)
450	470	J	50 x 95	3.8	11.8	10.1	170	100	16	PEH169YJ3470M(1)
450	680	K	50 x 105	4.2	12.2	10.5	140	96	16	PEH169YK3680M(1)
450	1000	O	65 x 105	6.4	18.5	16.0	82	52	16	PEH169YO4100M(1)
450	1500	T	75 x 105	7.8	21.7	18.7	67	47	17	PEH169YT4150M(1)
450	2200	V	75 x 145	9.4	25.4	22.7	45	31	17	PEH169YV4220M(1)
450	3300	X	75 x 220	10.2	25.0	23.8	34	24	17	PEH169YX4330M(1)
450	3300	Y	90 x 145	12.6	30.9	28.3	35	25	16	PEH169YY4330M(1)
VDC	Rated Capacitance	Size Code	Reference Size	Ripple Current			ESR		L _{ESL}	Part Number

(1) Mounting Code: U2 = plain can, B2 = threaded mounting stud

² 2 m/s forced air, studmounted on 3°C/W aluminum chassis.

Mechanical Data

Polarity and Reversed Voltage

Aluminium Electrolytic capacitors manufactured for use in DC applications contain an anode foil and a cathode foil. As such, they are polarized devices and must be connected with the +ve to the anode foil and the -ve to the cathode foil. If this were to be reversed then the electrolytic process that took place in forming the oxide layer on the anode would be recreated in trying to form an oxide layer on the cathode. In forming the cathode foil in this way, heat would be generated and gas given off within the capacitor, usually leading to catastrophic failure.

The cathode foil already possesses a thin stabilized oxide layer. This thin oxide layer is equivalent to a forming voltage of approximately 2 V. As a result, the capacitor can withstand a voltage reversal of up to 2 V for short periods. Above this voltage, the formation process will commence. Aluminium Electrolytic capacitors can also be manufactured for use in intermittent AC applications by using two anode foils in place of one anode and one cathode.

Mounting Position

The capacitor can be mounted upright or inclined to a horizontal position.

Clamp Fixing

Clips must be ordered separately.

Stud Fixing

Nylon cap nut must be ordered separately. For the stud fixing insulated version, the outer insulation serves as lock washer.

Maximum tightening torque:

M8 = 3 Nm

M12= 8 Nm

Maximum chassis thickness 5 mm.

Screw Terminals

M5 x 10 according to DIN 41.248.

Maximum tightening torque = 2.5 Nm.

Must be ordered separately.

Recommended maximum connector thickness with delivered screw = 4 mm. M6 thread upon request.

Insulating Cup

PEH169 is supplied with a 0.8 mm thick polypropylene insulating cup. Voltage proof of the insulating cup: $\geq 4,000$ VDC

Marking



Construction



Construction Data

The manufacturing process begins with the anode foil being electrochemically etched to increase the surface area and then “formed” to produce the aluminum oxide layer. Both the anode and cathode foils are then interleaved with absorbent paper and wound into a cylinder. During the winding process, aluminum tabs are attached to each foil to provide the electrical contact.

The deck, complete with terminals, is attached to the tabs and then folded down to rest on top of the winding. The complete winding is impregnated with electrolyte before being housed in a suitable container, usually an aluminum can, and sealed. Throughout the process, all materials inside the housing must be maintained at the highest purity and be compatible with the electrolyte.

Each capacitor is aged and tested before being sleeved and packed. The purpose of aging is to repair any damage in the oxide layer and thus reduce the leakage current to a very low level. Aging is normally carried out at the rated temperature of the capacitor and is accomplished by applying voltage to the device while carefully controlling the supply current. The process may take several hours to complete.

Damage to the oxide layer can occur due to variety of reasons:

- Slitting of the anode foil after forming
- Attaching the tabs to the anode foil
- Minor mechanical damage caused during winding

A sample from each batch is taken by the quality department after completion of the production process. This sample size is controlled by the use of recognized sampling tables defined in BS 6001.

The following tests are applied and may be varied at the request of the customer. In this case the batch, or special procedure, will determine the course of action.

Electrical:

- Leakage current
- Capacitance
- ESR
- Impedance
- Tan Delta

Mechanical/Visual:

- Overall dimensions
- Torque test of mounting stud
- Print detail
- Box labels
- Packaging, including packed quantity

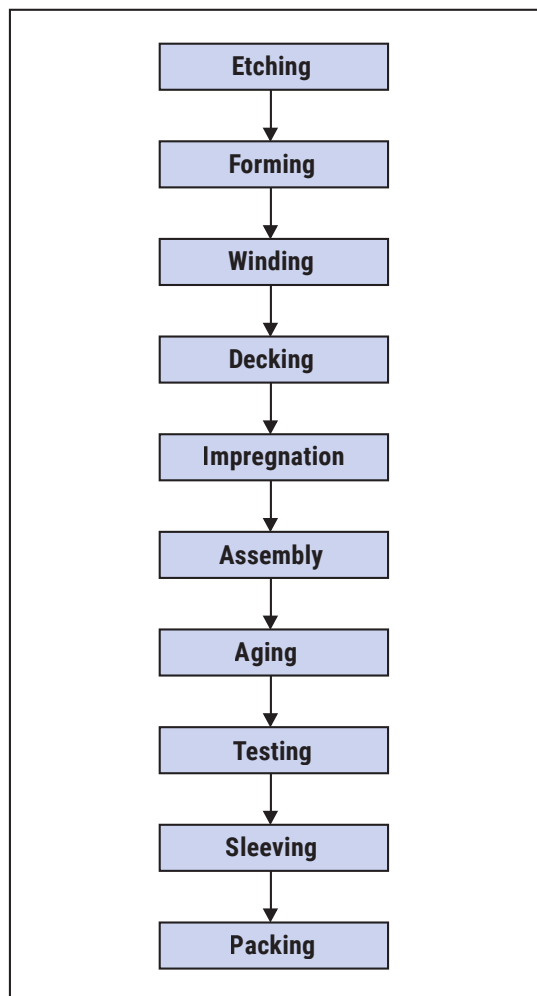
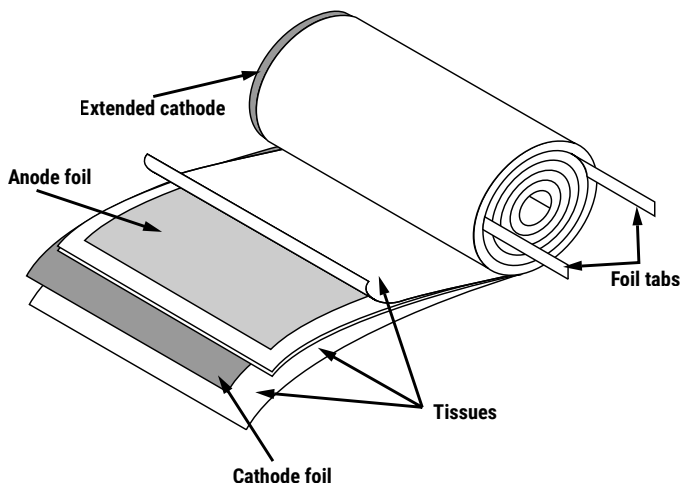

KEMET Electronics Corporation Sales Offices

For a complete list of our global sales offices, please visit www.kemet.com/sales.

Disclaimer

All product specifications, statements, information and data (collectively, the "Information") in this datasheet are subject to change. The customer is responsible for checking and verifying the extent to which the Information contained in this publication is applicable to an order at the time the order is placed. All Information given herein is believed to be accurate and reliable, but it is presented without guarantee, warranty, or responsibility of any kind, expressed or implied.

Statements of suitability for certain applications are based on KEMET Electronics Corporation's ("KEMET") knowledge of typical operating conditions for such applications, but are not intended to constitute – and KEMET specifically disclaims – any warranty concerning suitability for a specific customer application or use. The Information is intended for use only by customers who have the requisite experience and capability to determine the correct products for their application. Any technical advice inferred from this Information or otherwise provided by KEMET with reference to the use of KEMET's products is given gratis, and KEMET assumes no obligation or liability for the advice given or results obtained.

Although KEMET designs and manufactures its products to the most stringent quality and safety standards, given the current state of the art, isolated component failures may still occur. Accordingly, customer applications which require a high degree of reliability or safety should employ suitable designs or other safeguards (such as installation of protective circuitry or redundancies) in order to ensure that the failure of an electrical component does not result in a risk of personal injury or property damage.

Although all product-related warnings, cautions and notes must be observed, the customer should not assume that all safety measures are indicated or that other measures may not be required.

KEMET is a registered trademark of KEMET Electronics Corporation.



Компания «ЭлектроПласт» предлагает заключение долгосрочных отношений при поставках импортных электронных компонентов на взаимовыгодных условиях!

Наши преимущества:

- Оперативные поставки широкого спектра электронных компонентов отечественного и импортного производства напрямую от производителей и с крупнейших мировых складов;
- Поставка более 17-ти миллионов наименований электронных компонентов;
- Поставка сложных, дефицитных, либо снятых с производства позиций;
- Оперативные сроки поставки под заказ (от 5 рабочих дней);
- Экспресс доставка в любую точку России;
- Техническая поддержка проекта, помощь в подборе аналогов, поставка прототипов;
- Система менеджмента качества сертифицирована по Международному стандарту ISO 9001;
- Лицензия ФСБ на осуществление работ с использованием сведений, составляющих государственную тайну;
- Поставка специализированных компонентов (Xilinx, Altera, Analog Devices, Intersil, Interpoint, Microsemi, Aeroflex, Peregrine, Syfer, Eurofarad, Texas Instrument, Miteq, Cobham, E2V, MA-COM, Hittite, Mini-Circuits, General Dynamics и др.);

Помимо этого, одним из направлений компании «ЭлектроПласт» является направление «Источники питания». Мы предлагаем Вам помощь Конструкторского отдела:

- Подбор оптимального решения, техническое обоснование при выборе компонента;
- Подбор аналогов;
- Консультации по применению компонента;
- Поставка образцов и прототипов;
- Техническая поддержка проекта;
- Защита от снятия компонента с производства.



Как с нами связаться

Телефон: 8 (812) 309 58 32 (многоканальный)

Факс: 8 (812) 320-02-42

Электронная почта: org@eplast1.ru

Адрес: 198099, г. Санкт-Петербург, ул. Калинина, дом 2, корпус 4, литера А.