

## HEXFRED® Ultrafast Soft Recovery Diode, 220 A



SOT-227

**FEATURES**

- Fast recovery time characteristic
- Electrically isolated base plate
- Large creepage distance between terminal
- Simplified mechanical designs, rapid assembly
- Designed and qualified for industrial level
- UL approved file E78996 
- Material categorization: For definitions of compliance please see [www.vishay.com/doc?99912](http://www.vishay.com/doc?99912)

**RoHS  
COMPLIANT**

PRODUCT SUMMARY	
$V_R$	1200 V
$V_F$ (typical)	2.68 V
$t_{rr}$ (typical)	58 ns
$I_{F(AV)}$ per module at $T_C$	220 A at 38 °C
Package	SOT-227

**DESCRIPTION/APPLICATIONS**

The dual diode series configuration (VS-HFA220FA120) is used for output rectification or freewheeling/clamping operation and high voltage application.

The semiconductor in the SOT-227 package is isolated from the copper base plate, allowing for common heatsinks and compact assemblies to be built.

These modules are intended for general applications such as HV power supplies, electronic welders, motor control and inverters.

ABSOLUTE MAXIMUM RATINGS				
PARAMETER	SYMBOL	TEST CONDITIONS	MAX.	UNITS
Cathode to anode voltage	$V_R$		1200	V
Continuous forward current <sup>(1)</sup>	$I_F$	$T_C = 68\text{ °C}$	110	A
Single pulse forward current	$I_{FSM}$	$T_J = 25\text{ °C}$	700	
Maximum power dissipation per leg	$P_D$	$T_C = 25\text{ °C}$	500	W
		$T_C = 100\text{ °C}$	400	
RMS isolation voltage	$V_{ISOL}$	Any terminal to case, $t = 1$ minute	2500	V
Operating junction and storage temperature range	$T_J, T_{Stg}$		- 55 to 150	°C

ELECTRICAL SPECIFICATIONS ( $T_J = 25\text{ °C}$ unless otherwise specified)						
PARAMETER	SYMBOL	TEST CONDITIONS	MIN.	TYP.	MAX.	UNITS
Cathode to anode breakdown voltage	$V_{BR}$	$I_R = 100\text{ }\mu\text{A}$	1200	-	-	V
Forward voltage	$V_{FM}$	$I_F = 100\text{ A}$	-	2.68	3.60	
		$I_F = 200\text{ A}$	-	3.41	4.70	
		$I_F = 100\text{ A}, T_J = 150\text{ °C}$	-	2.62	2.89	
		$I_F = 200\text{ A}, T_J = 150\text{ °C}$	-	3.59	3.89	
Reverse leakage current	$I_{RM}$	$V_R = V_R$ rated	-	10	75	$\mu\text{A}$
		$T_J = 125\text{ °C}, V_R = V_R$ rated	-	2	-	mA
		$T_J = 150\text{ °C}, V_R = V_R$ rated	-	6	15	

**Note**

<sup>(1)</sup> Maximum continuous forward current must be limited at 100 A to do not exceed the maximum temperature of power terminals.



<b>DYNAMIC RECOVERY CHARACTERISTICS</b> ( $T_J = 25\text{ }^\circ\text{C}$ unless otherwise specified)						
PARAMETER	SYMBOL	TEST CONDITIONS	MIN.	TYP.	MAX.	UNITS
Reverse recovery time	$t_{rr}$	$I_F = 1\text{ A}$ ; $di_F/dt = -200\text{ A}/\mu\text{s}$ ; $V_R = 30\text{ V}$	-	58	-	ns
		$T_J = 25\text{ }^\circ\text{C}$	-	157	-	
		$T_J = 125\text{ }^\circ\text{C}$	-	255	-	
Peak recovery current	$I_{RRM}$	$T_J = 25\text{ }^\circ\text{C}$	-	15	-	A
		$T_J = 125\text{ }^\circ\text{C}$	-	22.5	-	
Reverse recovery charge	$Q_{rr}$	$T_J = 25\text{ }^\circ\text{C}$	-	1150	-	nC
		$T_J = 125\text{ }^\circ\text{C}$	-	2850	-	
Junction capacitance	$C_T$	$V_R = 1200\text{ V}$	-	53	-	pF

<b>THERMAL - MECHANICAL SPECIFICATIONS</b>						
PARAMETER	SYMBOL	TEST CONDITIONS	MIN.	TYP.	MAX.	UNITS
Junction to case, single leg conducting	$R_{thJC}$		-	-	0.25	$^\circ\text{C}/\text{W}$
Junction to case, both legs conducting			-	-	0.125	
Case to heatsink	$R_{thCS}$	Flat, greased surface	-	0.10	-	g
Weight			-	30	-	g
Mounting torque			-	-	1.3	Nm
Case style			SOT-227			

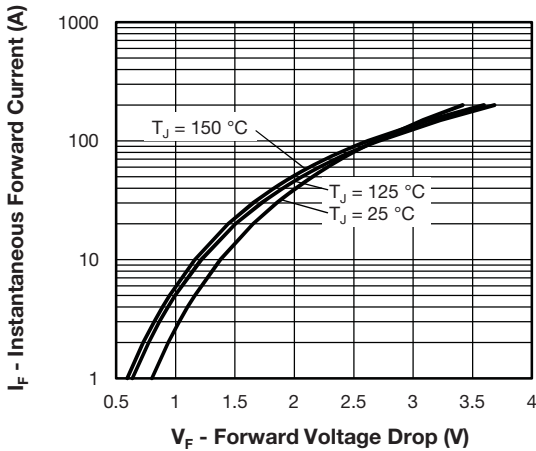

Fig. 1 - Typical Forward Voltage Drop Characteristics (Per Leg)

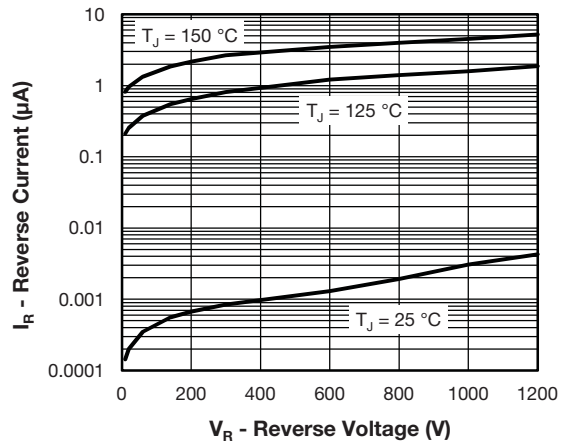

Fig. 2 - Typical Values of Reverse Current vs. Reverse Voltage

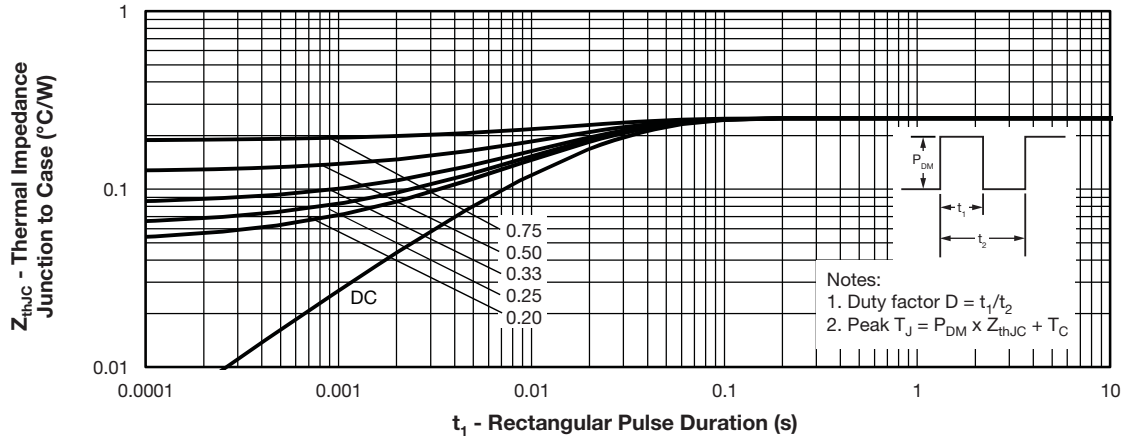

Fig. 3 - Maximum Thermal Impedance  $Z_{thJC}$  Characteristics (Per Leg)

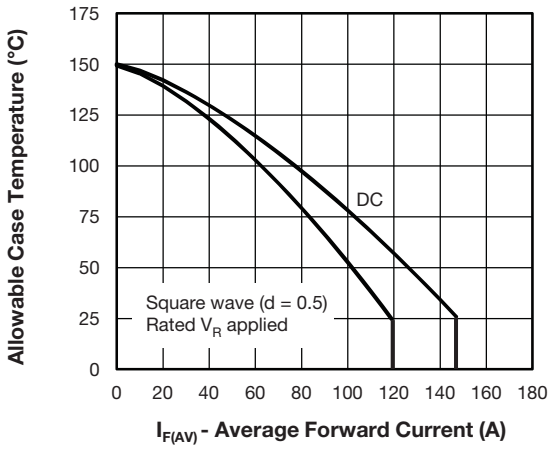

Fig. 4 - Maximum Allowable Case Temperature vs. Average Forward Current (Per Leg)

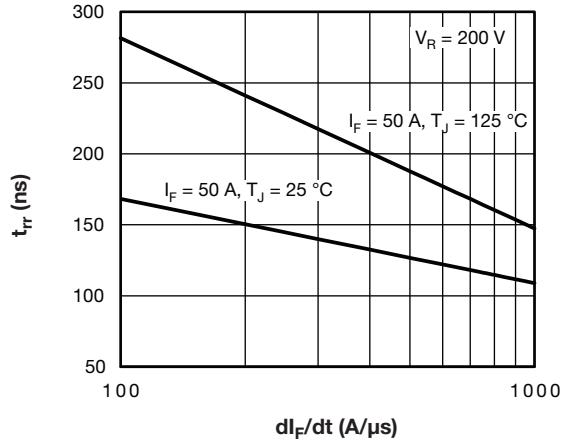

Fig. 6 - Typical Reverse Recovery Time vs.  $dI_F/dt$

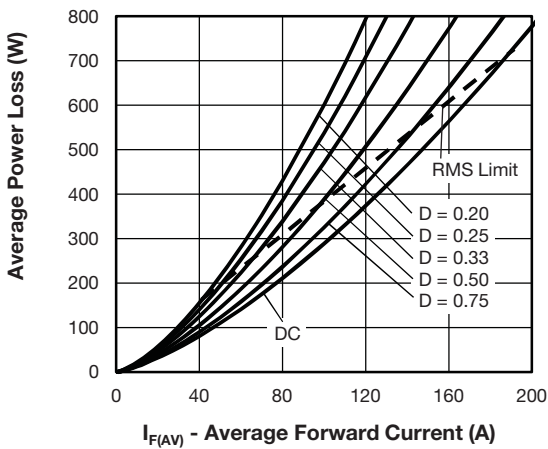

Fig. 5 - Forward Power Losses Characteristics (Per Leg)

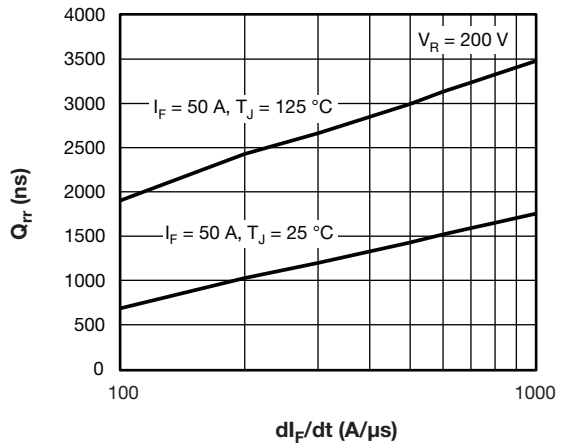

Fig. 7 - Typical Stored Charge vs.  $dI_F/dt$

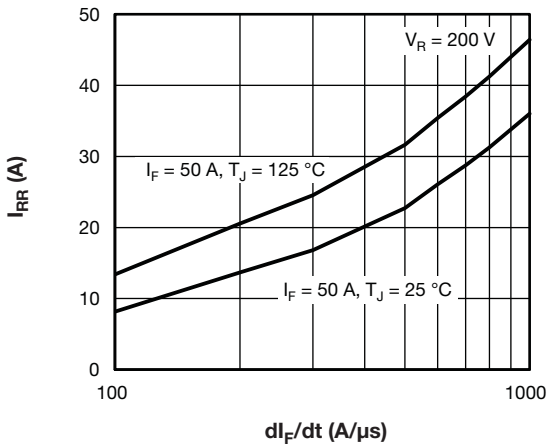

Fig. 8 - Typical Peak Recovery Current vs.  $di_F/dt$

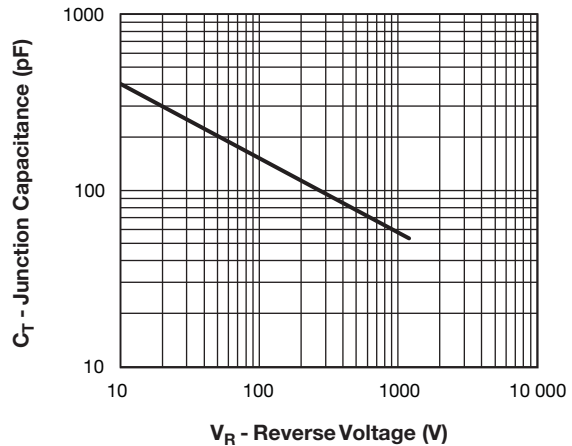

Fig. 9 - Typical Junction Capacitance vs. Reverse Voltage

**Note**

- (1) Formula used:  $T_C = T_J - (Pd + Pd_{REV}) \times R_{thJC}$ ;  
 $Pd$  = Forward power loss =  $I_{F(AV)} \times V_{FM}$  at  $(I_{F(AV)}/D)$  (see fig. 5);  
 $Pd_{REV}$  = Inverse power loss =  $V_{R1} \times I_R (1 - D)$ ;  $I_R$  at  $V_{R1}$  = Rated  $V_R$

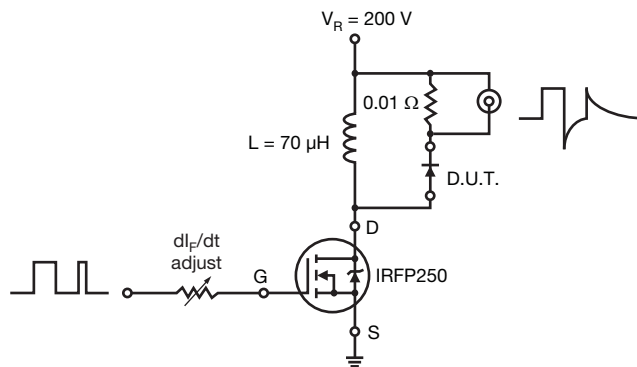
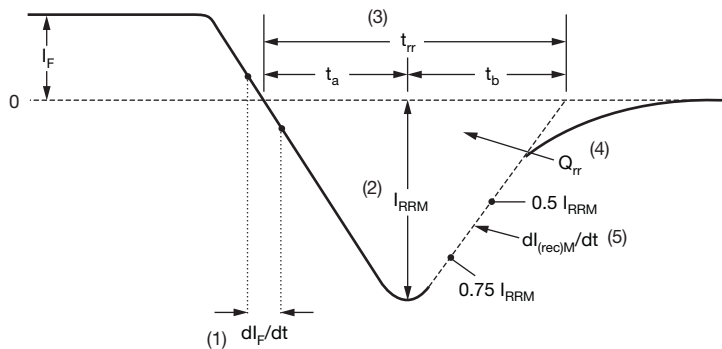

Fig. 10 - Reverse Recovery Parameter Test Circuit



- (1)  $di_F/dt$  - rate of change of current through zero crossing  
 (2)  $I_{RRM}$  - peak reverse recovery current  
 (3)  $t_{tr}$  - reverse recovery time measured from zero crossing point of negative going  $I_F$  to point where a line passing through  $0.75 I_{RRM}$  and  $0.50 I_{RRM}$  extrapolated to zero current.  
 (4)  $Q_{rr}$  - area under curve defined by  $t_{tr}$  and  $I_{RRM}$   

$$Q_{rr} = \frac{t_{tr} \times I_{RRM}}{2}$$
  
 (5)  $di_{(rec)M}/dt$  - peak rate of change of current during  $t_b$  portion of  $t_{tr}$

Fig. 11 - Reverse Recovery Waveform and Definitions

## ORDERING INFORMATION TABLE

Device code	VS-	HF	A	220	F	A	120
	①	②	③	④	⑤	⑥	⑦

- 1** - Vishay Semiconductors product
- 2** - HEXFRED<sup>®</sup> family
- 3** - Process designator (A = Electron irradiated)
- 4** - Average current (220 = 220 A)
- 5** - Circuit configuration (2 separate diodes, parallel pin-out)
- 6** - Package indicator (SOT-227 standard insulated base)
- 7** - Voltage rating (120 = 1200 V)

CIRCUIT CONFIGURATION		
CIRCUIT	CIRCUIT CONFIGURATION CODE	CIRCUIT DRAWING
2 separate diodes, parallel pin-out	F	<p>Lead Assignment</p>



## Disclaimer

ALL PRODUCT, PRODUCT SPECIFICATIONS AND DATA ARE SUBJECT TO CHANGE WITHOUT NOTICE TO IMPROVE RELIABILITY, FUNCTION OR DESIGN OR OTHERWISE.

Vishay Intertechnology, Inc., its affiliates, agents, and employees, and all persons acting on its or their behalf (collectively, "Vishay"), disclaim any and all liability for any errors, inaccuracies or incompleteness contained in any datasheet or in any other disclosure relating to any product.

Vishay makes no warranty, representation or guarantee regarding the suitability of the products for any particular purpose or the continuing production of any product. To the maximum extent permitted by applicable law, Vishay disclaims (i) any and all liability arising out of the application or use of any product, (ii) any and all liability, including without limitation special, consequential or incidental damages, and (iii) any and all implied warranties, including warranties of fitness for particular purpose, non-infringement and merchantability.

Statements regarding the suitability of products for certain types of applications are based on Vishay's knowledge of typical requirements that are often placed on Vishay products in generic applications. Such statements are not binding statements about the suitability of products for a particular application. It is the customer's responsibility to validate that a particular product with the properties described in the product specification is suitable for use in a particular application. Parameters provided in datasheets and/or specifications may vary in different applications and performance may vary over time. All operating parameters, including typical parameters, must be validated for each customer application by the customer's technical experts. Product specifications do not expand or otherwise modify Vishay's terms and conditions of purchase, including but not limited to the warranty expressed therein.

Except as expressly indicated in writing, Vishay products are not designed for use in medical, life-saving, or life-sustaining applications or for any other application in which the failure of the Vishay product could result in personal injury or death. Customers using or selling Vishay products not expressly indicated for use in such applications do so at their own risk. Please contact authorized Vishay personnel to obtain written terms and conditions regarding products designed for such applications.

No license, express or implied, by estoppel or otherwise, to any intellectual property rights is granted by this document or by any conduct of Vishay. Product names and markings noted herein may be trademarks of their respective owners.

## Material Category Policy

**Vishay Intertechnology, Inc. hereby certifies that all its products that are identified as RoHS-Compliant fulfill the definitions and restrictions defined under Directive 2011/65/EU of The European Parliament and of the Council of June 8, 2011 on the restriction of the use of certain hazardous substances in electrical and electronic equipment (EEE) - recast, unless otherwise specified as non-compliant.**

**Please note that some Vishay documentation may still make reference to RoHS Directive 2002/95/EC. We confirm that all the products identified as being compliant to Directive 2002/95/EC conform to Directive 2011/65/EU.**

**Vishay Intertechnology, Inc. hereby certifies that all its products that are identified as Halogen-Free follow Halogen-Free requirements as per JEDEC JS709A standards. Please note that some Vishay documentation may still make reference to the IEC 61249-2-21 definition. We confirm that all the products identified as being compliant to IEC 61249-2-21 conform to JEDEC JS709A standards.**



Компания «ЭлектроПласт» предлагает заключение долгосрочных отношений при поставках импортных электронных компонентов на взаимовыгодных условиях!

Наши преимущества:

- Оперативные поставки широкого спектра электронных компонентов отечественного и импортного производства напрямую от производителей и с крупнейших мировых складов;
- Поставка более 17-ти миллионов наименований электронных компонентов;
- Поставка сложных, дефицитных, либо снятых с производства позиций;
- Оперативные сроки поставки под заказ (от 5 рабочих дней);
- Экспресс доставка в любую точку России;
- Техническая поддержка проекта, помощь в подборе аналогов, поставка прототипов;
- Система менеджмента качества сертифицирована по Международному стандарту ISO 9001;
- Лицензия ФСБ на осуществление работ с использованием сведений, составляющих государственную тайну;
- Поставка специализированных компонентов (Xilinx, Altera, Analog Devices, Intersil, Interpoint, Microsemi, Aeroflex, Peregrine, Syfer, Eurofarad, Texas Instrument, Miteq, Cobham, E2V, MA-COM, Hittite, Mini-Circuits, General Dynamics и др.);

Помимо этого, одним из направлений компании «ЭлектроПласт» является направление «Источники питания». Мы предлагаем Вам помощь Конструкторского отдела:

- Подбор оптимального решения, техническое обоснование при выборе компонента;
- Подбор аналогов;
- Консультации по применению компонента;
- Поставка образцов и прототипов;
- Техническая поддержка проекта;
- Защита от снятия компонента с производства.



#### Как с нами связаться

**Телефон:** 8 (812) 309 58 32 (многоканальный)

**Факс:** 8 (812) 320-02-42

**Электронная почта:** [org@eplast1.ru](mailto:org@eplast1.ru)

**Адрес:** 198099, г. Санкт-Петербург, ул. Калинина, дом 2, корпус 4, литера А.