

Operational Amplifiers



Low Noise Operational Amplifiers

BA4558xxx, BA4558Rxxx

●General Description

Normal BA4558 and high-reliability BA4558R integrate two independent Op-Amps on a single chip Especially, this series is suitable for any audio applications due to low noise and low distortion characteristics and are usable for other many applications by wide operating supply voltage range. BA4558R is high-reliability products with extended operating temperature range and high ESD tolerance.

●Features

- High voltage gain, low noise, low distortion
- Wide operating supply voltage
- Internal ESD protection
- Wide operating temperature Range

●Packages

	W(Typ.) x D(Typ.) x H(Max.)
MSOP8	2.90mm x 4.00mm x 0.90mm
SSOP-B8	3.00mm x 6.40mm x 1.35mm
SOP8	5.00mm x 6.20mm x 1.71mm
TSSOP-B8	3.00mm x 6.40mm x 1.20mm
SOP-J8	4.90mm x 6.00mm x 1.65mm

●Key Specification

- Wide Operating Supply Voltage
(split supply): ±4.0V to ±15V
- Wide Temperature Range: BA4558: -40°C to +85°C
BA4558R: -40°C to +105°C
- High Slew Rate: 1V/μs(Typ.)
- Total Harmonic Distortion : 0.005%(Typ.)
- Input Referred Noise Voltage : 12 nV/√Hz (Typ.)

●Selection Guide

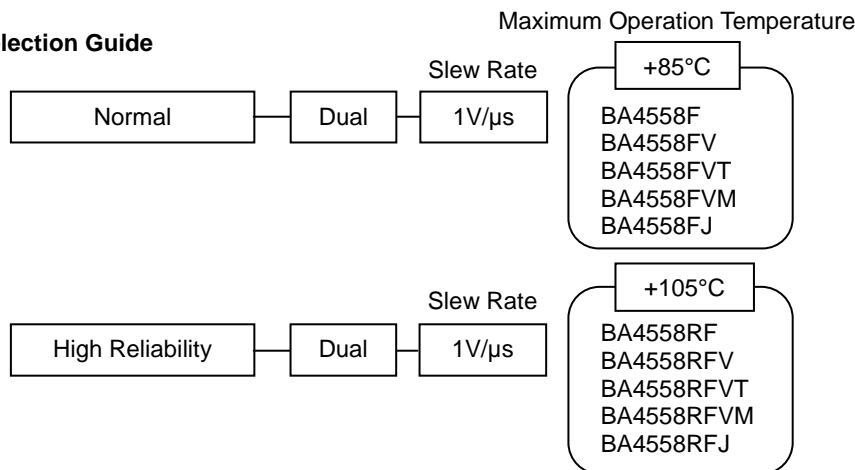

●Block Diagram

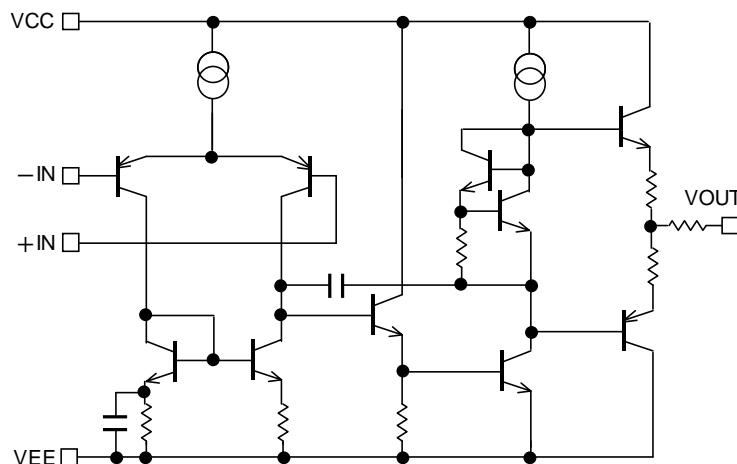
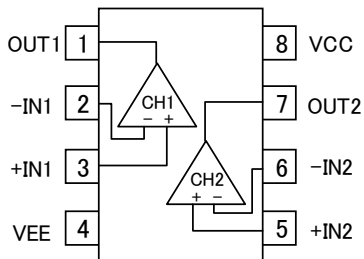

Fig. 1 Simplified schematic

○Product structure : Silicon monolithic integrated circuit ○This product is not designed protection against radioactive rays.

●Pin Configuration(TOP VIEW)



SOP8	SSOP-B8	TSSOP-B8	MSOP8	SOP-J8
BA4558F BA4558RF	BA4558FV BA4558RFV	BA4558FVT BA4558RFVT	BA4558FVM BA4558RFVM	BA4558FJ BA4558RFJ

Package				
SOP8	SSOP-B8	TSSOP-B8	MSOP8	SOP-J8
BA4558F BA4558RF	BA4558FV BA4558RFV	BA4558FVT BA4558RFVT	BA4558FVM BA4558RFVM	BA4558FJ BA4558RFJ

●Ordering Information

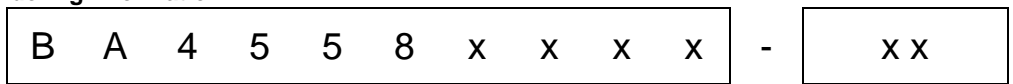

Part Number BA4558xxx BA4558Rxxx	Package F: SOP8 FV: SSOP-B8 FJ: SOP-J8 FVT: TSSOP-B8 FVM: MSOP8	Packaging and forming specification E2: Embossed tape and reel (SOP8/SSOP-B8/TSSOP-B8/SOP-J8) TR: Embossed tape and reel (MSOP8)
--	--	--

●Line-up

Topr	Operating Supply Voltage (split supply)	Supply Current (Typ.)	Slew Rate (Typ.)	Package		Orderable Part Number
-40°C to +85°C	±4.0V to ±15.0V	3mA	1V/μs	SOP8	Reel of 2500	BA4558F-E2
				SSOP-B8	Reel of 2500	BA4558FV-E2
				TSSOP-B8	Reel of 3000	BA4558FVT-E2
				MSOP8	Reel of 3000	BA4558FVM-TR
				SOP-J8J	Reel of 2500	BA4558FJ-E2
-40°C to +105°C				SOP8	Reel of 2500	BA4558RF-E2
				SSOP-B8	Reel of 2500	BA4558RFV-E2
				TSSOP-B8	Reel of 3000	BA4558RFVT-E2
				MSOP8	Reel of 3000	BA4558RFVM-TR
				SOP-J8	Reel of 2500	BA4558RFJ-E2

● Absolute Maximum Ratings (Ta=25°C)

OBA4558, BA4558R

Parameter	Symbol	Ratings		Unit	
		BA4558	BA4558R		
Supply Voltage	VCC-VEE	+36		V	
Power dissipation	Pd	SOP8	552 ^{*1*5}	690 ^{*1*5}	mW
		SSOP-B8	500 ^{*2*5}	625 ^{*2*5}	
		TSSOP-B8	500 ^{*2*5}	625 ^{*2*5}	
		MSOP8	470 ^{*3*5}	587 ^{*3*5}	
		SOP-J8	540 ^{*4*5}	675 ^{*4*5}	
Differential Input Voltage ^{*5}	Vid	VCC-VEE	+36	V	
Input common-mode voltage range	Vicm	VEE to VCC	(VEE-0.3) to VEE+36	V	
Operating Supply Voltage	Vopr	+8 to +30 (±4 to ±15)		V	
Operating Temperature	Topr	-40 to +85	-40 to +105	°C	
Storage Temperature	Tstg	-55 to +125	-55 to +150	°C	
Maximum Junction Temperature	Tjmax	+125	+150	°C	

Note: Absolute maximum rating item indicates the condition which must not be exceeded.

Application of voltage in excess of absolute maximum rating or use out absolute maximum rated temperature environment may cause deterioration of characteristics.

*1 To use at temperature above Ta=25°C reduce 5.52mW.

*2 To use at temperature above Ta=25°C reduce 5mW.

*3 To use at temperature above Ta=25°C reduce 4.7mW.

*4 To use at temperature above Ta=25°C reduce 5.4mW.

*5 Mounted on a FR4 glass epoxy PCB(70mm×70mm×1.6mm).

*6 The voltage difference between inverting input and non-inverting input is the differential input voltage. Then input terminal voltage is set to more than VEE.

●Electrical Characteristics

OBA4558 (Unless otherwise specified VCC=+15V, VEE=-15V)

Parameter	Symbol	Temperature Range	Limits			Unit	Condition
			Min.	Typ.	Max.		
Input Offset Voltage ^{*7}	Vio	25°C	-	0.5	6	mV	VOUT=0V
Input Offset Current ^{*7}	Iio	25°C	-	5	200	nA	VOUT=0V
Input Bias Current ^{*8}	Ib	25°C	-	60	500	nA	VOUT=0V
Supply Current	ICC	25°C	-	3	6	mA	RL=∞, All Op-Amps, VIN+=0V
Maximum Output Voltage	VOM	25°C	±10	±13	-	V	RL ≥ 2kΩ
		25°C	±12	±14	-		RL ≥ 10kΩ
Large Signal Voltage Gain	AV	25°C	86	100	-	dB	RL ≥ 2kΩ, VOUT=±10V, Vicm=0V
Input Common-mode Voltage Range	Vicm	25°C	±12	±14	-	V	-
Common-mode Rejection Ratio	CMRR	25°C	70	90	-	dB	Ri ≤ 10kΩ
Power Supply Rejection Ratio	PSRR	25°C	76.3	90	-	dB	Ri ≤ 10kΩ
Slew Rate	SR	25°C	-	1	-	V/μs	AV=0dB, RL ≥ 2kΩ
Unity Gain Frequency	ft	25°C	-	2	-	MHz	RL=2kΩ
Total Harmonic Distortion	THD+N	25°C	-	0.005	-	%	AV=20dB, RL=10kΩ VIN=0.05Vrms, f=1kHz
Input Referred Noise Voltage	Vn	25°C	-	12	-	nV/√Hz	RS=100Ω, Vi=0V, f=1kHz
			-	1.8	-	μVrms	RS=100Ω, Vi=0V, DIN-AUDIO
Channel Separation	CS	25°C	-	105	-	dB	f=1kHz

*7 Absolute value

*8 Current direction: Since first input stage is composed with PNP transistor, input bias current flows out of IC.

OBA4558R (Unless otherwise specified VCC=+15V, VEE=-15V, Full range -40°C to +105°C)

Parameter	Symbol	Temperature Range	Limits			Unit	Condition
			Min.	Typ.	Max.		
Input Offset Voltage ^{*9}	Vio	25°C	-	0.5	6	mV	VOUT=0V
		Full range	-	-	7		
Input Offset Current ^{*9}	Iio	25°C	-	5	200	nA	VOUT=0V
		Full range	-	-	200		
Input Bias Current ^{*10}	Ib	25°C	-	60	500	nA	VOUT=0V
		Full range	-	-	800		
Supply Current	ICC	25°C	-	3	6	mA	RL=∞, All Op-Amps, VIN+=0V
		Full range	-	-	6.5		
Maximum Output Voltage	VOM	25°C	±10	±13	-	V	RL ≥ 2kΩ
		Full range	±10	-	-		RL ≥ 10kΩ
		25°C	±12	±14	-		
Large Signal Voltage Gain	AV	25°C	86	100	-	dB	RL ≥ 2kΩ, VOUT=±10V, Vicm=0V
		Full range	83	-	-		
Input Common-mode Voltage Range	Vicm	25°C	±12	±14	-	V	-
		Full range	±12	-	-		
Common-mode Rejection Ratio	CMRR	25°C	70	90	-	dB	Ri ≤ 10kΩ
Power Supply Rejection Ratio	PSRR	25°C	76.5	90	-	dB	Ri ≤ 10kΩ
Slew Rate	SR	25°C	-	1	-	V/μs	AV=0dB, RL=2kΩ CL=100pF
Unity Gain Frequency	ft	25°C	-	2	-	MHz	RL=2kΩ
Total Harmonic Distortion	THD+N	25°C	-	0.005	-	%	AV=20dB, RL=10kΩ VIN=0.05Vrms, f=1kHz
Input Referred Noise Voltage	Vn	25°C	-	12	-	nV/√Hz	RS=100Ω, Vi=0V, f=1kHz
			-	1.8	-	μVrms	RS=100Ω, Vi=0V, DIN-AUDIO
Channel Separation	CS	25°C	-	105	-	dB	R1=100Ω, f=1kHz

*9 Absolute value

*10 Current direction: Since first input stage is composed with PNP transistor, input bias current flows out of IC.

Description of electrical characteristics

Described here are the terms of electric characteristics used in this datasheet. Items and symbols used are also shown. Note that item name and symbol and their meaning may differ from those on another manufacture's document or general document.

1. Absolute maximum ratings

Absolute maximum rating item indicates the condition which must not be exceeded. Application of voltage in excess of absolute maximum rating or use out of absolute maximum rated temperature environment may cause deterioration of characteristics.

1.1 Power supply voltage (VCC-VEE)

Indicates the maximum voltage that can be applied between the positive power supply terminal and negative power supply terminal without deterioration or destruction of characteristics of internal circuit.

1.2 Differential input voltage (Vid)

Indicates the maximum voltage that can be applied between non-inverting terminal and inverting terminal without deterioration and destruction of characteristics of IC.

1.3 Input common-mode voltage range (Vicm)

Indicates the maximum voltage that can be applied to non-inverting terminal and inverting terminal without deterioration or destruction of characteristics. Input common-mode voltage range of the maximum ratings not assure normal operation of IC. When normal operation of IC is desired, the input common-mode voltage of characteristics item must be followed.

1.4 Power dissipation (Pd)

Indicates the power that can be consumed by specified mounted board at the ambient temperature 25°C(normal temperature). As for package product, Pd is determined by the temperature that can be permitted by IC chip in the package (maximum junction temperature)and thermal resistance of the package.

2. Electrical characteristics item**2.1 Input offset voltage (Vio)**

Indicates the voltage difference between non-inverting terminal and inverting terminal. It can be translated into the input voltage difference required for setting the output voltage at 0V.

2.2 Input offset current (Iio)

Indicates the difference of input bias current between non-inverting terminal and inverting terminal.

2.3 Input bias current (Ib)

Indicates the current that flows into or out of the input terminal. It is defined by the average of input bias current at non-inverting terminal and input bias current at inverting terminal.

2.4 Input common-mode voltage range (Vicm)

Indicates the input voltage range where IC operates normally.

2.5 Large signal voltage gain (AV)

Indicates the amplifying rate (gain) of output voltage against the voltage difference between non-inverting terminal and Inverting terminal. It is normally the amplifying rate (gain) with reference to DC voltage.
$$A_v = (\text{Output voltage fluctuation}) / (\text{Input offset fluctuation})$$

2.6 Circuit current (ICC)

Indicates the IC current that flows under specified conditions and no-load steady status.

2.7 Output saturation voltage (VOM)

Signifies the voltage range that can be output under specific output conditions.

2.8 Common-mode rejection ratio (CMRR)

Indicates the ratio of fluctuation of input offset voltage when in-phase input voltage is changed. It is normally the fluctuation of DC.

$$CMRR = (\text{Change of Input common-mode voltage}) / (\text{Input offset fluctuation})$$

2.9 Power supply rejection ratio (PSRR)

Indicates the ratio of fluctuation of input offset voltage when supply voltage is changed. It is normally the fluctuation of DC.

$$PSRR = (\text{Change of power supply voltage}) / (\text{Input offset fluctuation})$$

2.10 Channel Separation (CS)

Indicates the fluctuation of input offset voltage or that of output voltage with reference to the change of output voltage of driven channel.

2.11 Slew Rate (SR)

SR is a parameter that shows movement speed of operational amplifier. It indicates rate of variable output voltage as unit time.

2.12 Transition Frequency (ft)

Indicates a frequency where the voltage gain of operational amplifier is 1.

2.13 Total Harmonic Distortion (THD+N)

Indicates the fluctuation of input offset voltage or that of output voltage with reference to the change of output voltage of driven channel.

2.14 Input Referred Noise Voltage (Vn)

Indicates a noise voltage generated inside the operational amplifier equivalent by ideal voltage source connected in series with input terminal.

● Typical Performance Curves

○ BA4558

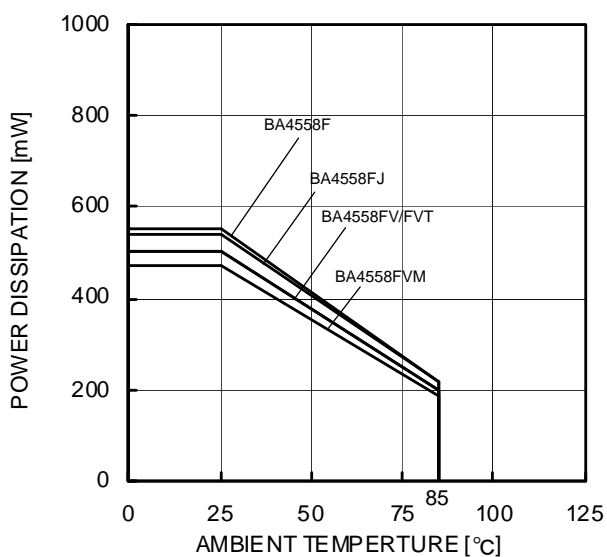

Fig.2 Derating Curve

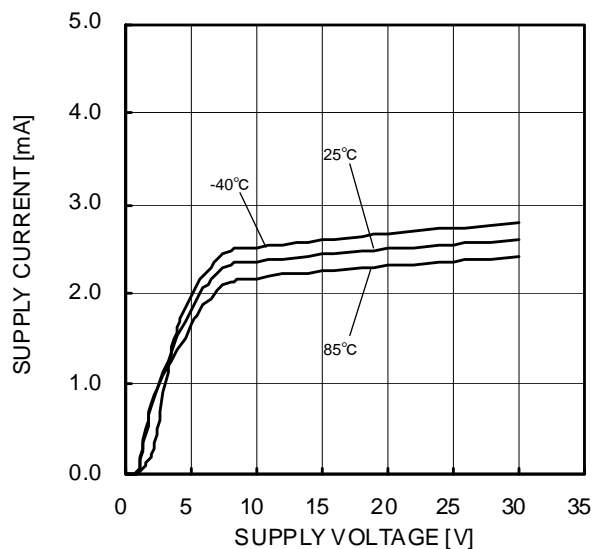

Fig.3 Supply Current - Supply Voltage

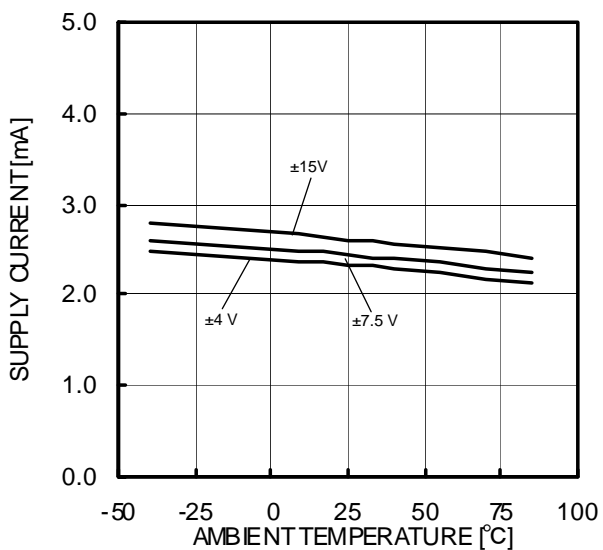

Fig.4 Supply Current - Ambient Temperature

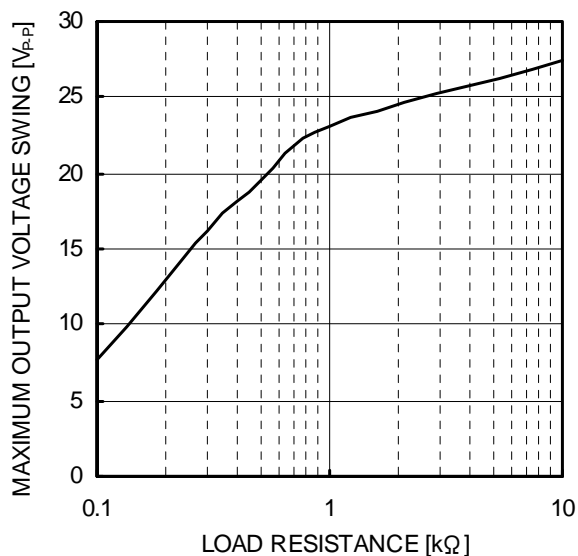

Fig.5 Maximum Output Voltage Swing - Load Resistance (VCC/VEE=+15V/-15V, Ta=25°C)

(*) The above data is measurement value of typical sample, it is not guaranteed.

○ BA4558

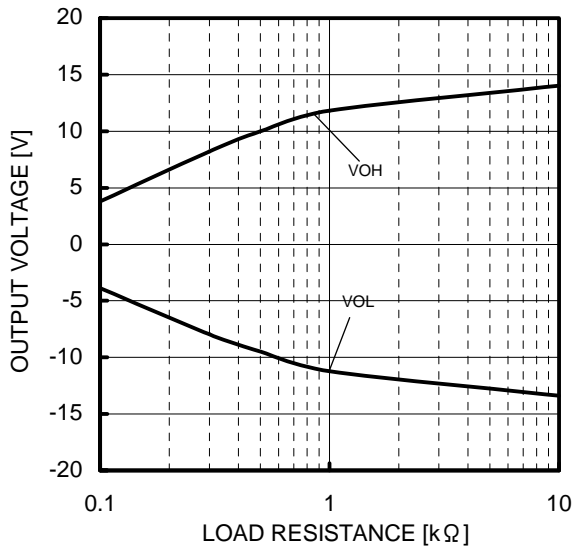

Fig.6
Maximum Output Voltage
- Load Resistance
(VCC/VEE=+15V/-15V, Ta=25°C)

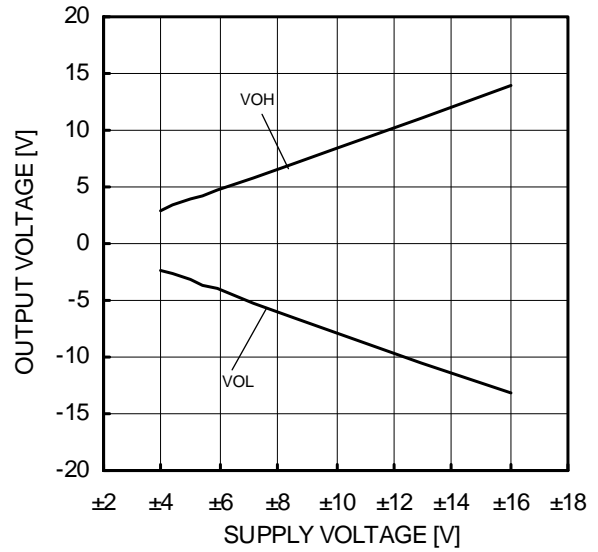

Fig.7
Maximum Output Voltage
- Supply Voltage
(RL=2kΩ, Ta=25°C)

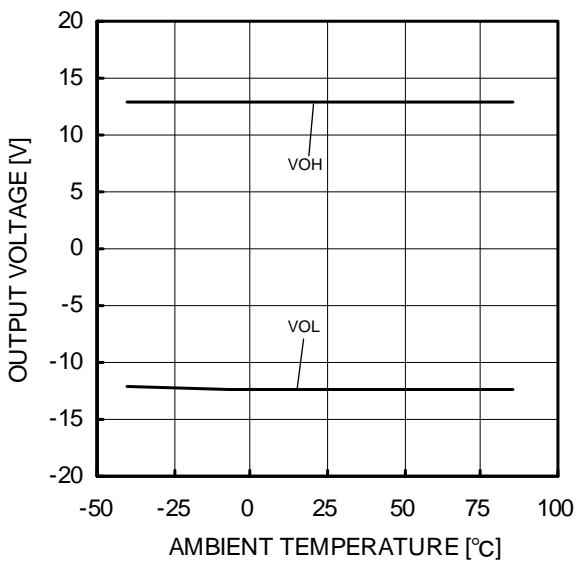

Fig.8
Maximum Output Voltage
- Ambient Temperature
(VCC/VEE=+15V/-15V, RL=2kΩ)

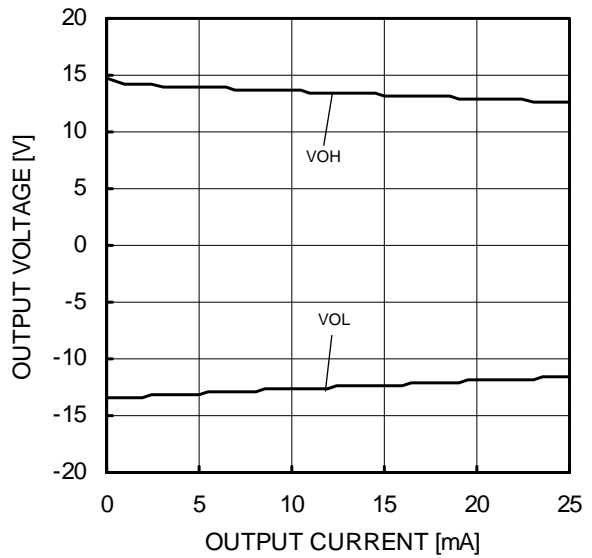

Fig.9
Maximum Output Voltage
- Output Current
(VCC/VEE=+15V/-15V, Ta=25°C)

(*) The above data is measurement value of typical sample, it is not guaranteed.

○ BA4558

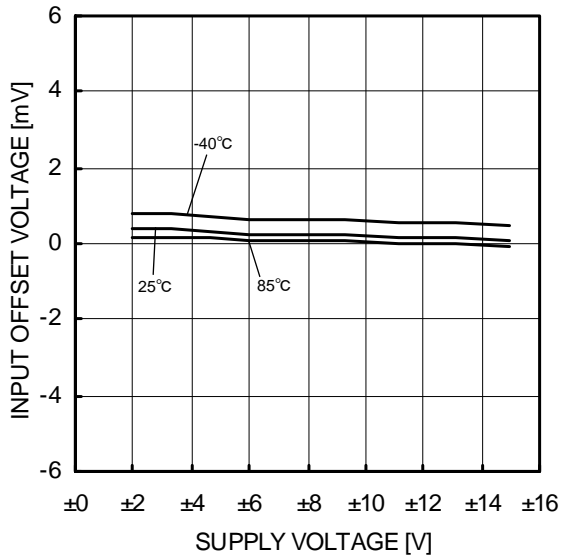

Fig.10
Input Offset Voltage - Supply Voltage
(Vicm=0V, Vout=0V)

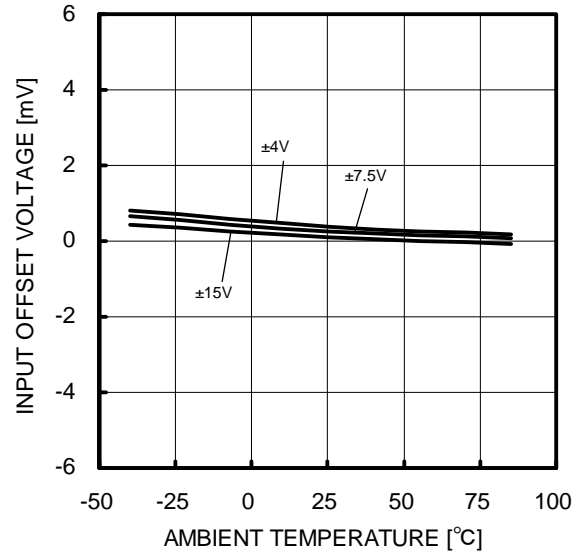

Fig.11
Input Offset Voltage - Ambient Temperature
(Vicm=0V, Vout=0V)

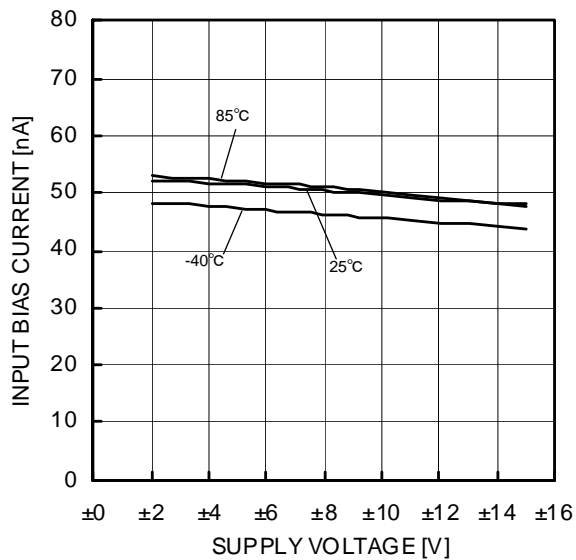

Fig.12
Input Bias Current - Supply Voltage
(Vicm=0V, Vout=0V)

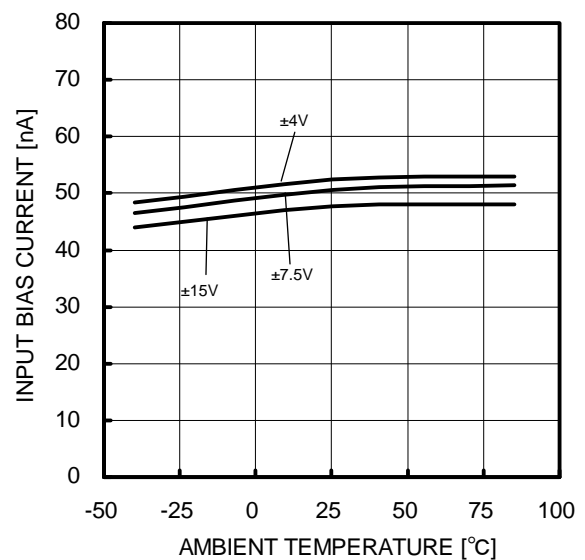

Fig.13
Input Bias Current - Ambient Temperature
(Vicm=0V, Vout=0V)

(*) The above data is measurement value of typical sample, it is not guaranteed.

○ BA4558

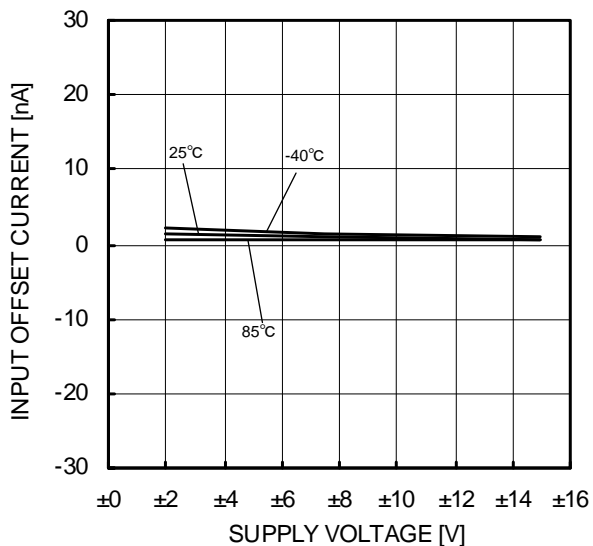

Fig.14
Input Offset Current - Supply Voltage
($V_{icm}=0V$, $V_{out}=0V$)

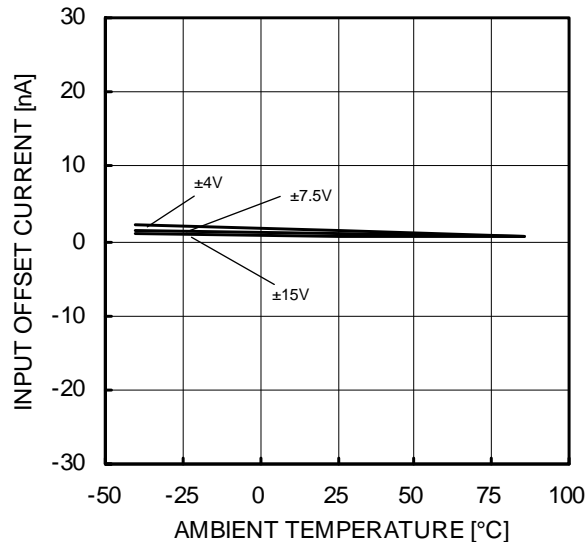

Fig.15
Input Offset Current - Ambient Temperature
($V_{icm}=0V$, $V_{out}=0V$)

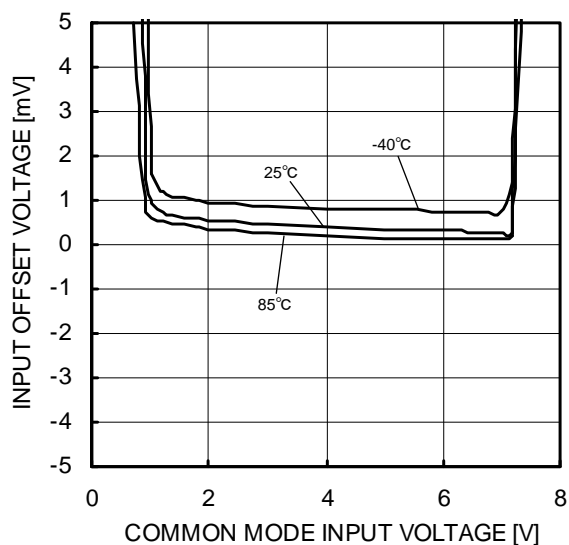

Fig.16
Input Offset Voltage - Common Mode Input Voltage
($V_{CC}=8V$, $V_{out}=4V$)

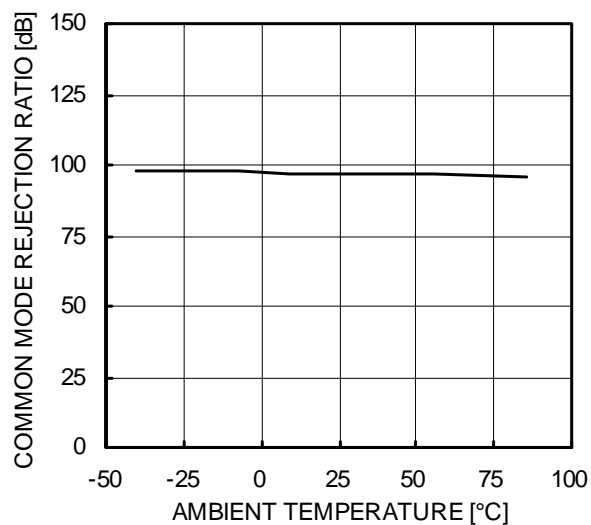

Fig.17
Common Mode Rejection Ratio - Ambient Temperature
($V_{CC}/V_{EE}=+15V/-15V$, $V_{icm}=-12V$ to $+12V$)

(*) The above data is measurement value of typical sample, it is not guaranteed.

○ BA4558

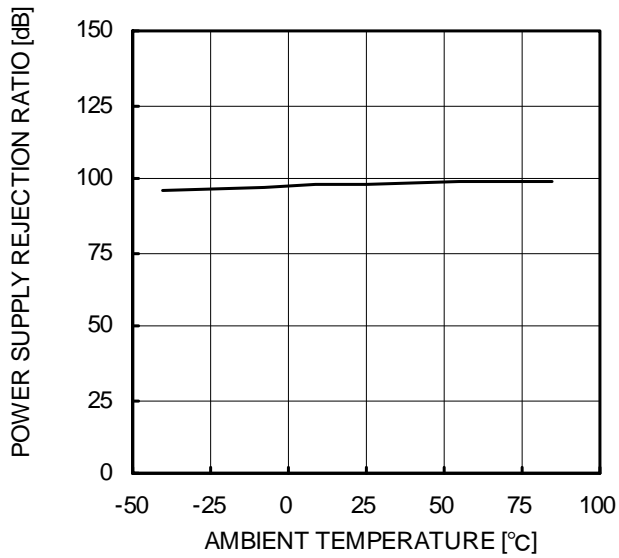

Fig.18
Power Supply Rejection Ratio
- Ambient Temperature
(VCC/VEE=+4V/-4V to +15V/-15V)

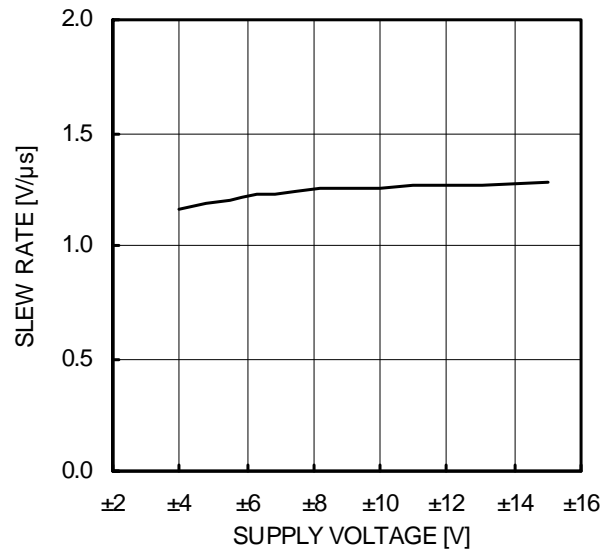

Fig.19
Slew Rate - Supply Voltage
(CL=100pF, RL=2kΩ, Ta=25°C)

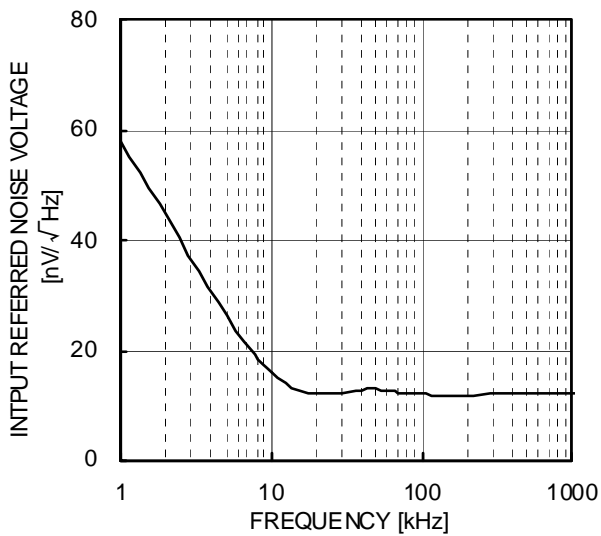

Fig.20
Equivalent Input Noise Voltage - Frequency
(VCC/VEE=+15V/-15V, RS=100Ω, Ta=25°C)

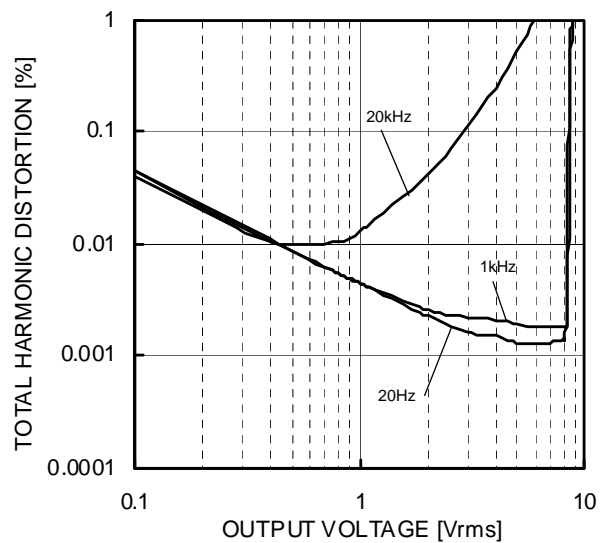

Fig.21
Total Harmonic Distortion -Output Voltage
RL=2kΩ, 80kHz-LPF, Ta=25°C)

(*) The above data is measurement value of typical sample, it is not guaranteed.

○ BA4558

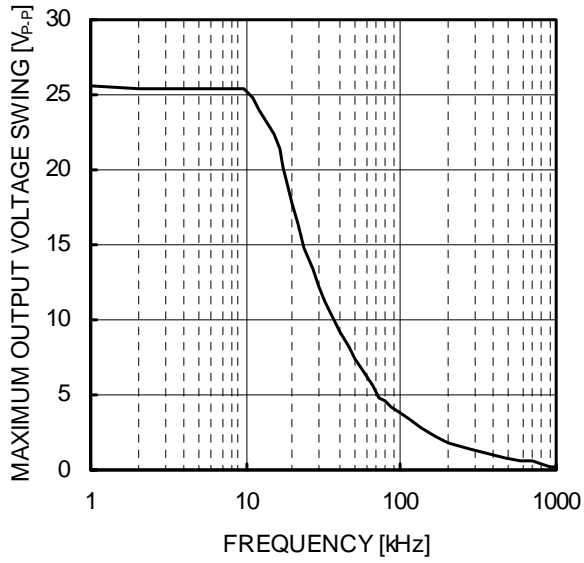

Fig.22
Maximum Output Voltage Swing - Frequency
(VCC/VEE=+15V/-15V, RL=2kΩ, Ta=25°C)

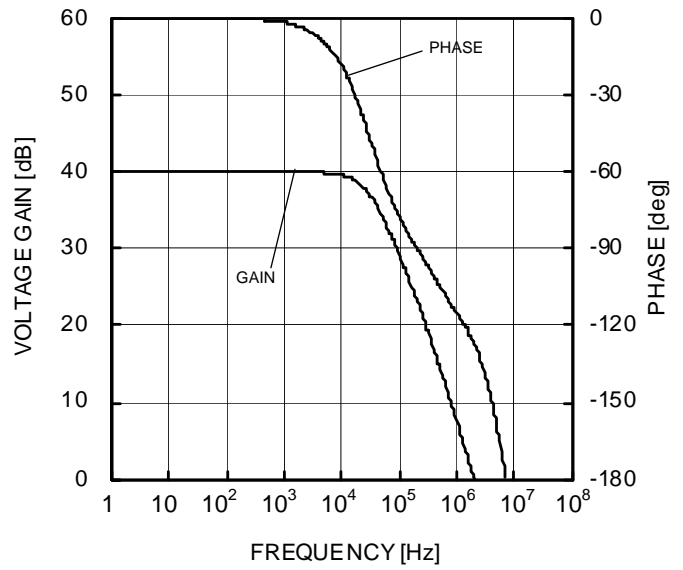

Fig.23
Voltage Gain - Frequency
(VCC/VEE=+15V/-15V, AV=40dB, RL=2kΩ, Ta=25°C)

(*) The above data is measurement value of typical sample, it is not guaranteed.

○ BA4558R

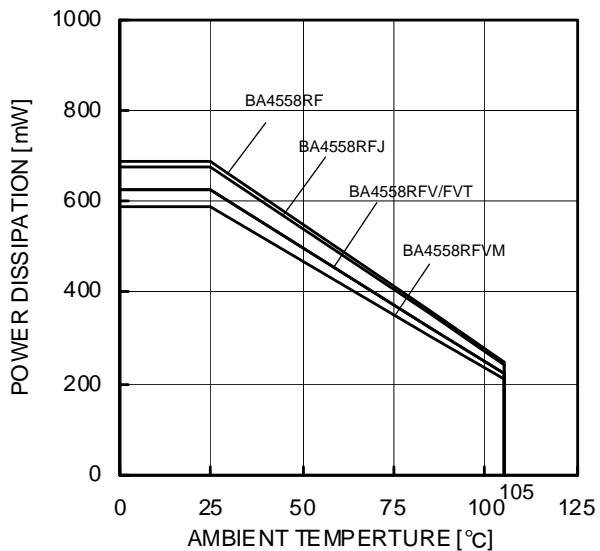

Fig.24
Derating Curve

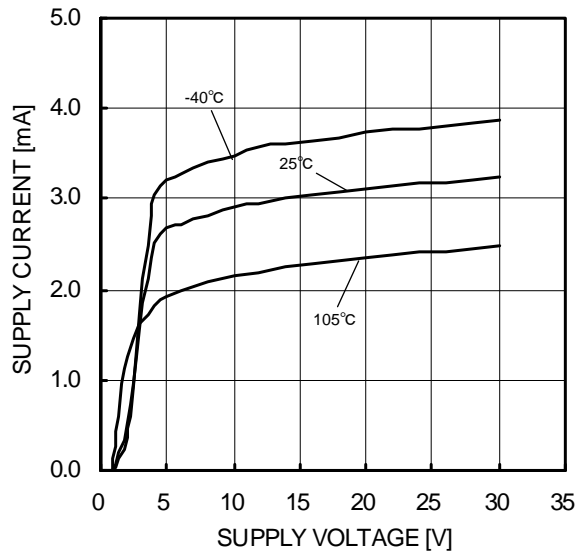

Fig.25
Supply Current - Supply Voltage

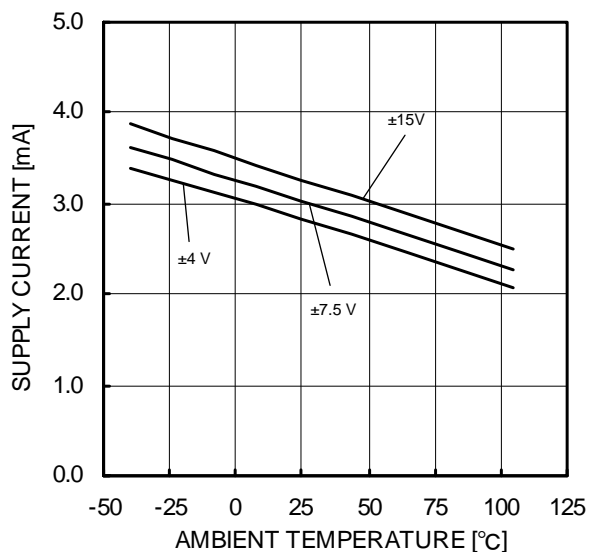

Fig.26
Supply Current - Ambient Temperature

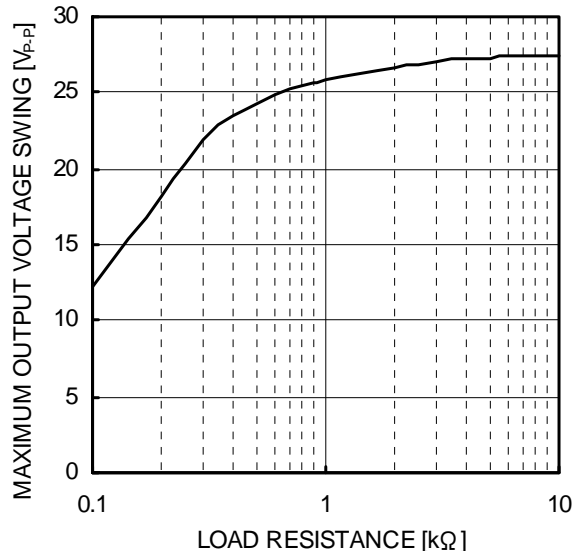

Fig.27
Maximum Output Voltage Swing
- Load Resistance
(VCC/VEE=+15V/-15V, Ta=25°C)

(*) The above data is measurement value of typical sample, it is not guaranteed.

○ BA4558R

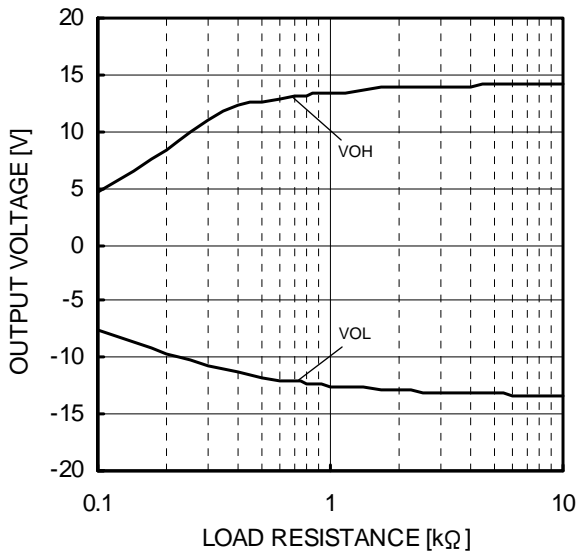

Fig.28
Maximum Output Voltage
- Load Resistance
(VCC/VEE=+15V/-15V, Ta=25°C)

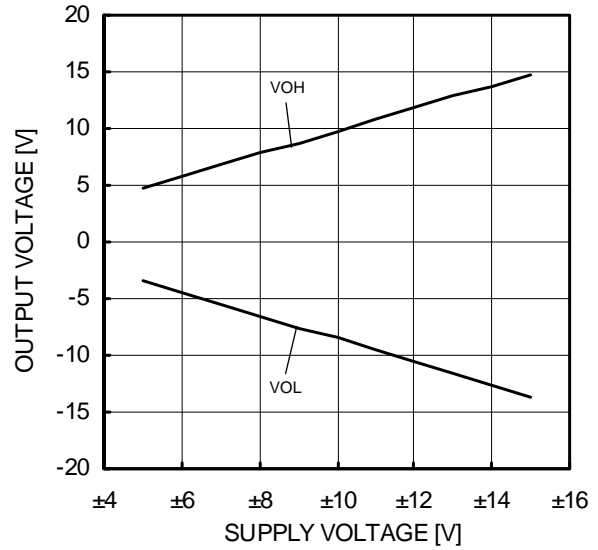

Fig.29
Maximum Output Voltage
- Supply Voltage
(RL=2kΩ, Ta=25°C)

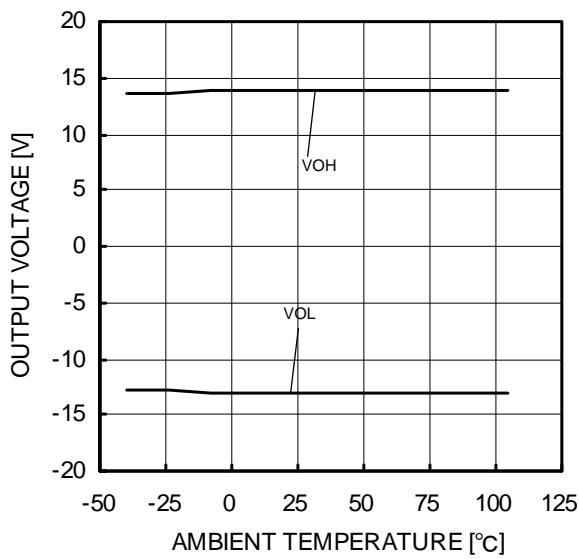

Fig.30
Maximum Output Voltage
- Ambient Temperature
(VCC/VEE=+15V/-15V, RL=2kΩ)

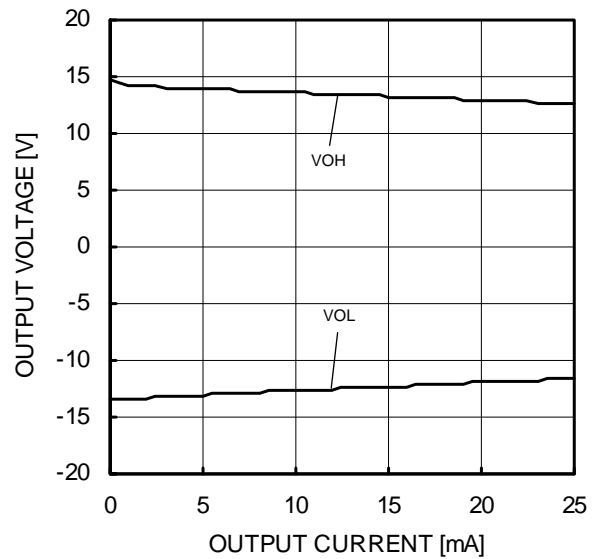

Fig.31
Maximum Output Voltage
- Output Current
(VCC/VEE=+15V/-15V, Ta=25°C)

(*) The above data is measurement value of typical sample, it is not guaranteed.

○ BA4558R

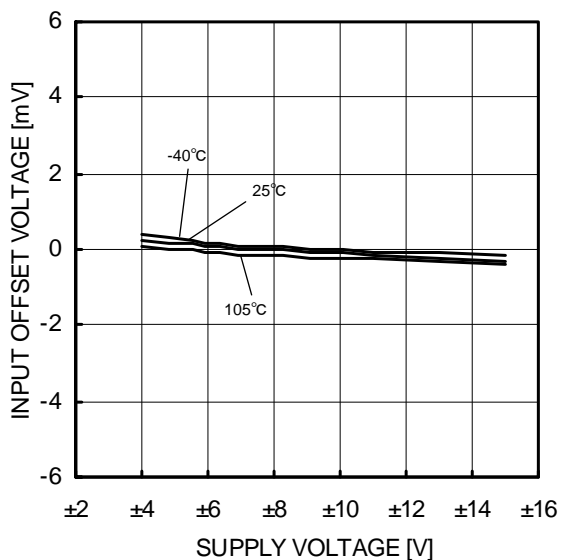

Fig.32
Input Offset Voltage - Supply Voltage
(Vicm=0V, Vout=0V)

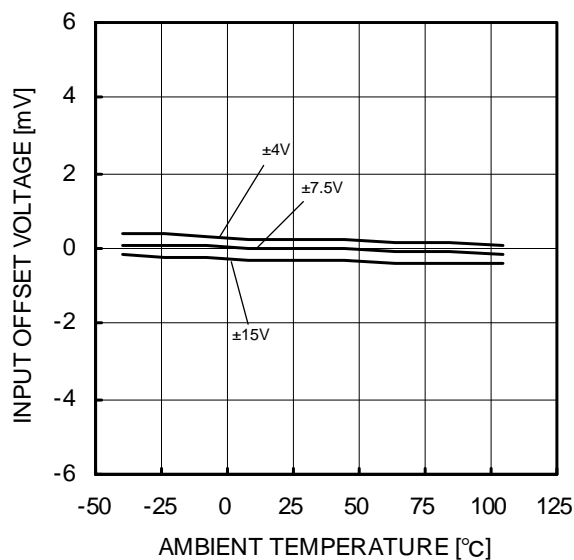

Fig.33
Input Offset Voltage - Ambient Temperature
(Vicm=0V, Vout=0V)

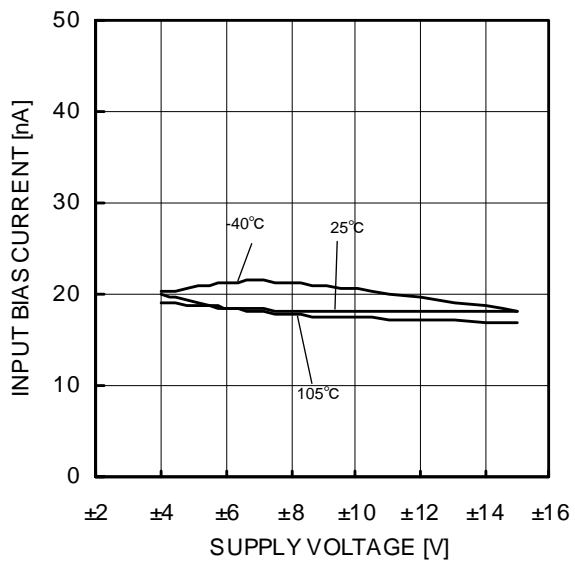

Fig.34
Input Bias Current - Supply Voltage
(Vicm=0V, Vout=0V)

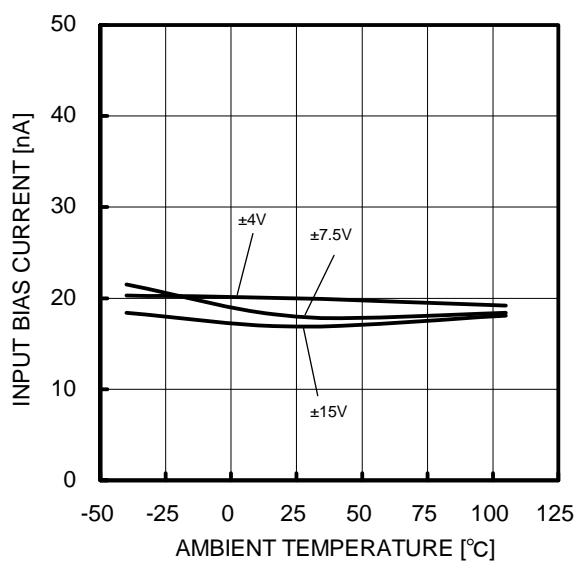

Fig.35
Input Bias Current - Ambient Temperature
(Vicm=0V, Vout=0V)

(*) The above data is measurement value of typical sample, it is not guaranteed.

○ BA4558R

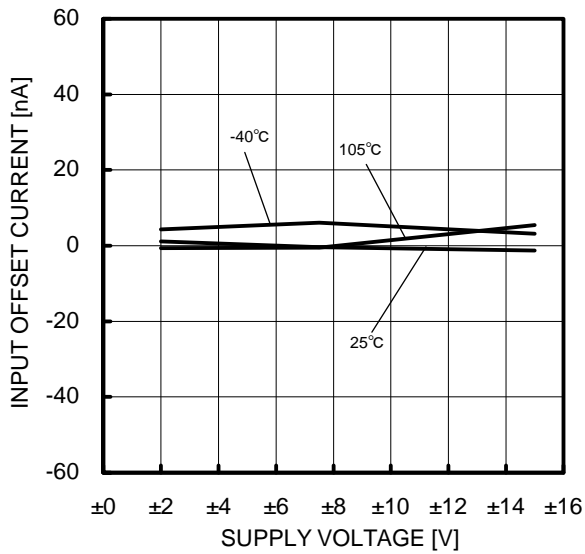

Fig.36
Input Offset Current - Supply Voltage
(Vicm=0V, Vout=0V)

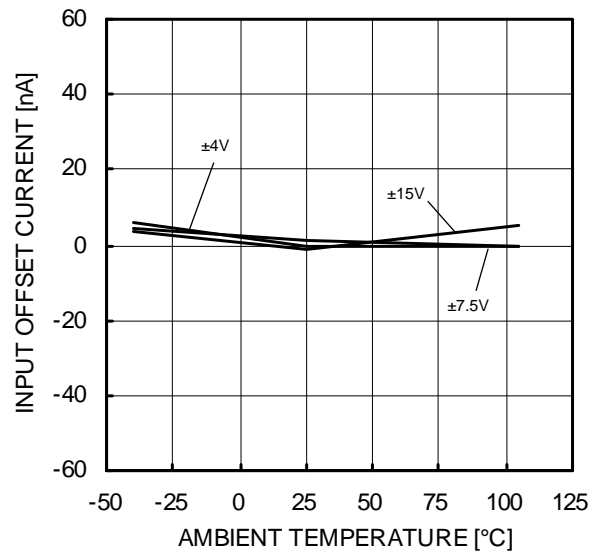

Fig.37
Input Offset Current - Ambient Temperature
(Vicm=0V, Vout=0V)

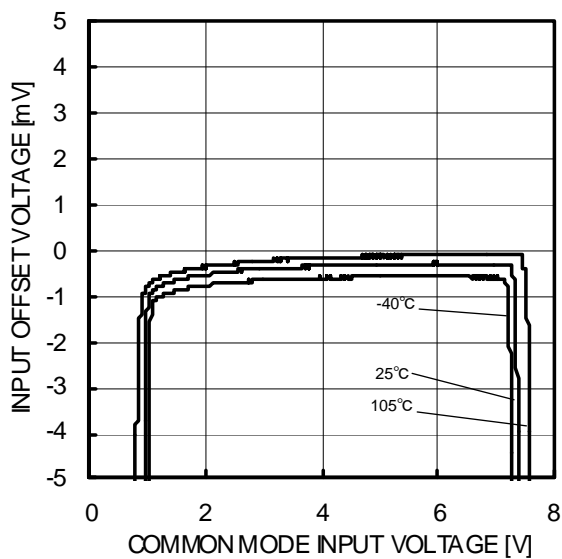

Fig.38
Input Offset Voltage
- Common Mode Input Voltage
(VCC=8V, Vout=4V)

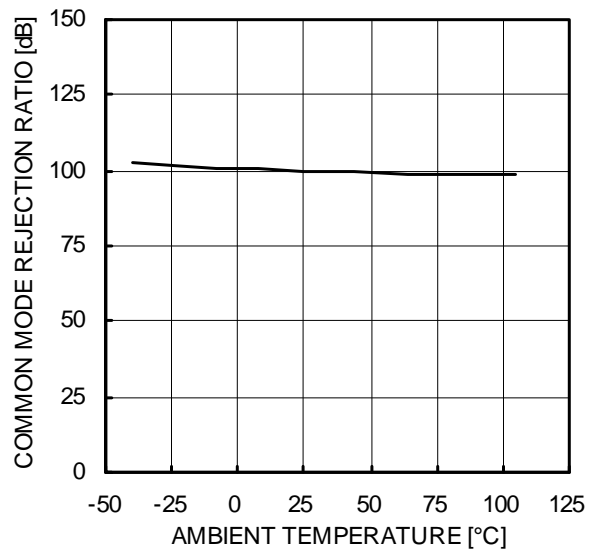

Fig.39
Common Mode Rejection Ratio
- Ambient Temperature
(VCC/VEE=+15V/-15V, Vicm=-12V to +12V)

(*) The above data is measurement value of typical sample, it is not guaranteed.

○ BA4558R

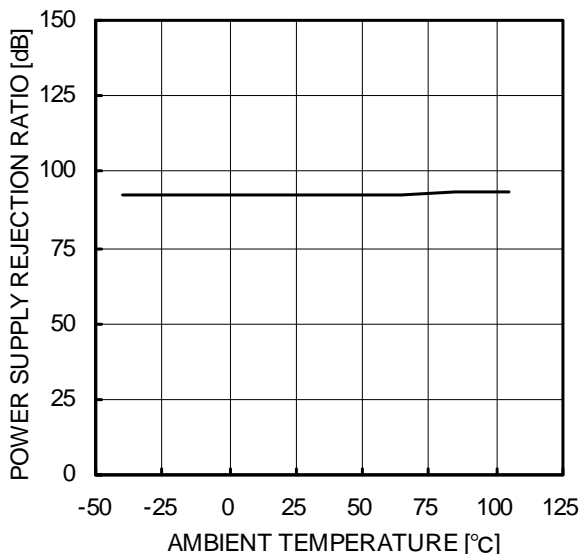

Fig.40
Power Supply Rejection Ratio
- Ambient Temperature
(VCC/VEE=+4V/-4V to +15V/-15V)

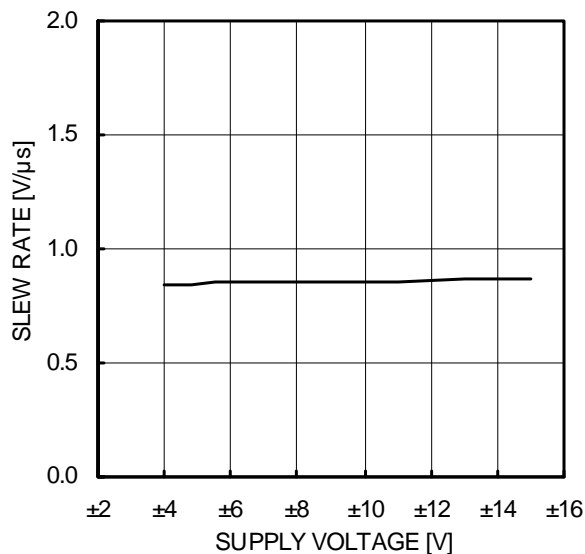

Fig.41
Slew Rate - Supply Voltage
(CL=100pF, RL=2kΩ, Ta=25°C)

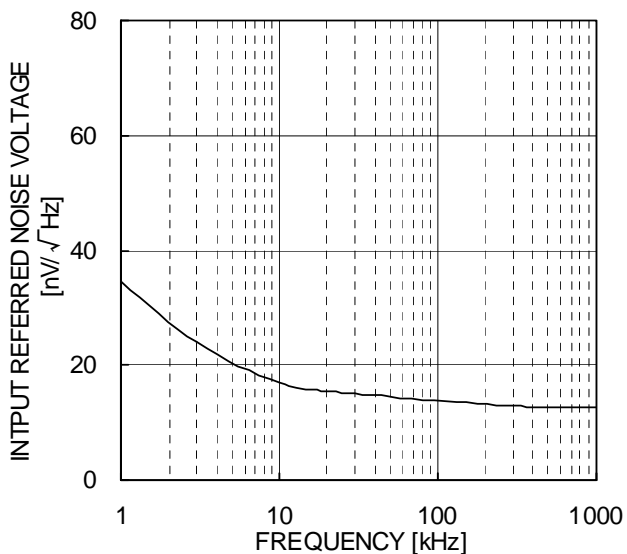

Fig.42
Equivalent Input Noise Voltage - Frequency
(VCC/VEE=+15V/-15V, RS=100Ω, Ta=25°C)

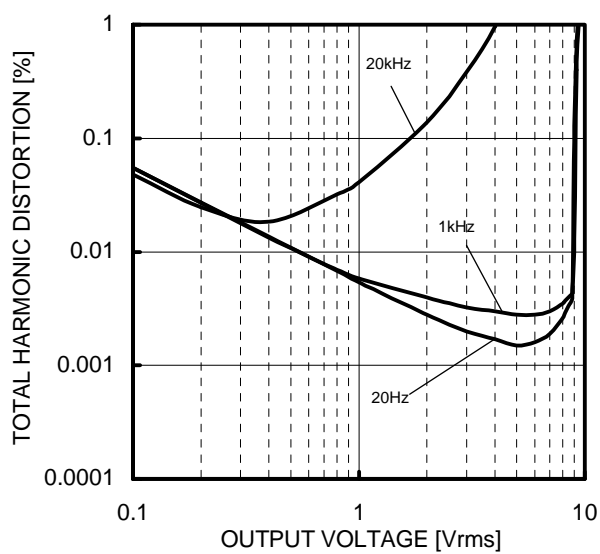

Fig.43
Total Harmonic Distortion - Output Voltage
(VCC/VEE=+15V/-15V, AV=20dB, RL=2kΩ, 80kHz-LPF, Ta=25°C)

(*) The above data is measurement value of typical sample, it is not guaranteed.

○ BA4558R

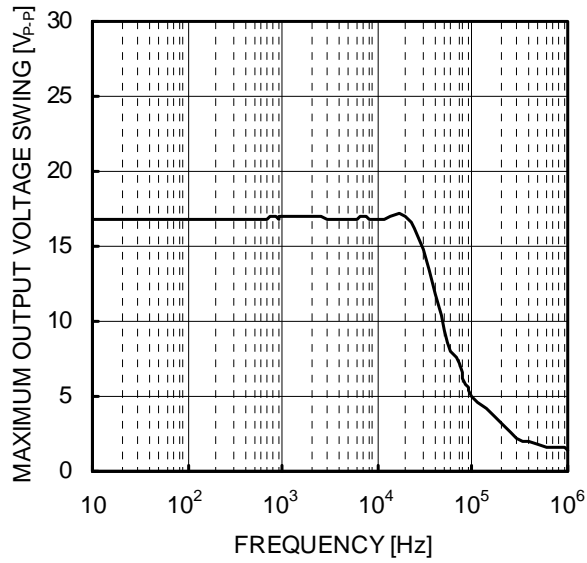

Fig.44
Maximum Output Voltage Swing – Frequency
(VCC/VEE=+15V/-15V, RL=2kΩ, Ta=25°C)

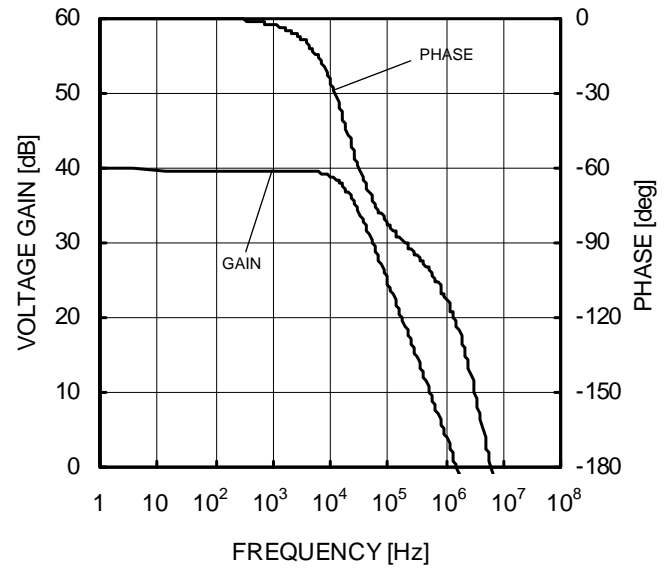

Fig.45
Voltage Gain - Frequency
(VCC/VEE=+15V/-15V, AV=40dB, RL=2kΩ, Ta=25°C)

(*) The above data is measurement value of typical sample, it is not guaranteed.

●Application Information
Test circuit1 NULL method

VCC, VEE, EK, Vicm Unit: V

Parameter	VF	S1	S2	S3	VCC	VEE	EK	Vicm	calculation
Input Offset Voltage	VF1	ON	ON	OFF	15	-15	0	0	1
Input Offset Current	VF2	OFF	OFF	OFF	15	-15	0	0	2
Input Bias Current	VF3	OFF	ON	OFF	15	-15	0	0	3
	VF4	ON	OFF						
Large Signal Voltage Gain	VF5	ON	ON	ON	15	-15	0	0	4
	VF6				15	-15	0	0	
Common-mode Rejection Ratio (Input common-mode Voltage Range)	VF7	ON	ON	OFF	3	-27	0	0	5
	VF8				27	-3	0	0	
Power Supply Rejection Ratio	VF9	ON	ON	OFF	4	-4	0	0	6
	VF10				15	-15	0	0	

-Calculation-

1. Input Offset Voltage (Vio)

$$V_{io} = \frac{|VF1|}{1+R_f/R_s} \text{ [V]}$$

2. Input Offset Current (Iio)

$$I_{io} = \frac{|VF2 - VF1|}{R_i \times (1+R_f/R_s)} \text{ [A]}$$

3. Input Bias Current (Ib)

$$I_b = \frac{|VF4 - VF3|}{2 \times R_i \times (1+R_f/R_s)} \text{ [A]}$$

4. Large Signal Voltage Gain (Av)

$$A_v = 20 \times \text{Log} \frac{\Delta EK \times (1+R_f/R_s)}{|VF5 - VF6|} \text{ [dB]}$$

5. Common-mode Rejection Ration (CMRR)

$$CMRR = 20 \times \text{Log} \frac{\Delta Vicm \times (1+R_f/R_s)}{|VF8 - VF7|} \text{ [dB]}$$

6. Power supply rejection ratio (PSRR)

$$PSRR = 20 \times \text{Log} \frac{\Delta V_{cc} \times (1+R_f/R_s)}{|VF10 - VF9|} \text{ [dB]}$$

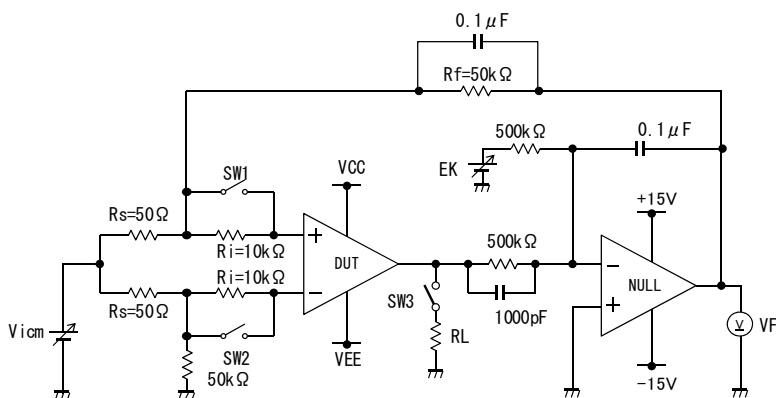

Fig. 46 Test circuit1 (one channel only)

Test Circuit 2 Switch Condition

SW No.	SW1	SW2	SW3	SW4	SW5	SW6	SW7	SW8	SW9	SW10	SW11	SW12	SW13	SW14
Supply Current	OFF	OFF	OFF	ON	OFF	ON	OFF	OFF	OFF	OFF	OFF	OFF	OFF	OFF
High Level Output Voltage	OFF	OFF	ON	OFF	OFF	ON	OFF	OFF	ON	OFF	OFF	OFF	ON	OFF
Low Level Output Voltage	OFF	OFF	ON	OFF	OFF	ON	OFF	OFF	OFF	OFF	OFF	OFF	ON	OFF
Slew Rate	OFF	OFF	OFF	ON	OFF	OFF	OFF	ON	ON	ON	OFF	OFF	OFF	OFF
Gain Bandwidth Product	OFF	ON	OFF	OFF	ON	ON	OFF	OFF	ON	ON	OFF	OFF	OFF	OFF
Equivalent Input Noise Voltage	ON	OFF	OFF	OFF	ON	ON	OFF	OFF	OFF	OFF	ON	OFF	OFF	OFF

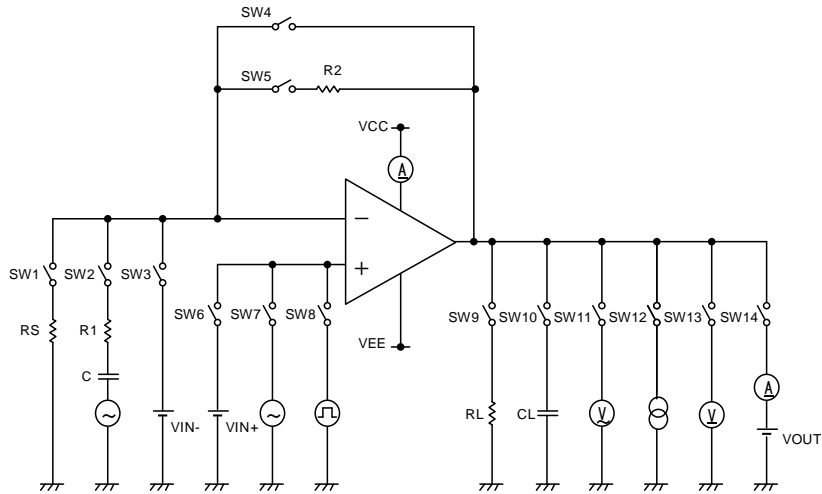

Fig.47 Test Circuit 2 (each Op-Amp)

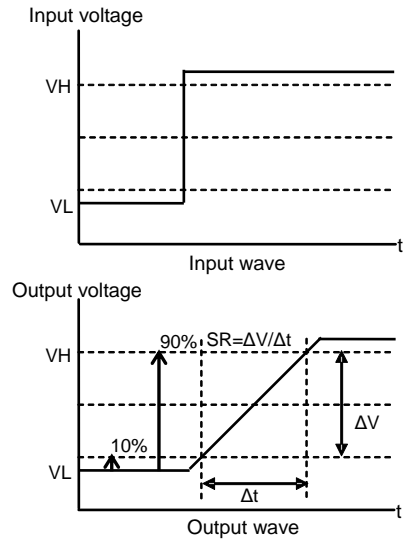

Fig. 48 Slew Rate Input Waveform

Test Circuit 3 Channel Separation

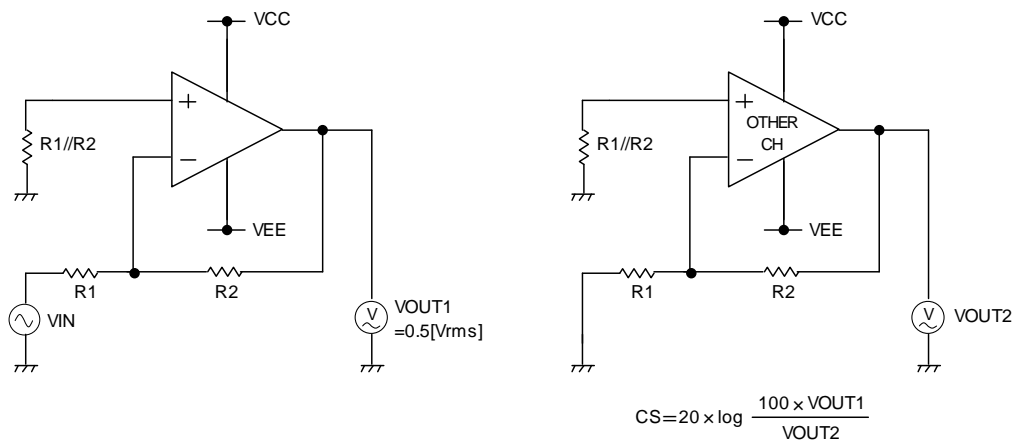

Fig. 49 Test circuit 3
(VCC=+15V, VEE=-15V, R1=1kΩ, R2=100kΩ)

● Power Dissipation

Power dissipation(total loss) indicates the power that can be consumed by IC at Ta=25°C(normal temperature). IC is heated when it consumed power, and the temperature of IC chip becomes higher than ambient temperature. The temperature that can be accepted by IC chip depends on circuit configuration, manufacturing process, and consumable power is limited. Power dissipation is determined by the temperature allowed in IC chip(maximum junction temperature) and thermal resistance of package(heat dissipation capability). The maximum junction temperature is typically equal to the maximum value in the storage temperature range. Heat generated by consumed power of IC radiates from the mold resin or lead frame of the package. The parameter which indicates this heat dissipation capability(hardness of heat release)is called thermal resistance, represented by the symbol θ_{ja} °C/W.The temperature of IC inside the package can be estimated by this thermal resistance. Fig.50(a) shows the model of thermal resistance of the package. Thermal resistance θ_{ja} , ambient temperature Ta, junction temperature Tj, and power dissipation Pd can be calculated by the equation below:

$$\theta_{ja} = (T_{jmax} - T_a) / P_d \quad \text{°C/W} \quad \dots \dots \dots (I)$$

Derating curve in Fig.50 (b) indicates power that can be consumed by IC with reference to ambient temperature. Power that can be consumed by IC begins to attenuate at certain ambient temperature. This gradient is determined by thermal resistance θ_{ja} . Thermal resistance θ_{ja} depends on chip size, power consumption, package, ambient temperature, package condition, wind velocity, etc even when the same of package is used. Thermal reduction curve indicates a reference value measured at a specified condition. Fig.51(c),(d) show a derating curve for an example of BA4558, BA4558R.

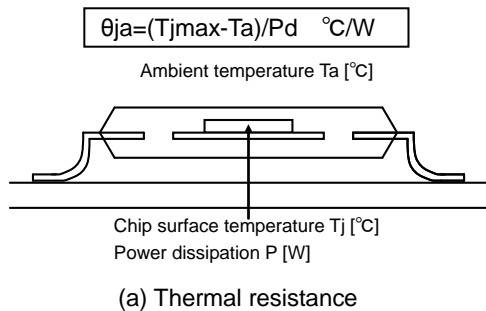

Power dissipation of LSI [W]

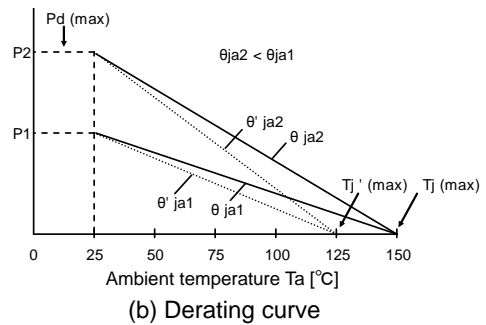
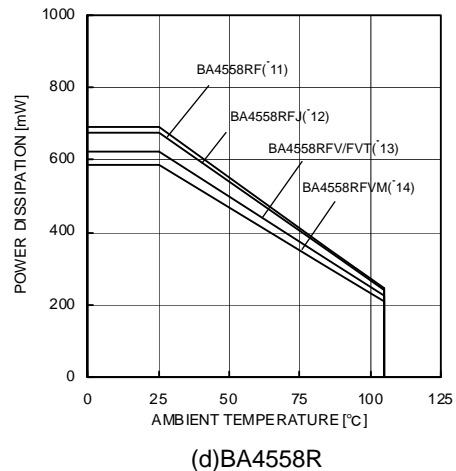
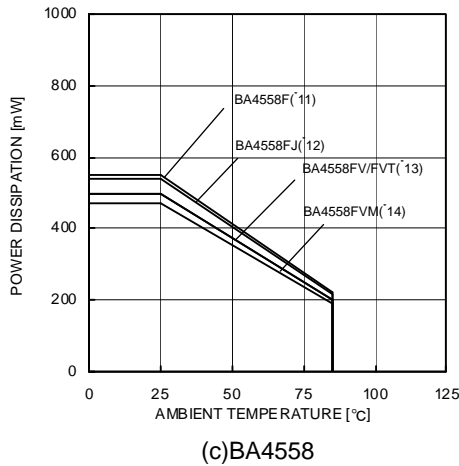

Fig. 50 Thermal resistance and derating curve



(*11)	(*12)	(*13)	(*14)	Unit
5.52	5.4	5	4.7	mW/°C

When using the unit above Ta=25°C, subtract the value above per degree°C. Permissible dissipation is the value. Permissible dissipation is the value when FR4 glass epoxy board 70mm x70mm x1.6mm (cooper foil area below 3%) is mounted.

Fig. 51 Derating curve

Examples of circuit

○Voltage follower

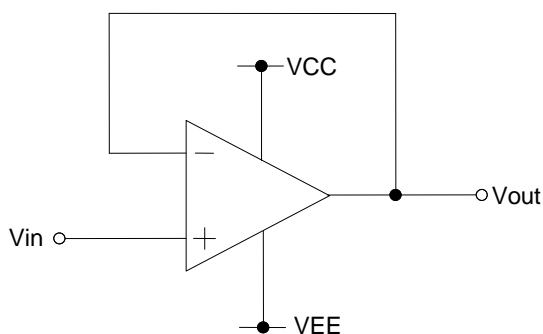

Fig. 52 Voltage follower circuit

Voltage gain is 0 dB.

This circuit controls output voltage (V_{out}) equal input voltage (V_{in}), and keeps V_{out} with stable because of high input impedance and low output impedance. V_{out} is shown next formula.

$$V_{out} = V_{in}$$

○Inverting amplifier

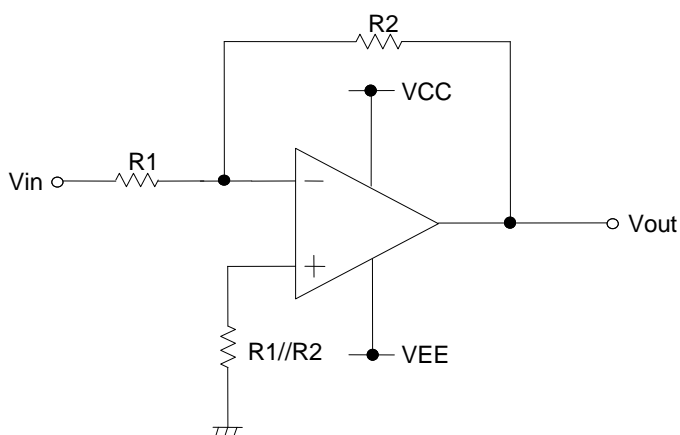

Fig. 53 Inverting amplifier circuit

For inverting amplifier, $V_i(b)$ Derating curve voltage gain decided R_1 and R_2 , and phase reversed voltage is outputted.

V_{out} is shown next formula.

$$V_{out} = -(R_2/R_1) \cdot V_{in}$$

Input impedance is R_1 .

○Non-inverting amplifier

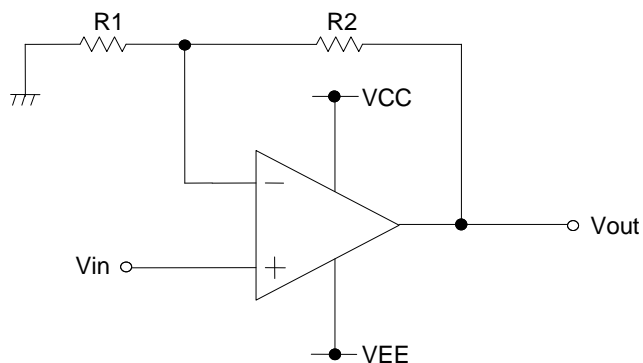

Fig. 54 Non-inverting amplifier circuit

For non-inverting amplifier, V_{in} is amplified by voltage gain decided R_1 and R_2 , and phase is same with V_{in} .

V_{out} is shown next formula.

$$V_{out} = (1 + R_2/R_1) \cdot V_{in}$$

This circuit realizes high input impedance because Input impedance is operational amplifier's input Impedance.

●Operational Notes

- 1) Processing of unused circuit
It is recommended to apply connection (see the Fig.55) and set the non inverting input terminal at the potential within input common-mode voltage range (V_{icm}), for any unused circuit.
- 2) Input voltage
Applying $(V_{EE} - 0.3)$ to $(V_{EE} + 36)V$ (BA4558R) to the input terminal is possible without causing deterioration of the electrical characteristics or destruction, irrespective of the supply voltage. However, this does not ensure normal circuit operation. Please note that the circuit operates normally only when the input voltage is within the common mode input voltage range of the electric characteristics.
- 3) Maximum output voltage
Because the output voltage range becomes narrow as the output current increases, design the application with margin by considering changes in electrical characteristics and temperature characteristics.
- 4) Short-circuit of output terminal
When output terminal and VCC or VEE terminal are shorted, excessive Output current may flow under some conditions, and heating may destroy IC. It is necessary to connect a resistor as shown in Fig.56, thereby protecting against load shorting.
- 5) Power supply (split supply / single supply) in used
Op-amp operates when specified voltage is applied between VCC and VEE. Therefore, the single supply Op-Amp can be used for double supply Op-Amp as well.
- 6) Power dissipation (P_d)
Use a thermal design that allows for a sufficient margin in light of the power dissipation (P_d) in actual operating conditions.
- 7) Short-circuit between pins and wrong mounting
Pay attention to the assembly direction of the ICs. Wrong mounting direction or shorts between terminals, GND, or other components on the circuits, can damage the IC.
- 8) Use in strong electromagnetic field
Using the ICs in strong electromagnetic field can cause operation malfunction.
- 9) Radiation
This IC is not designed to be radiation-resistant.
- 10) IC Handling
When stress is applied to IC because of deflection or bend of board, the characteristics may fluctuate due to piezoelectric (piezo) effect.
- 11) Inspection on set board
During testing, turn on or off the power before mounting or dismantling the board from the test Jig. Do not power up the board without waiting for the output capacitors to discharge. The capacitors in the low output impedance terminal can stress the device. Pay attention to the electro static voltages during IC handling, transportation, and storage.
- 12) Output capacitor
When VCC terminal is shorted to VEE (GND) potential and an electric charge has accumulated on the external capacitor, connected to output terminal, accumulated charge may be discharged VCC terminal via the parasitic element within the circuit or terminal protection element. The element in the circuit may be damaged (thermal destruction). When using this IC for an application circuit where there is oscillation, output capacitor load does not occur, as when using this IC as a voltage comparator. Set the capacitor connected to output terminal below $0.1\mu F$ in order to prevent damage to IC.

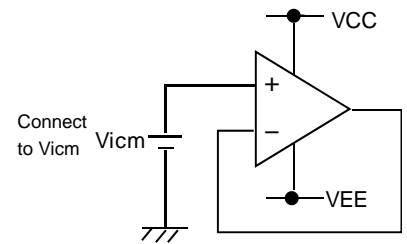

Fig. 55 The example of application circuit for unused op-amp

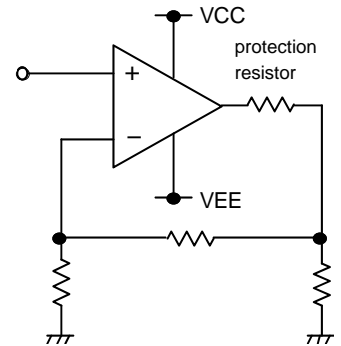

Fig. 56 The example of output short protection

Status of this document

The Japanese version of this document is formal specification. A customer may use this translation version only for a reference to help reading the formal version.

If there are any differences in translation version of this document formal version takes priority.

●Physical Dimensions Tape and Reel Information

SOP8

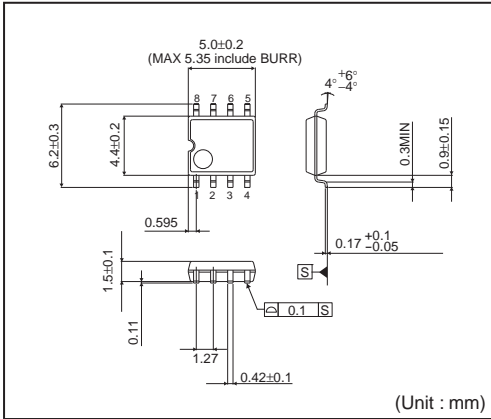

<Tape and Reel information>

Tape	Embossed carrier tape
Quantity	2500pcs
Direction of feed	E2 (The direction is the 1pin of product is at the upper left when you hold reel on the left hand and you pull out the tape on the right hand)

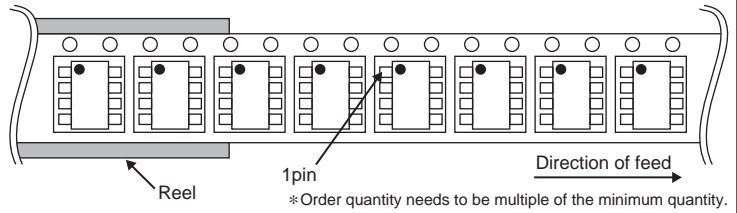

SSOP-B8

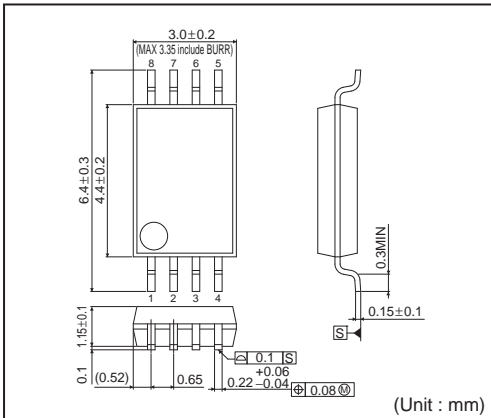

<Tape and Reel information>

Tape	Embossed carrier tape
Quantity	2500pcs
Direction of feed	E2 (The direction is the 1pin of product is at the upper left when you hold reel on the left hand and you pull out the tape on the right hand)

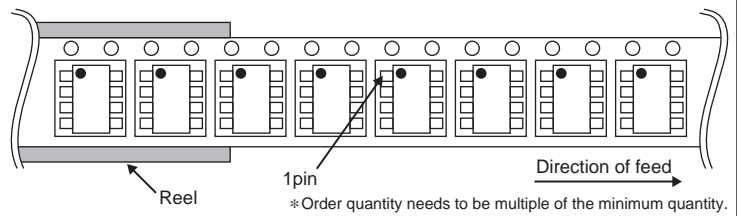

MSOP8

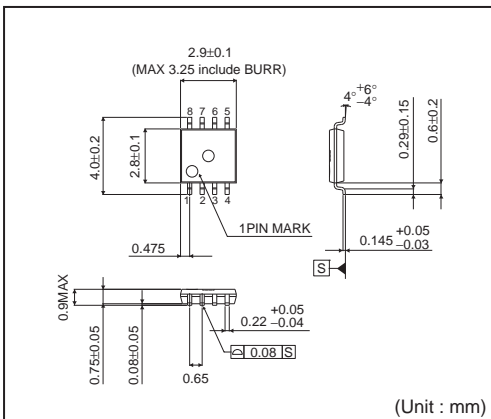

<Tape and Reel information>

Tape	Embossed carrier tape
Quantity	3000pcs
Direction of feed	TR (The direction is the 1pin of product is at the upper right when you hold reel on the left hand and you pull out the tape on the right hand)

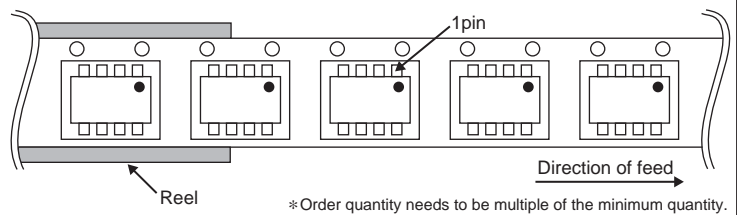

TSSOP-B8

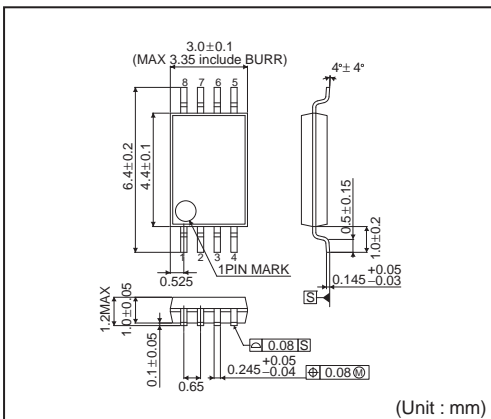

<Tape and Reel information>

Tape	Embossed carrier tape
Quantity	3000pcs
Direction of feed	E2 (The direction is the 1pin of product is at the upper left when you hold reel on the left hand and you pull out the tape on the right hand)

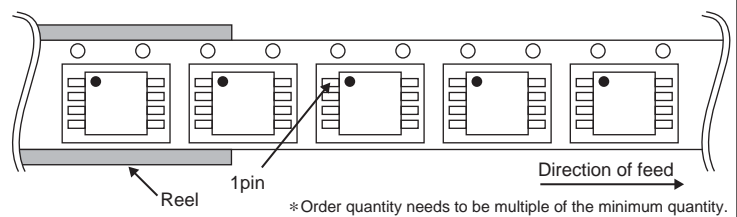

SOP-J8

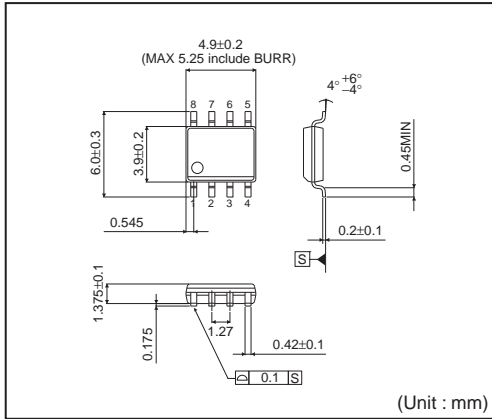

<Tape and Reel information>

Tape	Embossed carrier tape
Quantity	2500pcs
Direction of feed	E2 (The direction is the 1pin of product is at the upper left when you hold reel on the left hand and you pull out the tape on the right hand)

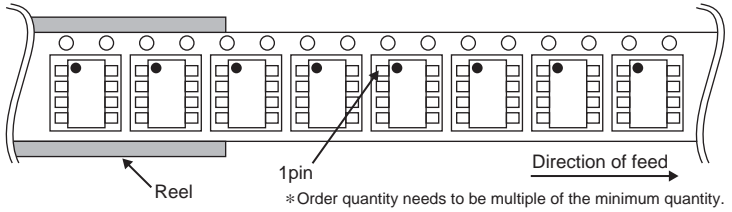

●Marking Diagrams

SOP8(TOP VIEW)

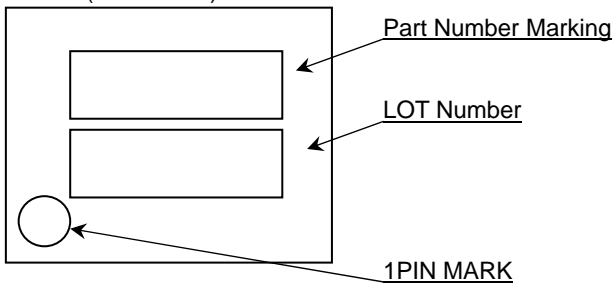

SSOP-B8(TOP VIEW)

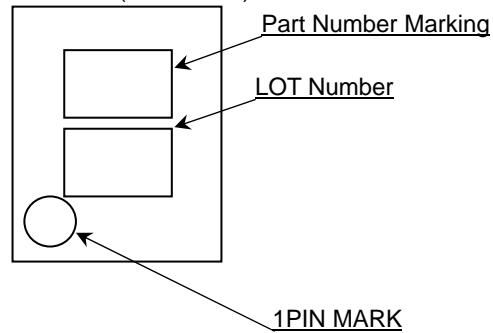

MSOP8(TOP VIEW)

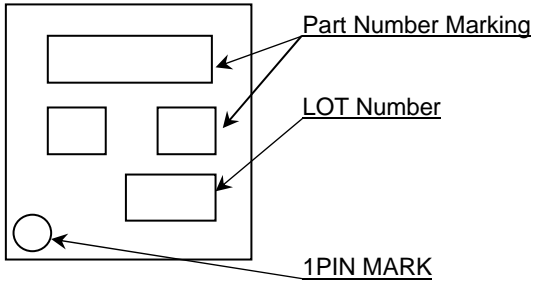

TSSOP-B8(TOP VIEW)

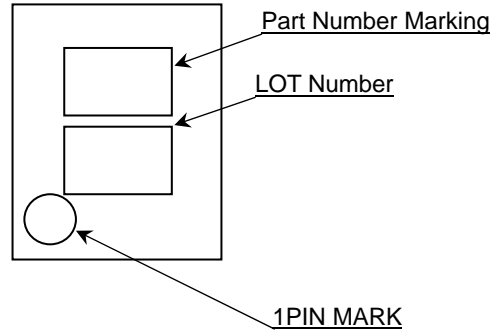

SOP-J8(TOP VIEW)

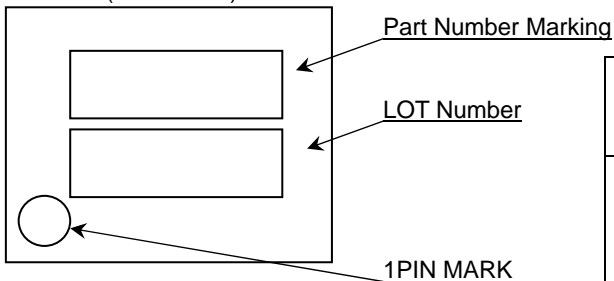

Product Name		Package Type	Marking
BA4558	F	SOP8	4558
	FV	SSOP-B8	
	FVT	TSSOP-B8	
	FVM	MSOP8	
	FJ	SOP-J8	
BA4558R	F	SOP8	4558R
	FV	SSOP-B8	
	FVT	TSSOP-B8	
	FVM	MSOP8	
	FJ	SOP-J8	

Notice

Precaution on using ROHM Products

- Our Products are designed and manufactured for application in ordinary electronic equipments (such as AV equipment, OA equipment, telecommunication equipment, home electronic appliances, amusement equipment, etc.). If you intend to use our Products in devices requiring extremely high reliability (such as medical equipment ^(Note 1), transport equipment, traffic equipment, aircraft/spacecraft, nuclear power controllers, fuel controllers, car equipment including car accessories, safety devices, etc.) and whose malfunction or failure may cause loss of human life, bodily injury or serious damage to property ("Specific Applications"), please consult with the ROHM sales representative in advance. Unless otherwise agreed in writing by ROHM in advance, ROHM shall not be in any way responsible or liable for any damages, expenses or losses incurred by you or third parties arising from the use of any ROHM's Products for Specific Applications.

(Note1) Medical Equipment Classification of the Specific Applications

JAPAN	USA	EU	CHINA
CLASS III	CLASS III	CLASS II b	CLASS III
CLASS IV		CLASS III	

- ROHM designs and manufactures its Products subject to strict quality control system. However, semiconductor products can fail or malfunction at a certain rate. Please be sure to implement, at your own responsibilities, adequate safety measures including but not limited to fail-safe design against the physical injury, damage to any property, which a failure or malfunction of our Products may cause. The following are examples of safety measures:
 - Installation of protection circuits or other protective devices to improve system safety
 - Installation of redundant circuits to reduce the impact of single or multiple circuit failure
- Our Products are designed and manufactured for use under standard conditions and not under any special or extraordinary environments or conditions, as exemplified below. Accordingly, ROHM shall not be in any way responsible or liable for any damages, expenses or losses arising from the use of any ROHM's Products under any special or extraordinary environments or conditions. If you intend to use our Products under any special or extraordinary environments or conditions (as exemplified below), your independent verification and confirmation of product performance, reliability, etc. prior to use, must be necessary:
 - Use of our Products in any types of liquid, including water, oils, chemicals, and organic solvents
 - Use of our Products outdoors or in places where the Products are exposed to direct sunlight or dust
 - Use of our Products in places where the Products are exposed to sea wind or corrosive gases, including Cl₂, H₂S, NH₃, SO₂, and NO₂
 - Use of our Products in places where the Products are exposed to static electricity or electromagnetic waves
 - Use of our Products in proximity to heat-producing components, plastic cords, or other flammable items
 - Sealing or coating our Products with resin or other coating materials
 - Use of our Products without cleaning residue of flux (even if you use no-clean type fluxes, cleaning residue of flux is recommended); or Washing our Products by using water or water-soluble cleaning agents for cleaning residue after soldering
 - Use of the Products in places subject to dew condensation
- The Products are not subject to radiation-proof design.
- Please verify and confirm characteristics of the final or mounted products in using the Products.
- In particular, if a transient load (a large amount of load applied in a short period of time, such as pulse. is applied, confirmation of performance characteristics after on-board mounting is strongly recommended. Avoid applying power exceeding normal rated power; exceeding the power rating under steady-state loading condition may negatively affect product performance and reliability.
- De-rate Power Dissipation (Pd) depending on Ambient temperature (Ta). When used in sealed area, confirm the actual ambient temperature.
- Confirm that operation temperature is within the specified range described in the product specification.
- ROHM shall not be in any way responsible or liable for failure induced under deviant condition from what is defined in this document.

Precaution for Mounting / Circuit board design

- When a highly active halogenous (chlorine, bromine, etc.) flux is used, the residue of flux may negatively affect product performance and reliability.
- In principle, the reflow soldering method must be used; if flow soldering method is preferred, please consult with the ROHM representative in advance.

For details, please refer to ROHM Mounting specification

Precautions Regarding Application Examples and External Circuits

1. If change is made to the constant of an external circuit, please allow a sufficient margin considering variations of the characteristics of the Products and external components, including transient characteristics, as well as static characteristics.
2. You agree that application notes, reference designs, and associated data and information contained in this document are presented only as guidance for Products use. Therefore, in case you use such information, you are solely responsible for it and you must exercise your own independent verification and judgment in the use of such information contained in this document. ROHM shall not be in any way responsible or liable for any damages, expenses or losses incurred by you or third parties arising from the use of such information.

Precaution for Electrostatic

This Product is electrostatic sensitive product, which may be damaged due to electrostatic discharge. Please take proper caution in your manufacturing process and storage so that voltage exceeding the Products maximum rating will not be applied to Products. Please take special care under dry condition (e.g. Grounding of human body / equipment / solder iron, isolation from charged objects, setting of ionizer, friction prevention and temperature / humidity control).

Precaution for Storage / Transportation

1. Product performance and soldered connections may deteriorate if the Products are stored in the places where:
 - [a] the Products are exposed to sea winds or corrosive gases, including Cl₂, H₂S, NH₃, SO₂, and NO₂
 - [b] the temperature or humidity exceeds those recommended by ROHM
 - [c] the Products are exposed to direct sunshine or condensation
 - [d] the Products are exposed to high Electrostatic
2. Even under ROHM recommended storage condition, solderability of products out of recommended storage time period may be degraded. It is strongly recommended to confirm solderability before using Products of which storage time is exceeding the recommended storage time period.
3. Store / transport cartons in the correct direction, which is indicated on a carton with a symbol. Otherwise bent leads may occur due to excessive stress applied when dropping of a carton.
4. Use Products within the specified time after opening a humidity barrier bag. Baking is required before using Products of which storage time is exceeding the recommended storage time period.

Precaution for Product Label

QR code printed on ROHM Products label is for ROHM's internal use only.

Precaution for Disposition

When disposing Products please dispose them properly using an authorized industry waste company.

Precaution for Foreign Exchange and Foreign Trade act

Since our Products might fall under controlled goods prescribed by the applicable foreign exchange and foreign trade act, please consult with ROHM representative in case of export.

Precaution Regarding Intellectual Property Rights

1. All information and data including but not limited to application example contained in this document is for reference only. ROHM does not warrant that foregoing information or data will not infringe any intellectual property rights or any other rights of any third party regarding such information or data. ROHM shall not be in any way responsible or liable for infringement of any intellectual property rights or other damages arising from use of such information or data.:
2. No license, expressly or implied, is granted hereby under any intellectual property rights or other rights of ROHM or any third parties with respect to the information contained in this document.

Other Precaution

1. This document may not be reprinted or reproduced, in whole or in part, without prior written consent of ROHM.
2. The Products may not be disassembled, converted, modified, reproduced or otherwise changed without prior written consent of ROHM.
3. In no event shall you use in any way whatsoever the Products and the related technical information contained in the Products or this document for any military purposes, including but not limited to, the development of mass-destruction weapons.
4. The proper names of companies or products described in this document are trademarks or registered trademarks of ROHM, its affiliated companies or third parties.

General Precaution

1. Before you use our Products, you are requested to carefully read this document and fully understand its contents. ROHM shall not be in any way responsible or liable for failure, malfunction or accident arising from the use of any ROHM's Products against warning, caution or note contained in this document.
2. All information contained in this document is current as of the issuing date and subject to change without any prior notice. Before purchasing or using ROHM's Products, please confirm the latest information with a ROHM sales representative.
3. The information contained in this document is provided on an "as is" basis and ROHM does not warrant that all information contained in this document is accurate and/or error-free. ROHM shall not be in any way responsible or liable for any damages, expenses or losses incurred by you or third parties resulting from inaccuracy or errors of or concerning such information.



Компания «ЭлектроПласт» предлагает заключение долгосрочных отношений при поставках импортных электронных компонентов на взаимовыгодных условиях!

Наши преимущества:

- Оперативные поставки широкого спектра электронных компонентов отечественного и импортного производства напрямую от производителей и с крупнейших мировых складов;
- Поставка более 17-ти миллионов наименований электронных компонентов;
- Поставка сложных, дефицитных, либо снятых с производства позиций;
- Оперативные сроки поставки под заказ (от 5 рабочих дней);
- Экспресс доставка в любую точку России;
- Техническая поддержка проекта, помощь в подборе аналогов, поставка прототипов;
- Система менеджмента качества сертифицирована по Международному стандарту ISO 9001;
- Лицензия ФСБ на осуществление работ с использованием сведений, составляющих государственную тайну;
- Поставка специализированных компонентов (Xilinx, Altera, Analog Devices, Intersil, Interpoint, Microsemi, Aeroflex, Peregrine, Syfer, Eurofarad, Texas Instrument, Miteq, Cobham, E2V, MA-COM, Hittite, Mini-Circuits, General Dynamics и др.);

Помимо этого, одним из направлений компании «ЭлектроПласт» является направление «Источники питания». Мы предлагаем Вам помощь Конструкторского отдела:

- Подбор оптимального решения, техническое обоснование при выборе компонента;
- Подбор аналогов;
- Консультации по применению компонента;
- Поставка образцов и прототипов;
- Техническая поддержка проекта;
- Защита от снятия компонента с производства.



Как с нами связаться

Телефон: 8 (812) 309 58 32 (многоканальный)

Факс: 8 (812) 320-02-42

Электронная почта: org@eplast1.ru

Адрес: 198099, г. Санкт-Петербург, ул. Калинина, дом 2, корпус 4, литера А.