



## Main

Range of product	Altivar Process ATV600
Product or component type	Variable speed drive
Product specific application	Process and utilities
Device short name	ATV630
Variant	Standard version
Product destination	Asynchronous motors Synchronous motors
Mounting mode	Wall mount
EMC filter	Integrated EN/IEC 61800-3 category C3 <= 50 m
IP degree of protection	IP00 conforming to IEC 60529 IP00 conforming to IEC 61800-5-1 IP21 (with kit VW3A9113) conforming to IEC 61800-5-1 IP21 (with kit VW3A9113) conforming to IEC 60529
Type of cooling	Forced convection
Supply frequency	50...60 Hz - 5...5 %
Network number of phases	3 phases
[Us] rated supply voltage	380...480 V - 15...10 %
Motor power kW	315 kW normal duty 250 kW heavy duty
Motor power hp	500 hp normal duty 400 hp heavy duty
Line current	569 A 380 V normal duty 461 A 480 V normal duty 457 A 380 V heavy duty 375 A 480 V heavy duty
Prospective line I <sub>sc</sub>	50 kA
Apparent power	351 kVA 480 V normal duty 286 kVA 480 V heavy duty
Continuous output current	616 A 2.5 kHz normal duty 481 A 2.5 kHz heavy duty
Maximum transient current	678 A 60 s normal duty 722 A 60 s heavy duty
Asynchronous motor control profile	Constant torque standard Variable torque standard Optimized torque mode
Synchronous motor control profile	Permanent magnet motor Synchronous reluctance motor
Output frequency	0.0001...0.5 kHz
Speed drive output frequency	0.1...599 Hz
Nominal switching frequency	2.5 kHz
Switching frequency	2...8 kHz adjustable 2.5...8 kHz with derating factor
Safety function	STO (safe torque off) SIL 3
Discrete input logic	16 preset speeds
Communication port protocol	Ethernet Modbus serial Modbus TCP
Option card	Communication module Profibus DP V1 slot A Communication module Profinet slot A Communication module DeviceNet slot A Communication module Modbus TCP/EtherNet/IP slot A Communication module CANopen daisy chain

The information provided in this documentation contains general descriptions and/or technical characteristics of the products contained herein. This documentation is not intended as a substitute for and is not to be used for determining suitability or reliability of these products for specific user applications. It is the duty of any such user or integrator to perform the appropriate and complete risk analysis, evaluation and testing of the products with respect to the relevant specific application or use thereof. Neither Schneider Electric Industries SAS nor any of its affiliates or subsidiaries shall be responsible or liable for misuse of the information contained herein.

RJ45 slot A  
 Communication module CANopen SUB-D 9 slot A  
 Communication module CANopen screw terminals slot A  
 Digital and analog I/O extension module slot A/slot B  
 Output relay extension module slot A/slot B  
 Communication module Ethernet IP/Modbus TCP/MD-Link slot A  
 Communication module BACnet MS/TP  
 Communication module Ethernet Powerlink

## Complementary

Output voltage	<= power supply voltage
Permissible temporary current boost	1.1 x In 60 s normal duty 1.5 x In 60 s heavy duty
Motor slip compensation	Adjustable Automatic whatever the load Can be suppressed Not available in permanent magnet motor law
Acceleration and deceleration ramps	Linear adjustable separately from 0.01...9999 s
Braking to standstill	By DC injection
Protection type	Line supply overvoltage drive Line supply phase loss drive Line supply undervoltage drive Overcurrent between output phases and earth drive Thermal protection motor Thermal protection drive Safe torque off motor Motor phase break motor Safe torque off drive Overheating drive Short-circuit protection drive Motor phase break drive Overspeed drive Break on the control circuit drive Overvoltages on the DC bus drive Overload of output voltage drive
Frequency resolution	Display unit Analog input
Electrical connection	Removable screw terminals 0.5...1.5 mm <sup>2</sup> AWG 20...AWG 16 control Screw terminal 4 x 185 mm <sup>2</sup> 3 x 350 kcmil line side Screw terminal 4 x 185 mm <sup>2</sup> 3 x 350 kcmil motor
Connector type	RJ45 Ethernet/Modbus TCP on the remote graphic terminal RJ45 Modbus serial on the remote graphic terminal
Physical interface	2-wire RS 485 Modbus serial
Transmission frame	RTU Modbus serial
Transmission rate	10/100 Mbit/s Ethernet IP/Modbus TCP 4.8, 9.6, 19.2, 38.4 kbit/s Modbus serial
Exchange mode	Half duplex, full duplex, autonegotiation Ethernet/Modbus TCP
Data format	8 bits, configurable odd, even or no parity Modbus serial
Type of polarization	No impedance Modbus serial
Number of addresses	1...247 Modbus serial
Method of access	Slave Modbus TCP
Supply	Internal supply for reference potentiometer (1 to 10 kOhm) 10.5 V DC +/- 5 % <= 10 mA overload and short-circuit protection External supply for digital inputs 24 V DC 19...30 V <= 1.25 mA overload and short-circuit protection Internal supply for digital inputs and STO 24 V DC 21...27 V <= 200 mA overload and short-circuit protection
Local signalling	3 LEDs local diagnostic 3 LEDs dual colour embedded communication status 4 LEDs dual colour communication module status 1 LED red presence of voltage
Width	23.54 in (598 mm)
Height	47.05 in (1195 mm)
Depth	14.96 in (380 mm)
Product weight	447.54 lb(US) (203 kg)

Analogue input number	3
Analogue input type	Software-configurable voltage AI1, AI2, AI3 0...10 V DC 30 kOhm 12 bits Software-configurable current AI1, AI2, AI3 0...20 mA/4...20 mA 250 Ohm 12 bits
Discrete input number	8
Discrete input type	Programmable DI1...DI6 24 V DC 3.5 kOhm Programmable as pulse input DI5, DI6 0...30 kHz 24 V DC Safe torque off STOA, STOB 24 V DC > 2.2 kOhm
Input compatibility	Level 1 PLC EN/IEC 61131-2 DI1...DI6 discrete input Level 1 PLC IEC 65A-68 DI5, DI6 discrete input Level 1 PLC EN/IEC 61131-2 STOA, STOB discrete input
Discrete input logic	Positive logic (source) DI1...DI6 < 5 V > 11 V Negative logic (sink) DI1...DI6 > 16 V < 10 V Positive logic (source) DI5, DI6 < 0.6 V > 2.5 V Positive logic (source) STOA, STOB < 5 V > 11 V
Analogue output number	2
Analogue output type	Software-configurable voltage AO1, AO2 0...10 V DC 470 Ohm 10 bits Software-configurable current AO1, AO2 0...20 mA 10 bits
Sampling duration	2 ms +/- 0.5 ms DI1...DI4 discrete input 5 ms +/- 1 ms DI5, DI6 discrete input 5 ms +/- 0.1 ms AI1, AI2, AI3 analog input 10 ms +/- 1 ms AO1 analog output
Accuracy	+/- 0.6 % AI1, AI2, AI3 for a temperature variation 60 °C analog input +/- 1 % AO1, AO2 for a temperature variation 60 °C analog output
Linearity error	+/- 0.15 % of maximum value analog input AI1, AI2, AI3 +/- 0.2 % analog output AO1, AO2
Relay output number	3
Relay output type	Configurable relay logic R1 fault relay NO/NC 100000 cycles Configurable relay logic R2 sequence relay NO 100000 cycles Configurable relay logic R3 sequence relay NO 100000 cycles
Refresh time	5 ms +/- 0.5 ms R1, R2, R3 relay output
Minimum switching current	5 mA 24 V DC R1, R2, R3 relay output
Maximum switching current	3 A 250 V AC resistive 1 R1, R2, R3 relay output 3 A 30 V DC resistive 1 R1, R2, R3 relay output 2 A 250 V AC inductive 0.4 7 ms R1, R2, R3 relay output 2 A 30 V DC inductive 0.4 7 ms R1, R2, R3 relay output
Isolation	Between power and control terminals
Specific application	Utility
IP degree of protection	IP21
Discrete and process manufacturing	Building - HVAC compressor centrifugal Food and beverage processing other application Mining mineral and metal fan Mining mineral and metal pump Oil and gas fan Water and waste water other application Building - HVAC screw compressor Food and beverage processing pump Food and beverage processing fan Food and beverage processing atomization Oil and gas electro submersible pump (ESP) Oil and gas water injection pump Oil and gas jet fuel pump Oil and gas compressor for refinery Water and waste water centrifuge pump Water and waste water positive displacement pump Water and waste water electro submersible pump (ESP) Water and waste water screw pump Water and waste water lobe compressor Water and waste water screw compressor Water and waste water compressor centrifugal Water and waste water fan Water and waste water conveyor Water and waste water mixer
Power range	250...500 kW 380...440 V 3 phases 250...500 kW 480...500 V 3 phases
Motor starter type	Variable speed drive

## Environment

insulation resistance	> 1 MOhm 500 V DC for 1 minute to earth
-----------------------	---

noise level	68 dB 86/188/EEC
power dissipation in W	7099 W forced convection 769 W natural convection 380 V 2.5 kHz
volume of cooling air	332862.75 Gal/hr(US) (1260 m3/h)
operating position	Vertical +/- 10 degree
THDI	<= 48 % full load IEC 61000-3-12
electromagnetic compatibility	1.2/50 µs - 8/20 µs surge immunity test level 3 IEC 61000-4-5 Electrical fast transient/burst immunity test level 4 IEC 61000-4-4 Electrostatic discharge immunity test level 3 IEC 61000-4-2 Radiated radio-frequency electromagnetic field immunity test level 3 IEC 61000-4-3 Conducted radio-frequency immunity test level 3 IEC 61000-4-6
pollution degree	2 EN/IEC 61800-5-1
vibration resistance	1.5 mm peak to peak 2...13 Hz IEC 60068-2-6 1 gn 13...200 Hz IEC 60068-2-6
shock resistance	15 gn 11 ms IEC 60068-2-27
relative humidity	5...95 % without condensation IEC 60068-2-3
ambient air temperature for operation	14...104 °F (-10...40 °C) without derating 40...60 °C with derating factor
ambient air temperature for storage	-13...158 °F (-25...70 °C)
operating altitude	<= 3280.84 ft (1000 m) without derating 3280.84...9842.52 ft (1000...3000 m) with current derating 1 % per 100 m
environmental characteristic	Chemical pollution resistance class 3C2 EN/IEC 60721-3-3 Dust pollution resistance class 3S2 EN/IEC 60721-3-3
standards	EN/IEC 61800-3 EN/IEC 61800-3 environment 1 category C2 EN/IEC 61800-3 environment 2 category C3 UL 508C EN/IEC 61800-5-1 IEC 61000-3-12 IEC 60721-3 IEC 61508 IEC 13849-1
product certifications	CSA TÜV UL REACH
marking	CE

## Offer Sustainability

Green Premium product	Green Premium product
Compliant - since 1714 - Schneider Electric declaration of conformity	Compliant - since 1714 - Schneider Electric declaration of conformity
Reference not containing SVHC above the threshold	Reference not containing SVHC above the threshold
Available	Available
Available	Available
WARNING: This product can expose you to chemicals including:	WARNING: This product can expose you to chemicals including:
Lead and lead compounds, which is known to the State of California to cause cancer and birth defects or other reproductive harm.	Lead and lead compounds, which is known to the State of California to cause cancer and birth defects or other reproductive harm.
For more information go to <a href="http://www.p65warnings.ca.gov">www.p65warnings.ca.gov</a>	For more information go to <a href="http://www.p65warnings.ca.gov">www.p65warnings.ca.gov</a>

## Dimensions

### Rear, Right and Front Views

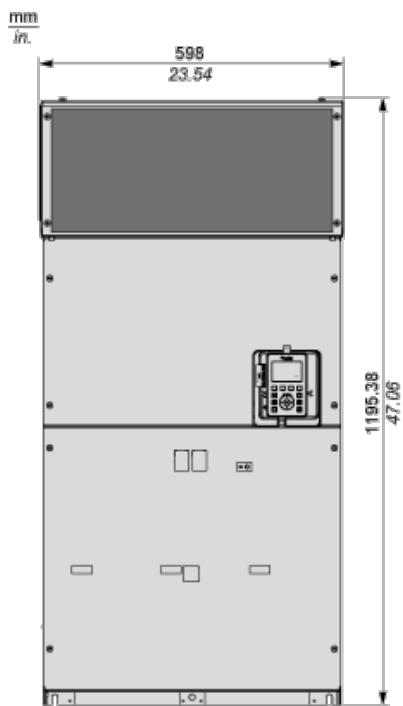
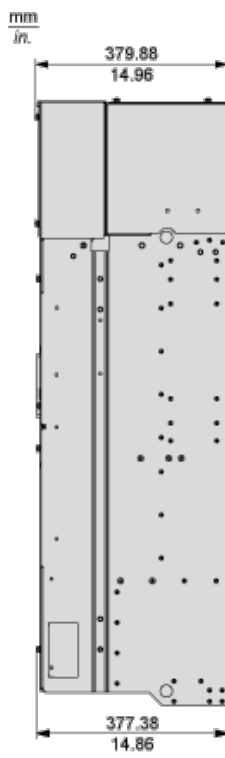
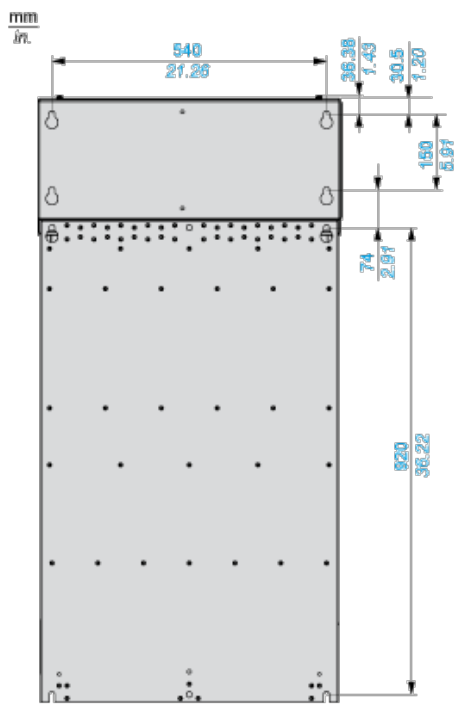

## Clearances

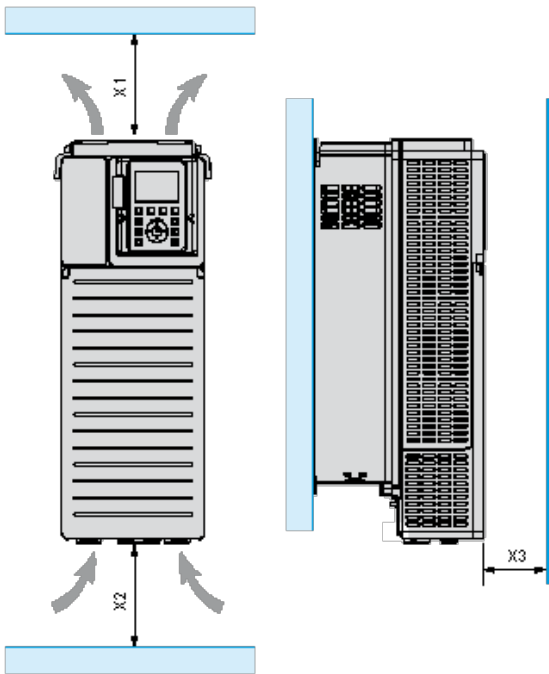

X1	X2	X3
$\geq 200 \text{ mm (7.87 in.)}$	$\geq 150 \text{ mm (5.91 in.)}$	$\geq 10 \text{ mm (0.39 in.)}$

## Mounting Types

### Mounting Type A: Individual IP21

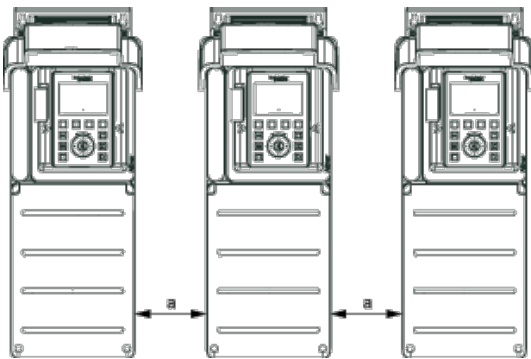

$a \geq 0$

### Mounting Type B: Side by Side IP20

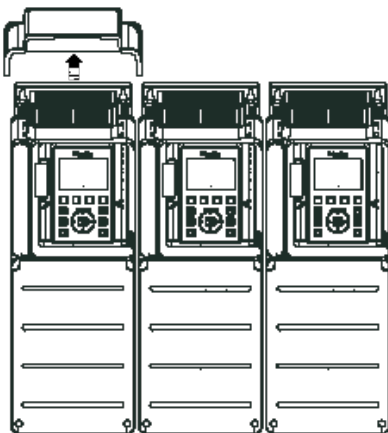

### Mounting Type C: Individual IP20

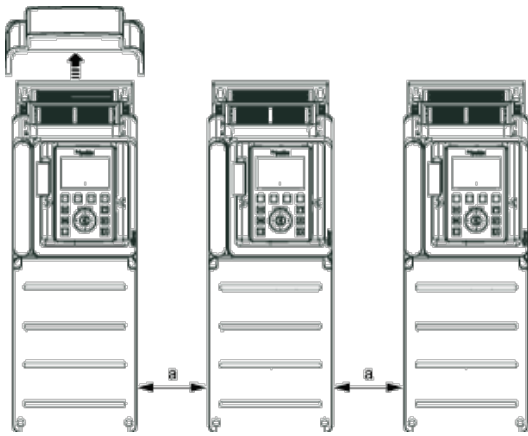

$a \geq 0$

### Three-Phase Power Supply with Upstream Breaking via Line Contactor

Connection diagrams conforming to standards EN 954-1 category 1 and IEC/EN 61508 capacity SIL1, stopping category 0 in accordance with standard IEC/EN 60204-1

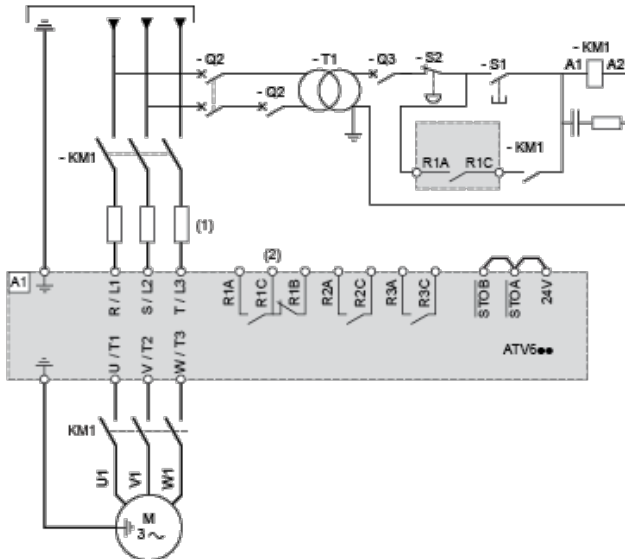

- (1) Line choke if used
  - (2) Use relay R1 set to operating state Fault to switch Off the product once an error is detected.
- A1 : Drive  
 KM1 :Line Contactor  
 Q2, Circuit breakers  
 Q3 :  
 S1, Pushbuttons  
 S2 :  
 T1 : Transformer for control part

### Three-Phase Power Supply with Downstream Breaking via Contactor

Connection diagrams conforming to standards EN 954-1 category 1 and IEC/EN 61508 capacity SIL1, stopping category 0 in accordance with standard IEC/EN 60204-1

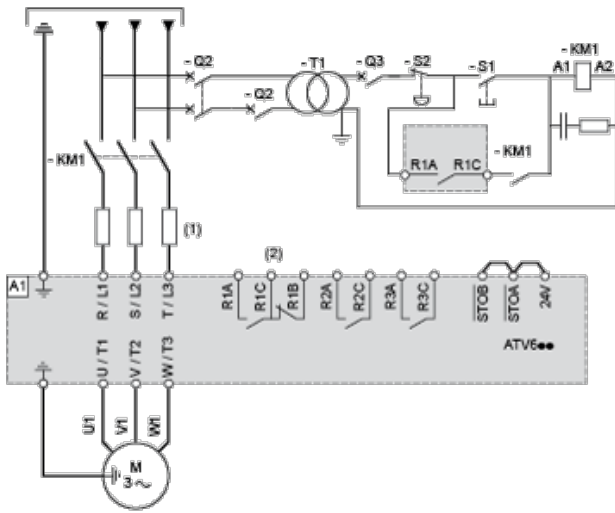

- (1) Line choke if used
  - (2) Use relay R1 set to operating state Fault to switch Off the product once an error is detected.
- A1 : Drive  
 KM1 : Contactor

### Control Block Wiring Diagram

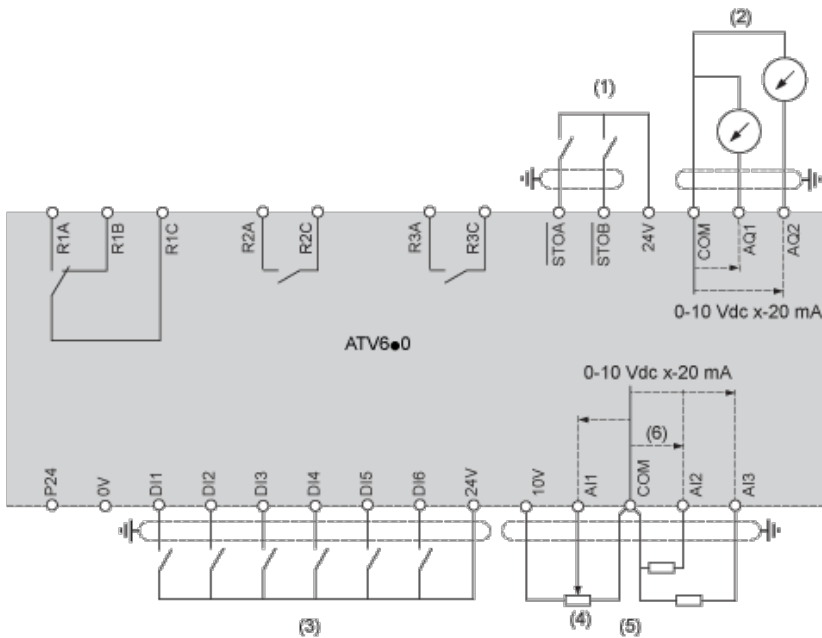

- (1) Safe Torque Off
- (2) Analog Output
- (3) Digital Input
- (4) Reference potentiometer
- (5) Analog Input

R1A, Fault relay  
 R1B,  
 R1C :  
 R2A, Sequence relay  
 R2C :  
 R3A, Sequence relay  
 R3C :

### Sensor Connection

It is possible to connect either 1 or 3 sensors on terminals AI2 or AI3.



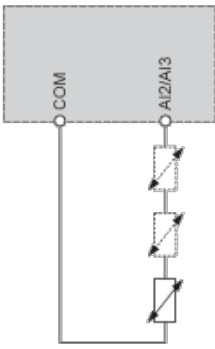

## Sink / Source Switch Configuration

The switch is used to adapt the operation of the logic inputs to the technology of the programmable controller outputs.

- ▮ Set the switch to Source (factory setting) if using PLC outputs with PNP transistors.
- ▮ Set the switch to Ext if using PLC outputs with NPN transistors.

### Switch Set to SRC (Source) Position Using the Output Power Supply for the Digital Inputs

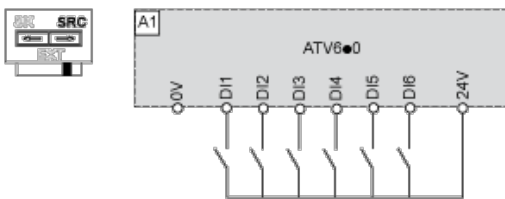

### Switch Set to SRC (Source) Position and Use of an External Power Supply for the DIs

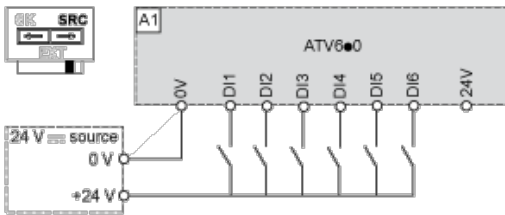

### Switch Set to SK (Sink) Position Using the Output Power Supply for the Digital Inputs

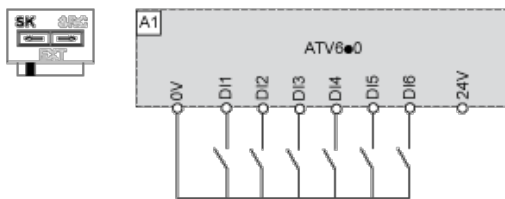

### Switch Set to EXT Position Using an External Power Supply for the DIs

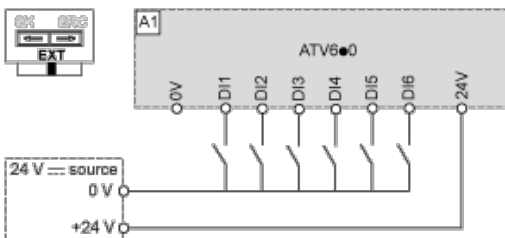

## Derating Curves

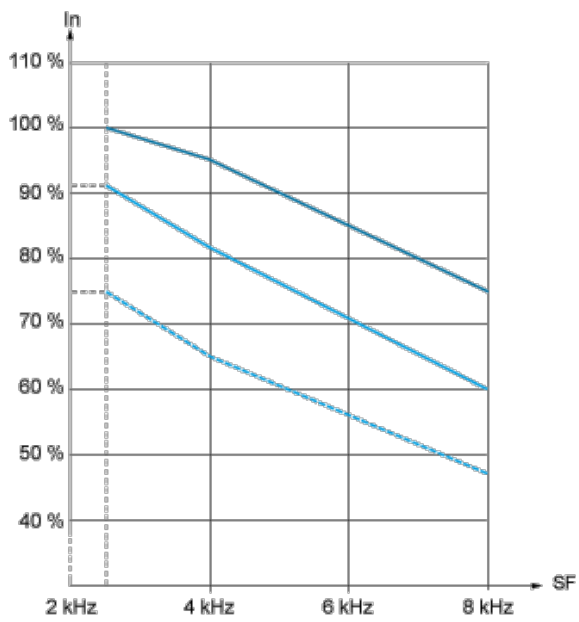

— 40 °C (104 °F)

- - - 50 °C (113 °F)

— 60 °C (140 °F)

In : Nominal Drive Current

SF : Switching Frequency



Компания «ЭлектроПласт» предлагает заключение долгосрочных отношений при поставках импортных электронных компонентов на взаимовыгодных условиях!

Наши преимущества:

- Оперативные поставки широкого спектра электронных компонентов отечественного и импортного производства напрямую от производителей и с крупнейших мировых складов;
- Поставка более 17-ти миллионов наименований электронных компонентов;
- Поставка сложных, дефицитных, либо снятых с производства позиций;
- Оперативные сроки поставки под заказ (от 5 рабочих дней);
- Экспресс доставка в любую точку России;
- Техническая поддержка проекта, помощь в подборе аналогов, поставка прототипов;
- Система менеджмента качества сертифицирована по Международному стандарту ISO 9001;
- Лицензия ФСБ на осуществление работ с использованием сведений, составляющих государственную тайну;
- Поставка специализированных компонентов (Xilinx, Altera, Analog Devices, Intersil, Interpoint, Microsemi, Aeroflex, Peregrine, Syfer, Eurofarad, Texas Instrument, Miteq, Cobham, E2V, MA-COM, Hittite, Mini-Circuits, General Dynamics и др.);

Помимо этого, одним из направлений компании «ЭлектроПласт» является направление «Источники питания». Мы предлагаем Вам помощь Конструкторского отдела:

- Подбор оптимального решения, техническое обоснование при выборе компонента;
- Подбор аналогов;
- Консультации по применению компонента;
- Поставка образцов и прототипов;
- Техническая поддержка проекта;
- Защита от снятия компонента с производства.



#### Как с нами связаться

**Телефон:** 8 (812) 309 58 32 (многоканальный)

**Факс:** 8 (812) 320-02-42

**Электронная почта:** [org@eplast1.ru](mailto:org@eplast1.ru)

**Адрес:** 198099, г. Санкт-Петербург, ул. Калинина, дом 2, корпус 4, литера А.