

SR 30 SERIES CONNECTORS

Introduction

SR30 series circular connectors are developed for use in the microphone circuitry of compact size wireless communication equipment. Its size is remarkably miniaturized

compared with conventional connectors, offering an attractive contemporary design.

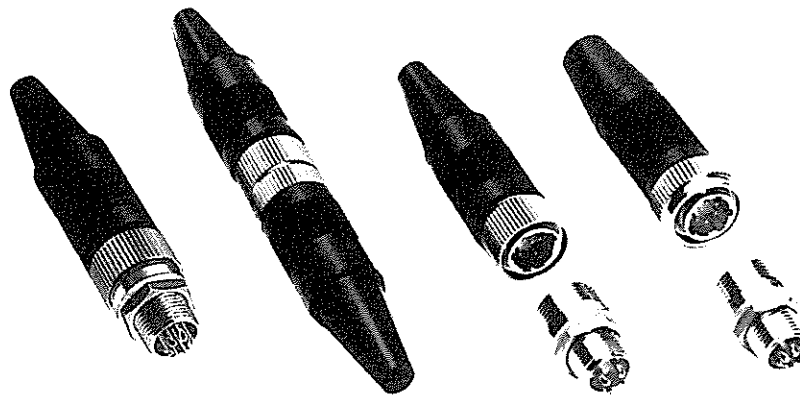

Features

- (1) Compact and light weight maximum outside diameter of $\phi 15$ mm.
- (2) Most suitable for compact electronic devices such as high grade transceivers, ITV cameras, and radio equipment.
- (3) Streamlined design well suited for compact devices.
- (4) Bushings are provided for the cable ends to prevent damage from bending.

Main Specification

Description	Test data
Withstanding voltage	AC 300V for 1 min.
Current capacity	1A
Insulation resistance	200M Ω and more at DC 100V
Contact resistance	10m Ω or less at DC 1A

Part	Material	Finish
Shell	Brass and Zinc alloy	Nickel plated and Chromium plated
Insulator	Polyacetal resin	Glass filled
Male pin	Brass	Gold plated or Silver plated
Female pin	Copper alloy	Gold plated or Silver plated

Plug

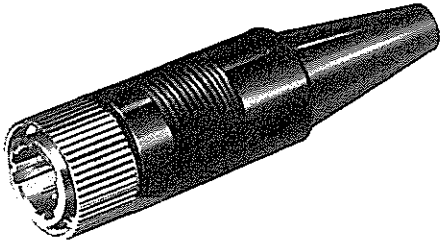

SR30-10PE-6P (74)

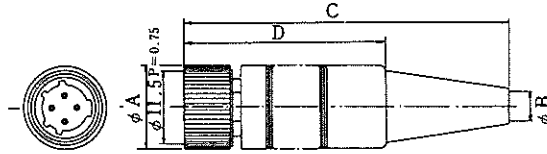

(An example in shape)

- Note 1) When ordering the SR30-10PE-6P or SR30-10PX-6P, order SR30-P cable clamps separately, because such plugs have no cable clamps.
 Note 2) The inside diameter of the male terminal solder post inside diameter is 0.8 mm.

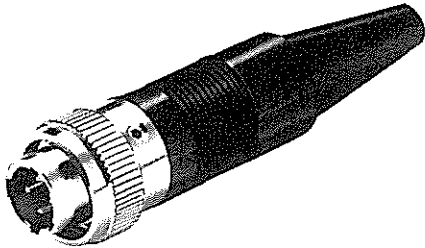

SR30-10PQ-4P (71)

HRS No.	Part No.	No. of pin	φ A	φ B	C	D	Remarks	RoHS	
103-0265-2-71	SR30-10PE-4P (71)	4	13	4.3	51.5	32	-	○	
103-0258-7-74	SR30-10PE-6P (74)	6	13	4.3	51.5	32	Note 1		
103-0273-0-71	SR30-10PG-6P (71)	6	13	5.2	49.0	31	-		
103-0336-9-71	SR30-10PX-6P (71)	6	13	5.7	49.0	-	Note 1		
103-0319-0-71	SR30-10PF-6P (71)	6	15	5.5	55.0	-	-		
103-0316-1-71	SR30-10PF-7P (71)	7	15	5.5	55.0	-	Silver plated		
103-0341-9-71	SR30-10PM-4P (71)	4	15	5.7	49.0	-	-		
103-0288-8-71	SR30-10PM-6P (71)	6	15	5.7	49.0	-	-		
103-0293-8-71	SR30-10PQ-4P (71)	4	15	4.3	57.5	38	Screw attached		
103-0313-3-71	SR30-10PQ-6P (71)	6	15	4.3	57.5	38	Screw attached		
103-0350-0-71	SR30-10WP-6PA (71)	6	15	4.3	51.5	32	Waterproof		
103-0362-9-71	SR30-10WPA-7P (71)	7	15	5.5	109	-	Waterproof		
103-0266-5	SR30-P						Metal clammer		-

Receptacle (Jam Nut to be fastened)

Solder Type

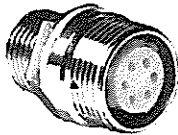

SR30-10R-6S (71)

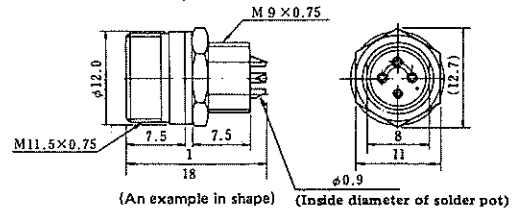

- Note 1: Some dimensions of the waterproof types different from those given below.

HRS No.	Part No.	No. of pin	Remarks	RoHS
103-0264-0-71	SR30-10R-4S (71)	4	-	○
103-0239-2-71	SR30-10R-6S (71)	6	-	
103-0317-4-71	SR30-10R-7S (71)	7	Silver plated	
103-0349-0-71	SR30-10WR-6SA (71)	6	Waterproof	

Remark: Use mounting panels 5 mm or less in thickness.

Dip Type

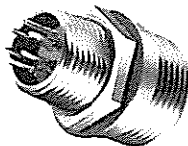

SR30-10RA-6SE (72)

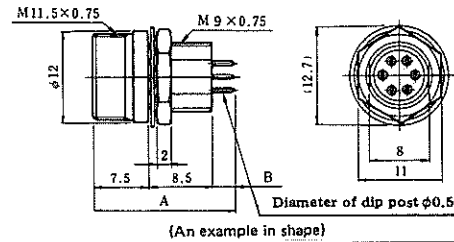

HRS No.	Part No.	No. of pin	A	B	Remarks	RoHS
103-0356-6-71	SR30-10RA-4SE (71)	4	19	3	Silver plated	○
103-0326-5-72	SR30-10RA-6SE (72)	6	19	3	-	
103-0327-8-71	SR30-10RA-7SE (71)	7	19	3	Silver plated	
103-0361-6-71	SR30-10WR-7SE (71)	7	19	3	Waterproof	

Remark: Use mounting panels 5 mm or less in thickness.

Receptacle (Jam Nut to be fastened from front panel)

(Solder Type)

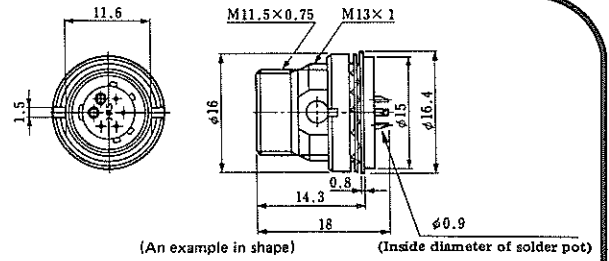
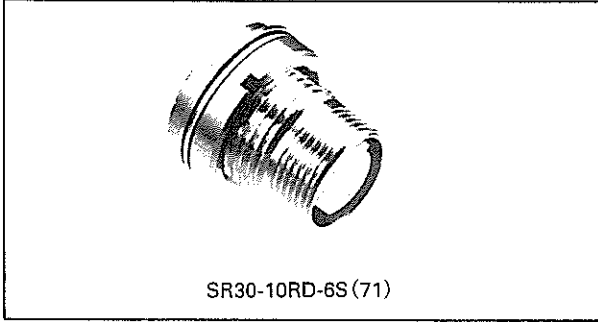

HRS No.	Part No.	No. of pins	RoHS
103-0302-7-71	SR30-10RD-6S(71)	6	○

Remark: Use mounting panel 3 mm or less in thickness.

Jack

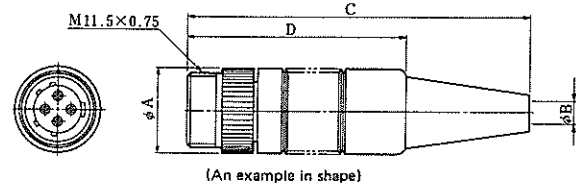
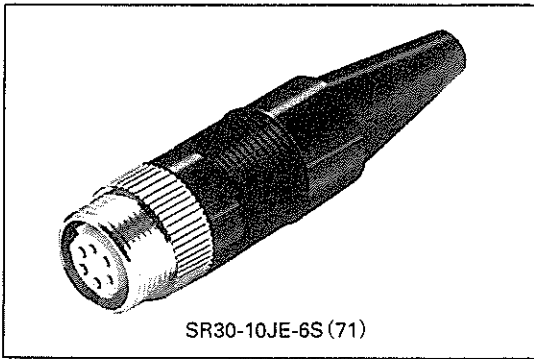

Note 1) When ordering the SR30-10JE-6S receptacles, order SR30-P cable clamps (CL103-0266-5) separately, because they have no cable clamps.

Note 2) The inside diameter of the male terminal solder pot is 0.9 mm.

HRS No.	Part No.	No. of pins	phi A	phi B	C	D	Remarks	RoHS
103-0301-4-71	SR30-10JE-4S(71)	4	13	4.3	53.5	34	-	○
103-0259-0-72	SR30-10JE-6S(72)	6	13	4.3	53.5	34	Note1)	
103-0292-5-71	SR30-10JM-6S(71)	6	13	5.7	51	-	-	
103-0330-2-71	SR30-10JF-7S(71)	7	13	5.5	57	-	Silver plated	

Cap

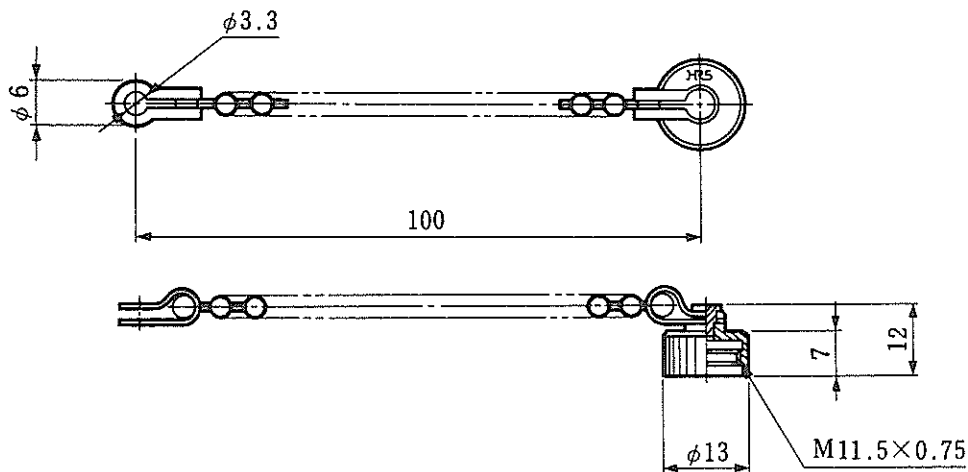

HRS No.	Part No.	Remarks	RoHS
103-0344-7-71	SR30-10RC1(71)	-	○

PCB Layout

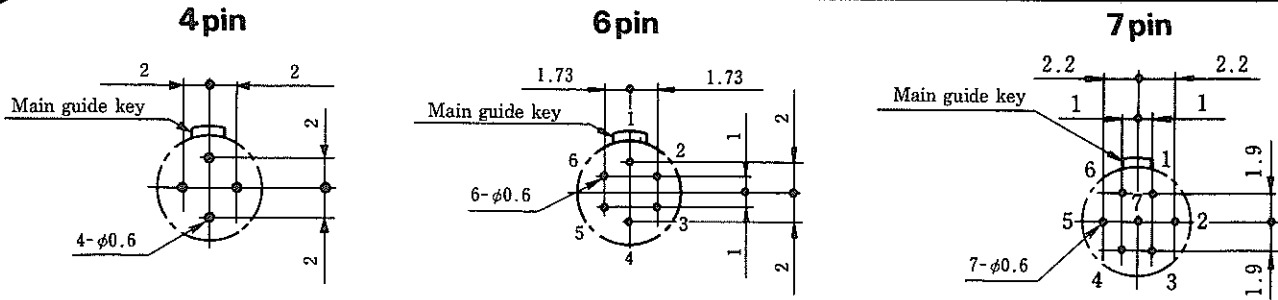

- Remarks
1. The figures show the views from the mating side.
 2. Dimensional tolerance of dip post arrangement is recommended ± 0.05 .
 3. A hole diameter of 0.9 mm is recommended for the SR30-10RA-6SF(01).

Assembling Procedure

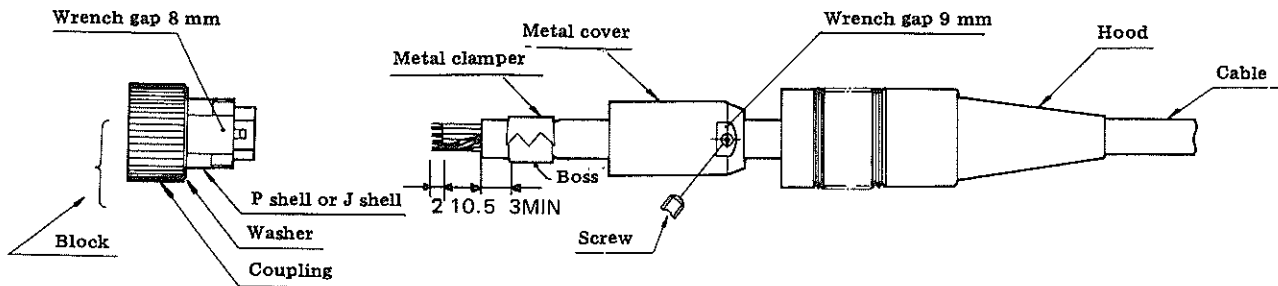

1. Use a cable of 4.2 – 4.8 m/m, for SR30-10PE-4P and SR30-10PE-6P, or 5.5 – 6.2 m/m, for SR30-10PM-6P, in the outer diameter and 0.3 m/m² in nominal conductor cross-sectional area.
2. Pass the cable through a hood and a metal cover. Cut off the end of the cable with dimensions as shown.
3. Insert an assembling tool into the block and terminate the cable by soldering.
4. Stake a metal clammer, SR30-P, to the cable several times by means of a crimping tool, SR30-10PE-T, in such a way that the outer diameter becomes about 5.2 m/m.
5. And then, fasten the metal cover into the thread section of plug shell by means of a single-acting torque wrench.
6. Thrust a screw into one of two bosses of the metal clammer in such a way that the tip of screw sinks.
7. Put a hood on the metal cover.

Tools

Clamping Tool

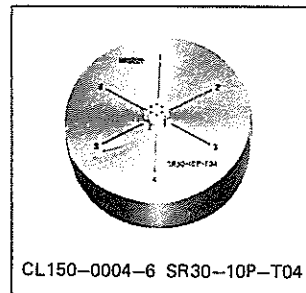
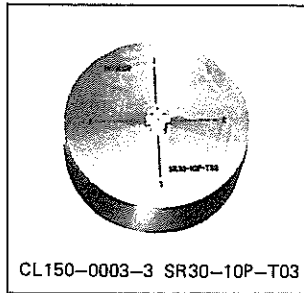

Soldering and Fastening Tool

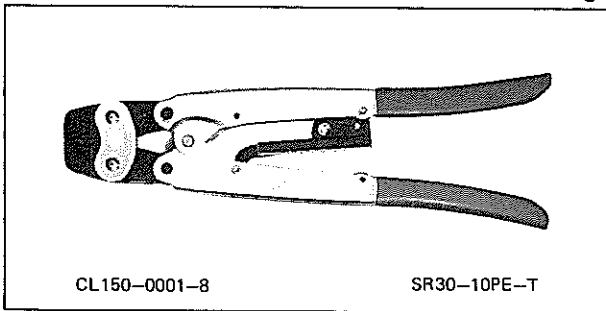

Applicable Cable dia. $\phi 4.2 \sim \phi 4.8$

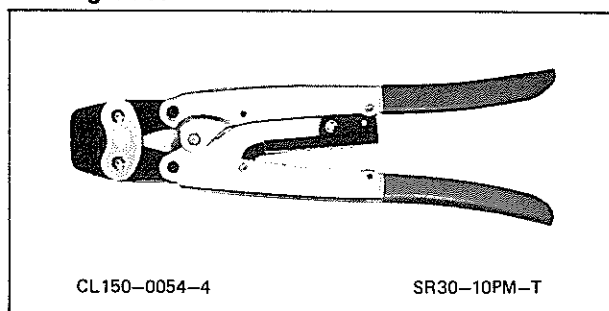

Applicable Cable dia. $\phi 6$



Компания «ЭлектроПласт» предлагает заключение долгосрочных отношений при поставках импортных электронных компонентов на взаимовыгодных условиях!

Наши преимущества:

- Оперативные поставки широкого спектра электронных компонентов отечественного и импортного производства напрямую от производителей и с крупнейших мировых складов;
- Поставка более 17-ти миллионов наименований электронных компонентов;
- Поставка сложных, дефицитных, либо снятых с производства позиций;
- Оперативные сроки поставки под заказ (от 5 рабочих дней);
- Экспресс доставка в любую точку России;
- Техническая поддержка проекта, помощь в подборе аналогов, поставка прототипов;
- Система менеджмента качества сертифицирована по Международному стандарту ISO 9001;
- Лицензия ФСБ на осуществление работ с использованием сведений, составляющих государственную тайну;
- Поставка специализированных компонентов (Xilinx, Altera, Analog Devices, Intersil, Interpoint, Microsemi, Aeroflex, Peregrine, Syfer, Eurofarad, Texas Instrument, Miteq, Cobham, E2V, MA-COM, Hittite, Mini-Circuits, General Dynamics и др.);

Помимо этого, одним из направлений компании «ЭлектроПласт» является направление «Источники питания». Мы предлагаем Вам помощь Конструкторского отдела:

- Подбор оптимального решения, техническое обоснование при выборе компонента;
- Подбор аналогов;
- Консультации по применению компонента;
- Поставка образцов и прототипов;
- Техническая поддержка проекта;
- Защита от снятия компонента с производства.



Как с нами связаться

Телефон: 8 (812) 309 58 32 (многоканальный)

Факс: 8 (812) 320-02-42

Электронная почта: org@eplast1.ru

Адрес: 198099, г. Санкт-Петербург, ул. Калинина, дом 2, корпус 4, литера А.