

SURFACE MOUNT GPP
TRANSIENT VOLTAGE SUPPRESSOR
600 WATT PEAK POWER 5.0 WATTS STEADY STATE

FEATURES

- * Plastic package has underwriters laboratory
- * Glass passivated chip construction
- * 600 watt surge capability at 1ms
- * Excellent clamping capability
- * Low zener impedance
- * Fast response time

Ratings at 25 °C ambient temperature unless otherwise specified.

MAXIMUM RATINGS AND ELECTRICAL CHARACTERISTICS

Ratings at 25 °C ambient temperature unless otherwise specified.



DO-214AA

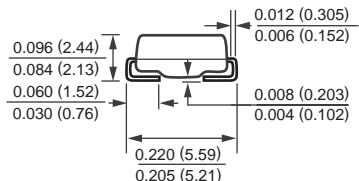
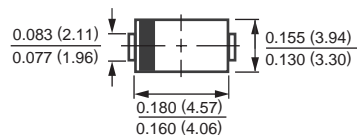

Dimensions in inches and (millimeters)

DEVICES FOR BIPOLAR APPLICATIONS

For Bidirectional use C or CA suffix for types P6FMBJ6.8 thru P6FMBJ400

Electrical characteristics apply in both direction

MAXIMUM RATINGS (At TA = 25°C unless otherwise noted)

RATINGS	SYMBOL	VALUE	UNITS
Peak Power Dissipation with a 10/1000uS (Note 1,2 Fig.1)	PPPM	Minimum 600	Watts
Peak Pulse Durrent with a 10/1000uS waveform (Note 1, Fig.3)	IPPM	SEE TABLE 1	Amps
Steady State Power Dissipation at TL = 75°C (Note 2)	PM(AV)	5.0	Watts
Peak Forward Surge Current, 8.3mS single half sine wave super-imposed on rated load (Jedec Method)(Note 3,2) unidirectional only	IFSM	100	Amps
Maximum Instantaneous Forward Voltage at 50A for unidirectional only (Note 3,4)	VF	SEE NOTE 4	Volts
Operating and Storage Temperature Range	TJ, TSTG	-55 to + 150	°C

NOTES : 1. Non-repetitive current pulse, per Fig.3 and derated above TA = 25°C per Fig.2.

2. Mounted on 0.2 X 0.2" (5.0 X 5.0mm) copper pad to each terminal.

3. Measured on 8.3mS single half Sine-Wave or equivalent wave, duty cycle = 4 pulses per minute maximum.

4. VF = 3.5V on P6FMBJ6.8 thru P6FMB90 devices and VF = 5.0V on P6FMBJ100 thur P6FMBJ400 devices.

RATING AND CHARACTERISTIC CURVES (P6FMBJ6.8 THRU P6FMBJ400CA)

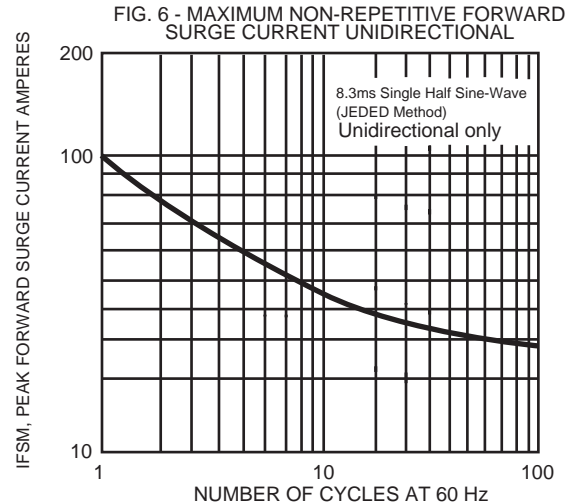
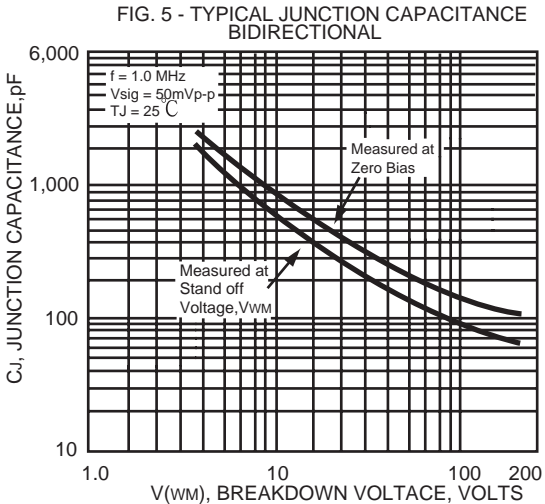
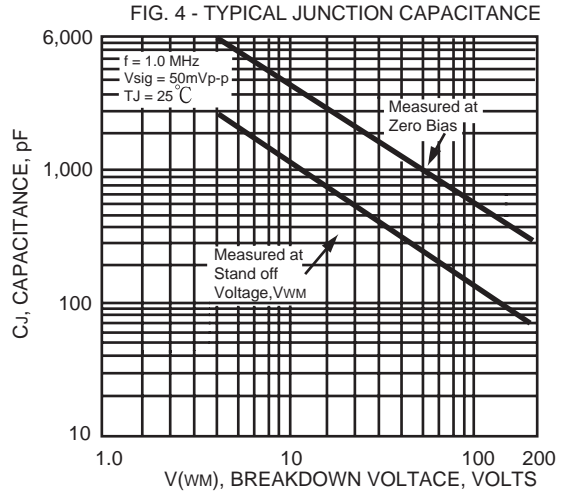
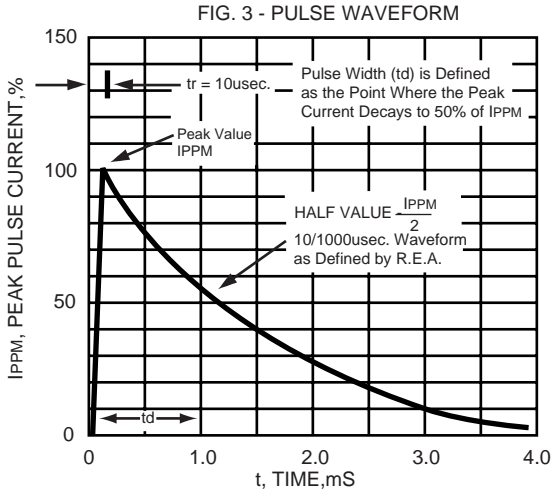
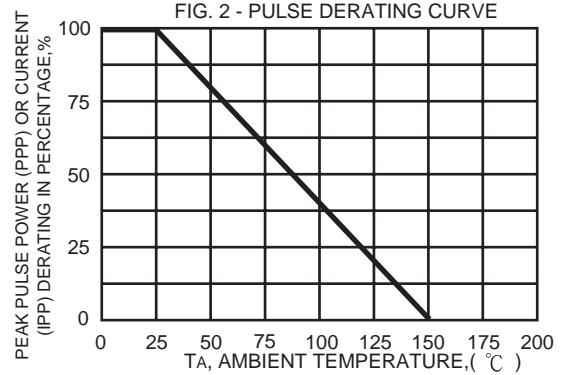
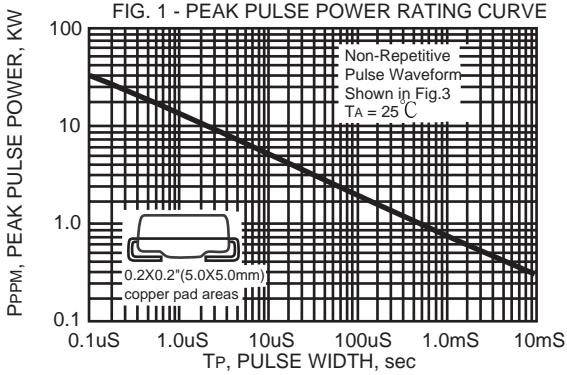

TRANSIENT VOLTAGE SUPPRESSORS

600W SERIES TVS DIODES / DO-214AA (CASE 3) 600W

TYPE	Breakdown Voltage			Reverse Stand off Voltage V_{WM} (Volts)	Maximum Reverse Leakage at V_{WM} I_D (μ A)	Maximum Peak Pulse Current I_{PPM} (Amps)	Maximum Clamping Voltage at I_{PPM} V_C (Volts)
	V_{BR} (Volts)		@ I_T (mA)				
	MIN.	MAX.					
P6FMBJ6.8	6.12	7.48	10	5.50	1000	55.6	10.8
P6FMBJ6.8A	6.45	7.14	10	5.80	1000	57.1	10.5
P6FMBJ7.5	6.75	8.25	10	6.05	500	51.3	11.7
P6FMBJ7.5A	7.13	7.88	10	6.40	500	53.1	11.3
P6FMBJ8.2	7.38	9.02	10	6.63	200	48	12.5
P6FMBJ8.2A	7.79	8.61	10	7.02	200	49.6	12.1
P6FMBJ9.1	8.19	10.0	1.0	7.37	50	43.5	13.8
P6FMBJ9.1A	8.65	9.55	1.0	7.78	50	44.8	13.4
P6FMBJ10	9.00	11.0	1.0	8.10	10	40	15.0
P6FMBJ10A	9.50	10.5	1.0	8.55	10	41.4	14.5
P6FMBJ11	9.90	12.1	1.0	8.92	5.0	37	16.2
P6FMBJ11A	10.5	11.6	1.0	9.40	5.0	38.5	15.6
P6FMBJ12	10.8	13.2	1.0	9.72	5.0	34.7	17.3
P6FMBJ12A	11.4	12.6	1.0	10.2	5.0	35.9	16.7
P6FMBJ13	11.7	14.3	1.0	10.5	5.0	31.6	19.0
P6FMBJ13A	12.4	13.7	1.0	11.1	5.0	33	18.2
P6FMBJ15	13.5	16.5	1.0	12.1	5.0	27.3	22.0
P6FMBJ15A	14.3	15.8	1.0	12.8	5.0	28.3	21.2
P6FMBJ16	14.4	17.6	1.0	12.9	5.0	25.5	23.5
P6FMBJ16A	15.2	16.8	1.0	13.6	5.0	26.7	22.5
P6FMBJ18	16.2	19.8	1.0	14.5	5.0	22.6	26.5
P6FMBJ18A	17.1	18.9	1.0	15.3	5.0	23.8	25.2
P6FMBJ20	18.0	22.0	1.0	16.2	5.0	20.6	29.1
P6FMBJ20A	19.0	21.0	1.0	17.1	5.0	21.7	27.7
P6FMBJ22	19.8	24.2	1.0	17.8	5.0	18.8	31.9
P6FMBJ22A	20.9	23.1	1.0	18.8	5.0	19.6	30.6
P6FMBJ24	21.6	26.4	1.0	19.4	5.0	17.3	34.7
P6FMBJ24A	22.8	25.2	1.0	20.5	5.0	18.1	33.2
P6FMBJ27	24.3	29.7	1.0	21.8	5.0	15.3	39.1
P6FMBJ27A	25.7	28.4	1.0	23.1	5.0	16	37.5
P6FMBJ30	27.0	33.0	1.0	24.3	5.0	13.8	43.5
P6FMBJ30A	28.5	31.5	1.0	25.6	5.0	14.5	41.4
P6FMBJ33	29.7	36.3	1.0	26.8	5.0	12.6	47.7
P6FMBJ33A	31.4	34.7	1.0	28.2	5.0	13.1	45.7
P6FMBJ36	32.4	39.6	1.0	29.1	5.0	11.5	52.0
P6FMBJ36A	34.2	37.8	1.0	30.8	5.0	12	49.9
P6FMBJ39	35.1	42.9	1.0	31.6	5.0	10.6	56.4
P6FMBJ39A	37.1	41.0	1.0	33.3	5.0	11.1	53.9
P6FMBJ43	38.7	47.3	1.0	34.8	5.0	9.7	61.9
P6FMBJ43A	40.9	45.2	1.0	36.8	5.0	10.1	59.3
P6FMBJ47	42.3	51.7	1.0	38.1	5.0	8.8	67.8
P6FMBJ47A	44.7	49.4	1.0	40.2	5.0	9.3	64.8
P6FMBJ51	45.9	56.1	1.0	41.3	5.0	8.2	73.5
P6FMBJ51A	48.5	53.6	1.0	43.6	5.0	8.6	70.1
P6FMBJ56	50.4	61.6	1.0	45.4	5.0	7.5	80.5
P6FMBJ56A	53.2	58.8	1.0	47.8	5.0	7.8	77.0

TRANSIENT VOLTAGE SUPPRESSORS

600W SERIES TVS DIODES / DO-214AA (CASE 3) 600W

TYPE	Breakdown Voltage			Reverse Stand off Voltage V_{WM} (Volts)	Maximum Reverse Leakage at V_{WM} I_D (μ A)	Maximum Peak Pulse Current I_{PPM} (Amps)	Maximum Clamping Voltage at I_{PPM} V_C (Volts)
	V_{BR} (Volts)		@ I_T (mA)				
	MIN.	MAX.					
P6FMBJ62	55.8	68.2	1.0	50.2	5.0	7.0	89.0
P6FMBJ62A	58.9	65.1	1.0	53.0	5.0	7.4	85.0
P6FMBJ68	61.2	74.8	1.0	55.1	5.0	6.4	98.0
P6FMBJ68A	64.6	71.4	1.0	58.1	5.0	6.8	92.0
P6FMBJ75	67.5	82.5	1.0	60.7	5.0	5.8	108
P6FMBJ75A	71.3	78.8	1.0	64.1	5.0	6.1	103
P6FMBJ82	73.8	90.2	1.0	66.4	5.0	5.3	118
P6FMBJ82A	77.9	86.1	1.0	70.1	5.0	5.5	113
P6FMBJ91	81.9	100	1.0	73.7	5.0	4.8	131
P6FMBJ91A	86.5	95.5	1.0	77.8	5.0	5.0	125
*P6FMBJ100	90.0	110	1.0	81.0	5.0	3.5	144
*P6FMBJ100A	95.0	105	1.0	85.5	5.0	3.6	137
*P6FMBJ110	99.0	121	1.0	89.2	5.0	3.2	158
*P6FMBJ110A	105	116	1.0	94.0	5.0	3.3	152
*P6FMBJ120	108	132	1.0	97.2	5.0	2.9	173
*P6FMBJ120A	114	126	1.0	102	5.0	3.0	165
*P6FMBJ130	117	143	1.0	105	5.0	2.7	187
*P6FMBJ130A	124	137	1.0	111	5.0	2.8	179
*P6FMBJ150	135	165	1.0	121	5.0	2.3	215
*P6FMBJ150A	143	158	1.0	128	5.0	2.4	207
*P6FMBJ160	144	176	1.0	130	5.0	2.2	230
*P6FMBJ160A	152	168	1.0	136	5.0	2.3	219
*P6FMBJ170	153	187	1.0	138	5.0	2.0	244
*P6FMBJ170A	162	179	1.0	145	5.0	2.1	234
*P6FMBJ180	162	198	1.0	146	5.0	1.9	258
*P6FMBJ180A	171	189	1.0	154	5.0	2.0	246
*P6FMBJ200	180	220	1.0	162	5.0	1.7	287
*P6FMBJ200A	190	210	1.0	171	5.0	1.8	274
*P6FMBJ220	198	242	1.0	175	5.0	1.5	344
*P6FMBJ220A	209	231	1.0	185	5.0	1.6	328
*P6FMBJ250	225	275	1.0	202	5.0	1.4	360
*P6FMBJ250A	237	263	1.0	214	5.0	1.5	344
*P6FMBJ300	270	330	1.0	243	5.0	1.2	430
*P6FMBJ300A	285	315	1.0	256	5.0	1.3	414
*P6FMBJ350	315	385	1.0	284	5.0	1.0	504
*P6FMBJ350A	332	368	1.0	300	5.0	1.1	482
*P6FMBJ400	360	440	1.0	324	5.0	0.8	574
*P6FMBJ400A	380	420	1.0	342	5.0	0.9	548

- Notes :
1. V_{BR} measured after I_T applied for 300ms. I_T = square pulse or equivalent.
 2. For bidirectional use C or CA suffixs for all types (ex. P6FMBJ6.8C,P6FMBJ400CA) electrical characteristics apply in both directions.
 3. For bidirectional types having V_{WM} of 10 volts and less, the I_D limit is doubled.
 4. All devices UL listed file# E211196.
 5. Mark "*" reverse power rating are 500W .

Mounting Pad Layout

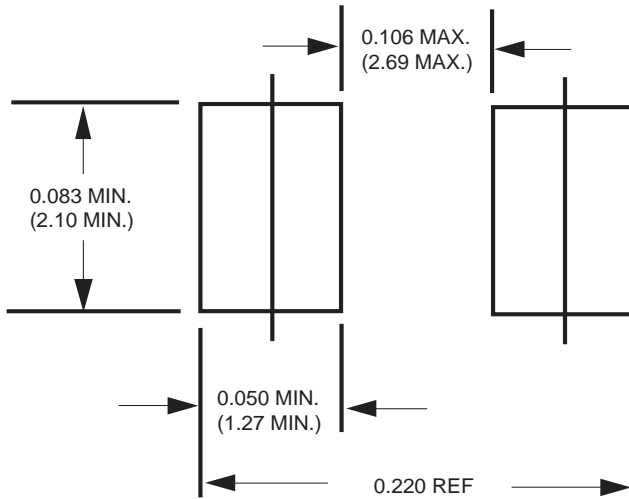

Dimensions in inches and (millimeters)



Компания «ЭлектроПласт» предлагает заключение долгосрочных отношений при поставках импортных электронных компонентов на взаимовыгодных условиях!

Наши преимущества:

- Оперативные поставки широкого спектра электронных компонентов отечественного и импортного производства напрямую от производителей и с крупнейших мировых складов;
- Поставка более 17-ти миллионов наименований электронных компонентов;
- Поставка сложных, дефицитных, либо снятых с производства позиций;
- Оперативные сроки поставки под заказ (от 5 рабочих дней);
- Экспресс доставка в любую точку России;
- Техническая поддержка проекта, помощь в подборе аналогов, поставка прототипов;
- Система менеджмента качества сертифицирована по Международному стандарту ISO 9001;
- Лицензия ФСБ на осуществление работ с использованием сведений, составляющих государственную тайну;
- Поставка специализированных компонентов (Xilinx, Altera, Analog Devices, Intersil, Interpoint, Microsemi, Aeroflex, Peregrine, Syfer, Eurofarad, Texas Instrument, Miteq, Cobham, E2V, MA-COM, Hittite, Mini-Circuits, General Dynamics и др.);

Помимо этого, одним из направлений компании «ЭлектроПласт» является направление «Источники питания». Мы предлагаем Вам помощь Конструкторского отдела:

- Подбор оптимального решения, техническое обоснование при выборе компонента;
- Подбор аналогов;
- Консультации по применению компонента;
- Поставка образцов и прототипов;
- Техническая поддержка проекта;
- Защита от снятия компонента с производства.



Как с нами связаться

Телефон: 8 (812) 309 58 32 (многоканальный)

Факс: 8 (812) 320-02-42

Электронная почта: org@eplast1.ru

Адрес: 198099, г. Санкт-Петербург, ул. Калинина, дом 2, корпус 4, литера А.