



Driver or Pre-driver Amplifier for Doherty Power Amplifiers

The MMG30301B is a 1 W high gain amplifier designed as a driver or pre-driver for Doherty power amplifiers in wireless infrastructure equipment operating in the 900 to 4300 MHz frequency range. Because of its versatile design, the device may also be used in a variety of general purpose amplifier applications, including those at frequencies from 900 to 4300 MHz.

Features

- P1dB: 30.1 dBm @ 2140 MHz
- Gain: 16.2 dB @ 2140 MHz
- Designed as a Doherty PA driver or pre-driver
- 5 V single supply, 258 mA current
- SOT-89 package
- 50 ohm operation with minimal external matching

MMG30301BT1

**900–4300 MHz, 16.2 dB @ 2140 MHz
30.1 dBm
BTS DRIVER AMPLIFIER**



SOT-89

Table 1. Load Pull Performance (1)

Characteristic	Symbol	900 MHz	1900 MHz	2140 MHz	2600 MHz	3350 MHz	Unit
Maximum Available Gain	MAG	24.1	17.9	16.9	15.2	13.3	dB
P _{out} @ 1dB Compression	P1dB	30.0 (2)	30.0 (2)	30.1	30.4	30.1	dBm

Table 2. Maximum Ratings

Rating	Symbol	Value	Unit
Supply Voltage	V _{CC}	6	V
Supply Current	I _{CC}	480	mA
RF Input Power	P _{in}	23	dBm
Storage Temperature Range	T _{stg}	-65 to +150	°C
Junction Temperature	T _J	175	°C

Table 3. Thermal Characteristics

Characteristic	Symbol	Value (3)	Unit
Thermal Resistance, Junction to Case Case Temperature 91°C, 5 Vdc, 280 mA, no RF applied	R _{θJC}	17	°C/W

1. V_{CC} = 5 Vdc, T_A = 25°C, CW.

2. Maximum allowable current not to exceed 480 mA.

3. Refer to AN1955, *Thermal Measurement Methodology of RF Power Amplifiers*. Go to <http://www.nxp.com/RF> and search for AN1955.

Table 4. Electrical Characteristics ($V_{CC} = 5$ Vdc, 2140 MHz, $T_A = 25^\circ\text{C}$, 50 ohm system, in NXP Application Circuit)

Characteristic	Symbol	Min	Typ	Max	Unit
Small-Signal Gain (S21)	G_p	15.8	16.2	—	dB
Power Output @ 1dB Compression	P1dB	—	30.1	—	dBm
Input Return Loss (S11)	IRL	—	-11.8	—	dB
Output Return Loss (S22)	ORL	—	-13.8	—	dB
Noise Figure	NF	—	3.7	—	dB
Supply Current	I_{CC}	240	258	280	mA
Supply Voltage	V_{CC}	—	5	—	V

Table 5. Functional Pin Description

Pin Number	Pin Function
1	RF _{in}
2	Ground
3	RF _{out} /DC Supply

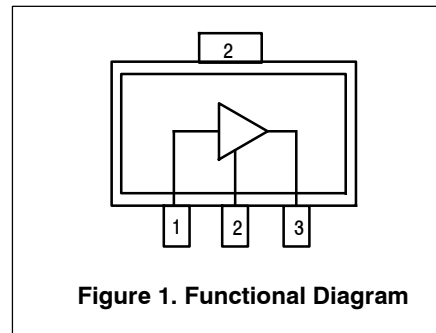
**Table 6. ESD Protection Characteristics**

Test Methodology	Class
Human Body Model (per JESD 22-A114)	1B
Charge Device Model (per JESD 22-C101)	C3

Table 7. Moisture Sensitivity Level

Test Methodology	Rating	Package Peak Temperature	Unit
Per JESD22-A113, IPC/JEDEC J-STD-020	1	260	$^\circ\text{C}$

Table 8. Ordering Information

Device	Tape and Reel Information	Package
MMG30301BT1	T1 Suffix = 1,000 Units, 12 mm Tape Width, 7-inch Reel	SOT-89

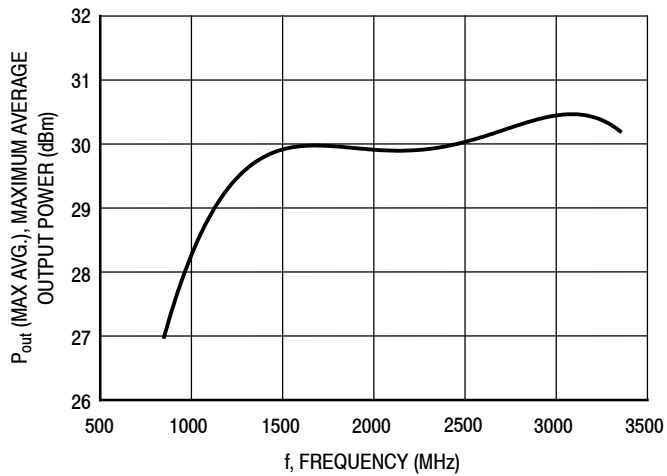

Note: Maximum allowable current not to exceed 480 mA.

Figure 2. Maximum Average Output Power versus Frequency

Table 9. ACPR versus Frequency (LTE 10 MHz, ACPR = -48 dBc)

f (MHz)	ACPR = -48 dBc		
	P _{out} (dBm)	Gain (dB)	I _{cc} (mA)
2140	20.5	16.5	300
2600	19.2	14.4	278
3500	19.3	12.7	262
4150	20.7	10.7	265

50 OHM APPLICATION CIRCUIT: 2110–2170 MHz, 5 VOLT OPERATION

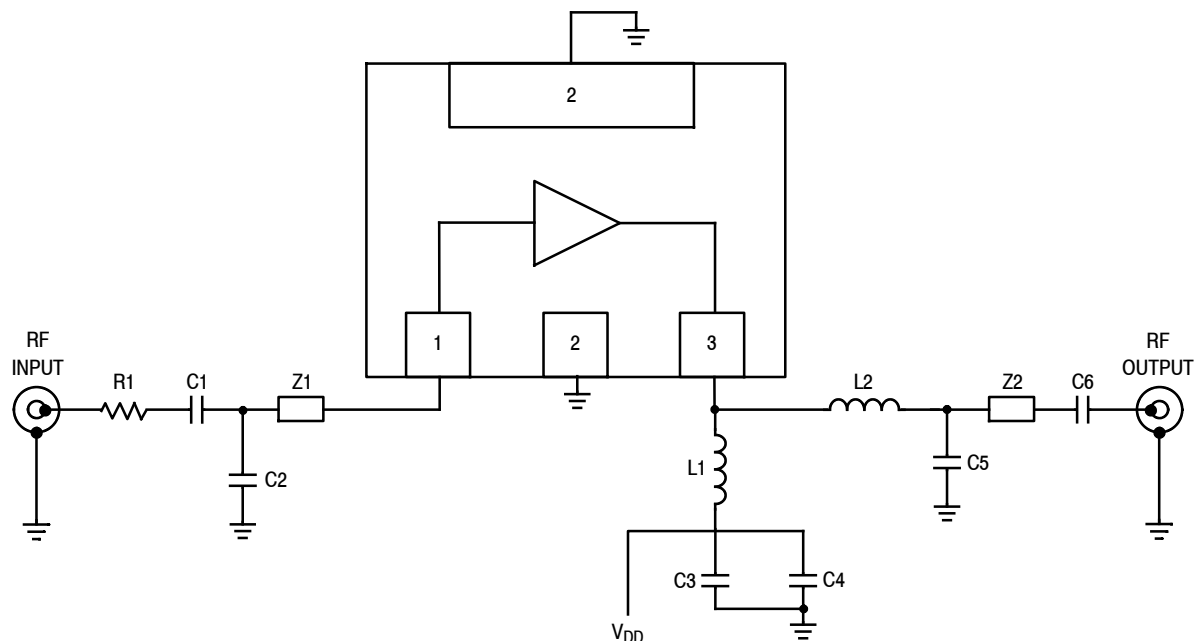

Z1 0.19" × 0.02" Microstrip
 Z2 0.22" × 0.02" Microstrip

Figure 3. MMG30301BT1 Test Circuit Schematic

Table 10. MMG30301BT1 Test Circuit Component Designations and Values

Part	Description	Part Number	Manufacturer
C1	1.5 pF Chip Capacitor	GJM0225C1E1R5WB	Murata
C2	0.5 pF Chip Capacitor	GJM0225C1ER50WB	Murata
C3	0.01 μF Chip Capacitor	GRM188B11E103MA	Murata
C4	1 μF Chip Capacitor	GRM1555C81E105ME	Murata
C5	0.7 pF Chip Capacitor	GJM0225C1ER70WB	Murata
C6	1.1 pF Chip Capacitor	GJM0225C1E1R1WB	Murata
L1	10 nH Chip Inductor	0603CS-10NX	Coilcraft
L2	1 nH Chip Inductor	0402CS-1N0X	Coilcraft
R1	0 Ω, 1 A Chip Resistor	ERJ2GE0R00X	Panasonic
PCB	Rogers R04350B, 0.010", ε _r = 3.66	M128499	MTL

50 OHM APPLICATION CIRCUIT: 2110–2170 MHz, 5 VOLT OPERATION

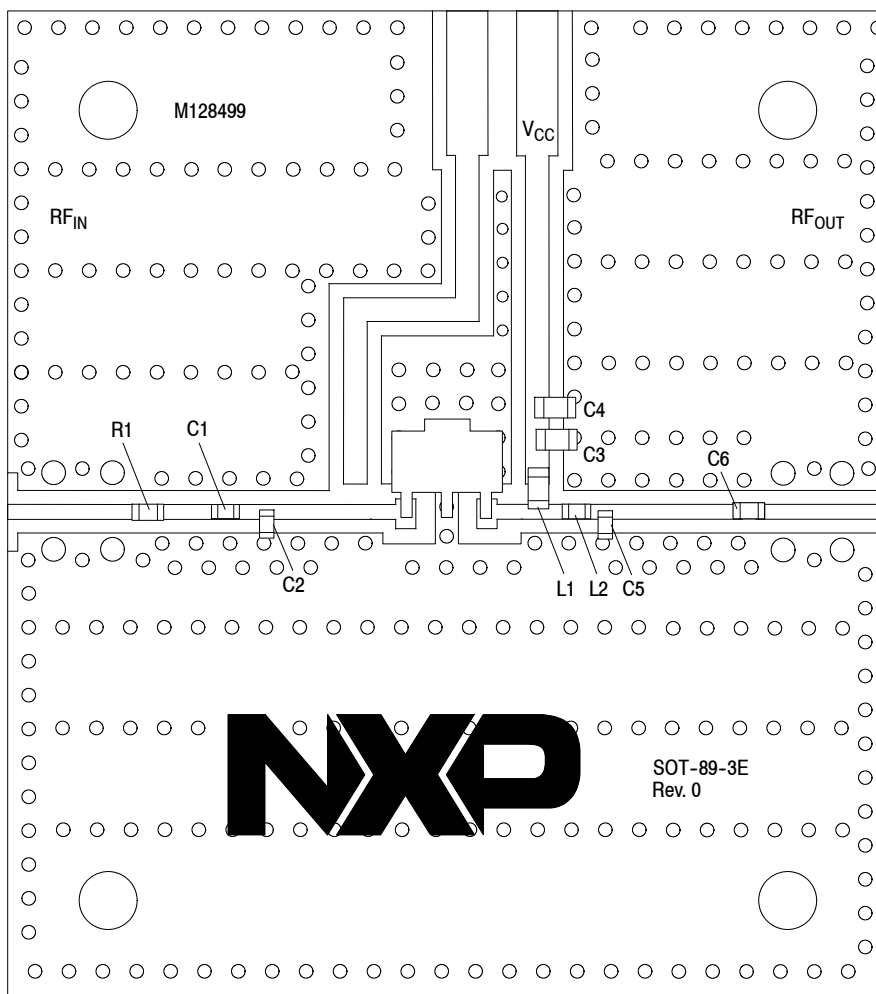

PCB actual size: 1.3" × 1.46".

Figure 4. MMG30301BT1 Test Circuit Component Layout

Table 10. MMG30301BT1 Test Circuit Component Designations and Values

Part	Description	Part Number	Manufacturer
C1	1.5 pF Chip Capacitor	GJM0225C1E1R5WB	Murata
C2	0.5 pF Chip Capacitor	GJM0225C1ER50WB	Murata
C3	0.01 μ F Chip Capacitor	GRM188B11E103MA	Murata
C4	1 μ F Chip Capacitor	GRM1555C81E105ME	Murata
C5	0.7 pF Chip Capacitor	GJM0225C1ER70WB	Murata
C6	1.1 pF Chip Capacitor	GJM0225C1E1R1WB	Murata
L1	10 nH Chip Inductor	0603CS-10NX	Coilcraft
L2	1 nH Chip Inductor	0402CS-1N0X	Coilcraft
R1	0 Ω , 1 A Chip Resistor	ERJ2GE0R00X	Panasonic
PCB	Rogers R04350B, 0.010", $\epsilon_r = 3.66$	M128499	MTL

(Test Circuit Component Designations and Values table repeated for reference.)

50 OHM TYPICAL CHARACTERISTICS: 2110–2170 MHz, 5 VOLT OPERATION

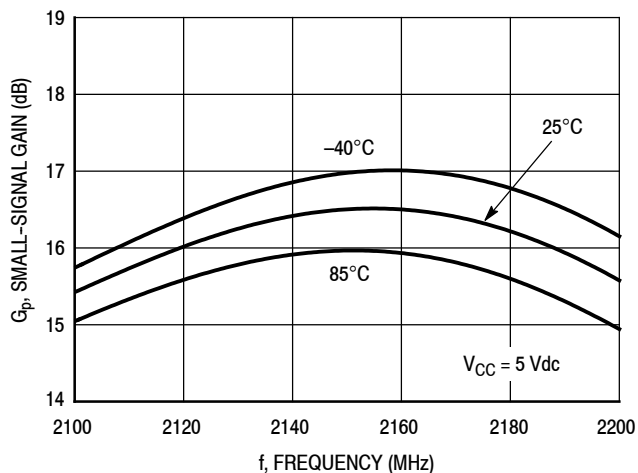

Figure 5. Small-Signal Gain (S21) versus Frequency and Temperature

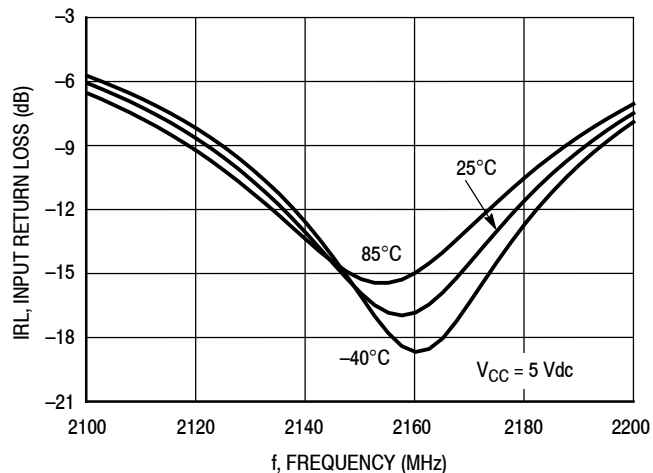

Figure 6. Input Return Loss (S11) versus Frequency and Temperature

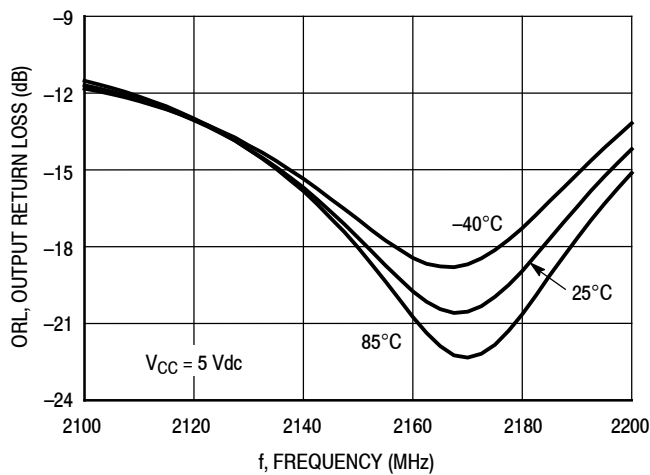

Figure 7. Output Return Loss (S22) versus Frequency and Temperature

50 OHM TYPICAL CHARACTERISTICS: 2110–2170 MHz, 5 VOLT OPERATION

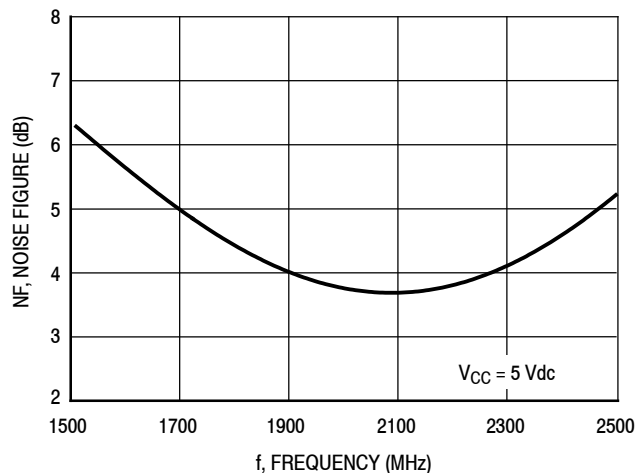

Figure 8. Noise Figure versus Frequency

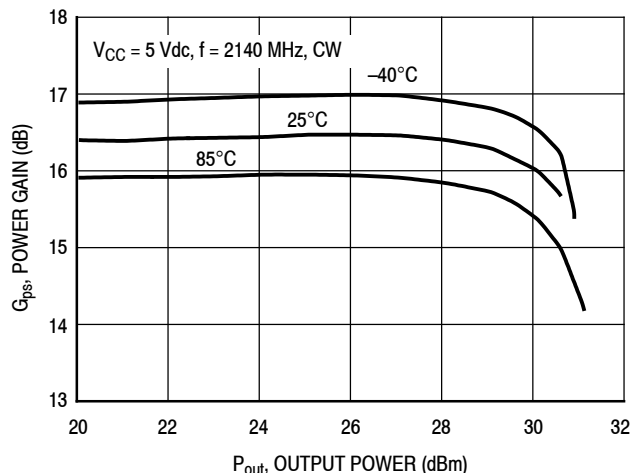

Figure 9. Power Gain versus Output Power and Temperature

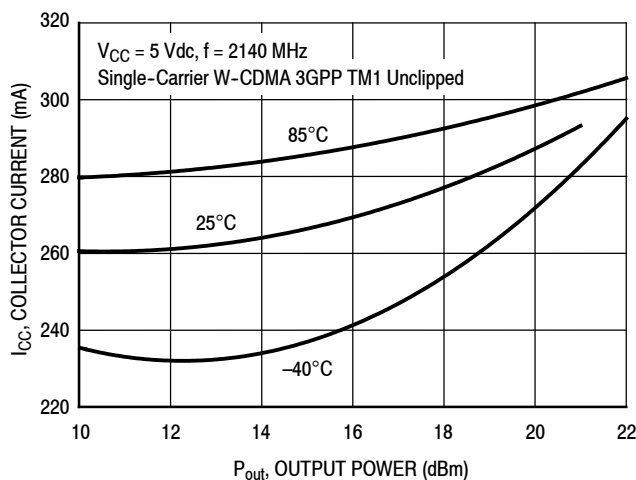

Figure 10. Collector Current versus Output Power and Temperature

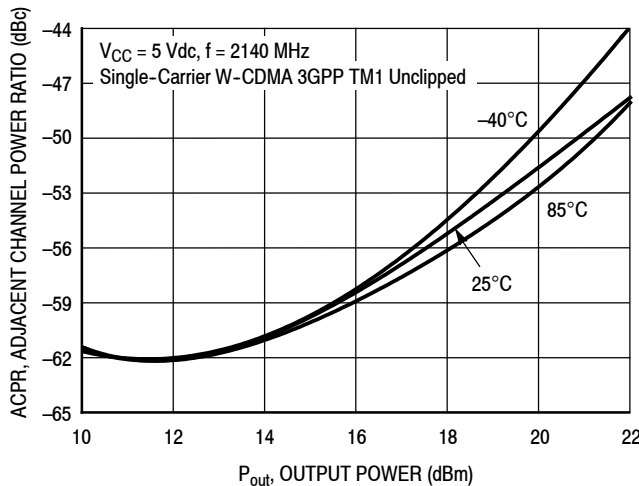
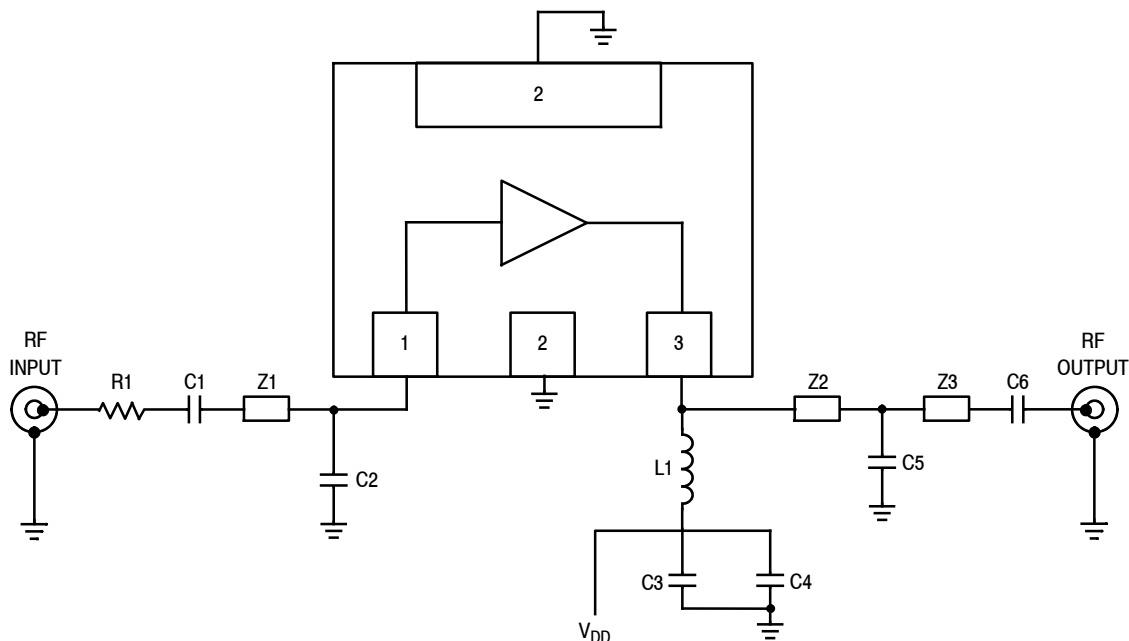

Figure 11. Single-Carrier W-CDMA Adjacent Channel Power Ratio versus Output Power and Temperature

50 OHM APPLICATION CIRCUIT: 1805–1880 MHz, 5 VOLT OPERATION



- Z1 0.115" × 0.02" Microstrip
- Z2 0.18" × 0.02" Microstrip
- Z3 0.2" × 0.02" Microstrip

Figure 12. MMG30301BT1 Test Circuit Schematic

Table 11. MMG30301BT1 Test Circuit Component Designations and Values

Part	Description	Part Number	Manufacturer
C1	1.3 pF Chip Capacitor	GJM0225C1E1R3WB	Murata
C2	3.9 pF Chip Capacitor	GJM0225C1E3R9WB	Murata
C3	1000 pF Chip Capacitor	GCM1555R71E103KA37	Murata
C4	0.1 μF Chip Capacitor	GRM1555R61A104KA01D	Murata
C5	3.3 pF Chip Capacitor	GJM0225C1E3R3WB	Murata
C6	100 pF Chip Capacitor	GRM1555C1H101JA01	Murata
L1	10 nH Chip Inductor	0603CS-10NX	Coilcraft
R1	0 Ω, 1 A Chip Resistor	ERJ2GE0R00X	Panasonic
PCB	Rogers R04350B, 0.010", ε _r = 3.66	M128499	MTL

50 OHM APPLICATION CIRCUIT: 1805–1880 MHz, 5 VOLT OPERATION

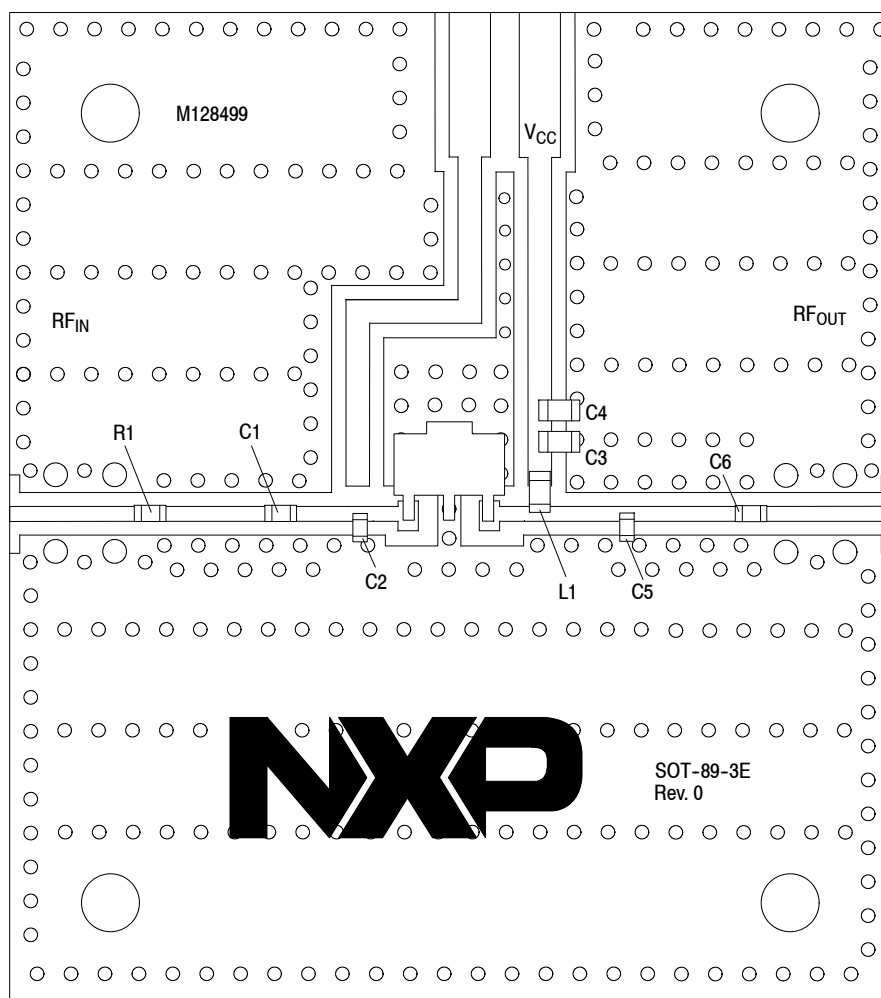

PCB actual size: 1.3" × 1.46".

Figure 13. MMG30301BT1 Test Circuit Component Layout

Table 11. MMG30301BT1 Test Circuit Component Designations and Values

Part	Description	Part Number	Manufacturer
C1	1.3 pF Chip Capacitor	GJM0225C1E1R3WB	Murata
C2	3.9 pF Chip Capacitor	GJM0225C1E3R9WB	Murata
C3	1000 pF Chip Capacitor	GCM1555R71E103KA37	Murata
C4	0.1 μ F Chip Capacitor	GRM1555R61A104KA01D	Murata
C5	3.3 pF Chip Capacitor	GJM0225C1E3R3WB	Murata
C6	100 pF Chip Capacitor	GRM1555C1H101JA01	Murata
L1	10 nH Chip Inductor	0603CS-10NX	Coilcraft
R1	0 Ω , 1 A Chip Resistor	ERJ2GE0R00X	Panasonic
PCB	Rogers R04350B, 0.010", $\epsilon_r = 3.66$	M128499	MTL

(Test Circuit Component Designations and Values table repeated for reference.)

50 OHM TYPICAL CHARACTERISTICS: 1805–1880 MHz, 5 VOLT OPERATION

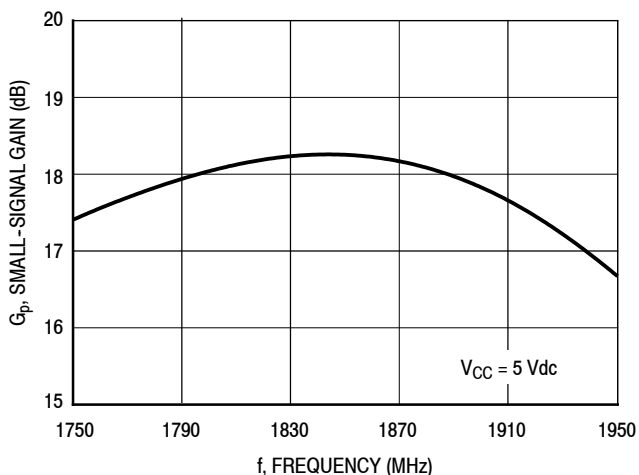

Figure 14. Small-Signal Gain (S21) versus Frequency

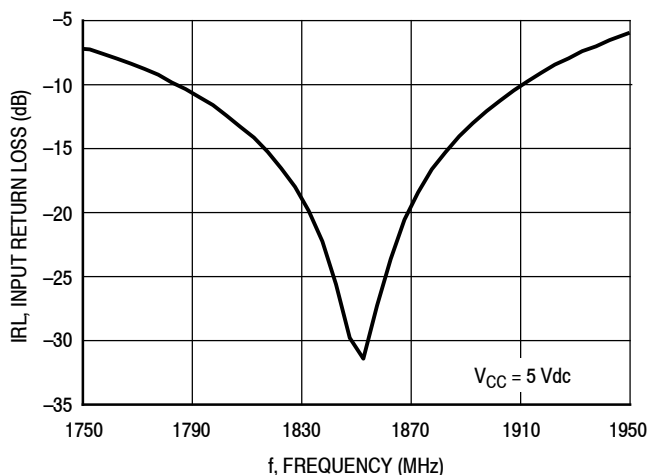

Figure 15. Input Return Loss (S11) versus Frequency

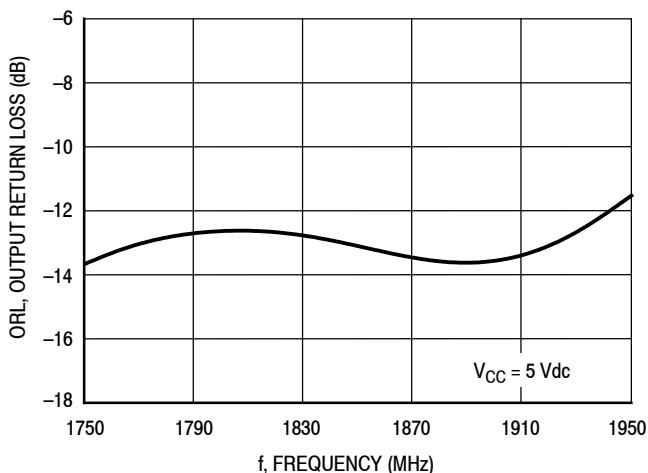
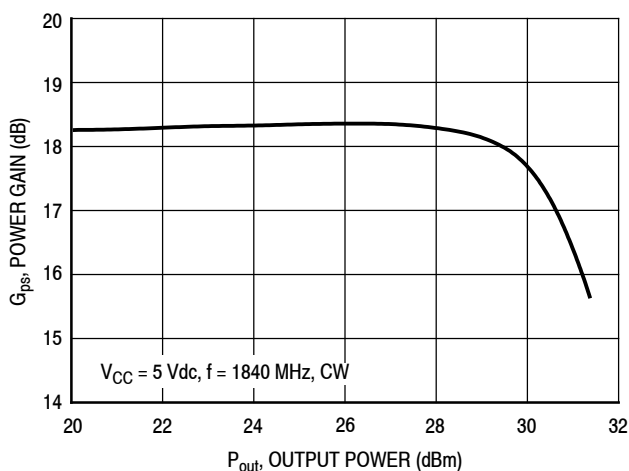

Figure 16. Output Return Loss (S22) versus Frequency



Note: Maximum allowable current not to exceed 240 mA

Figure 17. Power Gain versus Output Power

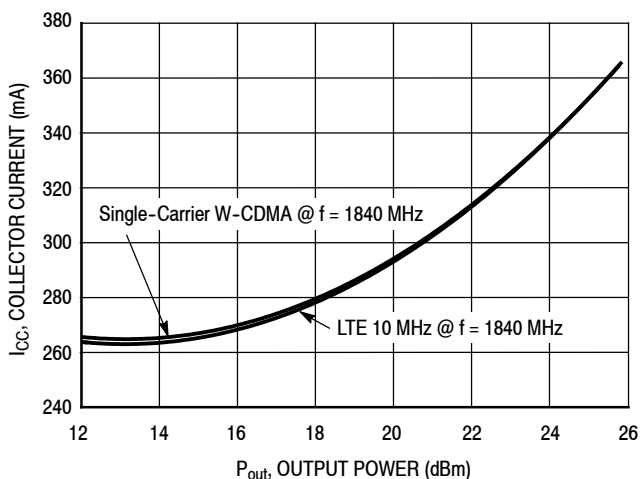

Figure 18. Collector Current versus Output Power

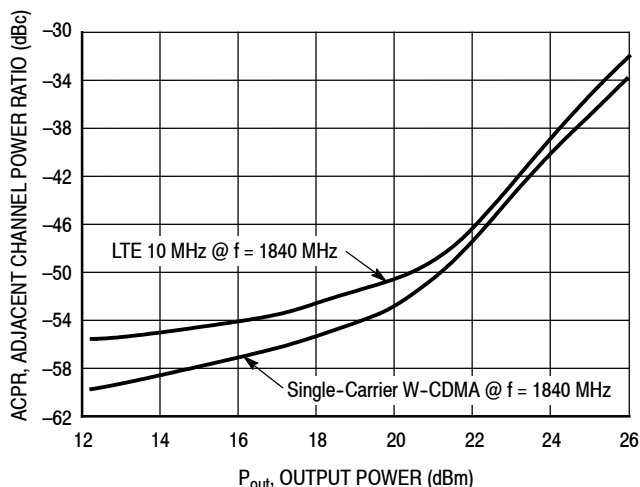
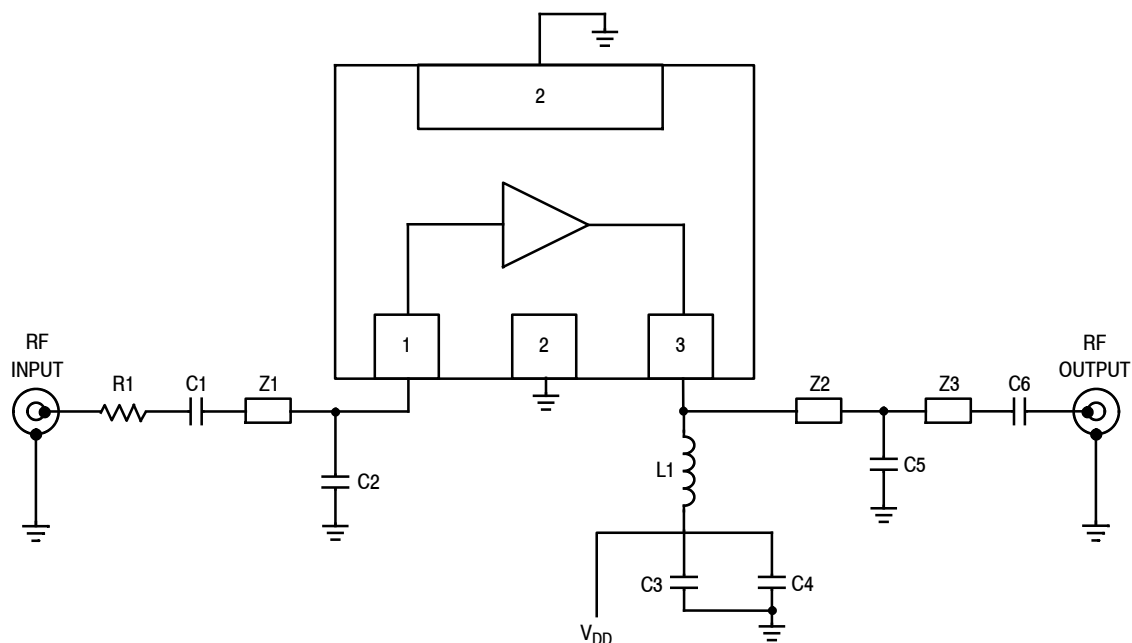

Figure 19. Adjacent Channel Power Ratio versus Output Power

50 OHM APPLICATION CIRCUIT: 1880–1920 MHz, 5 VOLT OPERATION



- Z1 0.105" × 0.02" Microstrip
- Z2 0.164" × 0.02" Microstrip
- Z3 0.14" × 0.02" Microstrip

Figure 20. MMG30301BT1 Test Circuit Schematic

Table 12. MMG30301BT1 Test Circuit Component Designations and Values

Part	Description	Part Number	Manufacturer
C1	1.2 pF Chip Capacitor	GJM0225C1E1R2WB	Murata
C2	3.3 pF Chip Capacitor	GJM0225C1E3R3WB	Murata
C3	1000 pF Chip Capacitor	GCM1555R71E103KA37	Murata
C4	0.1 μF Chip Capacitor	GRM1555R61A104KA01D	Murata
C5	2.7 pF Chip Capacitor	GJM0225C1E2R7WB	Murata
C6	100 pF Chip Capacitor	GRM1555C1H101JA01	Murata
L1	10 nH Chip Inductor	0603CS-10NX	Coilcraft
R1	0 Ω, 1 A Chip Resistor	ERJ2GE0R00X	Panasonic
PCB	Rogers R04350B, 0.010", ε _r = 3.66	M128499	MTL

50 OHM APPLICATION CIRCUIT: 1880–1920 MHz, 5 VOLT OPERATION

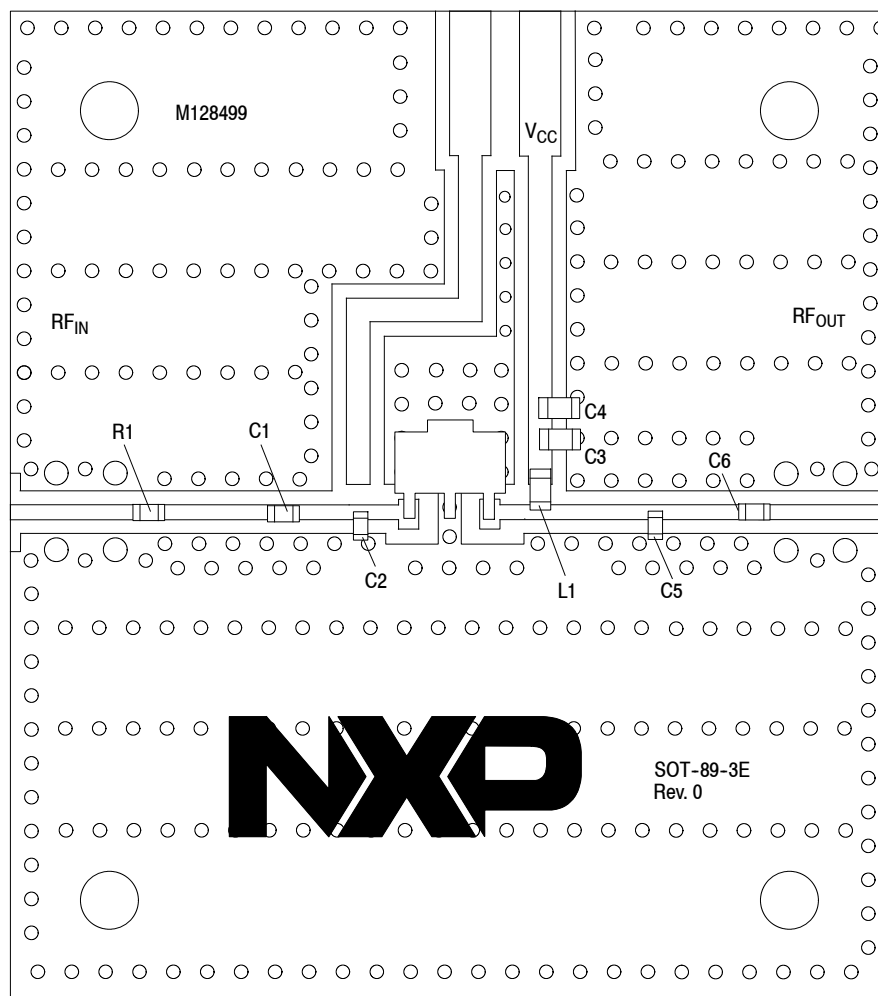

PCB actual size: 1.3" × 1.46".

Figure 21. MMG30301BT1 Test Circuit Component Layout

Table 12. MMG30301BT1 Test Circuit Component Designations and Values

Part	Description	Part Number	Manufacturer
C1	1.2 pF Chip Capacitor	GJM0225C1E1R2WB	Murata
C2	3.3 pF Chip Capacitor	GJM0225C1E3R3WB	Murata
C3	1000 pF Chip Capacitor	GCM1555R71E103KA37	Murata
C4	0.1 μ F Chip Capacitor	GRM1555R61A104KA01D	Murata
C5	2.7 pF Chip Capacitor	GJM0225C1E2R7WB	Murata
C6	100 pF Chip Capacitor	GRM1555C1H101JA01	Murata
L1	10 nH Chip Inductor	0603CS-10NX	Coilcraft
R1	0 Ω , 1 A Chip Resistor	ERJ2GE0R00X	Panasonic
PCB	Rogers R04350B, 0.010", $\epsilon_r = 3.66$	M128499	MTL

(Test Circuit Component Designations and Values table repeated for reference.)

50 OHM TYPICAL CHARACTERISTICS: 1880–1920 MHz, 5 VOLT OPERATION

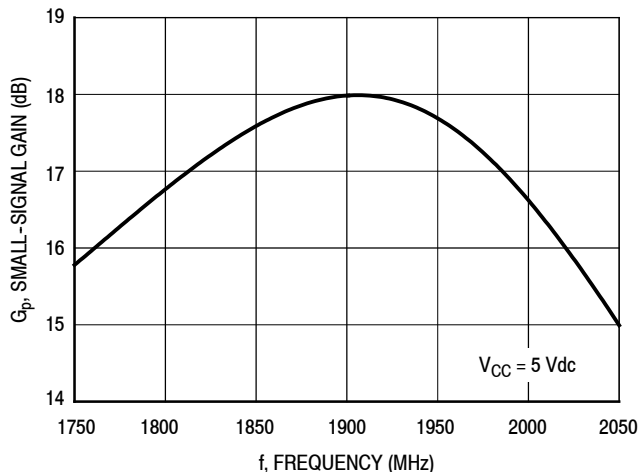

Figure 22. Small-Signal Gain (S21) versus Frequency

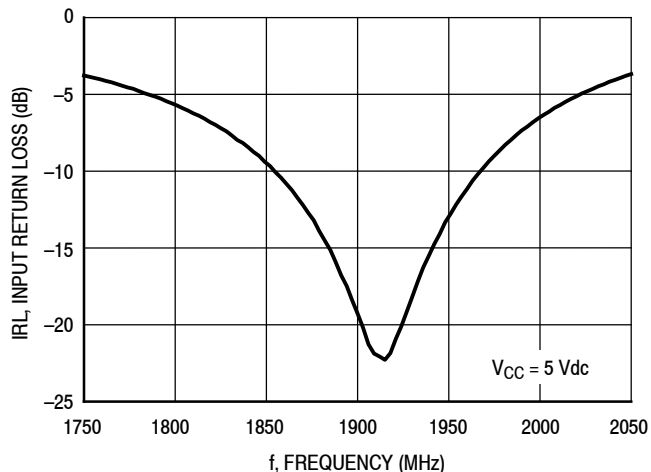

Figure 23. Input Return Loss (S11) versus Frequency

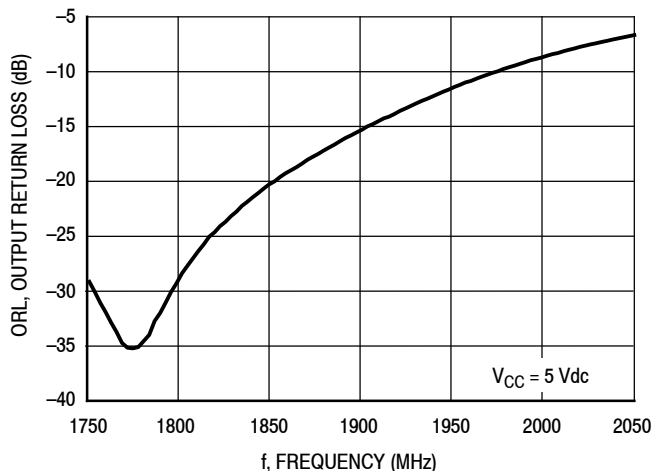
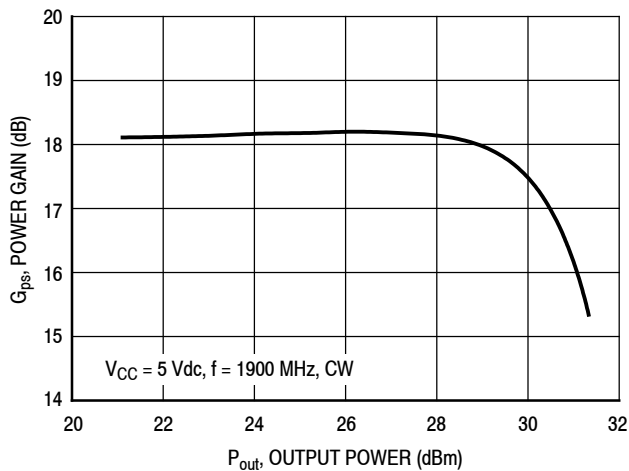

Figure 24. Output Return Loss (S22) versus Frequency



Note: Maximum allowable current not to exceed 480 mA.

Figure 25. Power Gain versus Output Power

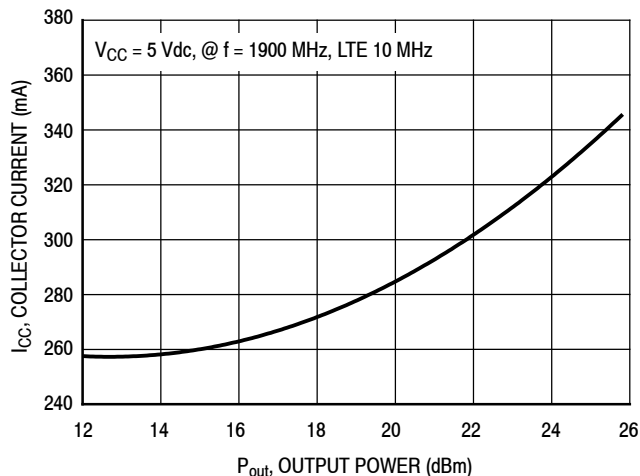

Figure 26. Collector Current versus Output Power

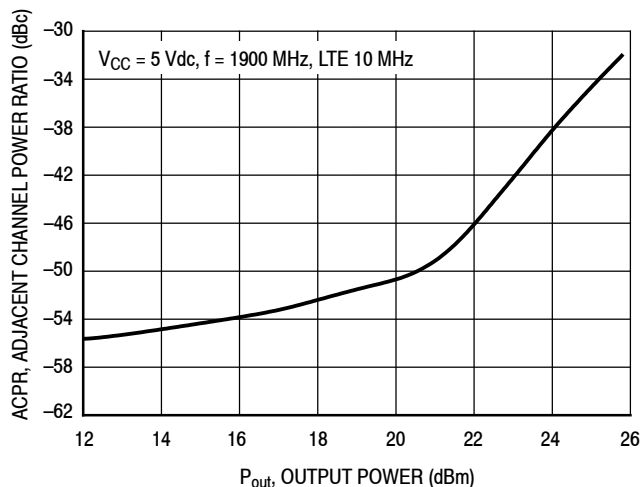

Figure 27. Adjacent Channel Power Ratio versus Output Power

50 OHM APPLICATION CIRCUIT: 2570–2620 MHz, 5 VOLT OPERATION

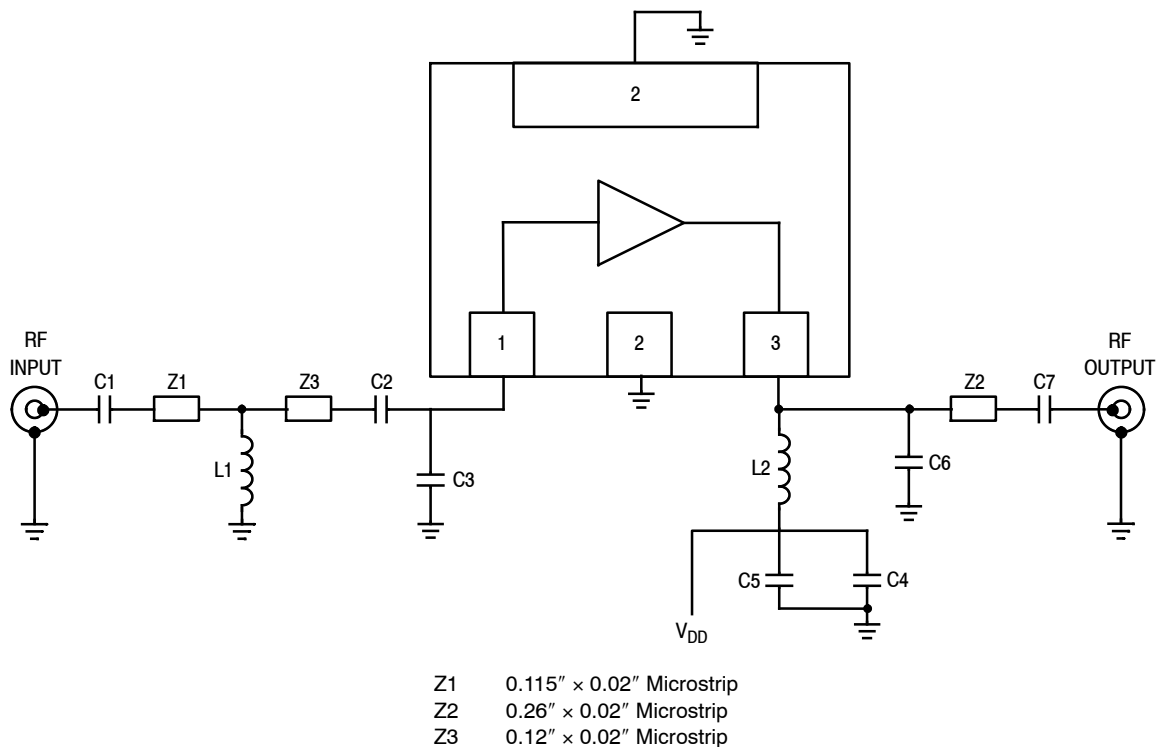
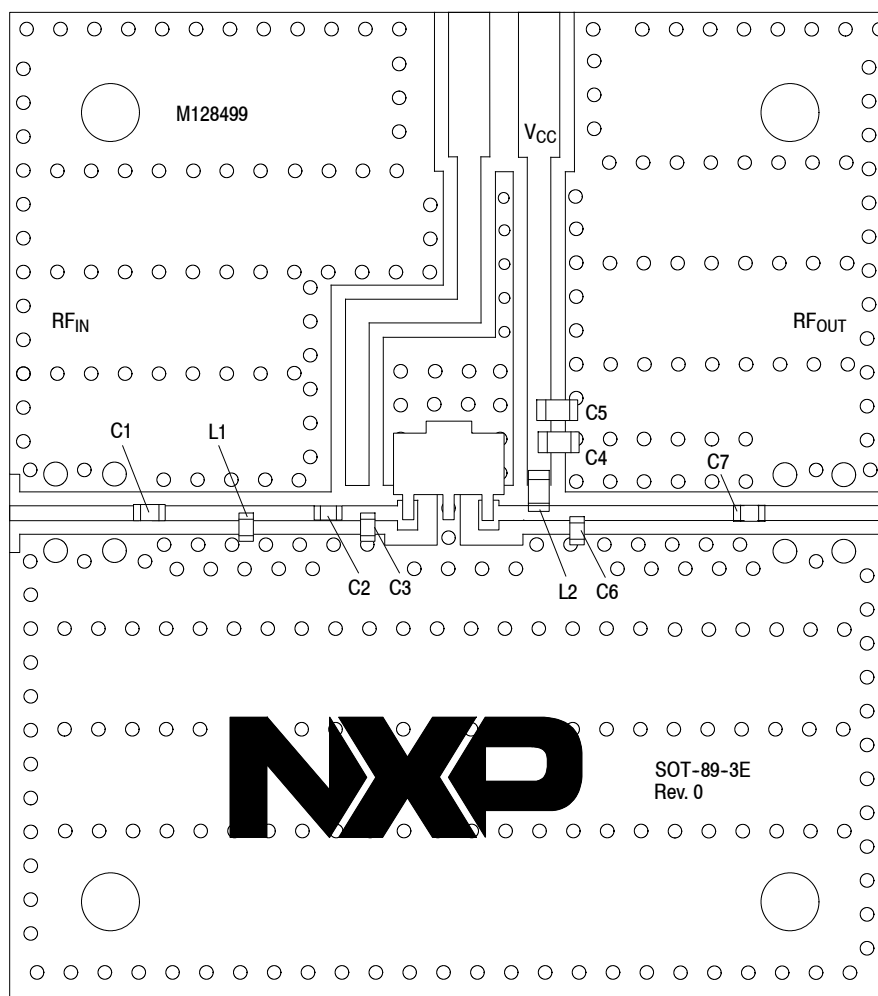

Figure 28. MMG30301BT1 Test Circuit Schematic

Table 13. MMG30301BT1 Test Circuit Component Designations and Values

Part	Description	Part Number	Manufacturer
C1, C7	100 pF Chip Capacitors	GRM1555C1H101JA01	Murata
C2	22 pF Chip Capacitor	GRM1555C1H220GA01	Murata
C3	3.3 pF Chip Capacitor	GJM0225C1E3R3WB	Murata
C4	0.01 μF Chip Capacitor	GRM188B11E103MA19L	Murata
C5	1 μF Chip Capacitor	GRM1555C81E105ME15	Murata
C6	2.7 pF Chip Capacitor	GJM0225C1E2R7WB	Murata
L1	1 nH Chip Inductor	LL1005-FHL1N0S	Toko
L2	10 nH Chip Inductor	0603CS-10NX	Coilcraft
PCB	Rogers R04350B, 0.010", $\epsilon_r = 3.66$	M128499	MTL

50 OHM APPLICATION CIRCUIT: 2570–2620 MHz, 5 VOLT OPERATION



PCB actual size: 1.3" × 1.46".

Figure 29. MMG30301BT1 Test Circuit Component Layout

Table 13. MMG30301BT1 Test Circuit Component Designations and Values

Part	Description	Part Number	Manufacturer
C1, C7	100 pF Chip Capacitors	GRM1555C1H101JA01	Murata
C2	22 pF Chip Capacitor	GRM1555C1H220GA01	Murata
C3	3.3 pF Chip Capacitor	GJM0225C1E3R3WB	Murata
C4	0.01 μ F Chip Capacitor	GRM188B11E103MA19L	Murata
C5	1 μ F Chip Capacitor	GRM1555C81E105ME15	Murata
C6	2.7 pF Chip Capacitor	GJM0225C1E2R7WB	Murata
L1	1 nH Chip Inductor	LL1005-FHL1N0S	Toko
L2	10 nH Chip Inductor	0603CS-10NX	Coilcraft
PCB	Rogers R04350B, 0.010", $\epsilon_r = 3.66$	M128499	MTL

(Test Circuit Component Designations and Values table repeated for reference.)

50 OHM TYPICAL CHARACTERISTICS: 2570–2620 MHz, 5 VOLT OPERATION

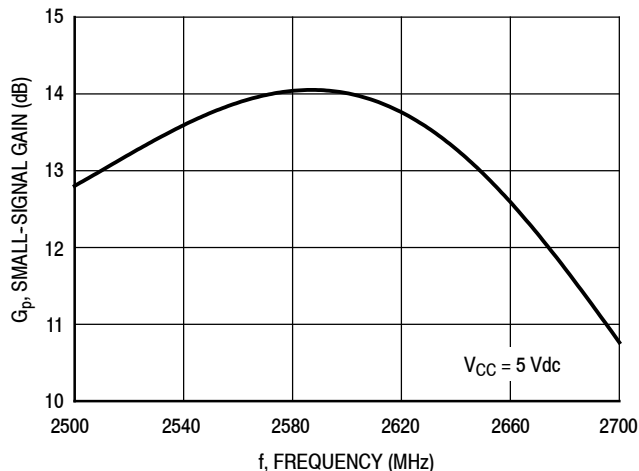

Figure 30. Small-Signal Gain (S21) versus Frequency

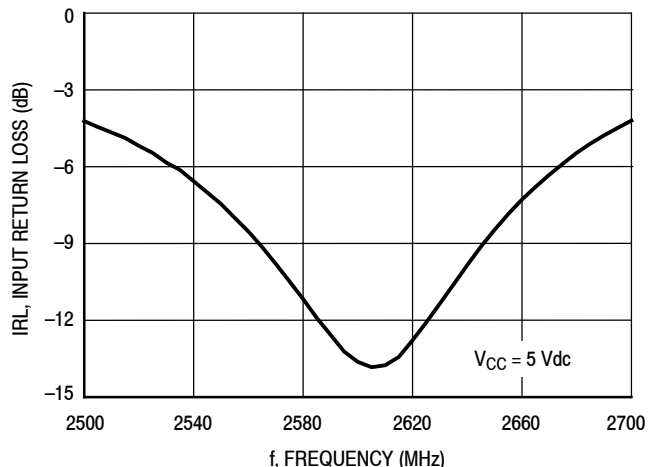

Figure 31. Input Return Loss (S11) versus Frequency

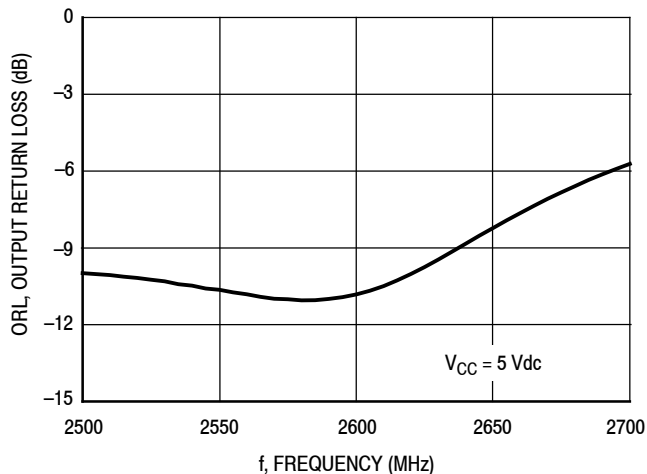

Figure 32. Output Return Loss (S22) versus Frequency

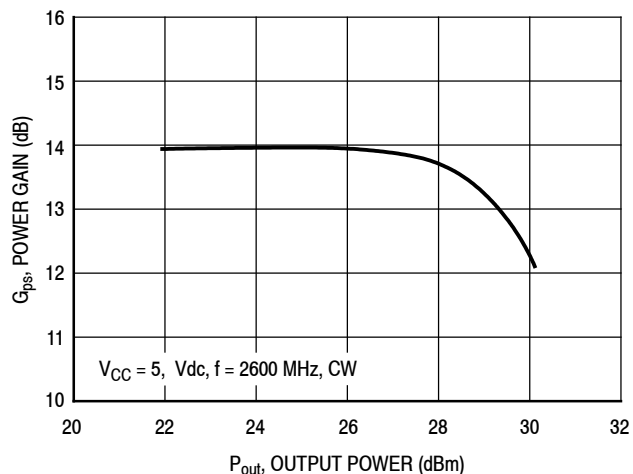

Figure 33. Power Gain versus Output Power

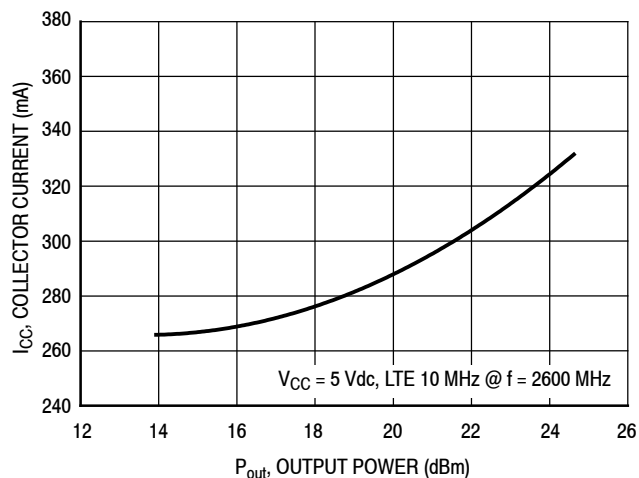

Figure 34. Collector Current versus Output Power

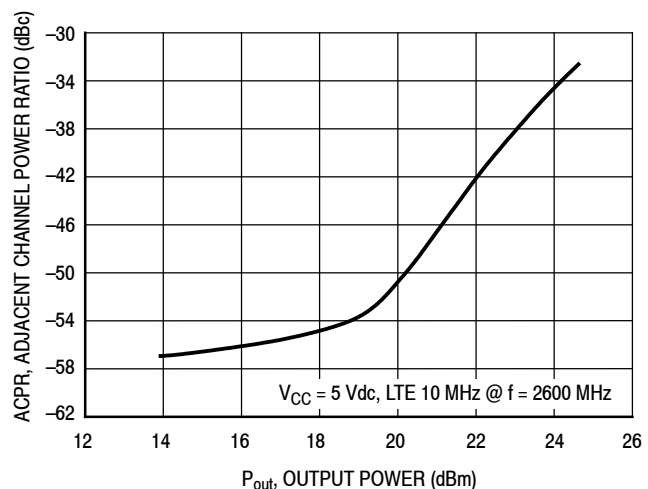
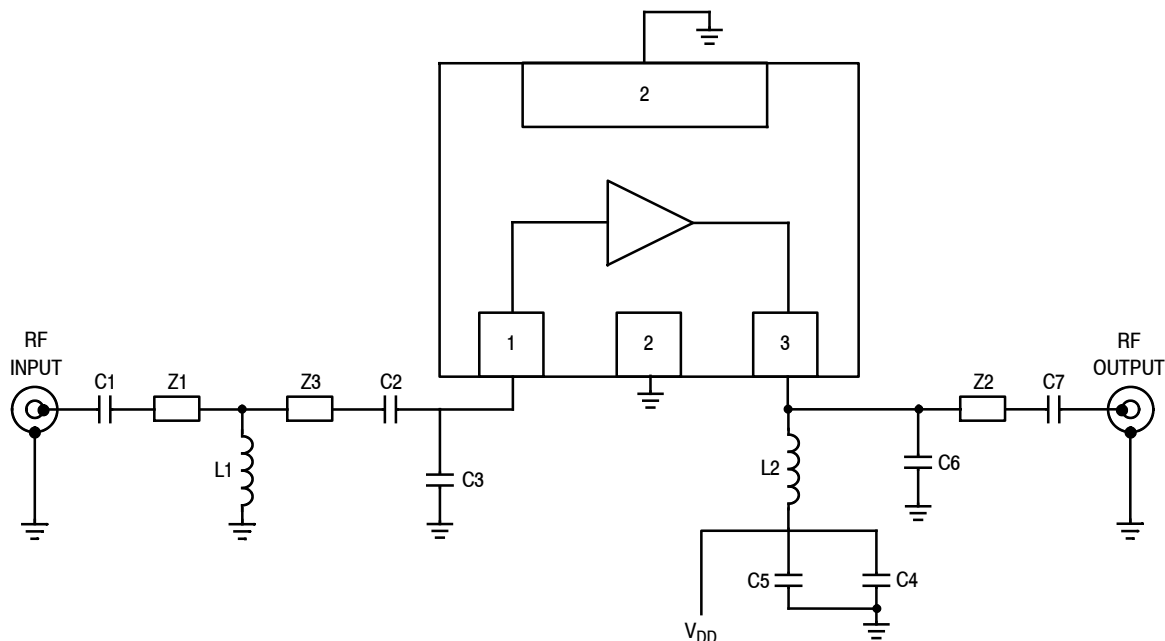

Figure 35. Adjacent Channel Power Ratio versus Output Power

50 OHM APPLICATION CIRCUIT: 2620–2690 MHz, 5 VOLT OPERATION



- Z1 0.115" × 0.02" Microstrip
- Z2 0.265" × 0.02" Microstrip
- Z3 0.09" × 0.02" Microstrip

Figure 36. MMG30301BT1 Test Circuit Schematic

Table 14. MMG30301BT1 Test Circuit Component Designations and Values

Part	Description	Part Number	Manufacturer
C1, C7	100 pF Chip Capacitors	GRM1555C1H101JA01	Murata
C2	22 pF Chip Capacitor	GRM1555C1H220GA01	Murata
C3	3.3 pF Chip Capacitor	GJM0225C1E3R3WB	Murata
C4	0.01 μF Chip Capacitor	GRM188B11E103MA19L	Murata
C5	1 μF Chip Capacitor	GRM1555C81E105ME15	Murata
C6	2.4 pF Chip Capacitor	GJM0225C1E2R4WB	Murata
L1	1 nH Chip Inductor	LL1005-FHL1N0S	Toko
L2	10 nH Chip Inductor	0603CS-10NX	Coilcraft
PCB	Rogers R04350B, 0.010", ε _r = 3.66	M128499	MTL

50 OHM APPLICATION CIRCUIT: 2620–2690 MHz, 5 VOLT OPERATION

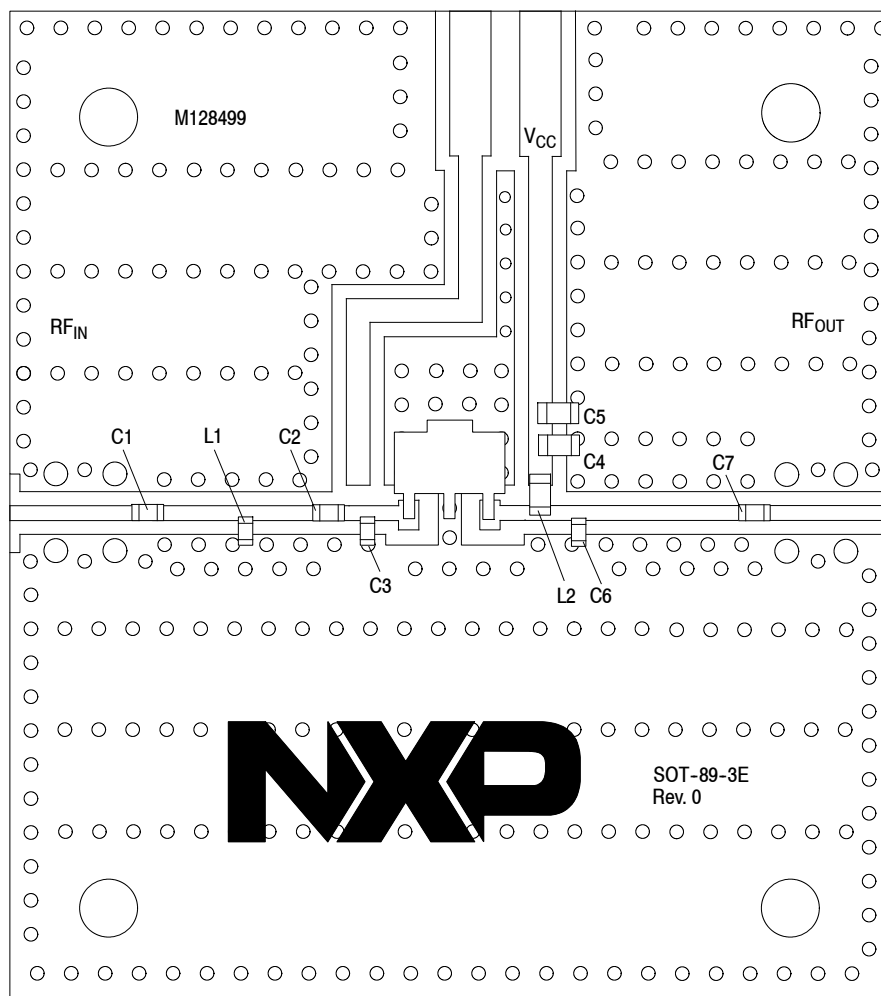

PCB actual size: 1.3" × 1.46".

Figure 37. MMG30301BT1 Test Circuit Component Layout

Table 14. MMG30301BT1 Test Circuit Component Designations and Values

Part	Description	Part Number	Manufacturer
C1, C7	100 pF Chip Capacitors	GRM1555C1H101JA01	Murata
C2	22 pF Chip Capacitor	GRM1555C1H220GA01	Murata
C3	3.3 pF Chip Capacitor	GJM0225C1E3R3WB	Murata
C4	0.01 μ F Chip Capacitor	GRM188B11E103MA19L	Murata
C5	1 μ F Chip Capacitor	GRM1555C81E105ME15	Murata
C6	2.4 pF Chip Capacitor	GJM0225C1E2R4WB	Murata
L1	1 nH Chip Inductor	LL1005-FHL1N0S	Toko
L2	10 nH Chip Inductor	0603CS-10NX	Coilcraft
PCB	Rogers R04350B, 0.010", $\epsilon_r = 3.66$	M128499	MTL

(Test Circuit Component Designations and Values table repeated for reference.)

50 OHM TYPICAL CHARACTERISTICS: 2620–2690 MHz, 5 VOLT OPERATION

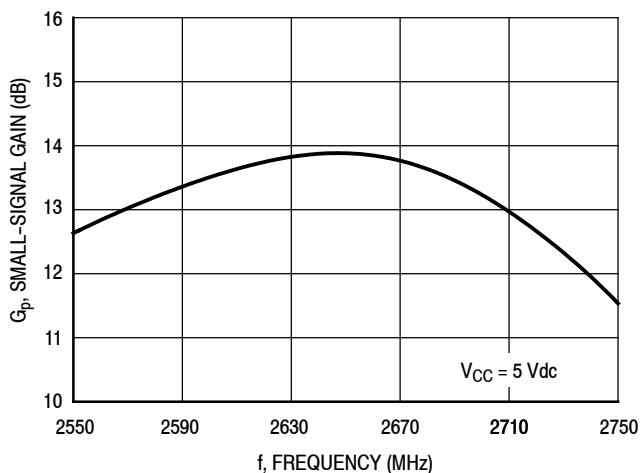

Figure 38. Small-Signal Gain (S21) versus Frequency

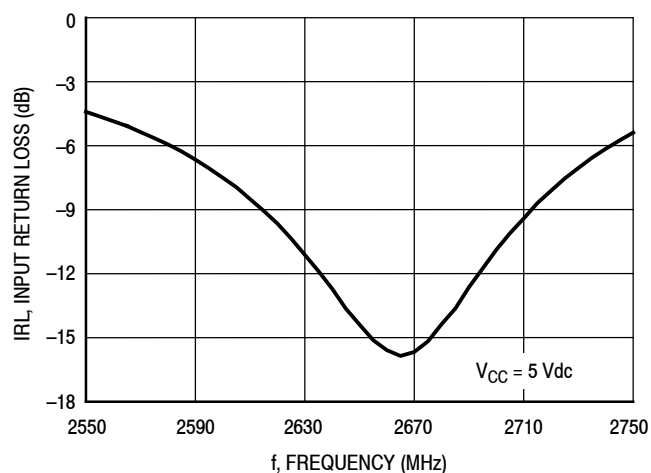

Figure 39. Input Return Loss (S11) versus Frequency

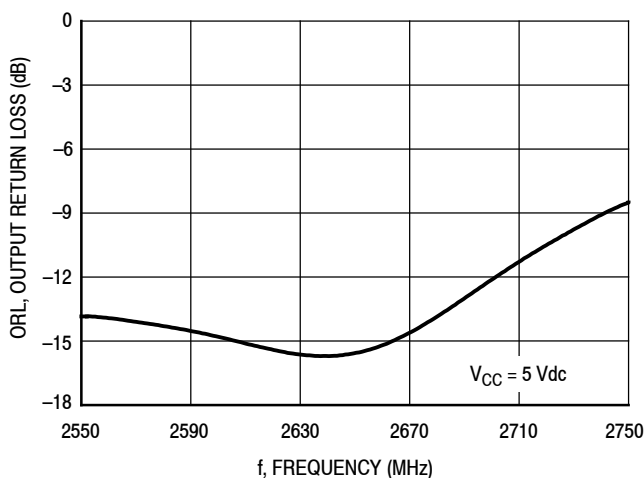

Figure 40. Output Return Loss (S22) versus Frequency

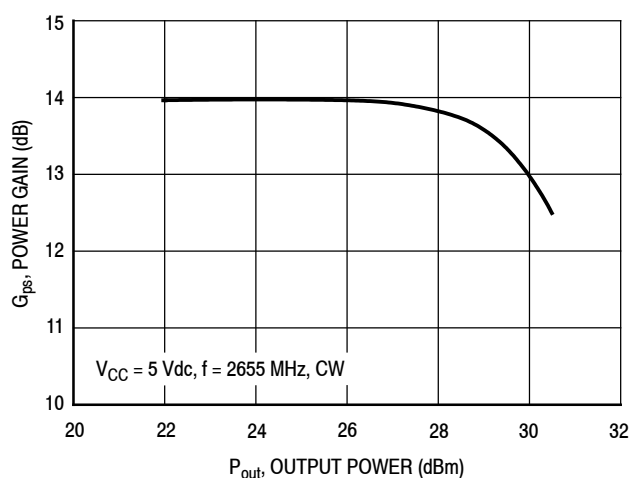

Figure 41. Power Gain versus Output Power

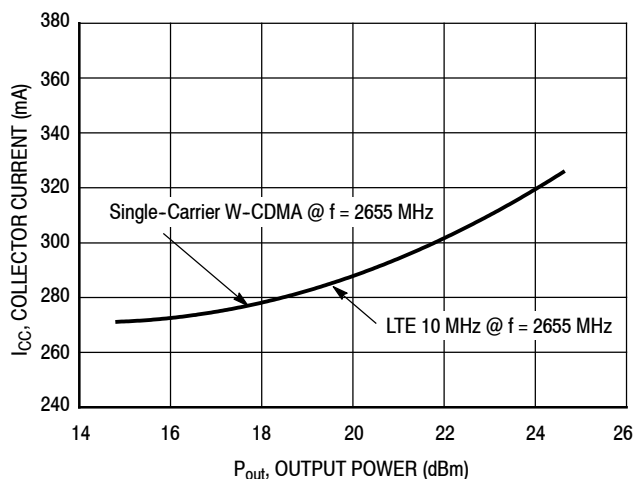

Figure 42. Collector Current versus Output Power

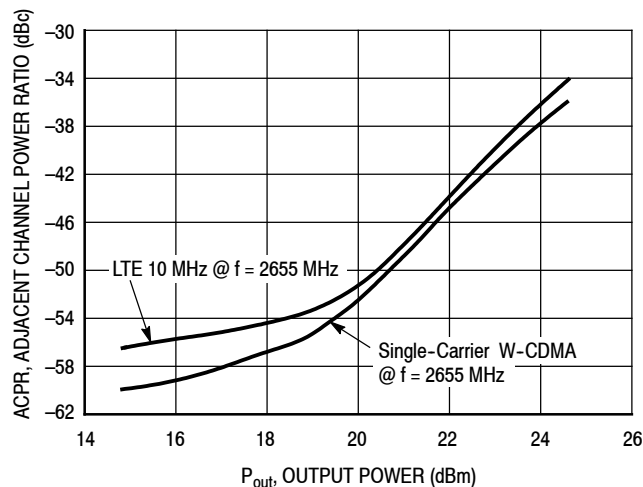
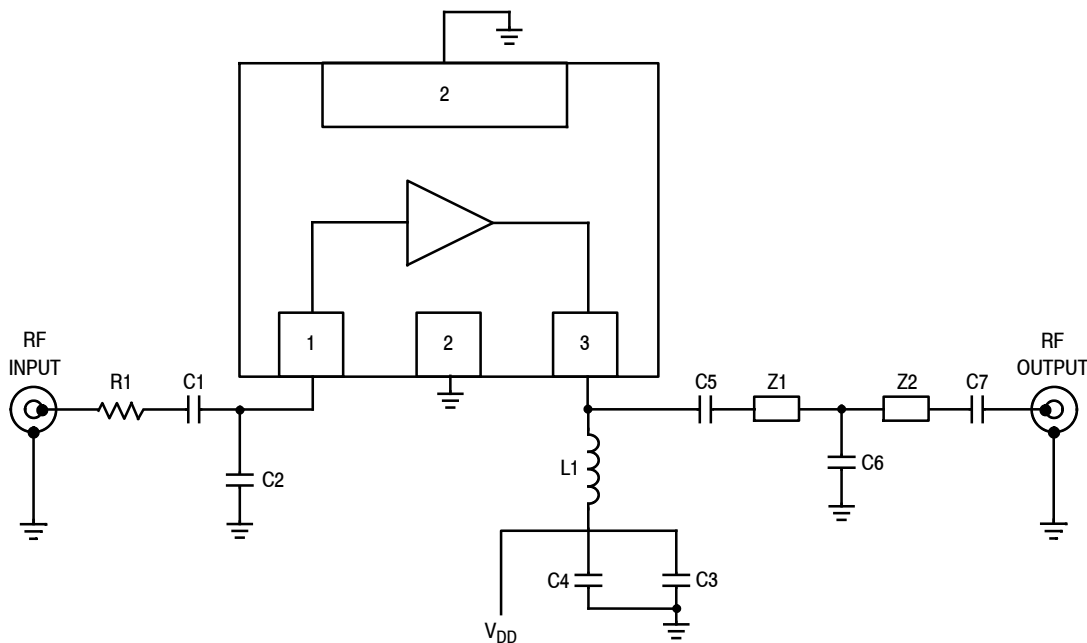

Figure 43. Adjacent Channel Power Ratio versus Output Power

50 OHM APPLICATION CIRCUIT: 3400–3600 MHz, 5 VOLT OPERATION



Z1 0.165" × 0.02" Microstrip
 Z2 0.105" × 0.02" Microstrip

Figure 44. MMG30301BT1 Test Circuit Schematic

Table 15. MMG30301BT1 Test Circuit Component Designations and Values

Part	Description	Part Number	Manufacturer
C1	0.3 pF Chip Capacitor	GJM0225C1ER30WB	Murata
C2	0.8 pF Chip Capacitor	GJM0225C1ER80WB	Murata
C3	1000 pF Chip Capacitor	GCM1555R71E103KA37	Murata
C4	0.1 μF Chip Capacitor	GRM1555R61A104KA01D	Murata
C5, C6	1.5 pF Chip Capacitors	GJM0225C1E1R5WB	Murata
C7	10 pF Chip Capacitor	GRM1555C1H100GA01	Murata
L1	6.8 nH Chip Inductor	0603CS-6N8X	Coilcraft
R1	0 Ω, 1 A Chip Resistor	ERJ2GE0R00X	Panasonic
PCB	Rogers R04350B, 0.010", ε _r = 3.66	M128499	MTL

50 OHM APPLICATION CIRCUIT: 3400–3600 MHz, 5 VOLT OPERATION

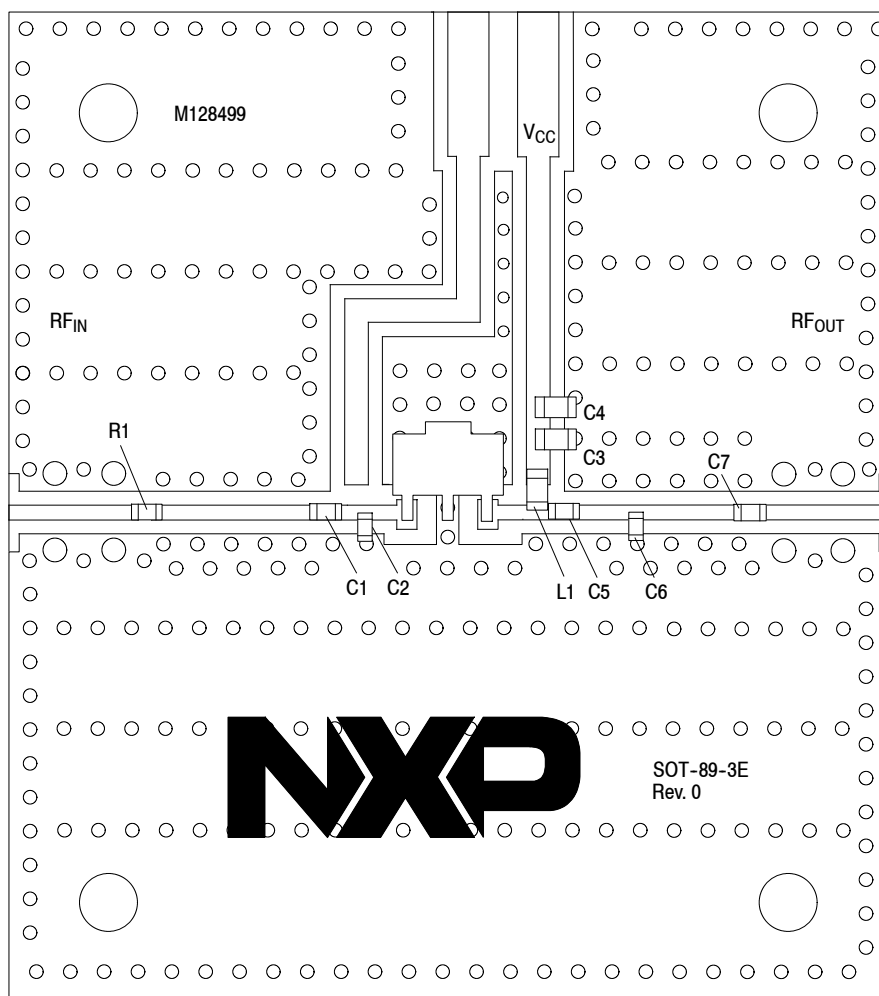

PCB actual size: 1.3" × 1.46".

Figure 45. MMG30301BT1 Test Circuit Component Layout

Table 15. MMG30301BT1 Test Circuit Component Designations and Values

Part	Description	Part Number	Manufacturer
C1	0.3 pF Chip Capacitor	GJM0225C1ER30WB	Murata
C2	0.8 pF Chip Capacitor	GJM0225C1ER80WB	Murata
C3	1000 pF Chip Capacitor	GCM1555R71E103KA37	Murata
C4	0.1 μ F Chip Capacitor	GRM1555R61A104KA01D	Murata
C5, C6	1.5 pF Chip Capacitors	GJM0225C1E1R5WB	Murata
C7	10 pF Chip Capacitor	GRM1555C1H100GA01	Murata
L1	6.8 nH Chip Inductor	0603CS-6N8X	Coilcraft
R1	0 Ω , 1 A Chip Resistor	ERJ2GE0R00X	Panasonic
PCB	Rogers R04350B, 0.010", $\epsilon_r = 3.66$	M128499	MTL

(Test Circuit Component Designations and Values table repeated for reference.)

50 OHM TYPICAL CHARACTERISTICS: 3400–3600 MHz, 5 VOLT OPERATION

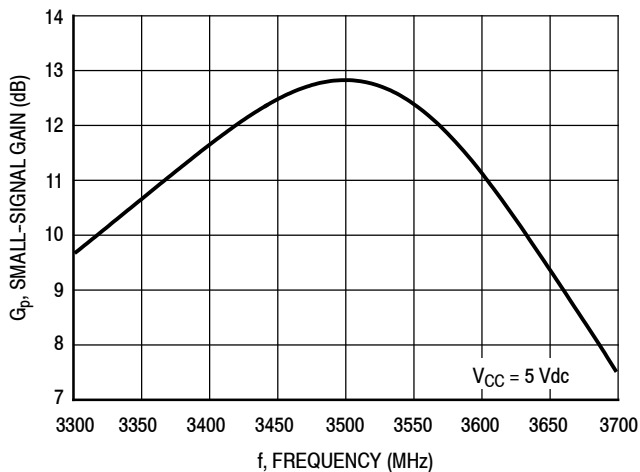

Figure 46. Small-Signal Gain (S21) versus Frequency

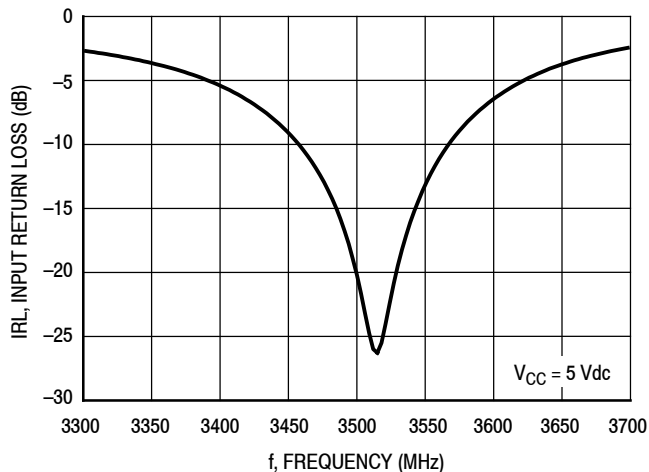

Figure 47. Input Return Loss (S11) versus Frequency

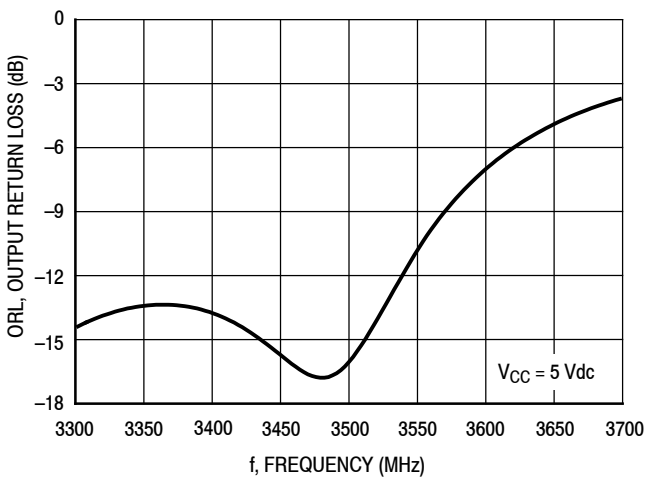

Figure 48. Output Return Loss (S22) versus Frequency

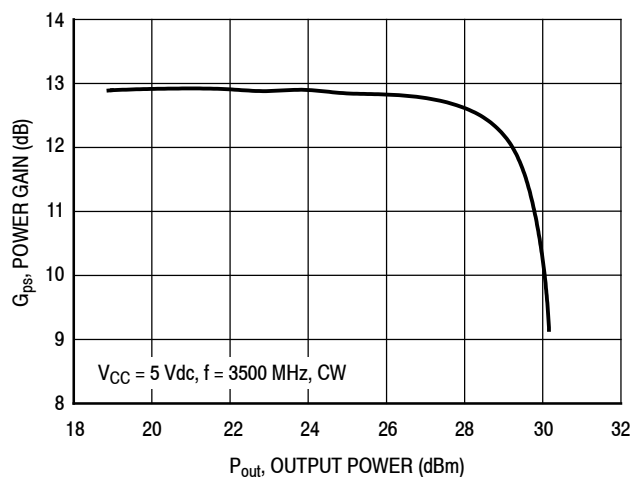

Figure 49. Power Gain versus Output Power

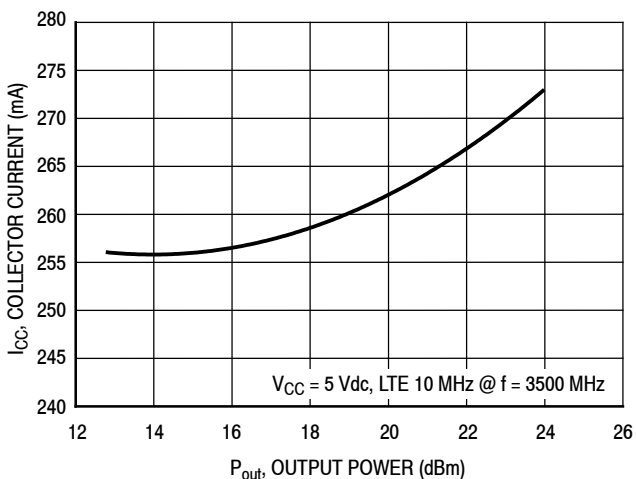

Figure 50. Collector Current versus Output Power

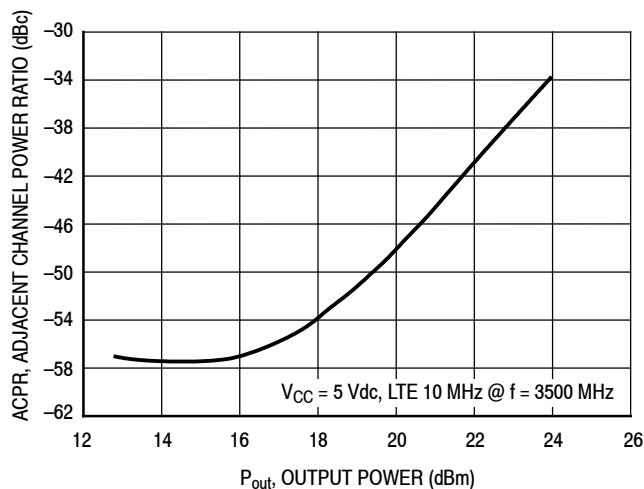

Figure 51. Adjacent Channel Power Ratio versus Output Power

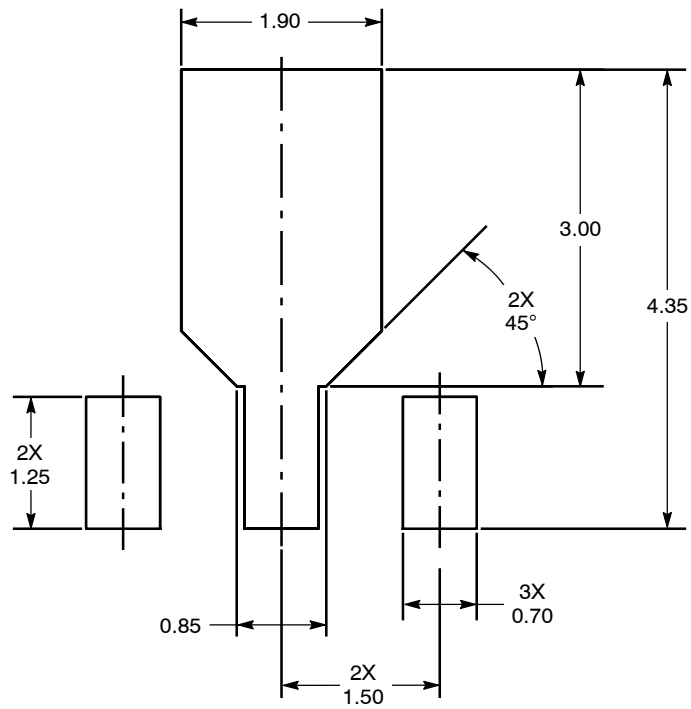

Figure 52. PCB Pad Layout for SOT-89A

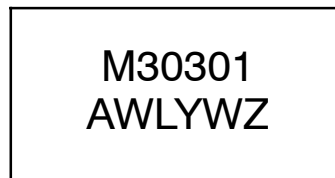
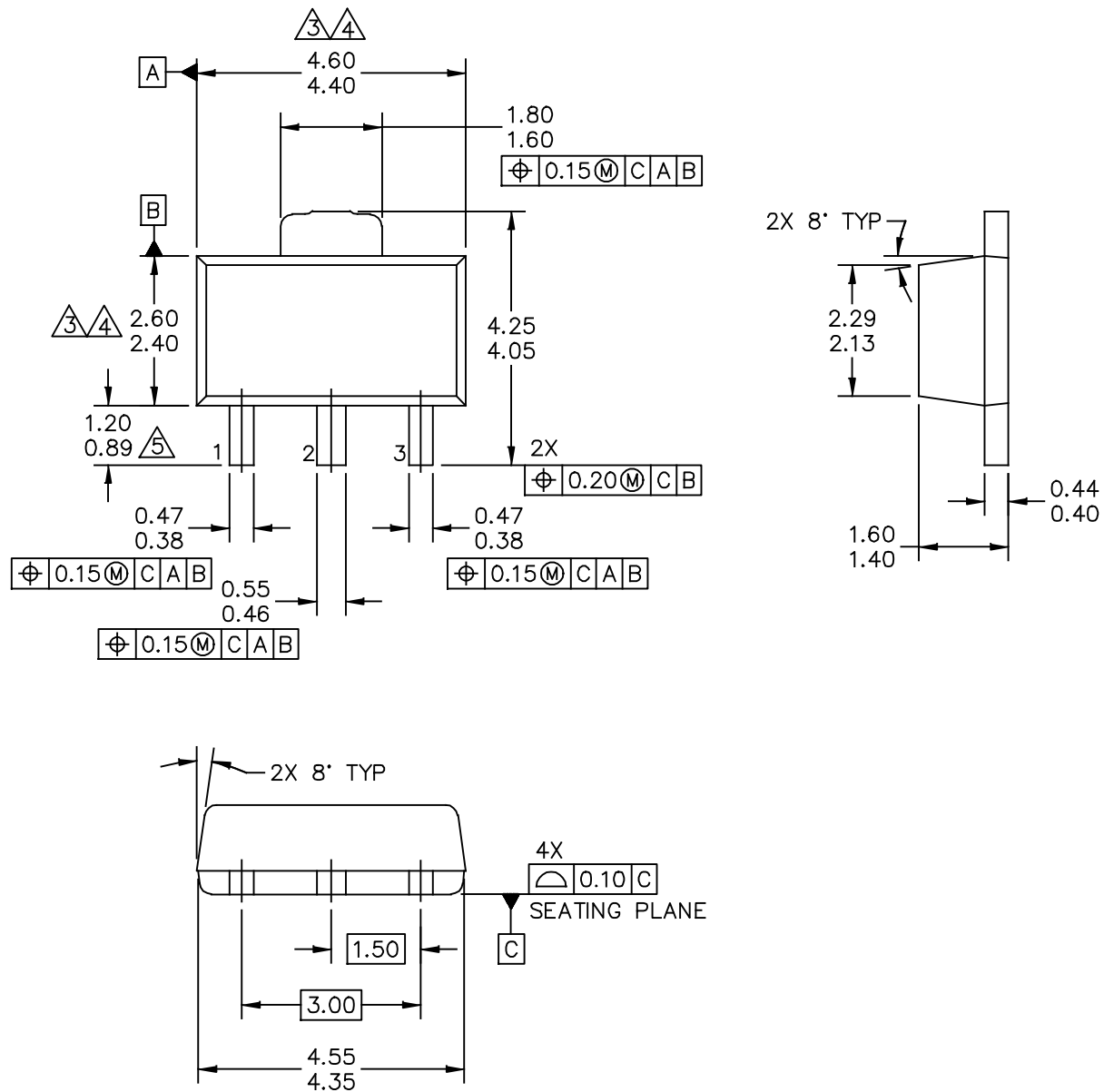
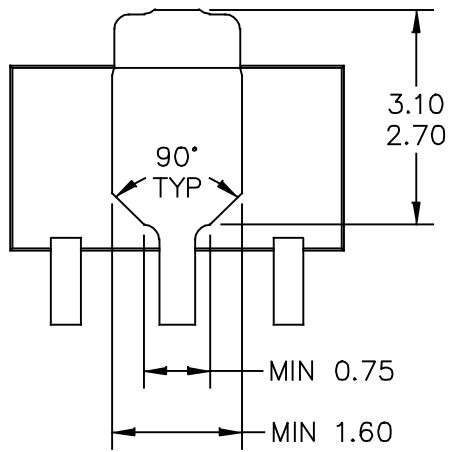

Figure 53. Product Marking

PACKAGE DIMENSIONS



© NXP SEMICONDUCTORS N. V. ALL RIGHTS RESERVED	MECHANICAL OUTLINE	PRINT VERSION NOT TO SCALE
TITLE: SOT-89A, 3 LEAD, 4.5 X 2.5 PKG, 1.5 MM PITCH	DOCUMENT NO: 98ASA00241D	REV: A
	STANDARD: NON-JEDEC	
	SOT1759-1	06 JAN 2016



BOTTOM VIEW

© NXP SEMICONDUCTORS N. V. ALL RIGHTS RESERVED	MECHANICAL OUTLINE	PRINT VERSION NOT TO SCALE	
TITLE: SOT-89A, 3 LEAD, 4.5 X 2.5 PKG, 1.5 MM PITCH		DOCUMENT NO: 98ASA00241D	REV: A
		STANDARD: NON-JEDEC	
		SOT1759-1	06 JAN 2016

NOTES:

1. DIMENSIONING AND TOLERANCING PER ASME Y14.5M – 1994.
2. ALL DIMENSIONS ARE IN MILLIMETERS.

3. DIMENSIONS DOES NOT INCLUDE MOLD FLASH. PROTRUSIONS OR GATE BURRS. MOLD FLASH, PROTRUSIONS OR GATE BURRS SHALL NOT EXCEED 0.5 MM PER END. DIMENSION DOES NOT INCLUDE INTERLEAD FLASH OR PROTRUSION. INTERLEAD FLASH OR PROTRUSION SHALL NOT EXCEED 0.5 MM PER SIDE.

4. DIMENSION ARE DETERMINED AT THE OUTMOST EXTREMES OF THE PLASTIC BODY EXCLUSIVE OF MOLD FLASH, TIE BAR BURRS, GATE BURRS AND INTERLEAD FLASH, BUT INCLUDING ANY MISMATCH BETWEEN THE TOP AND BOTTOM OF THE PLASTIC BODY.

5. TERMINAL NUMBERS ARE SHOWN FOR REFERENCE ONLY.

© NXP SEMICONDUCTORS N. V. ALL RIGHTS RESERVED	MECHANICAL OUTLINE	PRINT VERSION NOT TO SCALE	
TITLE: SOT-89A, 3 LEAD, 4.5 X 2.5 PKG, 1.5 MM PITCH		DOCUMENT NO: 98ASA00241D	REV: A
		STANDARD: NON-JEDEC	
		SOT1759-1	06 JAN 2016

PRODUCT DOCUMENTATION, SOFTWARE AND TOOLS

Refer to the following resources to aid your design process.

Application Notes

- AN1955: Thermal Measurement Methodology of RF Power Amplifiers

Software

- .s2p File

Development Tools

- Printed Circuit Boards

To Download Resources Specific to a Given Part Number:

1. Go to <http://www.nxp.com/RF>
2. Search by part number
3. Click part number link
4. Choose the desired resource from the drop down menu

FAILURE ANALYSIS

At this time, because of the physical characteristics of the part, failure analysis is limited to electrical signature analysis. In cases where NXP is contractually obligated to perform failure analysis (FA) services, full FA may be performed by third party vendors with moderate success. For updates contact your local NXP Sales Office.

REVISION HISTORY

The following table summarizes revisions to this document.

Revision	Date	Description
0	Oct. 2016	• Initial Release of Data Sheet

How to Reach Us:

Home Page:
nxp.com

Web Support:
nxp.com/support

Information in this document is provided solely to enable system and software implementers to use NXP products. There are no express or implied copyright licenses granted hereunder to design or fabricate any integrated circuits based on the information in this document. NXP reserves the right to make changes without further notice to any products herein.

NXP makes no warranty, representation, or guarantee regarding the suitability of its products for any particular purpose, nor does NXP assume any liability arising out of the application or use of any product or circuit, and specifically disclaims any and all liability, including without limitation consequential or incidental damages. "Typical" parameters that may be provided in NXP data sheets and/or specifications can and do vary in different applications, and actual performance may vary over time. All operating parameters, including "typicals," must be validated for each customer application by customer's technical experts. NXP does not convey any license under its patent rights nor the rights of others. NXP sells products pursuant to standard terms and conditions of sale, which can be found at the following address: nxp.com/SalesTermsandConditions.

NXP, the NXP logo, Freescale, and the Freescale logo are trademarks of NXP B.V. All other product or service names are the property of their respective owners.
© 2016 NXP B.V.





Компания «ЭлектроПласт» предлагает заключение долгосрочных отношений при поставках импортных электронных компонентов на взаимовыгодных условиях!

Наши преимущества:

- Оперативные поставки широкого спектра электронных компонентов отечественного и импортного производства напрямую от производителей и с крупнейших мировых складов;
- Поставка более 17-ти миллионов наименований электронных компонентов;
- Поставка сложных, дефицитных, либо снятых с производства позиций;
- Оперативные сроки поставки под заказ (от 5 рабочих дней);
- Экспресс доставка в любую точку России;
- Техническая поддержка проекта, помощь в подборе аналогов, поставка прототипов;
- Система менеджмента качества сертифицирована по Международному стандарту ISO 9001;
- Лицензия ФСБ на осуществление работ с использованием сведений, составляющих государственную тайну;
- Поставка специализированных компонентов (Xilinx, Altera, Analog Devices, Intersil, Interpoint, Microsemi, Aeroflex, Peregrine, Syfer, Eurofarad, Texas Instrument, Miteq, Cobham, E2V, MA-COM, Hittite, Mini-Circuits, General Dynamics и др.);

Помимо этого, одним из направлений компании «ЭлектроПласт» является направление «Источники питания». Мы предлагаем Вам помощь Конструкторского отдела:

- Подбор оптимального решения, техническое обоснование при выборе компонента;
- Подбор аналогов;
- Консультации по применению компонента;
- Поставка образцов и прототипов;
- Техническая поддержка проекта;
- Защита от снятия компонента с производства.



Как с нами связаться

Телефон: 8 (812) 309 58 32 (многоканальный)

Факс: 8 (812) 320-02-42

Электронная почта: org@eplast1.ru

Адрес: 198099, г. Санкт-Петербург, ул. Калинина, дом 2, корпус 4, литера А.