

Sprague-Goodman

ENGINEERING BULLETIN
SG-205B
Supercedes SG-205A

PISTONCAP® PRECISION TRIMMER CAPACITORS

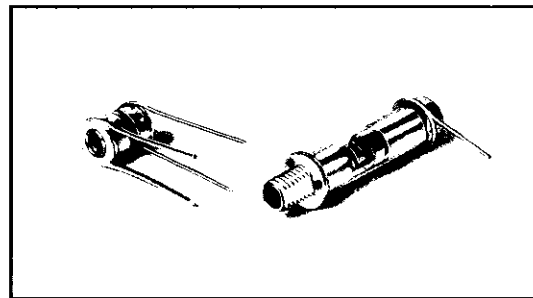
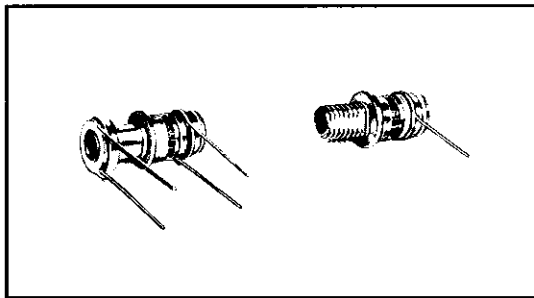

Sprague-Goodman Electronics, Inc.

1700 SHAMES DRIVE, WESTBURY, NY 11590

TEL: 516-334-8700 • FAX: 516-334-8771

PRECISION ADJUST MECHANISMS

All Sprague-Goodman Pistoncap Trimmer Capacitors described in U. S. Patent No. 3,840,786 utilize a simplified and highly reliable adjust mechanism. There are two slots 180° apart, more than half way through the bushing threads. Following slotting, the bushing is compressed, causing the slotted end to behave as a spring. The threaded segments of the bushing are biased axially, pressing the bushing threads firmly into flank-to-flank engagement with the screw threads. This eliminates all backlash and provides the required smooth and uniform adjust torque. Note that no extra threaded washers, springs, etc. are required. Fewer parts mean greater reliability.

JFD PISTONCAP models, now manufactured by Sprague-Goodman, include the differential and split-stator types shown on page 11 of this bulletin. High Voltage and High RF Voltage quartz dielectric models are on page 15.



FORM FACTOR R, PANEL MOUNTING
SEALED CONSTRUCTION

COLLARED BUSHING STYLES (Form Factors N and V). Certain applications require that the head of the adjusting screw remain wholly within the bushing over the entire range of adjustment. To meet this need, collared bushing types, both sealed and unsealed, have been added to the broad line of printed circuit mounting styles. All panel mounting styles, other than the 'W' series, are also designed for blind hole tuning.



FORM FACTOR C, OPEN END

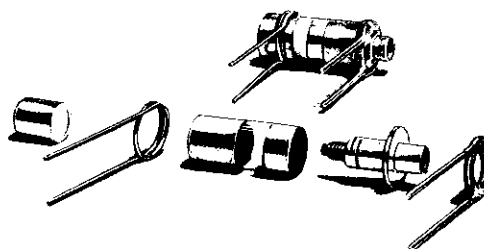

FORM FACTOR N, COLLARED BUSHING
OPEN END

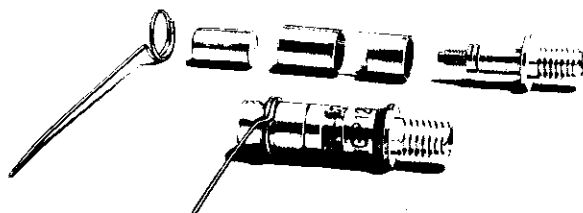

FORM FACTOR P, OPEN END

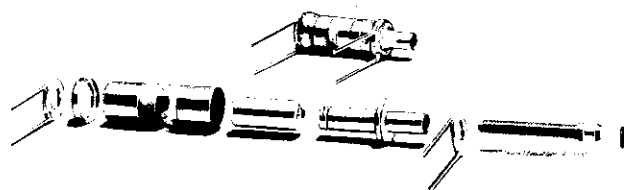

FORM FACTOR V, COLLARED BUSHING
SEALED CONSTRUCTION

SEALED TYPES. Sealed versions are available in both panel mounting and printed circuit mounting. The electrode end is sealed either by closing the end of the glass tube or by soldering on a turret cap. The adjust end is sealed by means of a multi-lobed seal. This seal provides twice as many lobes as an "O" ring and good sealing is provided with one-quarter of the gasket compression required for an "O" ring.

W STYLES. In some panel-mounting applications, a protruding adjust screw is required. In W series capacitors, the adjust screw protrudes from the mounting bushing for all positions of adjustment.



FORM FACTOR L, PRINTED CIRCUIT SEALED



FORM FACTOR W

THREE DIELECTRICS. Three dielectrics are available. The standard glass has a dielectric constant of about 6.7 and a dissipation factor of about 0.0012. High-range glass achieves the unusual combination of higher dielectric constant but lower dissipation factor of about 8.5 and about 0.008, respectively. Quartz dielectric has the much lower dielectric constant of about 3.7 but has extremely low loss, for a dissipation factor of about 0.0001.

Generally, the standard glass, which is least expensive, will suit most applications. For some applications where higher capacitance and/or greater Q is required for a given physical structure, high-range glass should be specified. For applications involving moderate r-f currents, fused quartz is used.

High-range glass trimmers will generally cost about 25% more than standard glass and quartz trimmers are about three times the price of standard glass trimmers. Expanded range types generally cost about 2.5 times the non-expanded range equivalents.

EXPANDED RANGE models are available in both panel mounting and printed circuit mounting styles,

sealed and unsealed. The electrode band is embedded within the wall of the glass tube, providing a thinner dielectric gap and, at the same time, keeping the overall wall thick enough for mechanical strength. This generally yields about three times the capacitance range for a given size compared with the standard Pistoncap Capacitors. This is accomplished by a laminating technique. An electrode band is metallized on the O.D. of a thin (0.005") glass tube and a slightly larger and heavier walled tube is then telescoped over it. The two tubes are then fused, providing the embedded structure. Additional metallization is then added at both ends to provide electrical and mechanical termination.



FORM FACTOR R, EXPANDED RANGE

MILITARY APPROVALS

Pistoncap Precision Trimmer Capacitors are approved to Military Specification MIL-C-14409D, Styles PC35, PC37, PC38, PC39, PC40, PC41, PC42, PC43, PC48, PC50, PC51, and PC 52 in all characteristics and values and are listed on the Qualified Products List (QPL) for this specification. In Canada, these capacitors have been approved by the Department of National Defense in accordance with the terms of the U.S.-Canada agreement for qualification

of products of non-resident manufacturers. In the United Kingdom, these capacitors have been approved by the Ministry of Defense (DCVD) in accordance with the provisions of STANAG 4093, while in West Germany they have been approved by the Bundesamt für Wehrtechnik und Beschaffung (BWB) for G-QPL in accordance with STANAG 4093.

PART NUMBERING SYSTEM



PRINTED CIRCUIT MOUNTING



Figure 1A



Figure 1B

Capacitance Range in pF Min. Max.	D-C Voltage Rating (Volts)	Temp. Char. (See Table)	Minimum Quality Factor Q	OPEN END STYLE (Fig. 1A)				COLLARED BUSHING STYLE (Fig. 1B)			
				Model No.	Mil Designation	A Max. In. mm	B ± 0.031 (0.79) In. mm	Model No.	A Max. In. mm	B ± 0.031 (0.79) In. mm	
STANDARD GLASS DIELECTRIC											
0.8 4.5	750	J	500	GGC4R500	*PC41J4R5	0.312 7.92	0.250 6.35	GGN4R500	0.343 8.71	0.250 6.35	
0.8 8.5	750	J	500	GGC8R500	*PC41J8R5	0.562 14.27	0.438 11.13	GGN8R500	0.593 15.06	0.438 11.13	
0.8 12.0	750	H	500	GGC12000	*PC41H120	0.766 19.46	0.625 15.88	GGN12000	0.797 20.24	0.625 15.88	
0.8 18.0	750	H	500	GGC18000	*PC41H180	1.000 25.40	0.875 22.23	GGN18000	1.031 26.19	0.875 22.23	
0.8 30.0	750	H	350	GGC30000	*PC41H300	1.609 40.87	1.375 34.93	GGN30000	1.640 41.66	1.375 34.93	
HI-RANGE GLASS DIELECTRIC											
0.8 5.5	750	J	1000	GHC5R500	PC51J5R5	0.312 7.92	0.250 6.35	GHN5R500	0.343 8.71	0.250 6.35	
0.8 11.0	750	J	900	GHC11000	PC51J110	0.562 14.27	0.438 11.13	GHN11000	0.593 15.06	0.438 11.13	
0.8 16.0	750	H	800	GHC16000	PC51H160	0.766 19.46	0.625 15.88	GHN16000	0.797 20.24	0.625 15.88	
0.8 23.0	750	H	700	GHC23000	PC51H230	1.000 25.40	0.875 22.23	GHN23000	1.031 26.19	0.875 22.23	
0.8 38.0	750	H	500	GHC38000	PC51H380	1.609 40.87	1.375 34.93	GHN38000	1.640 41.66	1.375 34.93	
QUARTZ DIELECTRIC											
0.6 1.8	750	Q	1500	GQC1R800	PC41Q1R8	0.312 7.92	0.250 6.35				
0.6 5.5	750	Q	1500	GQC5R500	PC41Q5R5	0.562 14.27	0.438 11.13				
0.6 9.5	750	Q	1500	GQC9R500	PC41Q9R5	1.000 25.40	0.875 22.23				
0.8 16.0	750	Q	1500	GQC16000	PC41Q160	1.609 40.87	1.375 34.93				

*These capacitors were listed in MIL-C-14409B but do not appear in MIL-C-14409D.

MODIFICATIONS

To specify the modifications shown below, replace the last two digits of the catalog number with the modification no. See page 3.



No. 06
CYLINDER END CLOSED



No. 16
BASE LUG, SINGLE LEAD



No. 17
BASE LUG, DOUBLE LEAD

EXPANDED RANGE PRINTED CIRCUIT MOUNTING

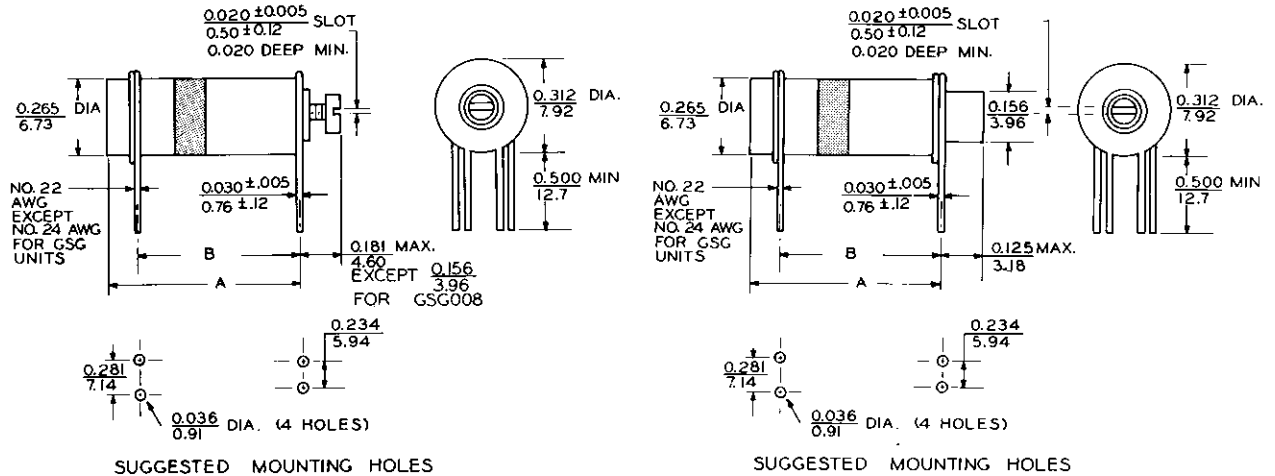

Figure 1C

Figure 1D

Capacitance Range in pF Min. Max.	D-C Voltage Rating (Volts)	Temp. Char. (See Table)	Minimum Quality Factor Q	OPEN END STYLE (Fig. 1C)				COLLARED BUSHING STYLE (Fig. 1D)			
				Model No.	A Max. In. mm	B ± 0.031 (0.79) In. mm	Model No.	A Max. In. mm	B ± 0.031 (0.79) In. mm		
STANDARD GLASS DIELECTRIC											
1.2 10.0	500	Y	500	GSG008	0.277 7.04	0.250 6.35	—	—	—	—	—
1.0 14.0	750	G	500	GEC14000	0.391 9.93	0.328 8.33	GEN14000	0.422 10.72	0.328 8.33	—	—
1.0 28.0	750	G	350	GEC28000	0.625 15.88	0.500 12.70	GEN28000	0.656 16.66	0.500 12.70	—	—
1.0 42.0	750	G	250	GEC42000	0.843 21.41	0.734 18.64	GEN42000	0.875 22.23	0.734 18.64	—	—
1.0 60.0	750	G	250	GEC60000	1.093 27.76	0.906 23.01	GEN60000	1.125 28.58	0.906 23.01	—	—
1.0 90.0	750	G	250	GEC90000	1.688 42.88	1.516 38.51	GEN90000	1.719 43.66	1.516 38.51	—	—
HI-RANGE GLASS DIELECTRIC											
1.2 16.0	500	Y	750	GSG009	0.323 8.20	0.250 6.35	—	—	—	—	—
1.0 16.0	750	G	750	GFC16000	0.391 9.93	0.328 8.33	GFN16000	0.422 10.72	0.328 8.33	—	—
1.0 36.0	750	G	550	GFC36000	0.625 15.88	0.500 12.70	GFN36000	0.656 16.66	0.500 12.70	—	—
1.0 52.0	750	G	350	GFC52000	0.843 21.41	0.734 18.64	GFN52000	0.875 22.23	0.734 18.64	—	—
1.0 75.0	750	G	250	GFC75000	1.093 27.76	0.906 23.01	GFN75000	1.125 28.58	0.906 23.01	—	—
1.0 120.0	750	G	250	GFC12100	1.688 42.88	1.516 38.51	GFN12100	1.719 43.66	1.516 38.51	—	—

NOTE: Capacitance increases up to 0.5 pF on vertical modifications due to position of leads alongside capacitor body.



SEALED PRINTED CIRCUIT MOUNTING



Figure 2A



Figure 2B

Capacitance Range in pF Min. Max.	D-C Voltage Rating (Volts)	Temp. Char. (See Table)	Minimum Quality Factor Q	STANDARD SEALED STYLE (Fig. 2A)				COLLARED BUSHING SEALED STYLE (Fig. 2B)													
				Model No.	Mil Designation	A Max. In. mm	B ± 0.031 (0.79) In. mm	Model No.	A Max. In. mm	B ± 0.031 (0.79) In. mm											
STANDARD GLASS DIELECTRIC																					
0.8 4.5	750	J	500	GGL4R500	*PC42J4R5	0.656 16.66	0.500 12.70	GGV4R500	0.422 10.72	0.250 6.35	0.8 8.5	1250	J	500	GGL8R500	*PC42J8R5	0.906 23.01	0.703 17.86	GGV8R500	0.641 16.28	0.438 11.13
0.8 12.0	1250	H	500	GGL12000	*PC42H120	1.109 28.17	0.844 21.44	GGV12000	0.859 21.82	0.625 15.88	0.8 18.0	1250	H	500	GGL18000	*PC42H180	1.359 34.52	1.016 25.81	GGV18000	1.109 28.17	0.875 22.23
0.8 30.0	1250	H	350	GGL30000	*PC42H300	1.953 49.61	1.469 37.31	GGV30000	1.703 43.26	1.375 34.93											
HI-RANGE GLASS DIELECTRIC																					
0.8 5.5	750	J	1000	GHL5R500	PC52J5R5	0.656 16.66	0.500 12.70	GHV5R500	0.422 10.72	0.250 6.35	0.8 11.0	1250	J	900	GHL11000	PC52J110	0.906 23.01	0.703 17.86	GHV11000	0.641 16.28	0.438 11.13
0.8 16.0	1250	H	800	GHL16000	PC52H160	1.109 28.17	0.844 21.44	GHV16000	0.859 21.82	0.625 15.88	0.8 23.0	1250	H	700	GHL23000	PC52H230	1.359 34.52	1.016 25.81	GHV23000	1.109 28.17	0.875 22.23
0.8 38.0	1250	H	500	GHL38000	PC52H380	1.953 49.61	1.469 37.31	GHV38000	1.703 43.26	1.375 34.93											
QUARTZ DIELECTRIC																					
0.6 1.8	750	Q	1500	GQL1R800	PC42Q1R8	0.656 16.66	0.500 12.70				0.6 5.5	1250	Q	1500	GQL5R500	PC42Q5R5	0.922 23.42	0.703 17.86			
0.6 9.5	1250	Q	1500	GQL9R500	PC42Q9R5	1.359 34.52	1.016 25.81														
0.8 16.0	1250	Q	1500	GQL16000	PC42Q160	1.953 49.61	1.469 37.31														

*These capacitors were listed in Military Specification MIL-C-14409B but do not appear in MIL-C-14409D.

MODIFICATIONS



No. 16
BASE LUG, SINGLE LEAD



No. 17
BASE LUG, DOUBLE LEAD

EXPANDED RANGE SEALED PRINTED CIRCUIT MOUNTING

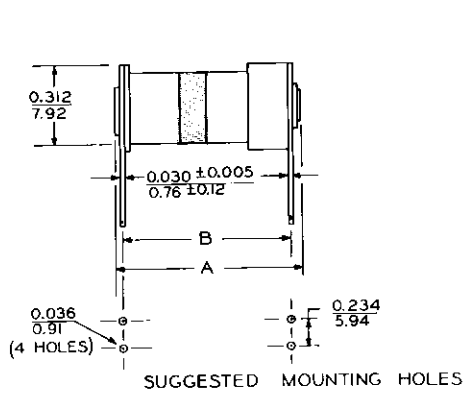

Figure 2C

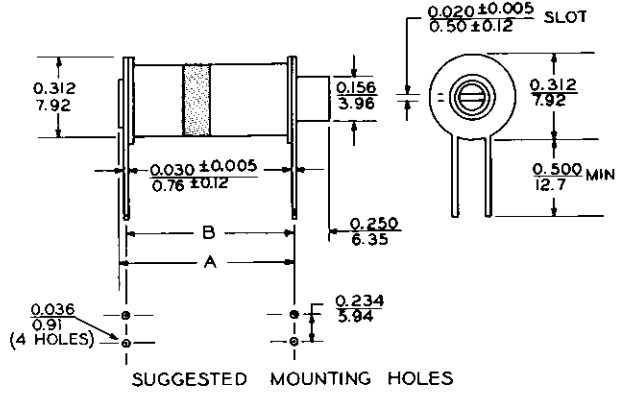

Figure 2D

Capacitance Range in pF Min. Max.	D-C Voltage Rating (Volts)	Temp. Char. (See Table)	Minimum Quality Factor Q	SEALED END STYLE (Fig. 2C)				COLLARED BUSHING STYLE (Fig. 2D)			
				Model No.	Mil Designation	A Max. In. mm	B ± 0.031 (0.79) In. mm	Model No.	A Max. In. mm	B ± 0.031 (0.79) In. mm	
STANDARD GLASS											
1.0 14.0	1000	G	500	GEL14000	*PC43G140	0.780 19.81	0.700 17.78	GEV14000	0.484 12.29	0.422 10.72	
1.0 28.0	1000	G	350	GEL28000	*PC43G280	1.020 25.91	0.940 23.88	GEV28000	0.734 18.64	0.672 17.07	
1.0 42.0	1000	G	250	GEL42000	*PC43G420	1.235 31.37	1.155 29.34	GEV42000	0.938 23.83	0.875 22.23	
1.0 60.0	1000	G	250	GEL60000	*PC43G600	1.480 37.59	1.400 35.56	GEV60000	1.188 30.18	1.125 28.58	
1.0 90.0	1000	G	250	GEL90000	*PC43G900	2.080 52.83	2.000 50.80	GEV90000	1.781 45.24	1.734 44.04	
HI-RANGE GLASS											
1.0 16.0	1000	G	750	GFL16000	PC43G160	0.780 19.81	0.700 17.78	GFV16000	0.484 12.29	0.422 10.72	
1.0 36.0	1000	G	550	GFL36000	PC43G360	1.020 25.91	0.940 23.88	GFV36000	0.734 18.64	0.672 17.07	
1.0 52.0	1000	G	350	GFL52000	PC43G520	1.235 31.37	1.155 29.34	GFV52000	0.938 23.83	0.875 22.23	
1.0 75.0	1000	G	250	GFL75000	PC43G750	1.480 37.59	1.400 35.56	GFV75000	1.188 30.18	1.125 28.58	
1.0 120.0	1000	G	250	GFL12100	PC43G121	2.080 52.83	2.000 50.80	GFV12100	1.781 45.24	1.734 44.04	

*These capacitors were listed in Military Specification MIL-C-14409B but do not appear in MIL-C-14409D.

NOTE: Capacitance increases up to 0.5 pF on vertical modifications due to position of leads alongside capacitor body.



PANEL MOUNTING



Figure 3A

SEALED PANEL MOUNTING



Figure 3B

Capacitance Range in pF Min. Max.	D-C Voltage Rating (Volts)	Min. Quality Factor Q	Temp. Char. (See Table)	Model No. Figure 3A	Mil Designation	A	
						+0.047, -0.031 (+1.19, -0.79) In. mm	
STANDARD GLASS							
0.8 4.5	750	500	J	GGP4R500	*PC40J4R5	0.297 7.54	
0.8 8.5	750	500	J	GGP8R500	*PC40J8R5	0.547 13.89	
0.8 12.0	750	500	H	GGP12000	*PC40H120	0.750 19.05	
0.8 18.0	750	500	H	GGP18000	*PC40H180	0.984 24.99	
0.8 30.0	750	350	H	GGP30000	*PC40H300	1.594 40.49	
HI-RANGE GLASS							
0.8 5.5	750	1000	J	GHP5R500	PC50J5R5	0.297 7.54	
0.8 11.0	750	900	J	GHP11000	PC50J110	0.547 13.89	
0.8 16.0	750	800	H	GHP16000	PC50H160	0.750 19.05	
0.8 23.0	750	700	H	GHP23000	PC50H230	0.984 24.99	
0.8 38.0	750	500	H	GHP38000	PC50H380	1.594 40.49	
QUARTZ							
0.6 1.8	750	1500	Q	GQP1R800	PC40Q1R8	0.297 7.54	
0.6 5.5	750	1500	Q	GQP5R500	PC40Q5R5	0.547 13.89	
0.6 9.5	750	1500	Q	GQP9R500	PC40Q9R5	0.984 24.99	
0.8 16.0	750	1500	Q	GQP16000	PC40Q160	1.594 40.49	

Capacitance Range in pF Min. Max.	D-C Voltage Rating (Volts)	Min. Quality Factor Q	Temp. Char. (See Table)	Model No. Figure 3B	Mil Designation	Length A ± 0.031 (0.79) In. mm	
						STANDARD GLASS	
0.8 4.5	750	500	J	GGR4R500	*PC38J4R5	0.359 9.12	
0.8 8.5	1250	500	J	GGR8R500	*PC38J8R5	0.594 15.09	
0.8 12.0	1250	500	H	GGR12000	*PC38H120	0.812 20.62	
0.8 18.0	1250	500	H	GGR18000	*PC38H180	1.062 26.97	
0.8 30.0	1250	350	H	GGR30000	*PC38H300	1.656 42.06	
HI-RANGE GLASS							
0.8 5.5	750	1000	J	GHR5R500	PC48J5R5	0.359 9.12	
0.8 11.0	1250	900	J	GHR11000	PC48J110	0.594 15.09	
0.8 16.0	1250	800	H	GHR16000	PC48H160	0.812 20.62	
0.8 23.0	1250	700	H	GHR23000	PC48H230	1.062 26.97	
0.8 38.0	1250	500	H	GHR38000	PC48H380	1.656 42.06	
QUARTZ							
0.6 1.8	750	1500	Q	GQR1R800	PC38Q1R8	0.359 9.12	
0.6 5.5	1250	1500	Q	GQR5R500	PC38Q5R5	0.625 15.88	
0.6 9.5	1250	1500	Q	GQR9R500	PC38Q9R5	1.062 26.97	
0.8 16.0	1250	1500	Q	GQR16000	PC38Q160	1.656 42.06	

*These capacitors were listed in Military Specification MIL-C-14409B but do not appear in MIL-C-14409D.

MODIFICATIONS

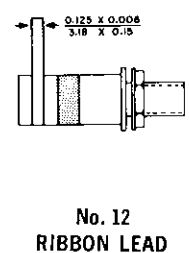
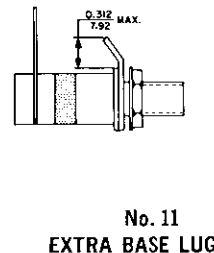
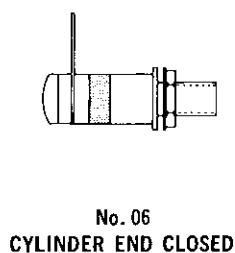
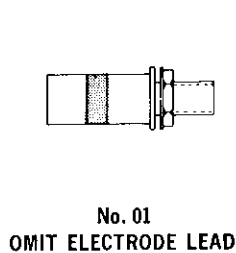

EXPANDED RANGE PANEL MOUNTING



Figure 3C

EXPANDED RANGE SEALED PANEL MOUNTING



Figure 3D

Capacitance Range in pF	D-C Voltage Rating (Volts)	Minimum Quality Factor Q	Temp. Char. (See Table)	Model No. Figure 3C	A ± 0.031 (0.79)	
Min. Max.					In.	mm
STANDARD GLASS DIELECTRIC						
1.2	10.0	500	Y	GSG006	0.266	6.76
1.0	14.0	750	G	GEP14000	0.375	9.53
1.0	28.0	750	G	GEP28000	0.609	15.47
1.0	42.0	750	G	GEP42000	0.828	21.03
1.0	60.0	750	G	GEP60000	1.078	27.38
1.0	90.0	750	G	GEP90000	1.672	42.47
HI-RANGE GLASS DIELECTRIC						
1.2	16.0	500	Y	GSG007	0.312	7.92
1.0	16.0	750	G	GFP16000	0.375	9.53
1.0	36.0	750	G	GFP36000	0.609	15.47
1.0	52.0	750	G	GFP52000	0.828	21.03
1.0	75.0	750	G	GFP75000	1.078	27.38
1.0	120.0	750	G	GFP12100	1.672	42.47

Capacitance Range in pF	D-C Voltage Rating (Volts)	Min. Quality Factor Q	Temp. Char. (See Table)	Model No. Figure 3D	Mil Designation	Length A ± 0.031 (0.79)	
Min. Max.						In.	mm
STANDARD GLASS							
1.0	14	1000	500	G	GER14000	*PC39G140	0.469 11.91
1.0	28	1000	350	G	GER28000	*PC39G280	0.703 17.86
1.0	42	1000	250	G	GER42000	*PC39G420	0.922 23.42
1.0	60	1000	250	G	GER60000	*PC39G600	1.172 29.77
1.0	90	1000	250	G	GER90000	*PC39G900	1.766 44.86
HI-RANGE GLASS							
1.0	16	1000	750	G	GFR16000	PC39G160	0.469 11.91
1.0	36	1000	550	G	GFR36000	PC39G360	0.703 17.86
1.0	52	1000	350	G	GFR52000	PC39G520	0.922 23.42
1.0	75	1000	250	G	GFR75000	PC39G750	1.172 29.77
1.0	120	1000	250	G	GFR12100	PC39G121	1.766 44.86

*These capacitors were listed in Military Specification MIL-C-14409B but do not appear in MIL-C-14409D.



No. 13
WELDABLE LEAD



No. 14
TURRET CAP



No. 15
DOUBLE LEADS



No. 30
INSULATED NYLON BUSHING

EXTENDED-SCREW, 1/4" DIA. MOUNTING BUSHING

SPECIFICATIONS

Operating Temperature Range:

-55°C to +125°C (Glass)
-55°C to +150°C (Quartz)

Voltage Rating: 750 Volts D-C

Wire Size:

No. 22 AWG
Except GGW3R000
No. 24 AWG



TYPES GGW, GHW, GSG904 THRU 906

TYPES GQW, GSG900 THRU 903, AND GSG907 THRU 910

Cap. Range in pF		Min. Q at 20 MHz	Temp. Coeff. in ppm/°C	Model No.	Length		Screw Extension	
Min.	Max.				A ± .031	mm ± 0.79	B Max.	mm
STANDARD GLASS								
0.5	3.0	500	± 50	GGW3R000	0.484	12.29	0.625	15.88
0.8	8.5	500	± 75	GGW8R500	0.578	14.68	0.625	15.88
0.7	9.0	500	± 75	GGW9R000	0.656	16.66	0.656	16.66
0.8	12.0	500	± 100	GGW12000	0.765	19.43	0.750	19.05
0.8	18.0	500	± 100	GGW18000	1.000	25.40	0.843	21.41
0.8	30.0	500	± 100	GGW30000	1.594	40.49	1.141	28.98
HI-RANGE GLASS								
0.5	4.5	1000	± 100	GHW4R500	0.484	12.29	0.625	15.88
0.8	11.0	900	± 100	GHW11000	0.578	14.68	0.625	15.88
0.8	13.0	900	± 100	GHW13000	0.609	15.47	0.625	15.88
0.8	17.0	800	± 100	GHW17000	0.765	19.43	0.750	19.05
1.0	24.0	700	± 100	GHW24000	1.000	25.40	0.812	20.62
1.0	40.0	500	± 100	GHW40000	1.594	40.49	1.125	28.58
STANDARD GLASS — SPECIAL TEMP. COEFF.*								
0.7	9.0	500	+400 ± 100	GSG904	0.656	16.66	0.797	20.24
0.8	18.0	500	+400 ± 100	GSG905	1.000	25.40	0.938	23.83
0.8	30.0	500	+400 ± 100	GSG906	1.594	40.49	1.250	31.75
QUARTZ (C = 0.250 DIA. TUBE)								
0.6	5.5	1500	+50, -0	GQW5R500	0.563	14.30	0.765	19.43
0.6	9.5	1500	+50, -0	GQW9R500	1.000	25.40	0.891	22.63
0.8	16.0	1500	+50, -0	GQW16000	1.594	40.49	1.250	31.75
QUARTZ (C = 0.250 DIA. TUBE)*								
0.7	4.5	1500	+50, -0	GSG907	0.438	11.13	0.546	13.87
0.6	6.0	1500	+50, -0	GSG908	0.625	15.88	0.906	23.01
0.8	10.0	1500	+50, -0	GSG909	1.000	25.40	0.891	22.63
9.0	21.0	1500	+50, -0	GSG910	1.594	40.49	1.000	25.40
STANDARD GLASS (C = 0.250 DIA. TUBE)*								
0.7	9.0	500	+0, -150	GSG900	0.656	16.66	0.765	19.43
0.6	14.0	500	+0, -150	GSG901	1.000	25.40	1.000	25.40
0.8	18.0	500	+0, -150	GSG902	1.000	25.40	0.953	24.21
0.8	30.0	500	+0, -150	GSG903	1.594	40.49	1.250	31.75

*The "GSG" model prefix signifies a special design. Part numbers for these devices are assigned sequentially and are not in accordance with the standard part numbering system.

MINIATURE SPLIT STATOR CAPACITORS

Piston adjustment varies capacitance simultaneously from each plate to bushing and from plate to plate for use in push-pull circuits and similar networks.

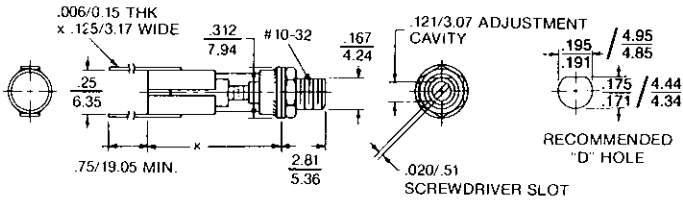

C₁ = Capacitance of Electrode Band 1 to Ground.
 C₂ = Capacitance of Electrode Band 2 to Ground.
 C₃ = Capacitance of Electrode Band 1 to Electrode Band 2.

Panel Mounting Model. For other configurations, contact factory.

Model No.	Cap. Range (pF)				K ± 0.031/0.79	
	Plate to Bushing		Plate to Plate		in.	mm
JFD-SP86GY	0.8	4.2	0.8	2.0	.547	13.89
JFD-SP87GY	0.8	9.0	1.5	4.5	1.000	25.40
JFD-SP88GY	1.0	14.0	2.0	7.0	1.609	40.87

MINIATURE DIFFERENTIAL CAPACITORS

Piston adjustment increases capacitance of one gang while capacitance of other gang decreases.

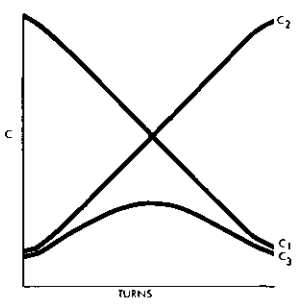
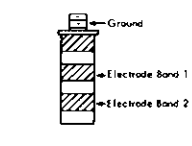
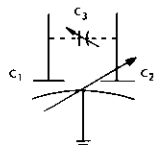
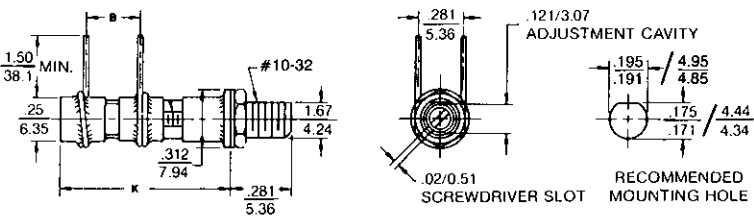

C₁ = Capacitance of Electrode Band 1 to Ground.
 C₂ = Capacitance of Electrode Band 2 to Ground.
 C₃ = Capacitance of Electrode Band 1 to Electrode Band 2.

Panel Mounting Model. For other configurations, contact factory.

Model No.	Sect.	Cap. Range (pF)		Typical (pF) Crossover	B ± .024/0.62		K ± .031/0.79		Wire Dia.	
		Min.	Max.		in.	mm	in.	mm	in.	mm
JFD-DC411Y	Sect. 1	0.7	3.0	2.3	.094	2.39	.312	7.92	.016	.41
	Sect. 2	2.0	3.0							
JFD-DC413Y	Sect. 1	1.0	8.0	5.0	.219	5.56	.547	13.89	.020	.51
	Sect. 2	3.0	8.0							
JFD-DC414Y	Sect. 1	1.0	12.0	6.8	.312	7.92	.750	19.05	.025	.64
	Sect. 2	3.5	12.0							
JFD-DC416Y	Sect. 1	1.5	16.0	9.2	.406	10.31	.937	23.80	.025	.64
	Sect. 2	4.0	11.0							
JFD-DC419Y	Sect. 1	2.0	26.0	15.2	.656	16.66	1.437	36.50	.025	.64
	Sect. 2	6.0	28.0							

Sect. #1: Base to end electrode
 Sect. #2: Base to center electrode

NOTES:

- TCC = 0 ± 100 ppm/°C; -55°C to +125°C
- Q @ 20 MHz: 500 min.
- Adjust torque: 1-10 oz.-in.
- Working Voltage Rating: 500 VDC
- Drift = 0.2% or 0.04 pF
- IR = 10⁹ MΩ

Surface Mount Glass PISTONCAP®

Vertical and Horizontal Mount Types

Available in Standard and Extended Range Models

VERTICAL MOUNT TYPES

EXTERNAL ELECTRODE

Capacitance Range in pF		D-C Voltage Rating (Volts)	Temp. Char. (See Table)	Minimum Quality Factor Q	A max		Unsealed Model No. (See Note 2)	Sealed Model No.
min	max				in	mm		
1.3	4.5 5.5	750	J	500 1000	0.383	9.73	GGN4R531 GHN5R531	GGV4R531 GHV5R531
1.3	8.5 11.0	750	J	500 900	0.633	16.1	GGN8R531 GHN11031	GGV8R531 GHV11031
1.3	12.0 16.0	750	H	500 800	0.837	21.3	GGN12031 GHN16031	GGV12031 GHV16031
1.3	18.0 23.0	750	H	500 700	1.071	27.2	GGN18031 GHN23031	GGV18031 GHV23031

EMBEDDED ELECTRODE

Capacitance Range in pF		D-C Voltage Rating (Volts)	Temp. Char. (See Table)	Minimum Quality Factor Q	A max		Unsealed Model No. (See Note 2)	Sealed Model No.
min	max				in	mm		
1.5	14.5 16.5	1000	G	500 750	0.462	11.7	GEN14031 GFN16031	GEV14031 GFV16031
1.5	28.5 36.5	1000	G	350 550	0.696	17.7	GEN28031 GFN36031	GEV28031 GFV36031



VERTICAL MOUNT

Notes:

1) Unsealed models: 0.120
3.05

Sealed models: 0.245
6.22

2) For an optional sealing cap to cover adjustment access on unsealed models, contact factory.

HORIZONTAL MOUNT TYPES

EXTERNAL ELECTRODE

Capacitance Range in pF		D-C Voltage Rating (Volts)	Temp. Char. (See Table)	Minimum Quality Factor Q	A max		Unsealed Model No. (See Note 2)	Sealed Model No.
min	max				in	mm		
0.8	8.5 11.0	750	J	500 900	0.673	17.1	GGN8R533 GHN11033	GGV8R533 GHV11033
0.8	12.0 16.0	750	H	500 800	0.877	22.3	GGN12033 GHN16033	GGV12033 GHV16033
0.8	18.0 23.0	750	H	500 700	1.111	28.2	GGN18033 GHN23033	GGV18033 GHV23033
0.8	30.0 38.0	750	H	350 500	1.720	43.7	GGN30033 GHN38033	GGV30033 GHV38033

EMBEDDED ELECTRODE

Capacitance Range in pF		D-C Voltage Rating (Volts)	Temp. Char. (See Table)	Minimum Quality Factor Q	A max		Unsealed Model No. (See Note 2)	Sealed Model No.
min	max				in	mm		
1.0	28.0 36.0	1000	G	350 550	0.736	18.7	GEN28033 GFN36033	GEV28033 GFV36033
1.0	42.0 52.0	1000	G	250 350	0.955	24.3	GEN42033 GFN52033	GEV42033 GFV52033
1.0	60.0 75.0	1000	G	250 250	1.205	30.6	GEN60033 GFN75033	GEV60033 GFV75033
1.0	90.0 120.0	1000	G	250 250	1.799	45.7	GEN90033 GFN12133	GEV90033 GFV12133



HORIZONTAL MOUNT

Notes:

1) Unsealed models: 0.120
3.05

Sealed models: 0.245
6.22

2) For an optional sealing cap to cover adjustment access on unsealed models, contact factory.

DIRECT TRAVERSE GLASS TRIMMERS

FEATURES

- Shortest sealed PISTONCAP®
- Designed to meet MIL-C-14409.
- Annular band and embedded band models.
- High Q.
- High self-resonant frequency.
- Surface mount or through-hole mount.
- O-ring seal protects (to 276 kPa, 40 psi) against dust, flux, moisture, solder and solvents.
- Direct traverse (non-rotating) piston.

SPECIFICATIONS

Operating Temperature Range: -55°C to 125°C
 Voltage Rating: 250 VDC
 Dielectric Withstanding Voltage: 500 VDC
 Insulation Resistance: 10⁶ Megohms min
 Torque: 36 to 360 g-cm (0.50 to 5.0 oz-in)
 Tuning Resolution:
 0.7 pF per turn for Annular Band
 2.7 pF per turn for Embedded Band



	Capacitance Range (pF)		TCC (ppm/°C)	Q min (1 MHz)	A max (in/mm)	Surface Mount Model No.	Through-hole Model No.
	min	max					
Annular Band Models	1.0	5.5	0 ± 50	1000	0.42/11	GDT5R531	GDT5R526
	1.0	8.5	0 ± 50	650	0.57/14	GDT8R531	GDT8R526
Embedded Band Models	1.5	10	0 ± 150	800	0.37/9.4	GDT10031	GDT10026
	1.5	20	0 ± 150	800	0.44/11	GDT20031	GDT20026
	1.5	30	0 ± 150	800	0.52/13	GDT30031	GDT30026
	1.5	40	0 ± 150	800	0.63/16	GDT40031	GDT40026



Note: For horizontal mounting configurations, contact factory.
 All dimensions are in / mm.
 Unless otherwise specified, the tolerance on all dimensions is ±0.005/0.1, except slot tolerance is ±0.002/0.05.

HIGH VOLTAGE TRIMMER (Quartz Dielectric)



Model No.	Capacitance Range (pF)	WVDC	Dielectric Strength VDC
JFD-VC99	0.8-10.0	5,000	10,000

- Notes:**
1. Operating Temp.: -55° C to +150° C
 2. Temp. coefficient: +25 ± 25 PPM/° C
 3. Q factor @ 20 MHz: 1500 min.
 4. Insulation Resistance: 10⁶ megohms

HIGH RF VOLTAGE TRIMMER (Quartz Dielectric)



Fig. 1

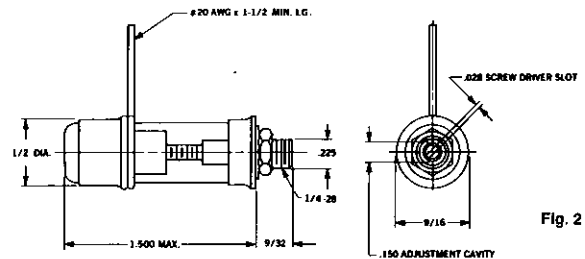

Fig. 2

Model No.	Capacitance Range (pF)	Operating RF voltage (measured for 1 min.) at 50% R.H. and 2 MHz	Fig.
JFD-VCJ1616M	0.5-5.0	3,100 v peak at +25° C 2,500 v peak at +200° C (superimposed on 2,500 VDC)	1
JFD-VCJ1616E	0.9-5.0	4,000 v peak at +25° C 3,500 v peak at +200° C (superimposed on 2,500 VDC)	2

- Notes:**
1. Operating Temp.: -55° C to +200° C
 2. Temp. coefficient: (-55 thru +150° C): ± 100 PPM/° C
 3. Dielectric strength: 10,000 VDC
 4. Q @ 1 MHz: 2000 min.
 5. Insulation Resistance (after 1 min. @ 500 VDC and 50/R.H.): 10⁶ megohms min.
 6. Suitable frequency range: 1 to 30 MHz.

STANDARD MODIFICATIONS

Mod. Suffix	Description of Modification	Availability on Models	Shown on Pages	Mod. Suffix	Description of Modification	Availability on Models	Shown on Pages
01	Omit Electrode Lead	Panel Mtg.	8, 9	22	Two Wire & Lug Vertical	PC Mtg.	4, 5, 6, 7
06	Cylinder End Closed	Open End Panel & PC	4, 5, 8	25	Turret Pin Cap & Two Wire Vertical	PC Mtg.	4, 5, 6, 7
11	Extra Base Lug	Panel Mtg.	8, 9	26	Turret Pin Cap & Lug Vertical	PC Mtg.	4, 5, 6, 7, 14
12	Ribbon Lead	Panel Mtg.	8, 9	27	Turret Pin Cap & One Wire Vertical	PC Mtg.	4, 5, 6, 7
13	Weldable Lead	Panel Mtg.	8, 9	30	Insulated Nylon Bushing	Panel Mtg.	8, 9
14	Turret Cap	Open End Panel Mtg.	8, 9	31	Vertical Surface Mount	PC Mtg.	12, 14
15	Double Leads	Panel Mtg.	8, 9	33	Horizontal Surface Mount	PC Mtg.	13
16	Base Lug, Single Lead	PC Mtg.	4, 5, 6, 7				
17	Base Lug, Double Leads	PC Mtg.	4, 5, 6, 7				
21	Four Wire Vertical	PC Mtg.	4, 5, 6, 7				

CUSTOM PISTONCAP® CAPACITOR DESIGNS

There are many possible design variations utilizing Pistoncap technology. The standard modifications given on pages 4 through 9 show the more popular design variations. In addition, dual electrode band models (differential) and split electrode band models (split stator) are shown below. Both styles are available in any of the standard or modified mechanical designs listed in the bulletin.

Pistoncaps are rated quite conservatively for both minimum and maximum capacitance. Therefore, units with a larger guaranteed range can be supplied on special order.

Shown at right is a variety of special leads, lugs, and combinations of leads and lugs available on Sprague-Goodman Pistoncap capacitors. These, in addition to other possibilities, afford the design engineer a wide selection of mounting and attachment for his packaging requirements.



NOTES ON MEASUREMENTS

1. Capacitance measured at 1 MHz \pm 100 kHz in a test fixture incorporating a guard provision.
2. Dielectric Strength: Twice Rated Voltage.
3. Dielectric strength measured at maximum rated capacitance.
4. Insulation Resistance: 10^6 Megohms at +25°C.
5. Insulation resistance at peak operating temperature: see table.
6. Insulation resistance measured at maximum rated capacitance with 500 \pm 50 volts applied for 1 minute.
7. Quality factor (Q) measured at 20 MHz \pm 200 kHz at maximum rated capacitance.
8. Temperature coefficient of capacitance measured at 1 MHz \pm 100 kHz at approximately 75% of maximum rated capacitance.
9. All measurements per MIL-C-14409D.
10. Driving torque: 1 to 10 ounce-inches.
11. Tolerance on dimensions: \pm 0.016 (\pm 0.41 mm) unless otherwise specified.

TEMPERATURE TABLE

Temp. Char.	Operating Temperature Range	Temp. Coefficient (ppm/°C)	Max. Drift	IR at Peak Temp. (MΩ)
G	- 55°C to + 125°C	\pm 150	\pm 0.5%	10^5
H	- 55°C to + 125°C	\pm 100	\pm 0.2% or 0.04pF	10^5
J	- 55°C to + 125°C	\pm 50	\pm 0.15% or 0.02pF	10^5
Q	- 55°C to + 150°C	+ 50, -0	\pm 0.10% or 0.01pF	10^6
Y	- 55°C to + 125°C	+ 75, \pm 75	\pm 0.5%	10^5



Sprague-Goodman Electronics, Inc.

1700 SHAMES DRIVE, WESTBURY, NY 11590

TEL: 516-334-8700 • FAX: 516-334-8771



Компания «ЭлектроПласт» предлагает заключение долгосрочных отношений при поставках импортных электронных компонентов на взаимовыгодных условиях!

Наши преимущества:

- Оперативные поставки широкого спектра электронных компонентов отечественного и импортного производства напрямую от производителей и с крупнейших мировых складов;
- Поставка более 17-ти миллионов наименований электронных компонентов;
- Поставка сложных, дефицитных, либо снятых с производства позиций;
- Оперативные сроки поставки под заказ (от 5 рабочих дней);
- Экспресс доставка в любую точку России;
- Техническая поддержка проекта, помощь в подборе аналогов, поставка прототипов;
- Система менеджмента качества сертифицирована по Международному стандарту ISO 9001;
- Лицензия ФСБ на осуществление работ с использованием сведений, составляющих государственную тайну;
- Поставка специализированных компонентов (Xilinx, Altera, Analog Devices, Intersil, Interpoint, Microsemi, Aeroflex, Peregrine, Syfer, Eurofarad, Texas Instrument, Miteq, Cobham, E2V, MA-COM, Hittite, Mini-Circuits, General Dynamics и др.);

Помимо этого, одним из направлений компании «ЭлектроПласт» является направление «Источники питания». Мы предлагаем Вам помощь Конструкторского отдела:

- Подбор оптимального решения, техническое обоснование при выборе компонента;
- Подбор аналогов;
- Консультации по применению компонента;
- Поставка образцов и прототипов;
- Техническая поддержка проекта;
- Защита от снятия компонента с производства.



Как с нами связаться

Телефон: 8 (812) 309 58 32 (многоканальный)

Факс: 8 (812) 320-02-42

Электронная почта: org@eplast1.ru

Адрес: 198099, г. Санкт-Петербург, ул. Калинина, дом 2, корпус 4, литера А.