



## N-Channel Enhancement-Mode Vertical DMOS FETs

### Features

- ▶ Free from secondary breakdown
- ▶ Low power drive requirement
- ▶ Ease of paralleling
- ▶ Low  $C_{ISS}$  and fast switching speeds
- ▶ Excellent thermal stability
- ▶ Integral source-drain diode
- ▶ High input impedance and high gain

### Applications

- ▶ Motor controls
- ▶ Converters
- ▶ Amplifiers
- ▶ Switches
- ▶ Power supply circuits
- ▶ Drivers (relays, hammers, solenoids, lamps, memories, displays, bipolar transistors, etc.)

### General Description

The Supertex VN0550 is an enhancement-mode (normally-off) transistor that utilizes a vertical DMOS structure and Supertex's well-proven silicon-gate manufacturing process. This combination produces a device with the power handling capabilities of bipolar transistors, and the high input impedance and positive temperature coefficient inherent in MOS devices. Characteristic of all MOS structures, this device is free from thermal runaway and thermally-induced secondary breakdown.

Supertex's vertical DMOS FETs are ideally suited to a wide range of switching and amplifying applications where very low threshold voltage, high breakdown voltage, high input impedance, low input capacitance, and fast switching speeds are desired.

### Ordering Information

| Device | Package    | Wafer / Die Options       |                              |                           |
|--------|------------|---------------------------|------------------------------|---------------------------|
|        | TO-92      | NW<br>(Die in wafer form) | NJ<br>(Die on adhesive tape) | ND<br>(Die in wafer pack) |
| VN0550 | VN0550N3-G | VN1550NW                  | VN1550NJ                     | VN1550ND                  |

For packaged products, -G indicates package is RoHS compliant ('Green'). Devices in Wafer / Die form are RoHS compliant ('Green'). Refer to Die Specification VF15 for layout and dimensions.

### Product Summary

| $BV_{DSS}/BV_{DGS}$<br>(V) | $R_{DS(ON)}$<br>(max)<br>( $\Omega$ ) | $I_{D(ON)}$<br>(min)<br>(mA) |
|----------------------------|---------------------------------------|------------------------------|
| 500                        | 60                                    | 150                          |

### Absolute Maximum Ratings

| Parameter                         | Value                             |
|-----------------------------------|-----------------------------------|
| Drain-to-source voltage           | $BV_{DSS}$                        |
| Drain-to-gate voltage             | $BV_{DGS}$                        |
| Gate-to-source voltage            | $\pm 20V$                         |
| Operating and storage temperature | $-55^{\circ}C$ to $+150^{\circ}C$ |

Absolute Maximum Ratings are those values beyond which damage to the device may occur. Functional operation under these conditions is not implied. Continuous operation of the device at the absolute rating level may affect device reliability. All voltages are referenced to device ground.

### Pin Configuration

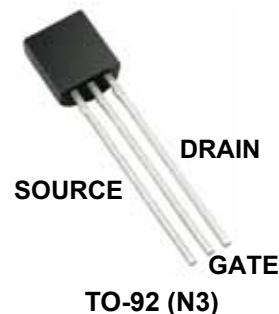

### Product Marking



YY = Year Sealed  
 WW = Week Sealed  
 \_\_\_\_\_ = "Green" Packaging

Package may or may not include the following marks: Si or

**TO-92 (N3)**

### Thermal Characteristics

| Package | $I_D$<br>(continuous) <sup>†</sup><br>(mA) | $I_D$<br>(pulsed)<br>(mA) | Power Dissipation<br>@ $T_c = 25^\circ\text{C}$<br>(W) | $\theta_{jc}$<br>( $^\circ\text{C/W}$ ) | $\theta_{ja}$<br>( $^\circ\text{C/W}$ ) | $I_{DR}^{\dagger}$<br>(mA) | $I_{DRM}$<br>(mA) |
|---------|--|---------------------------|--|---|---|----------------------------|-------------------|
| TO-92   | 50   | 250                       | 1.0  | 125                                     | 170                                     | 50                         | 250               |

**Notes:**

<sup>†</sup>  $I_D$  (continuous) is limited by max rated  $T_J$ .

### Electrical Characteristics ( $T_A = 25^\circ\text{C}$ unless otherwise specified)

| Sym                 | Parameter                                  | Min | Typ  | Max  | Units                | Conditions  |
|---------------------|--|-----|------|------|----------------------|---|
| $BV_{DSS}$          | Drain-to-source breakdown voltage          | 500 | -    | -    | V                    | $V_{GS} = 0V, I_D = 1.0mA$  |
| $V_{GS(th)}$        | Gate threshold voltage                     | 2.0 | -    | 4.0  | V                    | $V_{GS} = V_{DS}, I_D = 1.0mA$  |
| $\Delta V_{GS(th)}$ | Change in $V_{GS(th)}$ with temperature    | -   | -3.8 | -5.0 | mV/ $^\circ\text{C}$ | $V_{GS} = V_{DS}, I_D = 1.0mA$  |
| $I_{GSS}$           | Gate body leakage current                  | -   | -    | 100  | nA                   | $V_{GS} = \pm 20V, V_{DS} = 0V$   |
| $I_{DSS}$           | Zero gate voltage drain current            | -   | -    | 10   | $\mu\text{A}$        | $V_{GS} = 0V, V_{DS} = \text{Max Rating}$                               |
|                     |  | -   | -    | 1.0  | mA                   | $V_{DS} = 0.8 \text{ Max Rating}, V_{GS} = 0V, T_A = 125^\circ\text{C}$ |
| $I_{D(ON)}$         | On-state drain current                     | -   | 100  | -    | mA                   | $V_{GS} = 5.0V, V_{DS} = 25V$   |
|                     |  | 150 | 350  | -    |                      | $V_{GS} = 10V, V_{DS} = 25V$  |
| $R_{DS(ON)}$        | Static drain-to-source on-state resistance | -   | 45   | -    | $\Omega$             | $V_{GS} = 5.0V, I_D = 50mA$   |
|                     |  | -   | 40   | 60   |                      | $V_{GS} = 10V, I_D = 50mA$  |
| $\Delta R_{DS(ON)}$ | Change in $R_{DS(ON)}$ with temperature    | -   | 1.0  | 1.7  | %/ $^\circ\text{C}$  | $V_{GS} = 10V, I_D = 50mA$  |
| $G_{FS}$            | Forward transconductance                   | 50  | 100  | -    | mmho                 | $V_{DS} = 25V, I_D = 50mA$  |
| $C_{ISS}$           | Input capacitance                          | -   | 45   | 55   | pF                   | $V_{GS} = 0V, V_{DS} = 25V, f = 1.0MHz$                                 |
| $C_{OSS}$           | Common source output capacitance           | -   | 8.0  | 10   |                      |   |
| $C_{RSS}$           | Reverse transfer capacitance               | -   | 2.0  | 5.0  |                      |   |
| $t_{d(ON)}$         | Turn-on time                               | -   | -    | 10   | ns                   | $V_{DD} = 25V, I_D = 150mA, R_{GEN} = 25\Omega$                         |
| $t_r$               | Rise time                                  | -   | -    | 15   |                      |   |
| $t_{d(OFF)}$        | Turn-off time                              | -   | -    | 10   |                      |   |
| $t_f$               | Fall time                                  | -   | -    | 10   |                      |   |
| $V_{SD}$            | Diode forward voltage drop                 | -   | 0.8  | -    | V                    | $V_{GS} = 0V, I_{SD} = 500mA$   |
| $t_{rr}$            | Reverse recovery time                      | -   | 300  | -    | ns                   | $V_{GS} = 0V, I_{SD} = 500mA$   |

**Notes:**

1. All D.C. parameters 100% tested at  $25^\circ\text{C}$  unless otherwise stated. (Pulse test:  $300\mu\text{s}$  pulse, 2% duty cycle.)
2. All A.C. parameters sample tested.

### Switching Waveforms and Test Circuit

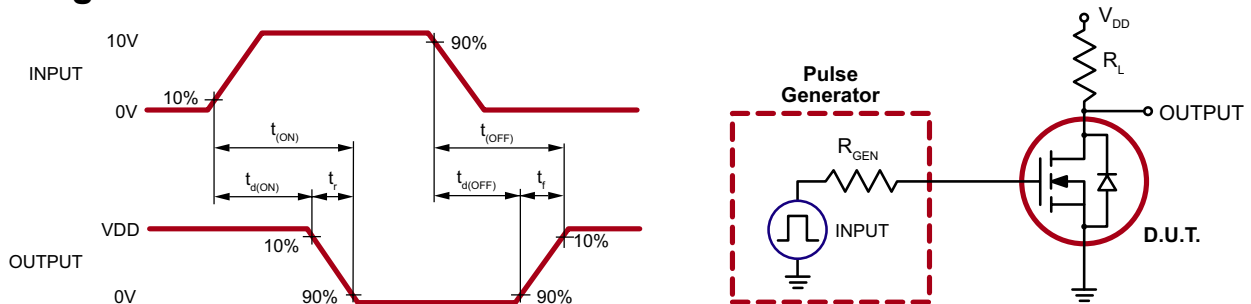

# Typical Performance Curves

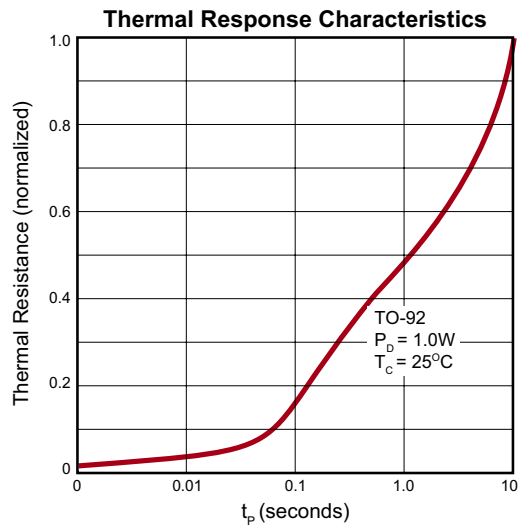
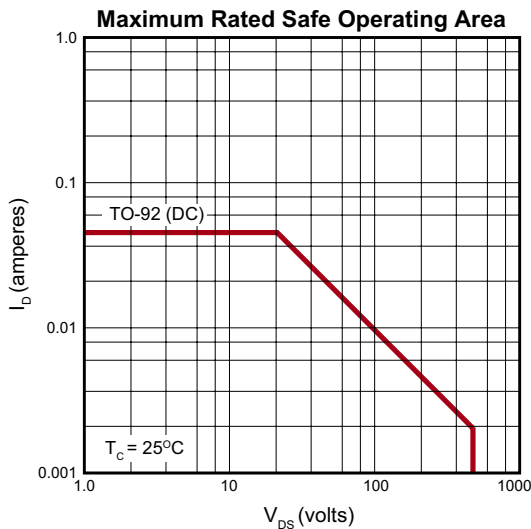
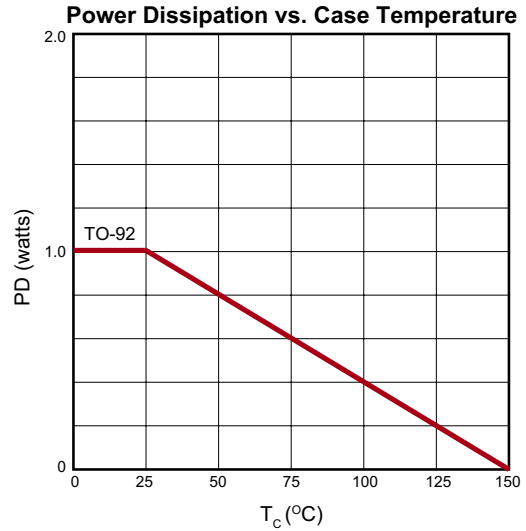
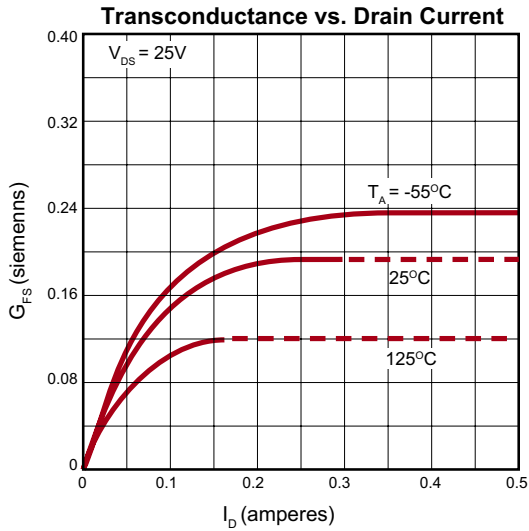
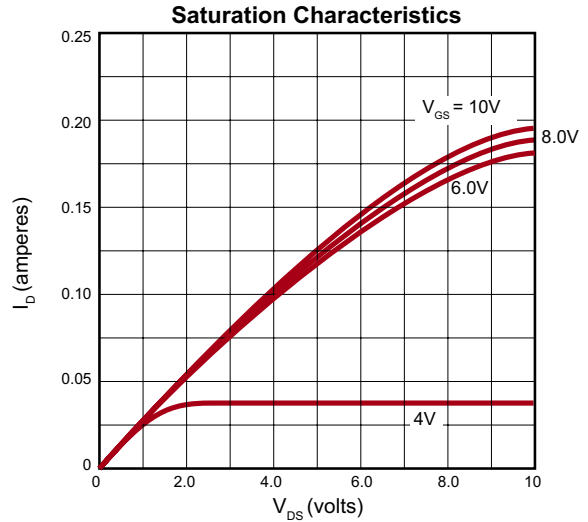
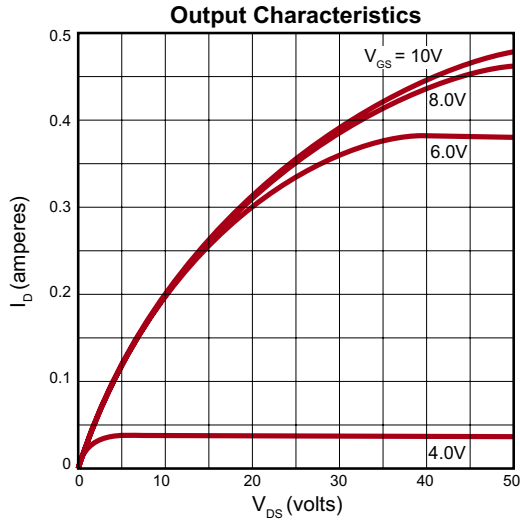

Typical Performance Curves (cont.)

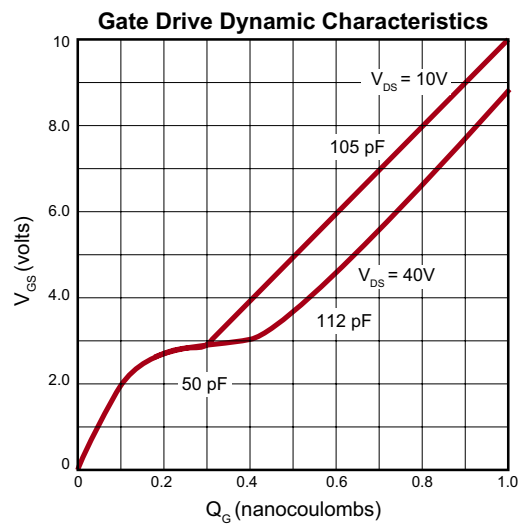
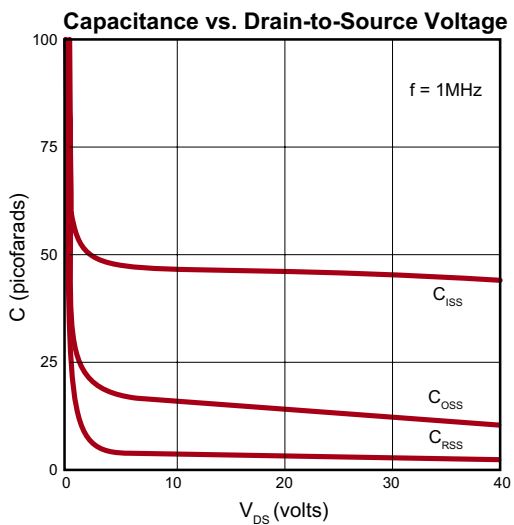
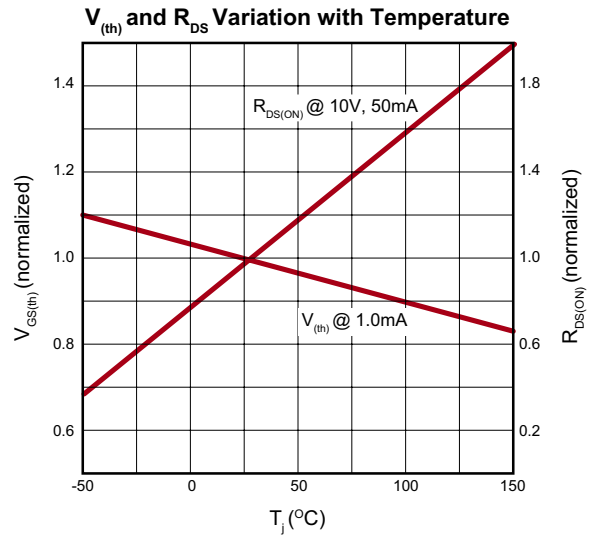
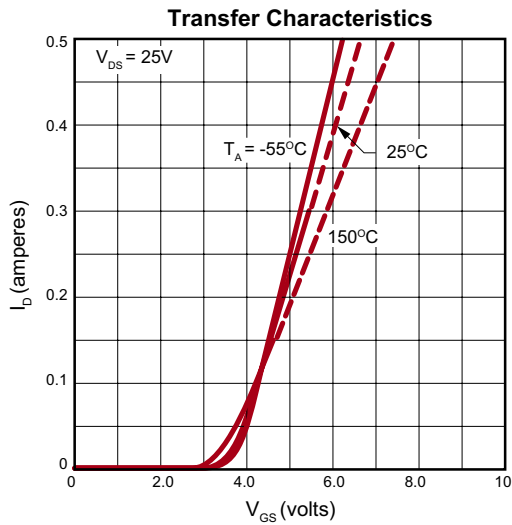
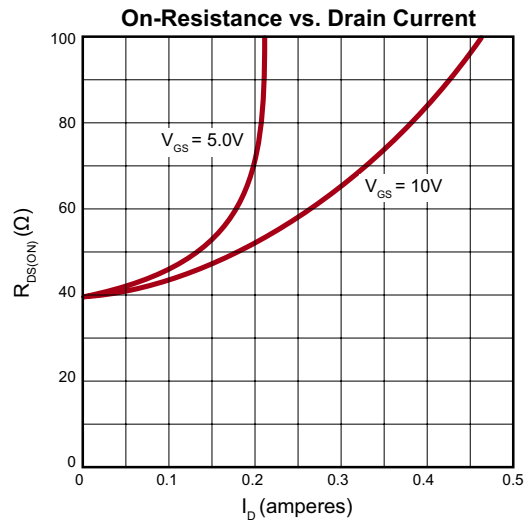
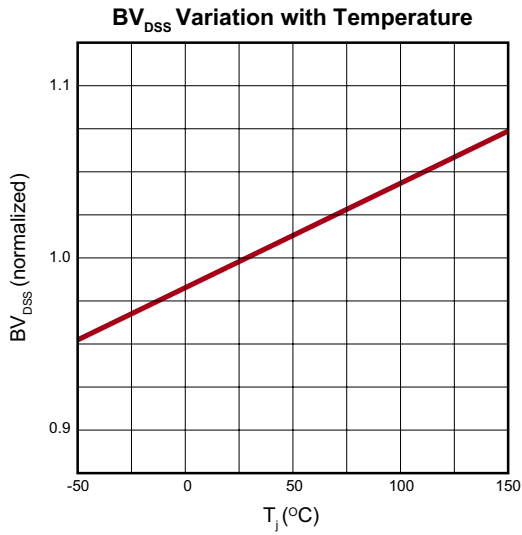

### 3-Lead TO-92 Package Outline (N3)

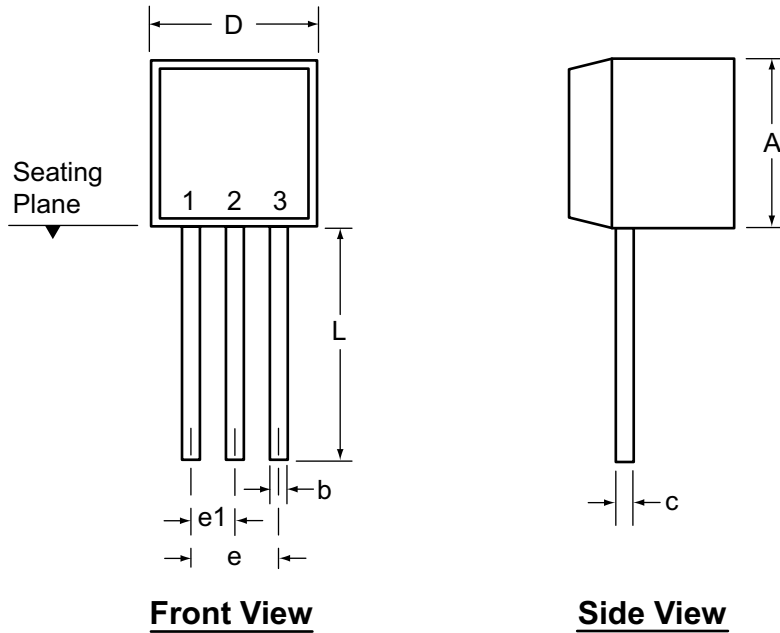

| Symbol                 |     | A    | b                 | c                 | D    | E    | E1   | e    | e1   | L     |
|------------------------|-----|------|-------------------|-------------------|------|------|------|------|------|-------|
| Dimensions<br>(inches) | MIN | .170 | .014 <sup>†</sup> | .014 <sup>†</sup> | .175 | .125 | .080 | .095 | .045 | .500  |
|                        | NOM | -    | -                 | -                 | -    | -    | -    | -    | -    | -     |
|                        | MAX | .210 | .022 <sup>†</sup> | .022 <sup>†</sup> | .205 | .165 | .105 | .105 | .055 | .610* |

JEDEC Registration TO-92.

\* This dimension is not specified in the JEDEC drawing.

† This dimension differs from the JEDEC drawing.

Drawings not to scale.

Supertex Doc.#: DSPD-3TO92N3, Version E041009.

(The package drawing(s) in this data sheet may not reflect the most current specifications. For the latest package outline information go to <http://www.supertex.com/packaging.html>.)

**Supertex inc.** does not recommend the use of its products in life support applications, and will not knowingly sell them for use in such applications unless it receives an adequate "product liability indemnification insurance agreement." **Supertex inc.** does not assume responsibility for use of devices described, and limits its liability to the replacement of the devices determined defective due to workmanship. No responsibility is assumed for possible omissions and inaccuracies. Circuitry and specifications are subject to change without notice. For the latest product specifications refer to the **Supertex inc.** (website: <http://www.supertex.com>)



Компания «ЭлектроПласт» предлагает заключение долгосрочных отношений при поставках импортных электронных компонентов на взаимовыгодных условиях!

Наши преимущества:

- Оперативные поставки широкого спектра электронных компонентов отечественного и импортного производства напрямую от производителей и с крупнейших мировых складов;
- Поставка более 17-ти миллионов наименований электронных компонентов;
- Поставка сложных, дефицитных, либо снятых с производства позиций;
- Оперативные сроки поставки под заказ (от 5 рабочих дней);
- Экспресс доставка в любую точку России;
- Техническая поддержка проекта, помощь в подборе аналогов, поставка прототипов;
- Система менеджмента качества сертифицирована по Международному стандарту ISO 9001;
- Лицензия ФСБ на осуществление работ с использованием сведений, составляющих государственную тайну;
- Поставка специализированных компонентов (Xilinx, Altera, Analog Devices, Intersil, Interpoint, Microsemi, Aeroflex, Peregrine, Syfer, Eurofarad, Texas Instrument, Miteq, Cobham, E2V, MA-COM, Hittite, Mini-Circuits, General Dynamics и др.);

Помимо этого, одним из направлений компании «ЭлектроПласт» является направление «Источники питания». Мы предлагаем Вам помощь Конструкторского отдела:

- Подбор оптимального решения, техническое обоснование при выборе компонента;
- Подбор аналогов;
- Консультации по применению компонента;
- Поставка образцов и прототипов;
- Техническая поддержка проекта;
- Защита от снятия компонента с производства.



#### Как с нами связаться

**Телефон:** 8 (812) 309 58 32 (многоканальный)

**Факс:** 8 (812) 320-02-42

**Электронная почта:** [org@eplast1.ru](mailto:org@eplast1.ru)

**Адрес:** 198099, г. Санкт-Петербург, ул. Калинина, дом 2, корпус 4, литера А.