

# Coupled Inductors MSD1514

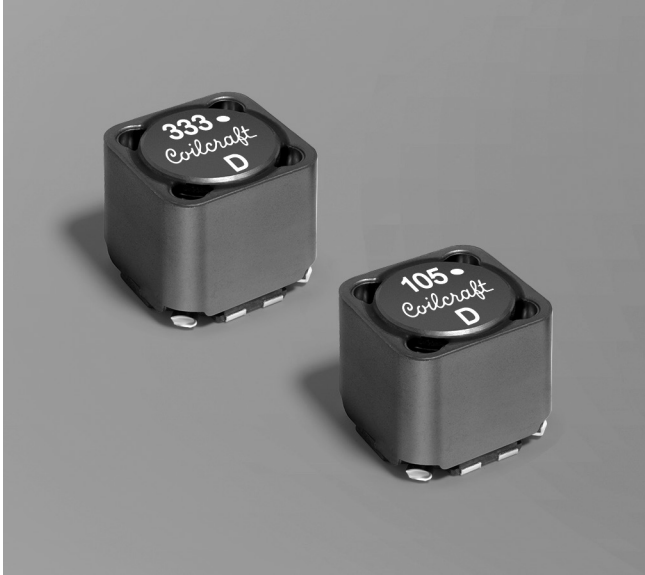

**Core material** Ferrite  
**Core and winding loss** [Go to online calculator](#)  
**Environmental** RoHS compliant, halogen free  
**Terminations** RoHS compliant matte tin over nickel over phos bronze. Other terminations available at additional cost.  
**Weight:** 9.0 – 11.8 g  
**Ambient temperature**  $-40^{\circ}\text{C}$  to  $+85^{\circ}\text{C}$  with ( $40^{\circ}\text{C}$  rise) Irms current.  
**Maximum part temperature**  $+125^{\circ}\text{C}$  (ambient + temp rise).  
**Storage temperature** Component:  $-40^{\circ}\text{C}$  to  $+125^{\circ}\text{C}$ .  
 Tape and reel packaging:  $-40^{\circ}\text{C}$  to  $+80^{\circ}\text{C}$   
**Winding-to-winding isolation** 500 Vrms, one minute  
**Resistance to soldering heat** Max three 40 second reflows at  $+260^{\circ}\text{C}$ , parts cooled to room temperature between cycles  
**Moisture Sensitivity Level (MSL)** 1 (unlimited floor life at  $<30^{\circ}\text{C}$  / 85% relative humidity)  
**Failures in Time (FIT) / Mean Time Between Failures (MTBF)**  
 38 per billion hours / 26,315,789 hours, calculated per Telcordia SR-332  
**Packaging** 175/13" reel; Plastic tape: 32 mm wide, 0.5 mm thick, 24 mm pocket spacing, 14.3 mm pocket depth  
**PCB washing** Tested with pure water or alcohol only. For other solvents, see [Doc787\\_PCB\\_Washing.pdf](#).

- Excellent coupling coefficient ( $k \geq 0.97$ )
- Ideal for use in a variety of circuits including flyback, multi-output buck, SEPIC, Zeta, and Ćuk.
- High inductance, high efficiency and excellent current handling.
- In SEPIC topologies, the required inductance for each winding is half the value needed for two separate inductors, allowing selection of a part with lower DCR and higher current handling.

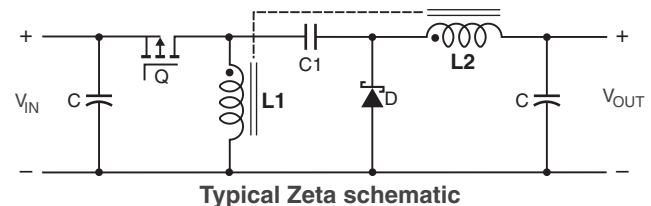
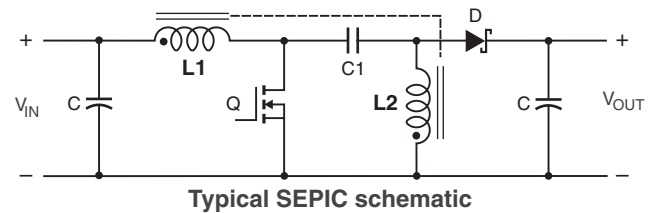
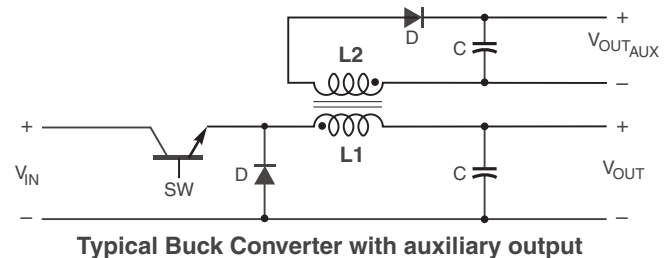
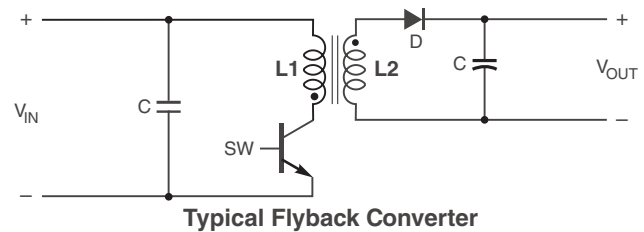



# MSD1514 Coupled Inductors

Part number <sup>1</sup>	Inductance <sup>2</sup> ( $\mu$ H)	DCR (Ohms) <sup>3</sup>		SRF typ <sup>4</sup> (MHz)	Coupling coefficient typ	Leakage inductance typ ( $\mu$ H)	Isat (A) <sup>5</sup>			Irms (A)	
		typ	max				10% drop	20% drop	30% drop	both windings <sup>6</sup>	one winding <sup>7</sup>
MSD1514-252ME_	2.5 $\pm$ 20%	0.010	0.012	34.0	0.97	0.20	25.0	28.0	30.5	5.1	7.8
MSD1514-472ME_	4.7 $\pm$ 20%	0.012	0.014	25.0	0.98	0.20	19.5	21.8	23.7	4.5	7.6
MSD1514-103ME_	10 $\pm$ 20%	0.015	0.018	16.5	0.99	0.40	13.4	15.0	16.2	4.0	6.8
MSD1514-123ME_	12 $\pm$ 20%	0.018	0.022	14.5	0.99	0.40	12.2	13.7	14.8	3.7	6.6
MSD1514-153ME_	15 $\pm$ 20%	0.024	0.028	11.0	>0.99	0.42	10.9	12.2	13.3	3.4	5.8
MSD1514-223ME_	22 $\pm$ 20%	0.031	0.036	10.0	>0.99	0.45	9.00	10.1	11.0	3.0	5.1
MSD1514-273ME_	27 $\pm$ 20%	0.034	0.039	8.50	>0.99	0.45	8.14	9.13	9.90	2.95	4.7
MSD1514-333ME_	33 $\pm$ 20%	0.045	0.052	7.20	>0.99	0.45	7.40	8.20	9.00	2.55	3.9
MSD1514-473ME_	47 $\pm$ 20%	0.065	0.075	5.60	>0.99	0.55	6.20	6.90	7.50	2.20	3.45
MSD1514-683ME_	68 $\pm$ 20%	0.078	0.090	5.20	>0.99	0.55	5.10	5.70	6.20	2.00	3.20
MSD1514-104KE_	100 $\pm$ 10%	0.115	0.126	3.80	>0.99	0.55	4.20	4.75	5.15	1.65	2.50
MSD1514-224KE_	220 $\pm$ 10%	0.261	0.287	2.30	>0.99	0.70	2.85	3.20	3.50	1.10	1.70
MSD1514-334KE_	330 $\pm$ 10%	0.334	0.367	2.10	>0.99	0.80	2.33	2.61	2.83	0.98	1.55
MSD1514-474KE_	470 $\pm$ 10%	0.500	0.550	1.65	>0.99	1.2	1.95	2.20	2.40	0.77	1.30
MSD1514-105KE_	1000 $\pm$ 10%	1.12	1.25	1.10	>0.99	2.0	1.34	1.50	1.63	0.55	0.77

1. When ordering, please specify **termination** and **packaging** codes:

### MSD1514-105KED

**Termination:** E = RoHS compliant matte tin over nickel over phos bronze.  
Special order: Q = RoHS tin-silver-copper (95.5/4/0.5)  
or P = non-RoHS tin-lead (63/37).

**Packaging:** D = 13" machine-ready reel. EIA-481 embossed plastic tape (175 parts per full reel).

B = Less than full reel. In tape, but not machine ready.  
To have a leader and trailer added (\$25 charge),  
use code letter D instead.

- Inductance shown for each winding, measured at 100 kHz, 0.1 Vrms, 0 Adc on an Agilent/HP 4284A LCR meter or equivalent. When leads are connected in parallel, inductance is the same value. When leads are connected in series, inductance is four times the value.
- DCR is for each winding. When leads are connected in parallel, DCR is half the value. When leads are connected in series, DCR is twice the value.
- SRF measured using an Agilent/HP 4191A or equivalent. When leads are connected in parallel, SRF is the same value.
- DC current at which the inductance drops the specified amount from its value without current. It is the sum of the current flowing in both windings.
- Equal current when applied to each winding simultaneously that causes a 40°C temperature rise from 25°C ambient.  
[Click for temperature derating information.](#)
- Maximum current when applied to one winding that causes a 40°C temperature rise from 25°C ambient. This information is for reference only and does not represent absolute maximum ratings.  
[Click for temperature derating information.](#)
- Electrical specifications at 25°C.  
Refer to Doc 639 "Selecting Coupled Inductors for SEPIC Applications."  
Refer to Doc 362 "Soldering Surface Mount Components" before soldering.

### Coupled Inductor Core and Winding Loss Calculator

This web-based utility allows you to enter frequency, peak-to-peak (ripple) current, and Irms current to predict temperature rise and overall losses, including core loss. [Go to online calculator.](#)



# MSD1514 Coupled Inductors

## Typical L vs Current

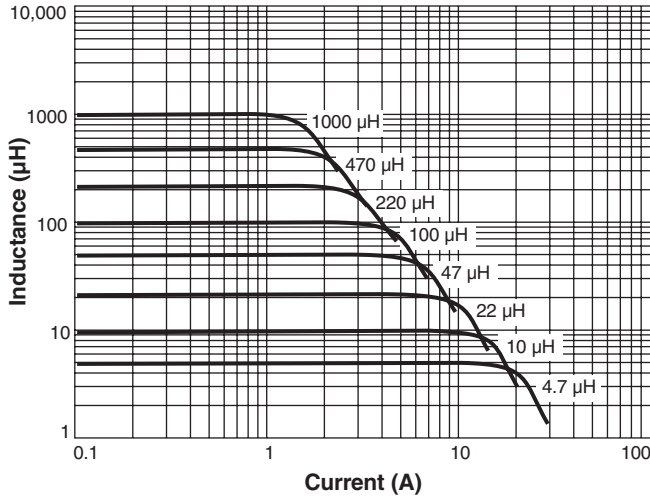

## Typical L vs Frequency

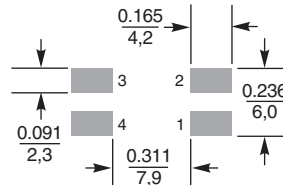
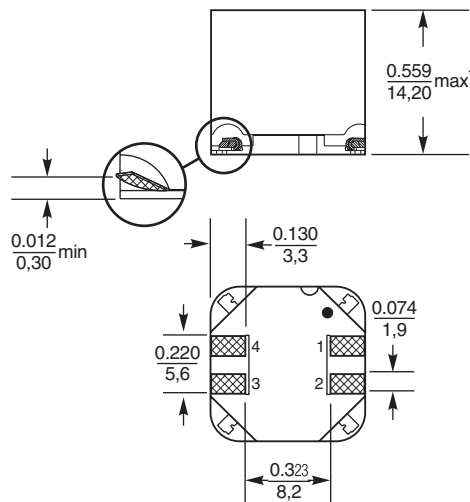
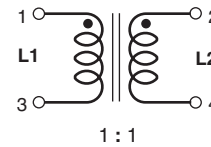
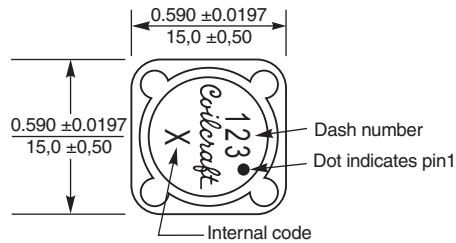
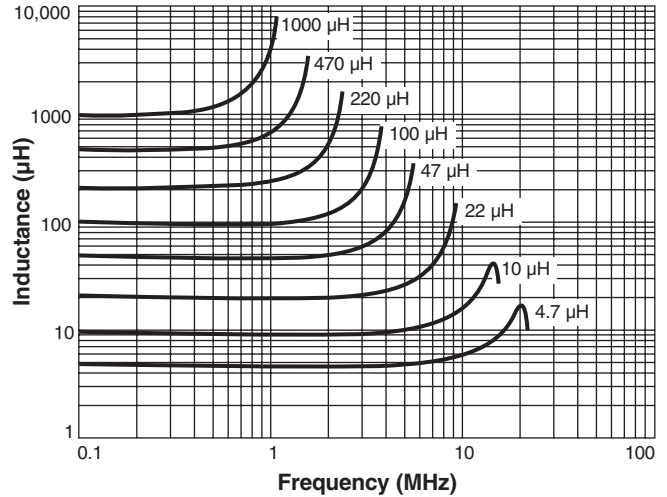

### Recommended Land Pattern

\* For optional tin-lead and tin-silver-copper terminations, dimensions are for the mounted part. Dimensions before mounting can be an additional 0.012 inch (0,3 mm).

Dimensions are in  $\frac{\text{inches}}{\text{mm}}$



**US** +1-847-639-6400 sales@coilcraft.com  
**UK** +44-1236-730595 sales@coilcraft-europe.com  
**Taiwan** +886-2-2264 3646 sales@coilcraft.com.tw  
**China** +86-21-6218 8074 sales@coilcraft.com.cn  
**Singapore** + 65-6484 8412 sales@coilcraft.com.sg

Document 1308-3 Revised 05/06/16  
 © Coilcraft Inc. 2018  
 This product may not be used in medical or high risk applications without prior Coilcraft approval. Specification subject to change without notice. Please check web site for latest information.



Компания «ЭлектроПласт» предлагает заключение долгосрочных отношений при поставках импортных электронных компонентов на взаимовыгодных условиях!

Наши преимущества:

- Оперативные поставки широкого спектра электронных компонентов отечественного и импортного производства напрямую от производителей и с крупнейших мировых складов;
- Поставка более 17-ти миллионов наименований электронных компонентов;
- Поставка сложных, дефицитных, либо снятых с производства позиций;
- Оперативные сроки поставки под заказ (от 5 рабочих дней);
- Экспресс доставка в любую точку России;
- Техническая поддержка проекта, помощь в подборе аналогов, поставка прототипов;
- Система менеджмента качества сертифицирована по Международному стандарту ISO 9001;
- Лицензия ФСБ на осуществление работ с использованием сведений, составляющих государственную тайну;
- Поставка специализированных компонентов (Xilinx, Altera, Analog Devices, Intersil, Interpoint, Microsemi, Aeroflex, Peregrine, Syfer, Eurofarad, Texas Instrument, Miteq, Cobham, E2V, MA-COM, Hittite, Mini-Circuits, General Dynamics и др.);

Помимо этого, одним из направлений компании «ЭлектроПласт» является направление «Источники питания». Мы предлагаем Вам помощь Конструкторского отдела:

- Подбор оптимального решения, техническое обоснование при выборе компонента;
- Подбор аналогов;
- Консультации по применению компонента;
- Поставка образцов и прототипов;
- Техническая поддержка проекта;
- Защита от снятия компонента с производства.



#### Как с нами связаться

**Телефон:** 8 (812) 309 58 32 (многоканальный)

**Факс:** 8 (812) 320-02-42

**Электронная почта:** [org@eplast1.ru](mailto:org@eplast1.ru)

**Адрес:** 198099, г. Санкт-Петербург, ул. Калинина, дом 2, корпус 4, литера А.