

X95820

Dual Digital Controlled Potentiometers (XDCP™) Low Noise/Low Power/I²C Bus/256 Taps

FN8212
Rev 2.00
July 18, 2006

The X95820 integrates two digitally controlled potentiometers (XDCP) on a monolithic CMOS integrated circuit.

The digitally controlled potentiometers are implemented with a combination of resistor elements and CMOS switches. The position of the wipers are controlled by the user through the I²C bus interface. Each potentiometer has an associated volatile Wiper Register (WR) and a non-volatile Initial Value Register (IVR), that can be directly written to and read by the user. The contents of the WR controls the position of the wiper. At power up the device recalls the contents of the two DCP's IVR to the corresponding WRs.

The DCPs can be used as three-terminal potentiometers or as two-terminal variable resistors in a wide variety of applications including control, parameter adjustments, and signal processing.

Ordering Information

| PART NUMBER | PART MARKING | RESISTANCE OPTION | PACKAGE |
|-----------------------------|--------------|-------------------|--------------------------|
| X95820WV14I-2.7* | X95820WV G | 10kΩ | 14 Ld TSSOP |
| X95820WV14IZ-2.7* (Note) | X95820WV Z G | 10kΩ | 14 Ld TSSOP (Pb-free) |
| X95820UV14I-2.7* | X95820UV G | 50kΩ | 14 Ld TSSOP |
| X95820UV14IZ-2.7* (Note) | X95820UV Z G | 50kΩ | 14 Ld TSSOP (Pb-free) |

*Add "T1" suffix for tape and reel.

NOTE: Intersil Pb-free plus anneal products employ special Pb-free material sets; molding compounds/die attach materials and 100% matte tin plate termination finish, which are RoHS compliant and compatible with both SnPb and Pb-free soldering operations. Intersil Pb-free products are MSL classified at Pb-free peak reflow temperatures that meet or exceed the Pb-free requirements of IPC/JEDEC J STD-020.

Features

- Two potentiometers in one package
- 256 resistor taps-0.4% resolution
- I²C serial interface
 - Three address pins, up to eight devices/bus
- Wiper resistance: 70Ω typical @ 3.3V
- Non-volatile storage of wiper position
- Standby current < 5μA max
- Power supply: 2.7V to 5.5V
- 50kΩ, 10kΩ total resistance
- High reliability
 - Endurance: 150,000 data changes per bit per register
 - Register data retention: 50 years @ T ≤ 75°C
- 14 Ld TSSOP
- Pb-free plus anneal available (RoHS compliant)

Pinouts

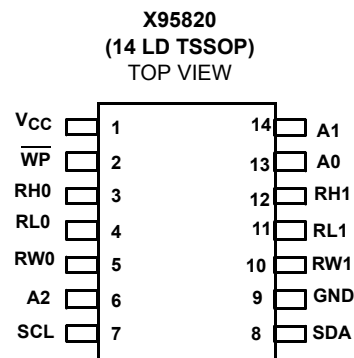

Block Diagram



PiN Descriptions

| PIN | SYMBOL | DESCRIPTION |
|-----|-----------------|--|
| 1 | V _{CC} | Power supply pin |
| 2 | \overline{WP} | Hardware write protection pin. Active low. Prevents any "Write" operation of the I ² C interface. |
| 3 | RH0 | "High" terminal of DCP0 |
| 4 | RL0 | "Low" terminal of DCP0 |
| 5 | RW0 | "Wiper" terminal of DCP0 |
| 6 | A2 | Device address for the I ² C interface |
| 7 | SCL | I ² C interface clock |
| 8 | SDA | Serial data I/O for the I ² C interface |
| 9 | GND | Ground |
| 10 | RW1 | "Wiper" terminal of DCP1 |
| 11 | RL1 | "Low" terminal of DCP1 |
| 12 | RH1 | "High" terminal of DCP1 |
| 13 | A0 | Device address for the I ² C interface |
| 14 | A1 | Device address for the I ² C interface |

Absolute Maximum Ratings

| | |
|--|-----------------------|
| Storage Temperature | -65°C to +150°C |
| Voltage at Any Digital Interface Pin with Respect to GND | -0.3V to $V_{CC}+0.3$ |
| V_{CC} | -0.3V to +6V |
| Voltage at Any DCP Pin with Respect to GND | -0.3V to V_{CC} |
| Lead Temperature (soldering, 10s) | 300°C |
| I_W (10s) | ±6mA |

Recommended Operating Conditions

| | |
|--------------------------------|---------------|
| Temperature Range (Industrial) | -40°C to 85°C |
| V_{CC} | 2.7V to 5.5V |
| Power Rating of Each DCP | .5mW |
| Wiper Current of Each DCP | ±3.0mA |

CAUTION: Stresses above those listed under "Absolute Maximum Ratings" may cause permanent damage to the device. This is a stress rating only; functional operation of the device (at these or any other conditions above those listed in the operational sections of this specification) is not implied. Exposure to absolute maximum rating conditions for extended periods may affect device reliability.

Analog Specifications Over recommended operating conditions unless otherwise stated.

| SYMBOL | PARAMETER | TEST CONDITIONS | MIN | TYP (Note 1) | MAX | UNIT |
|--|-------------------------------------|---|------|--------------|-----|--------------|
| R_{TOTAL} | R_H to R_L Resistance | W, U versions respectively | | 10, 50 | | k Ω |
| | R_H to R_L Resistance Tolerance | | -20 | | +20 | % |
| R_W | Wiper Resistance | $V_{CC} = 3.3V @ 25^\circ C$ Wiper current = V_{CC}/R_{TOTAL} | | 70 | 200 | Ω |
| $C_H/C_L/C_W$ | Potentiometer Capacitance (Note 15) | | | 10/10/25 | | pF |
| I_{LkgDCP} | Leakage on DCP Pins (Note 15) | Voltage at pin from GND to V_{CC} | | 0.1 | 1 | μA |
| VOLTAGE DIVIDER MODE (0V @ RL_i ; V_{CC} @ RH_i ; measured at RW_i , unloaded; $i = 0$ or 1) | | | | | | |
| INL (Note 6) | Integral Non-linearity | | -1 | | 1 | LSB (Note 2) |
| DNL (Note 5) | Differential Non-linearity | Monotonic over all tap positions | -0.5 | | 0.5 | LSB (Note 2) |
| ZSerror (Note 3) | Zero-scale Error | U option | 0 | 1 | 7 | LSB (Note 2) |
| | | W option | 0 | 0.5 | 2 | |
| FSerror (Note 4) | Full-scale Error | U option | -7 | -1 | 0 | LSB (Note 2) |
| | | W option | -2 | -1 | 0 | |
| V_{MATCH} (Note 7) | DCP to DCP Matching | Any two DCPs at same tap position, same voltage at all RH terminals, and same voltage at all RL terminals | -2 | | 2 | LSB (Note 2) |
| TC_V (Note 8) | Ratiometric Temperature Coefficient | DCP Register set to 80 hex | | ±4 | | ppm/°C |
| RESISTOR MODE (Measurements between RW_i and RL_i with RH_i not connected, or between RW_i and RH_i with RL_i not connected. $i = 0$ or 1) | | | | | | |
| RINL (Note 12) | Integral Non-linearity | DCP register set between 20 hex and FF hex. Monotonic over all tap positions | -1 | | 1 | MI (Note 9) |
| RDNL (Note 11) | Differential Non-linearity | | -0.5 | | 0.5 | MI (Note 9) |
| Roffset (Note 10) | Offset | DCP Register set to 00 hex, U option | 0 | 1 | 7 | MI (Note 9) |
| | | DCP Register set to 00 hex, W option | 0 | 0.5 | 2 | MI (Note 9) |
| R_{MATCH} (Note 13) | DCP to DCP Matching | Any two DCPs at the same tap position with the same terminal voltages. | -2 | | 2 | MI (Note 9) |
| TC_R (Note 14) | Resistance Temperature Coefficient | DCP register set between 20 hex and FF hex | | ±45 | | ppm/°C |

Operating Specifications Over the recommended operating conditions unless otherwise specified.

| SYMBOL | PARAMETER | TEST CONDITIONS | MIN | TYP (Note 1) | MAX | UNITS |
|-------------------------------|---|---|--------------------------|-----------------|----------------------|--------|
| I _{CC1} | V _{CC} Supply Current (Volatile write/read) | f _{SCL} = 400kHz; SDA = Open; (for I ² C, Active, Read and Volatile Write States only) | | | 1 | mA |
| I _{CC2} | V _{CC} Supply Current (nonvolatile write) | f _{SCL} = 400kHz; SDA = Open; (for I ² C, Active, Nonvolatile Write State only) | | | 3 | mA |
| I _{SB} | V _{CC} Current (standby) | V _{CC} = +5.5V, I ² C Interface in Standby State | | | 5 | μA |
| | | V _{CC} = +3.6V, I ² C Interface in Standby State | | | 2 | μA |
| I _{LkgDig} | Leakage Current, at Pins A0, A1, A2, SDA, SCL, and \overline{WP} Pins | Voltage at pin from GND to V _{CC} | -10 | | 10 | μA |
| t _{DCP} (Note 15) | DCP Wiper Response Time | SCL falling edge of last bit of DCP Data Byte to wiper change | | | 1 | μs |
| V _{por} | Power-on Recall Voltage | Minimum V _{CC} at which memory recall occurs | 1.8 | | 2.6 | V |
| V _{ccRamp} | V _{CC} Ramp Rate | | 0.2 | | | V/ms |
| t _D (Note 15) | Power-up Delay | V _{CC} above V _{por} , to DCP Initial Value Register recall completed, and I ² C Interface in standby state | | | 3 | ms |
| EEPROM SPECS | | | | | | |
| | EEPROM Endurance | | 150,000 | | | Cycles |
| | EEPROM Retention | Temperature ≤ 75°C | 50 | | | Years |
| SERIAL INTERFACE SPECS | | | | | | |
| V _{IL} | \overline{WP} , A2, A1, A0, SDA, and SCL input buffer LOW voltage | | -0.3 | | 0.3*V _{cc} | V |
| V _{IH} | \overline{WP} , A2, A1, A0, SDA, and SCL Input Buffer HIGH Voltage | | 0.7*V _{cc} | | V _{cc} +0.3 | V |
| Hysteresis (Note 15) | SDA and SCL input buffer hysteresis | | 0.05* V _{cc} | | | V |
| V _{OL} (Note 15) | SDA Output Buffer LOW Voltage, Sinking 4mA | | 0 | | 0.4 | V |
| C _{pin} (Note 15) | \overline{WP} , A2, A1, A0, SDA, and SCL Pin Capacitance | | | | 10 | pF |
| f _{SCL} | SCL Frequency | | | | 400 | kHz |
| t _{IN} (Note 15) | Pulse Width Suppression Time at SDA and SCL Inputs | Any pulse narrower than the max spec is suppressed. | | | 50 | ns |
| t _{AA} (Note 15) | SCL Falling Edge to SDA Output Data Valid | SCL falling edge crossing 30% of V _{CC} , until SDA exits the 30% to 70% of V _{CC} window. | | | 900 | ns |
| t _{BUF} (Note 15) | Time the Bus Must be Free Before the Start of a New Transmission | SDA crossing 70% of V _{CC} during a STOP condition, to SDA crossing 70% of V _{CC} during the following START condition. | 1300 | | | ns |
| t _{LOW} | Clock LOW Time | Measured at the 30% of V _{CC} crossing. | 1300 | | | ns |
| t _{HIGH} | Clock HIGH Time | Measured at the 70% of V _{CC} crossing. | 600 | | | ns |
| t _{SU:STA} | START Condition Setup Time | SCL rising edge to SDA falling edge. Both crossing 70% of V _{CC} . | 600 | | | ns |
| t _{HD:STA} | START Condition Hold Time | From SDA falling edge crossing 30% of V _{CC} to SCL falling edge crossing 70% of V _{CC} . | 600 | | | ns |

Operating Specifications Over the recommended operating conditions unless otherwise specified. (Continued)

| SYMBOL | PARAMETER | TEST CONDITIONS | MIN | TYP (Note 1) | MAX | UNITS |
|----------------------------|--|---|---------------------|-----------------|-----|------------|
| $t_{SU:DAT}$ | Input Data Setup Time | From SDA exiting the 30% to 70% of V_{CC} window, to SCL rising edge crossing 30% of V_{CC} | 100 | | | ns |
| $t_{HD:DAT}$ | Input Data Hold Time | From SCL rising edge crossing 70% of V_{CC} to SDA entering the 30% to 70% of V_{CC} window. | 0 | | | ns |
| $t_{SU:STO}$ | STOP Condition Setup Time | From SCL rising edge crossing 70% of V_{CC} , to SDA rising edge crossing 30% of V_{CC} . | 600 | | | ns |
| $t_{HD:STO}$ | STOP Condition Setup Time | From SDA rising edge to SCL falling edge. Both crossing 70% of V_{CC} . | 600 | | | ns |
| t_{DH} (Note 15) | Output Data Hold Time | From SCL falling edge crossing 30% of V_{CC} , until SDA enters the 30% to 70% of V_{CC} window. | 0 | | | ns |
| t_R (Note 15) | SDA and SCL Rise Time | From 30% to 70% of V_{CC} | 20 + 0.1 * C_b | | 250 | ns |
| t_F (Note 15) | SDA and SCL Fall Time | From 70% to 30% of V_{CC} | 20 + 0.1 * C_b | | 250 | ns |
| C_b (Note 15) | Capacitive Loading of SDA or SCL | Total on-chip and off-chip | 10 | | 400 | pF |
| R_{pu} (Note 15) | SDA and SCL Bus Pull-up resistor Off-chip | Maximum is determined by t_R and t_F . For $C_b = 400\text{pF}$, max is about 2~2.5k Ω . For $C_b = 40\text{pF}$, max is about 15~20k Ω . | 1 | | | k Ω |
| t_{WP} (Notes 15, 16) | Non-volatile Write Cycle Time | | | 12 | 20 | ms |
| $t_{SU:WPA}$ | A2, A1, A0, and \overline{WP} Setup Time | Before START condition | 600 | | | ns |
| $t_{HD:WPA}$ | A2, A1, A0, and \overline{WP} Hold Time | After STOP condition | 600 | | | ns |

SDA vs. SCL Timing

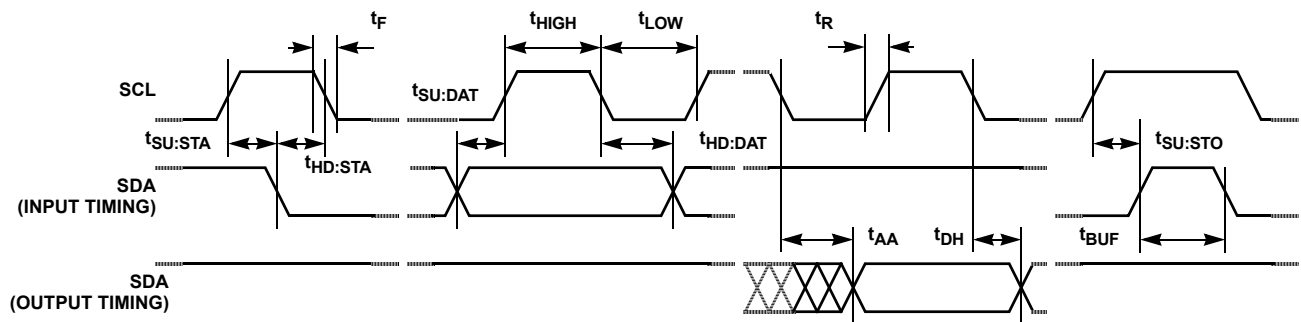

\overline{WP} , A0, A1, and A2 Pin Timing

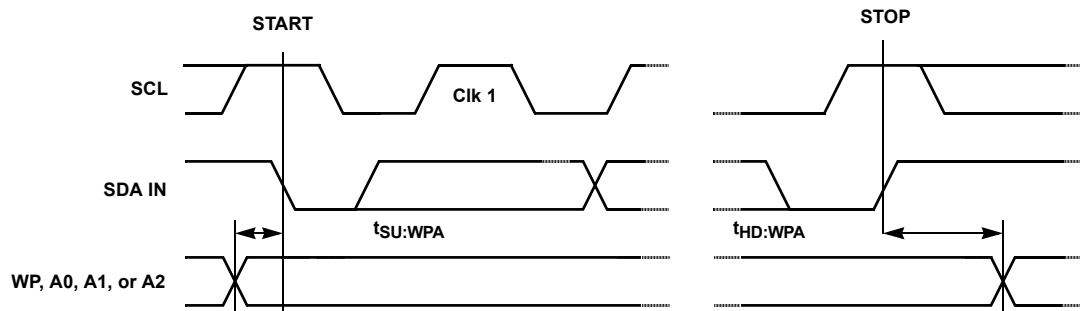

NOTES:

1. Typical values are for $T_A = 25^\circ\text{C}$ and 3.3V supply voltage.
2. LSB: $[V(RW)_{255} - V(RW)_0] / 255$. $V(RW)_{255}$ and $V(RW)_0$ are $V(RW)$ for the DCP register set to FF hex and 00 hex respectively. LSB is the incremental voltage when changing from one tap to an adjacent tap.
3. ZS error = $V(RW)_0 / \text{LSB}$.
4. FS error = $[V(RW)_{255} - V_{CC}] / \text{LSB}$.
5. DNL = $[V(RW)_i - V(RW)_{i-1}] / \text{LSB} - 1$, for $i = 1$ to 255. i is the DCP register setting.
6. INL = $[V(RW)_i - (i \cdot \text{LSB} - V(RW)_0)] / \text{LSB}$ for $i = 1$ to 255.
7. $V_{\text{MATCH}} = [V(RW_x)_i - V(RW_y)_i] / \text{LSB}$, for $i = 0$ to 255, $x = 0$ to 1 and $y = 0$ to 1.
8. $TC_V = \frac{\text{Max}(V(RW)_i) - \text{Min}(V(RW)_i)}{[\text{Max}(V(RW)_i) + \text{Min}(V(RW)_i)]/2} \times \frac{10^6}{125^\circ\text{C}}$
for $i = 16$ to 240 decimal, $T = -40^\circ\text{C}$ to 85°C . $\text{Max}()$ is the maximum value of the wiper voltage and $\text{Min}()$ is the minimum value of the wiper voltage over the temperature range.
9. $MI = |R_{255} - R_0| / 255$. R_{255} and R_0 are the measured resistances for the DCP register set to FF hex and 00 hex respectively.
10. $R_{\text{offset}} = R_0 / MI$, when measuring between RW and RL.
 $R_{\text{offset}} = R_{255} / MI$, when measuring between RW and RH.
11. $RDNL = (R_i - R_{i-1}) / MI$, for $i = 32$ to 255.
12. $RINL = [R_i - (MI \cdot i) - R_0] / MI$, for $i = 32$ to 255.
13. $R_{\text{MATCH}} = (R_{i,x} - R_{i,y}) / MI$, for $i = 0$ to 255, $x = 0$ to 1 and $y = 0$ to 1.
14. $TC_R = \frac{[\text{Max}(R_i) - \text{Min}(R_i)]}{[\text{Max}(R_i) + \text{Min}(R_i)]/2} \times \frac{10^6}{125^\circ\text{C}}$
for $i = 32$ to 255, $T = -40^\circ\text{C}$ to 85°C . $\text{Max}()$ is the maximum value of the resistance and $\text{Min}()$ is the minimum value of the resistance over the temperature range.
15. This parameter is not 100% tested.
16. t_{WC} is the minimum cycle time to be allowed for any non-volatile Write by the user, unless Acknowledge Polling is used. It is the time from a valid STOP condition at the end of a Write sequence of a I²C serial interface Write operation, to the end of the self-timed internal non-volatile write cycle.

Typical Performance Curves

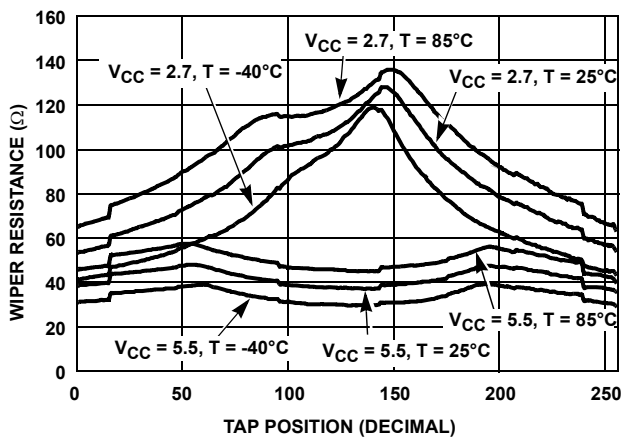

FIGURE 1. WIPER RESISTANCE vs TAP POSITION
[$I(RW) = V_{CC}/R_{\text{TOTAL}}$] FOR 50kΩ (U)

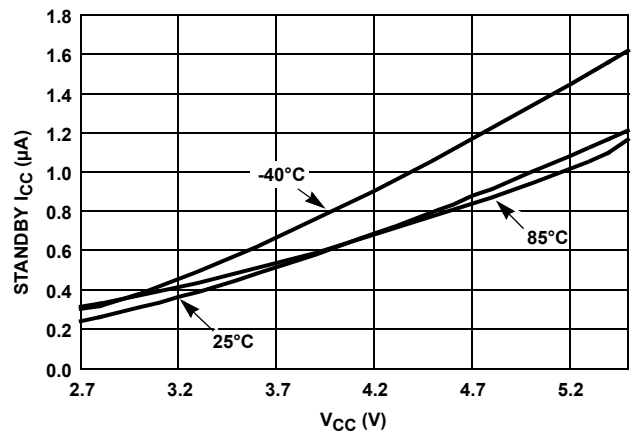

FIGURE 2. STANDBY I_{CC} vs V_{CC}

Typical Performance Curves (Continued)

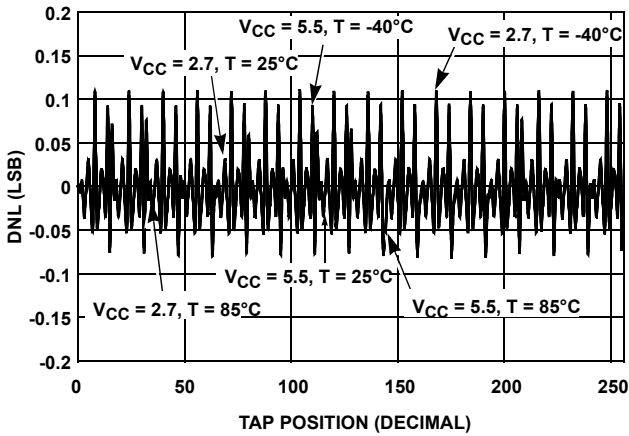

FIGURE 3. DNL vs TAP POSITION IN VOLTAGE DIVIDER MODE FOR 10kΩ (W)

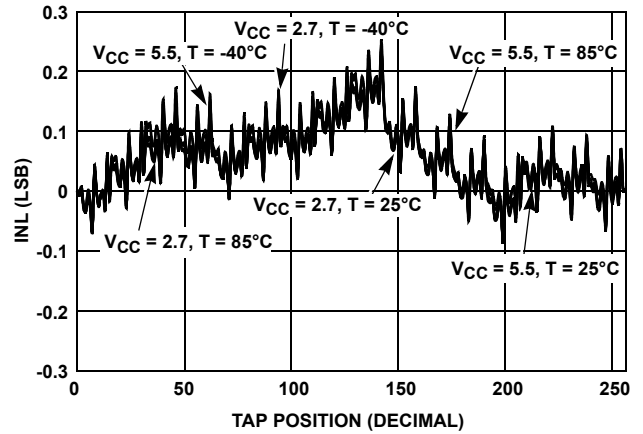

FIGURE 4. INL vs TAP POSITION IN VOLTAGE DIVIDER MODE FOR 10kΩ (W)



FIGURE 5. ZSerror vs TEMPERATURE

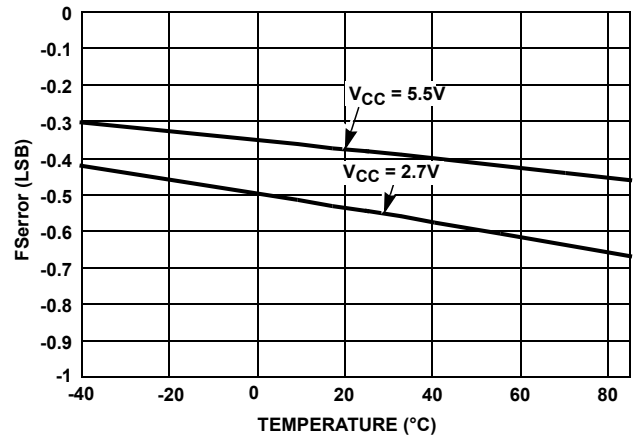

FIGURE 6. FSerror vs TEMPERATURE

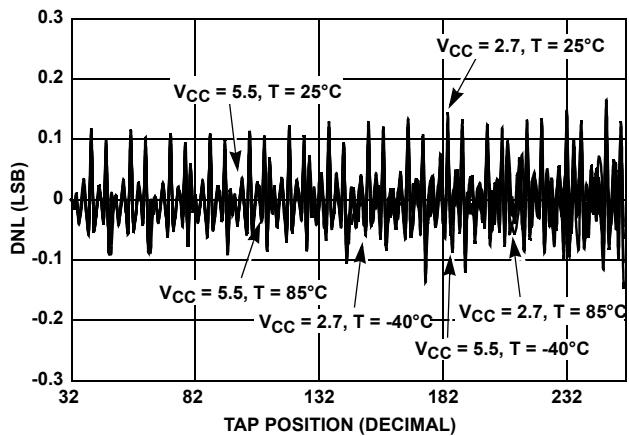

FIGURE 7. DNL vs TAP POSITION IN Rheostat MODE FOR 50kΩ (U)

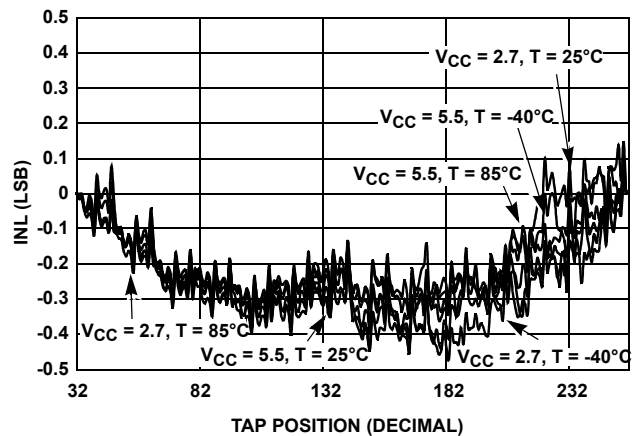

FIGURE 8. INL vs TAP POSITION IN Rheostat MODE FOR 50kΩ (U)

Typical Performance Curves (Continued)

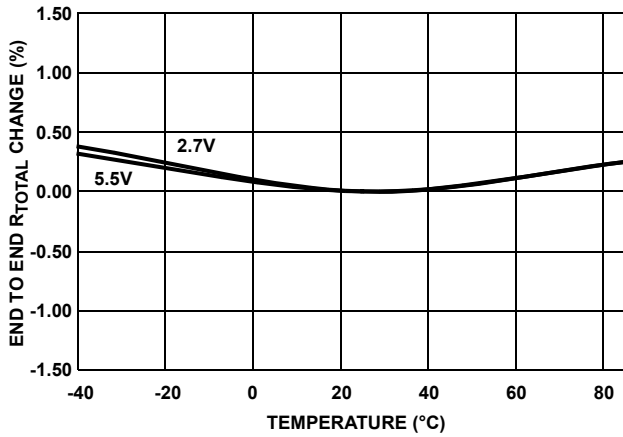

FIGURE 9. END TO END R_{TOTAL} % CHANGE vs TEMPERATURE

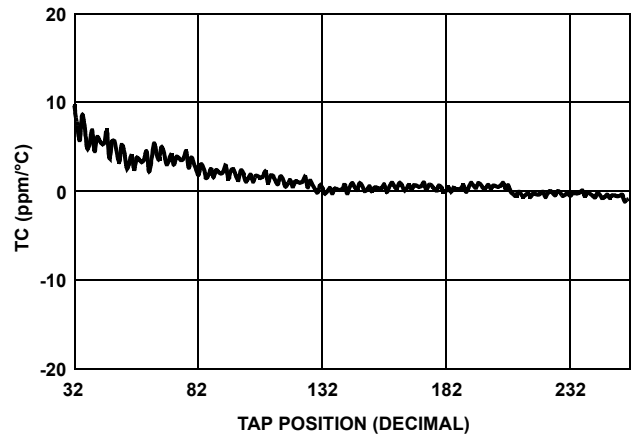

FIGURE 10. TC FOR VOLTAGE DIVIDER MODE IN ppm

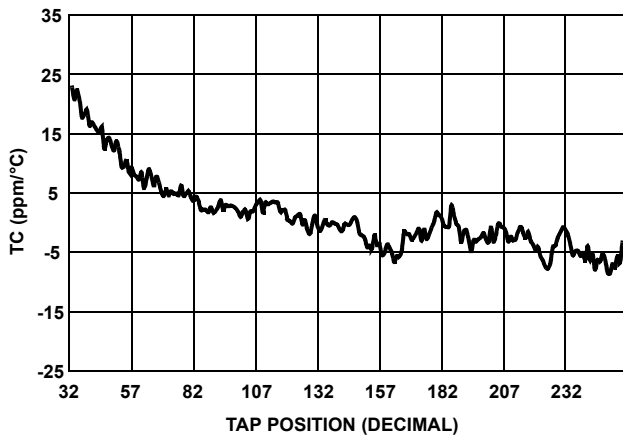

FIGURE 11. TC FOR Rheostat MODE IN ppm

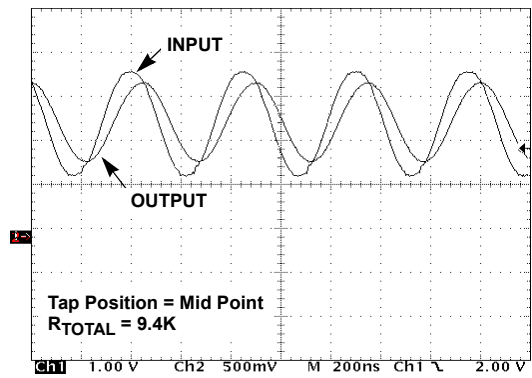

FIGURE 12. FREQUENCY RESPONSE (2.2MHz)

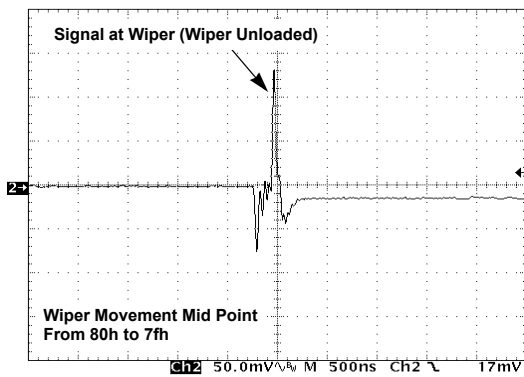

FIGURE 13. MIDSCALE GLITCH, CODE 80h TO 7fh (WIPER 0)



FIGURE 14. LARGE SIGNAL SETTLING TIME

Principles of Operation

The X95820 is an integrated circuit incorporating two DCPs with their associated registers, non-volatile memory, and a I²C serial interface providing direct communication between a host and the potentiometers and memory.

DCP Description

Each DCP is implemented with a combination of resistor elements and CMOS switches. The physical ends of each DCP are equivalent to the fixed terminals of a mechanical potentiometer (RH and RL pins). The RW pin of each DCP is connected to intermediate nodes, and is equivalent to the wiper terminal of a mechanical potentiometer. The position of the wiper terminal within the DCP is controlled by an 8-bit volatile Wiper Register (WR). Each DCP has its own WR. When the WR of a DCP contains all zeroes (WR<7:0>: 00h), its wiper terminal (RW) is closest to its "Low" terminal (RL). When the WR of a DCP contains all ones (WR<7:0>: FFh), its wiper terminal (RW) is closest to its "High" terminal (RH). As the value of the WR increases from all zeroes (00h) to all ones (255 decimal), the wiper moves monotonically from the position closest to RL to the closest to RH. At the same time, the resistance between RW and RL increases monotonically, while the resistance between RH and RW decreases monotonically.

While the X95820 is being powered up, all two WRs are reset to 80h (128 decimal), which locates RW roughly at the center between RL and RH. Soon after the power supply voltage becomes large enough for reliable non-volatile memory reading, the X95820 reads the value stored on two different non-volatile Initial Value Registers (IVRs) and loads them into their corresponding WRs.

The WRs and IVRs can be read or written directly using the I²C serial interface as described in the following sections.

Memory Description

The X95820 contains eight non-volatile bytes. They are accessed by I²C interface operations with Address Bytes 0 through 7 decimal. The first two non-volatile bytes at addresses 0 and 1 contain the initial value loaded at power-up into the volatile Wiper Registers (WRs) of DCP0 and DCP1 respectively. Bytes at addresses 2, 3, 4, 5, and 6 are available to the user as general purpose registers. The byte at address 7 is reserved; the user should not write to it, and its value should be ignored if read.

The volatile WR, and the non-volatile Initial Value Register (IVR) of a DCP are accessed with the same Address Byte.

A volatile byte at address 8 decimal, controls what byte is read or written when accessing DCP registers: the WR, the IVR, or both.

When the byte at address 8 is all zeroes, which is the default at power up:

- A read operation to addresses 0 or 1 outputs the value of the non-volatile IVRs.
- A write operation to addresses 0 or 1 writes the same value to the WR and IVR of the corresponding DCP.

When the byte at address 8 is 80h (128 decimal):

- A read operation to addresses 0 or 1 outputs the value of the volatile WR.
- A write operation to addresses 0 or 1 only writes to the corresponding volatile WR.

It is not possible to write to an IVR without writing the same value to its corresponding WR.

00h and 80h are the only values that should be written to address 8. All other values are reserved and must not be written to address 8.

To access the general purpose bytes at addresses 2, 3, 4, 5, or 6, the value at address 8 must be all zeros.

The X95820 is pre-programmed with 80h in the two IVRs.

TABLE 1. MEMORY MAP

| ADDRESS | NON-VOLATILE | VOLATILE |
|---------|-----------------|----------------|
| 8 | - | Access Control |
| 7 | Reserved | |
| 6 | General Purpose | Not Available |
| 5 | | |
| 4 | | |
| 3 | | |
| 2 | | |
| 1 | IVR1 | WR1 |
| 0 | IVR0 | WR0 |

WR: Wiper Register, IVR: Initial value Register.

I²C Serial Interface

The X95820 supports a bidirectional I²C bus oriented protocol. The protocol defines any device that sends data onto the bus as a transmitter and the receiving device as the receiver. The device controlling the transfer is a master and the device being controlled is the slave. The master always initiates data transfers and provides the clock for both transmit and receive operations. Therefore, the X95820 operates as a slave device in all applications.

All communication over the I²C interface is conducted by sending the MSB of each byte of data first.

Protocol Conventions

Data states on the SDA line can change only during SCL LOW periods. SDA state changes during SCL HIGH are reserved for indicating START and STOP conditions (See Figure 15). On power up of the X95820 the SDA pin is in the input mode.

All I²C interface operations must begin with a START condition, which is a HIGH to LOW transition of SDA while SCL is HIGH. The X95820 continuously monitors the SDA and SCL lines for the START condition and does not respond to any command until this condition is met (See Figure 15). A START condition is ignored during the power up sequence and during internal non-volatile write cycles.

All I²C interface operations must be terminated by a STOP condition, which is a LOW to HIGH transition of SDA while SCL is HIGH (See Figure 15). A STOP condition at the end of a read operation, or at the end of a write operation to volatile bytes only places the device in its standby mode. A STOP condition during a write operation to a non-volatile byte, initiates an internal non-volatile write cycle. The device enters its standby state when the internal non-volatile write cycle is completed.

An ACK, Acknowledge, is a software convention used to indicate a successful data transfer. The transmitting device, either master or slave, releases the SDA bus after transmitting eight bits. During the ninth clock cycle, the receiver pulls the

SDA line LOW to acknowledge the reception of the eight bits of data (See Figure 16).

The X95820 responds with an ACK after recognition of a START condition followed by a valid Identification Byte, and once again after successful receipt of an Address Byte. The X95820 also responds with an ACK after receiving a Data Byte of a write operation. The master must respond with an ACK after receiving a Data Byte of a read operation

A valid Identification Byte contains 1010 as the four MSBs, and the following three bits matching the logic values present at pins A2, A1, and A0. The LSB in the Read/Write bit. Its value is "1" for a Read operation, and "0" for a Write operation (See Table 2).

TABLE 2. IDENTIFICATION BYTE FORMAT

Logic values at pins A2, A1, and A0 respectively

| | | | | | | | |
|-------|---|---|---|----|----|----|-------|
| 1 | 0 | 1 | 0 | A2 | A1 | A0 | R/W |
| (MSB) | | | | | | | (LSB) |



FIGURE 15. VALID DATA CHANGES, START, AND STOP CONDITIONS

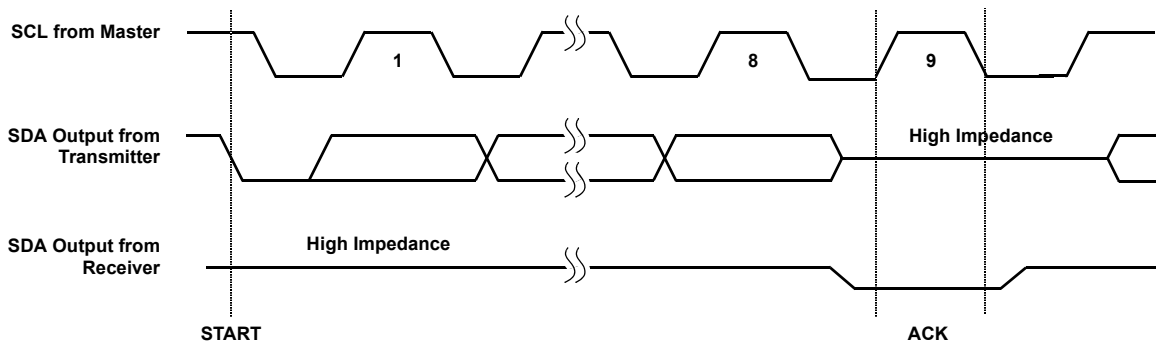

FIGURE 16. ACKNOWLEDGE RESPONSE FROM RECEIVER



FIGURE 17. BYTE WRITE SEQUENCE

Write Operation

A Write operation requires a START condition, followed by a valid Identification Byte, a valid Address Byte, a Data Byte, and a STOP condition. After each of the three bytes, the X95820 responds with an ACK. At this time, if the Data Byte is to be written only to volatile registers, then the device enters its standby state. If the Data Byte is to be written also to non-volatile memory, the X95820 begins its internal write cycle to non-volatile memory. During the internal non-volatile write cycle, the device ignores transitions at the SDA and SCL pins, and the SDA output is at a high impedance state. When the internal non-volatile write cycle is completed, the X95820 enters its standby state (See Figure 17).

The byte at address 00001000 bin (8 decimal) determines if the Data Byte is to be written to volatile and/or non-volatile memory. See "Memory Description" on page 9.

Data Protection

The \overline{WP} pin has to be at logic HIGH to perform any Write operation to the device. When the \overline{WP} is active (LOW) the device ignores Data Bytes of a Write Operation, does not respond to the Data Bytes with an ACK, and instead, goes to its standby state waiting for a new START condition.

A STOP condition also acts as a protection of non-volatile memory. A valid Identification Byte, Address Byte, and total number of SCL pulses act as a protection of both volatile and non-volatile registers. During a Write sequence, the Data Byte is loaded into an internal shift register as it is received. If the Address Byte is 0, 1, or 8 decimal, the Data Byte is transferred to the appropriate Wiper Register (WR) or to the Access

Control Register, at the falling edge of the SCL pulse that loads the last bit (LSB) of the Data Byte. If the Address Byte is between 0 and 6 (inclusive), and the Access Control Register is all zeros (default), then the STOP condition initiates the internal write cycle to non-volatile memory.

Read Operation

A Read operation consists of a three byte instruction followed by one or more Data Bytes (See Figure 18). The master initiates the operation issuing the following sequence: a START, the Identification byte with the R/\overline{W} bit set to "0", an Address Byte, a second START, and a second Identification byte with the R/\overline{W} bit set to "1". After each of the three bytes, the X95820 responds with an ACK. Then the X95820 transmits Data Bytes as long as the master responds with an ACK during the SCL cycle following the eighth bit of each byte. The master terminates the read operation (issuing a STOP condition) following the last bit of the last Data Byte (See Figure 18).

The Data Bytes are from the memory location indicated by an internal pointer. This pointer initial value is determined by the Address Byte in the Read operation instruction, and increments by one during transmission of each Data Byte. After reaching the memory location 01Fh (8 decimal) the pointer "rolls over" to 00h, and the device continues to output data for each ACK received.

The byte at address 00001000 bin (8 decimal) determines if the Data Bytes being read are from volatile or non-volatile memory. See "Memory Description" on page 9.

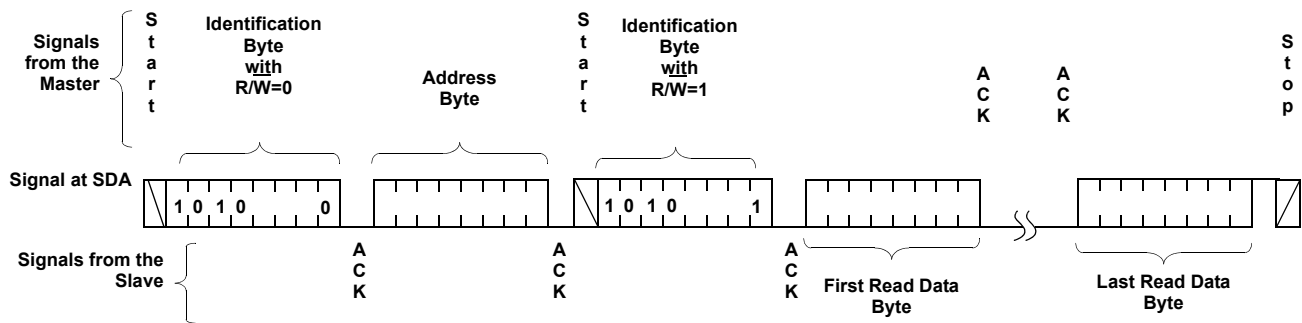

FIGURE 18. READ SEQUENCE

Thin Shrink Small Outline Plastic Packages (TSSOP)



M14.173
14 LEAD THIN SHRINK SMALL OUTLINE PLASTIC PACKAGE

| SYMBOL | INCHES | | MILLIMETERS | | NOTES |
|--------|-----------|--------|-------------|------|-------|
| | MIN | MAX | MIN | MAX | |
| A | - | 0.047 | - | 1.20 | - |
| A1 | 0.002 | 0.006 | 0.05 | 0.15 | - |
| A2 | 0.031 | 0.041 | 0.80 | 1.05 | - |
| b | 0.0075 | 0.0118 | 0.19 | 0.30 | 9 |
| c | 0.0035 | 0.0079 | 0.09 | 0.20 | - |
| D | 0.195 | 0.199 | 4.95 | 5.05 | 3 |
| E1 | 0.169 | 0.177 | 4.30 | 4.50 | 4 |
| e | 0.026 BSC | | 0.65 BSC | | - |
| E | 0.246 | 0.256 | 6.25 | 6.50 | - |
| L | 0.0177 | 0.0295 | 0.45 | 0.75 | 6 |
| N | 14 | | 14 | | 7 |
| α | 0° | 8° | 0° | 8° | - |

NOTES:

1. These package dimensions are within allowable dimensions of JEDEC MO-153-AC, Issue E.
2. Dimensioning and tolerancing per ANSI Y14.5M-1982.
3. Dimension "D" does not include mold flash, protrusions or gate burrs. Mold flash, protrusion and gate burrs shall not exceed 0.15mm (0.006 inch) per side.
4. Dimension "E1" does not include interlead flash or protrusions. Interlead flash and protrusions shall not exceed 0.15mm (0.006 inch) per side.
5. The chamfer on the body is optional. If it is not present, a visual index feature must be located within the crosshatched area.
6. "L" is the length of terminal for soldering to a substrate.
7. "N" is the number of terminal positions.
8. Terminal numbers are shown for reference only.
9. Dimension "b" does not include dambar protrusion. Allowable dambar protrusion shall be 0.08mm (0.003 inch) total in excess of "b" dimension at maximum material condition. Minimum space between protrusion and adjacent lead is 0.07mm (0.0027 inch).
10. Controlling dimension: MILLIMETER. Converted inch dimensions are not necessarily exact. (Angles in degrees)

Rev. 2 4/06

© Copyright Intersil Americas LLC 2005-2006. All Rights Reserved.
 All trademarks and registered trademarks are the property of their respective owners.

For additional products, see www.intersil.com/en/products.html

Intersil products are manufactured, assembled and tested utilizing ISO9001 quality systems as noted in the quality certifications found at www.intersil.com/en/support/qualandreliability.html

Intersil products are sold by description only. Intersil may modify the circuit design and/or specifications of products at any time without notice, provided that such modification does not, in Intersil's sole judgment, affect the form, fit or function of the product. Accordingly, the reader is cautioned to verify that datasheets are current before placing orders. Information furnished by Intersil is believed to be accurate and reliable. However, no responsibility is assumed by Intersil or its subsidiaries for its use; nor for any infringements of patents or other rights of third parties which may result from its use. No license is granted by implication or otherwise under any patent or patent rights of Intersil or its subsidiaries.

For information regarding Intersil Corporation and its products, see www.intersil.com



Компания «ЭлектроПласт» предлагает заключение долгосрочных отношений при поставках импортных электронных компонентов на взаимовыгодных условиях!

Наши преимущества:

- Оперативные поставки широкого спектра электронных компонентов отечественного и импортного производства напрямую от производителей и с крупнейших мировых складов;
- Поставка более 17-ти миллионов наименований электронных компонентов;
- Поставка сложных, дефицитных, либо снятых с производства позиций;
- Оперативные сроки поставки под заказ (от 5 рабочих дней);
- Экспресс доставка в любую точку России;
- Техническая поддержка проекта, помощь в подборе аналогов, поставка прототипов;
- Система менеджмента качества сертифицирована по Международному стандарту ISO 9001;
- Лицензия ФСБ на осуществление работ с использованием сведений, составляющих государственную тайну;
- Поставка специализированных компонентов (Xilinx, Altera, Analog Devices, Intersil, Interpoint, Microsemi, Aeroflex, Peregrine, Syfer, Eurofarad, Texas Instrument, Miteq, Cobham, E2V, MA-COM, Hittite, Mini-Circuits, General Dynamics и др.);

Помимо этого, одним из направлений компании «ЭлектроПласт» является направление «Источники питания». Мы предлагаем Вам помощь Конструкторского отдела:

- Подбор оптимального решения, техническое обоснование при выборе компонента;
- Подбор аналогов;
- Консультации по применению компонента;
- Поставка образцов и прототипов;
- Техническая поддержка проекта;
- Защита от снятия компонента с производства.



Как с нами связаться

Телефон: 8 (812) 309 58 32 (многоканальный)

Факс: 8 (812) 320-02-42

Электронная почта: org@eplast1.ru

Адрес: 198099, г. Санкт-Петербург, ул. Калинина, дом 2, корпус 4, литера А.