

V_{DSS}	30V
$R_{DS(on)}(Max.)$	240mΩ
I_D	±1.4A
P_D	0.8W

●Features

- 1) Nch MOSFET and schottky barrier diode are put in WEMT6 package.
- 2) High-speed switching and Low on-resistance.
- 3) Built-in Low V_F schottky barrier diode.

●Application

Switching

●Absolute maximum ratings ($T_a = 25^\circ C$, unless otherwise specified)

< MOSFET >

Parameter	Symbol	Value	Unit
Drain - Source voltage	V_{DSS}	30	V
Gate - Source voltage	V_{GSS}	±20	V
Continuous drain current	I_D	±1.4	A
Pulsed drain current	I_{DP}^{*1}	±2.8	A
Continuous source current (body diode)	I_S	0.5	A
Pulsed source current (body diode)	I_{SP}^{*1}	2.8	A
Power dissipation	P_D^{*2}	0.7	W/element
Junction temperature	T_j	150	°C

●Outline

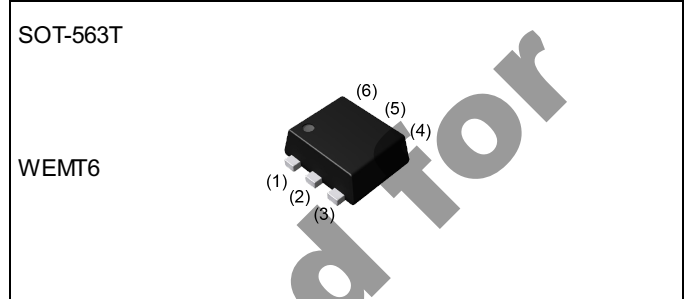

●Inner circuit

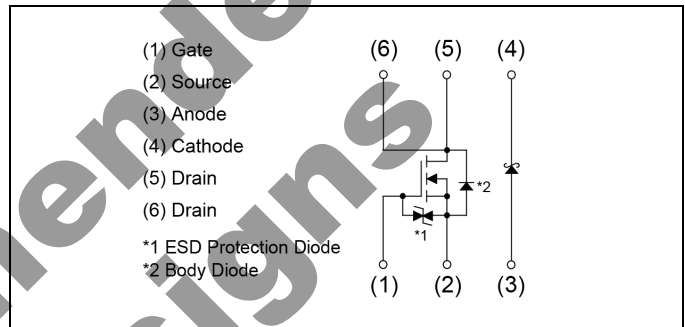

●Packaging specifications

Type	Packing	Embossed Tape
	Reel size (mm)	180
	Tape width (mm)	8
	Basic ordering unit (pcs)	8000
	Taping code	T2R
	Marking	U03

● **Absolute maximum ratings** ($T_a = 25^\circ\text{C}$)

< Diode >

Parameter	Symbol	Value	Unit
Repetitive peak reverse voltage	V_{RM}	25	V
Reverse voltage	V_R	20	V
Forward current	I_F	0.5	A
Forward current surge peak	I_{FSM}^{*3}	2.0	A
Power dissipation	P_D^{*2}	0.5	W/element
Junction temperature	T_j	150	$^\circ\text{C}$

< MOSFET + Diode >

Parameter	Symbol	Value	Unit
Power dissipation	P_D^{*2}	0.8	W/total
Operating junction and storage temperature range	T_{stg}	-55 to +150	$^\circ\text{C}$

● **Electrical characteristics** ($T_a = 25^\circ\text{C}$)

< MOSFET >

Parameter	Symbol	Conditions	Values			Unit
			Min.	Typ.	Max.	
Gate - Source leakage current	I_{GSS}	$V_{GS} = \pm 20\text{V}, V_{DS} = 0\text{V}$	-	-	± 10	μA
Drain - Source breakdown voltage	$V_{(BR)DSS}$	$V_{GS} = 0\text{V}, I_D = 1\text{mA}$	30	-	-	V
Zero gate voltage drain current	I_{DSS}	$V_{DS} = 30\text{V}, V_{GS} = 0\text{V}$	-	-	1	μA
Gate threshold voltage	$V_{GS(th)}$	$V_{DS} = 10\text{V}, I_D = 1\text{mA}$	1.0	-	2.5	V
Static drain - source on - state resistance	$R_{DS(on)}^{*4}$	$V_{GS} = 10\text{V}, I_D = 1.4\text{A}$	-	170	240	m Ω
		$V_{GS} = 4.5\text{V}, I_D = 1.4\text{A}$	-	250	350	
		$V_{GS} = 4\text{V}, I_D = 1.4\text{A}$	-	270	380	
Forward Transfer Admittance	$ Y_{fs} ^{*4}$	$V_{DS} = 10\text{V}, I_D = 1.4\text{A}$	1	-	-	S

● **Electrical characteristics** ($T_a = 25^\circ\text{C}$)

< MOSFET >

Parameter	Symbol	Conditions	Values			Unit
			Min.	Typ.	Max.	
Input capacitance	C_{iss}	$V_{GS} = 0\text{V}$	-	70	-	pF
Output capacitance	C_{oss}	$V_{DS} = 10\text{V}$	-	15	-	
Reverse transfer capacitance	C_{rss}	$f = 1\text{MHz}$	-	12	-	
Turn - on delay time	$t_{d(on)}^{*4}$	$V_{DD} \approx 15\text{V}, V_{GS} = 10\text{V}$	-	6	-	ns
Rise time	t_r^{*4}	$I_D = 0.7\text{A}$	-	6	-	
Turn - off delay time	$t_{d(off)}^{*4}$	$R_L = 21\Omega$	-	13	-	
Fall time	t_f^{*4}	$R_G = 10\Omega$	-	8	-	

● **Gate charge characteristics** ($T_a = 25^\circ\text{C}$)

< MOSFET >

Parameter	Symbol	Conditions	Values			Unit
			Min.	Typ.	Max.	
Total gate charge	Q_g^{*4}	$V_{DD} \approx 15\text{V}, I_D = 1.4\text{A}$ $V_{GS} = 5\text{V}$	-	1.4	-	nC
Gate - Source charge	Q_{gs}^{*4}		-	0.6	-	
Gate - Drain charge	Q_{gd}^{*4}		-	0.3	-	

● **Body diode electrical characteristics** (Source-Drain) ($T_a = 25^\circ\text{C}$)

< MOSFET >

Parameter	Symbol	Conditions	Values			Unit
			Min.	Typ.	Max.	
Forward voltage	V_{SD}^{*4}	$V_{GS} = 0\text{V}, I_S = 1.4\text{A}$	-	-	1.2	V

● Electrical characteristics ($T_a = 25^\circ\text{C}$)

< Diode >

Parameter	Symbol	Conditions	Values			Unit
			Min.	Typ.	Max.	
Forward voltage	V_F	$I_F = 0.1\text{A}$	-	-	0.36	V
		$I_F = 0.5\text{A}$	-	-	0.52	V
Reverse current	I_R	$V_R = 20\text{V}$	-	-	100	μA

*1 $P_w \leq 0\mu\text{s}$, Duty cycle $\leq 1\%$

*2 Mounted on a ceramic board (30×30×0.8mm)

*3 60Hz·1cycle

*4 Pulsed

Not Recommended for New Designs

● Electrical characteristic curves <MOSFET>

Fig.1 Typical Output Characteristics(I)

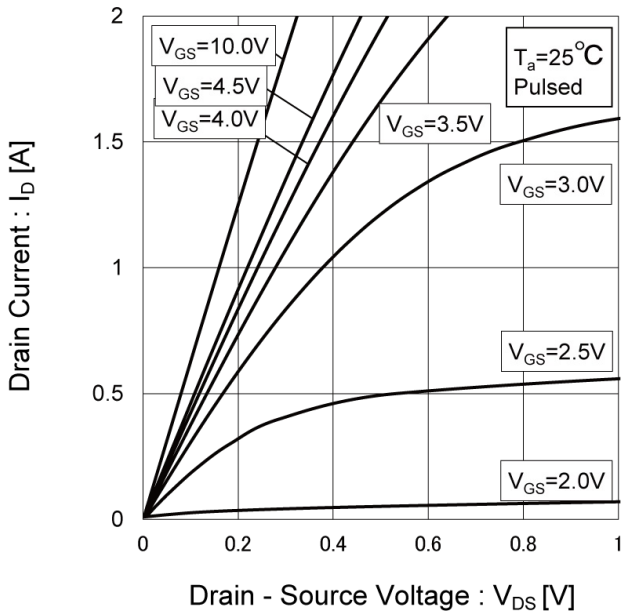

Fig.2 Typical Output Characteristics(II)

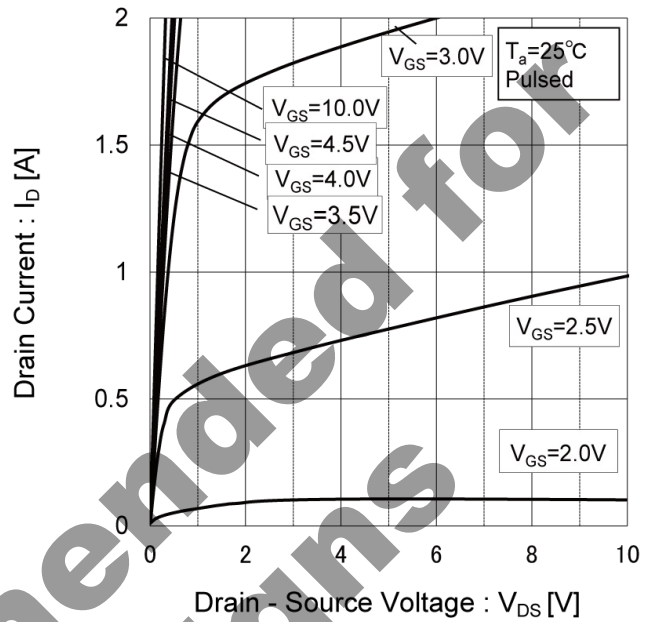

Fig.3 Breakdown Voltage vs. Junction Temperature

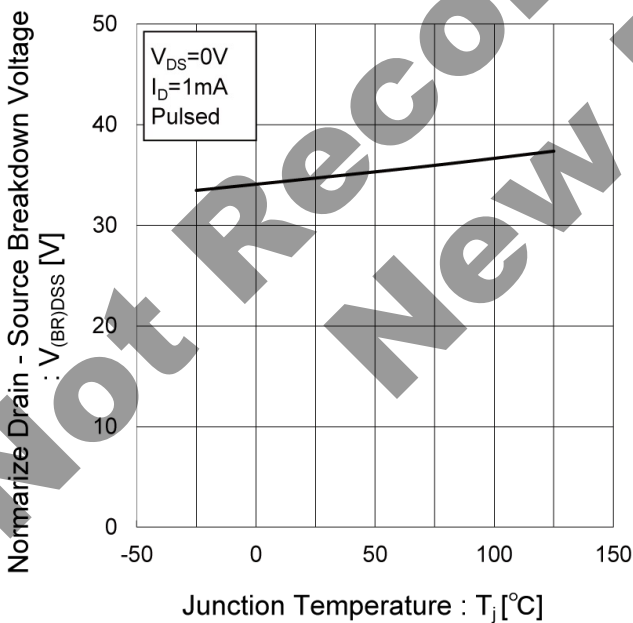
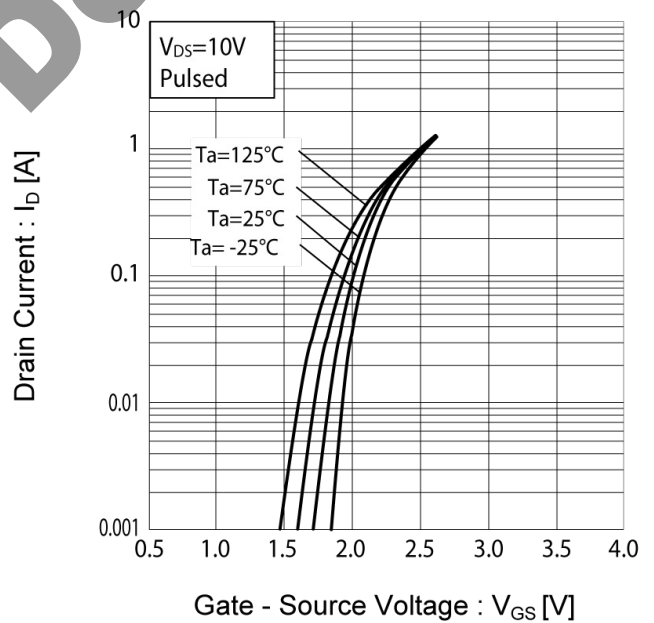

Fig.4 Typical Transfer Characteristics



● Electrical characteristic curves <MOSFET>

Fig.5 Gate Threshold Voltage vs. Junction Temperature

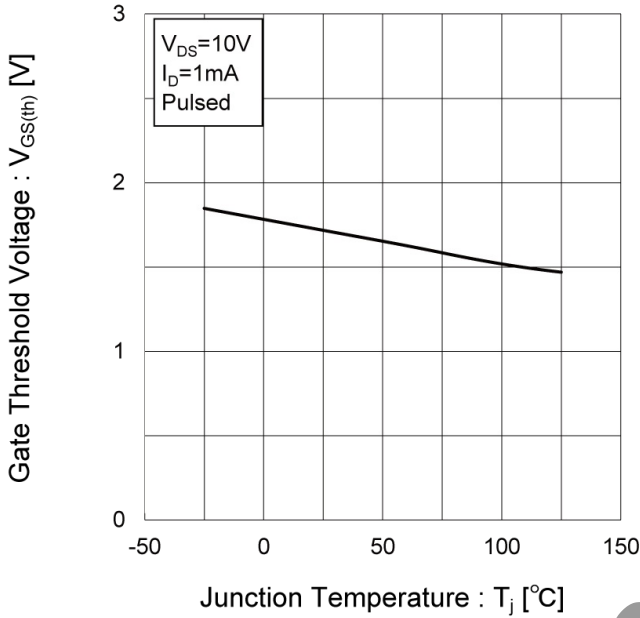

Fig.6 Forward Transfer Admittance vs. Drain Current

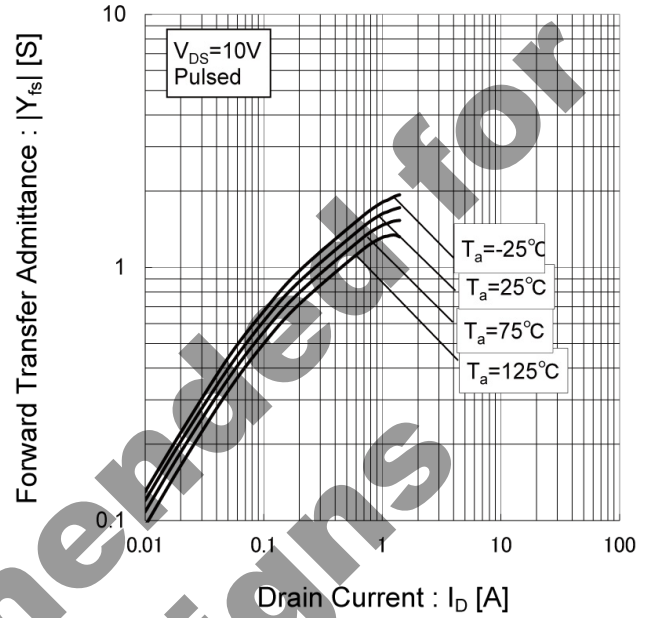

Fig.7 Drain Current Derating Curve

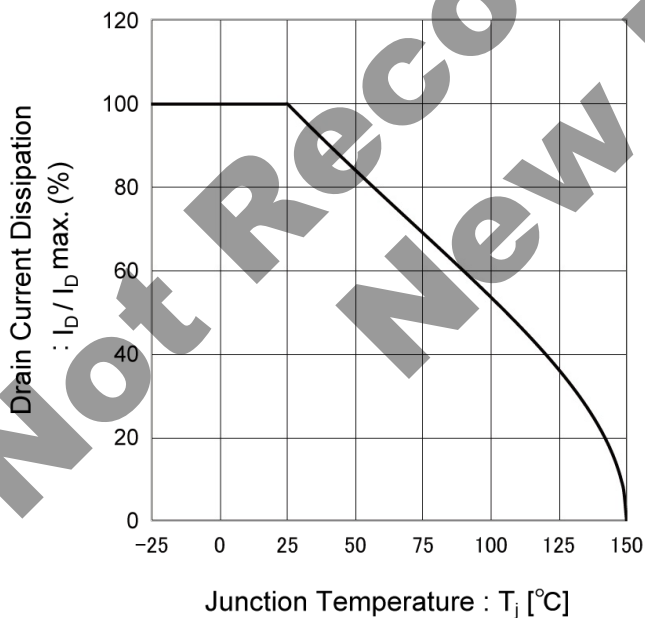
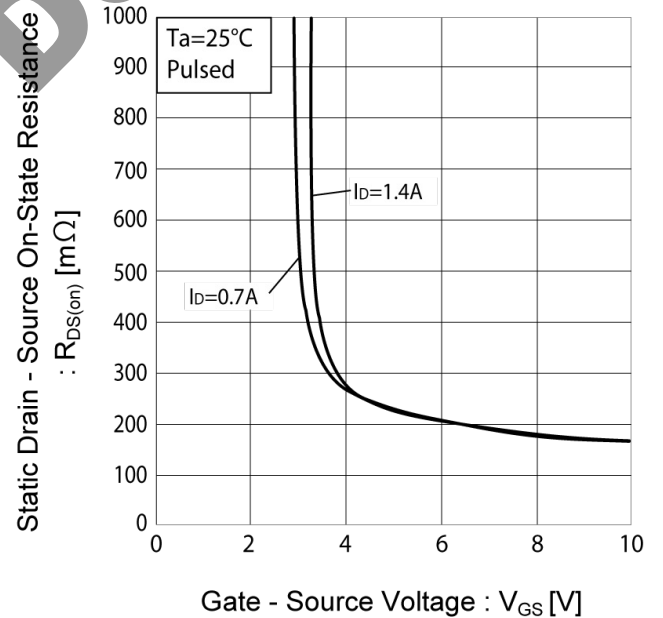

Fig.8 Static Drain - Source On - State Resistance vs. Gate Source Voltage



● Electrical characteristic curves <MOSFET>

Fig.9 Static Drain - Source On - State Resistance vs. Junction Temperature

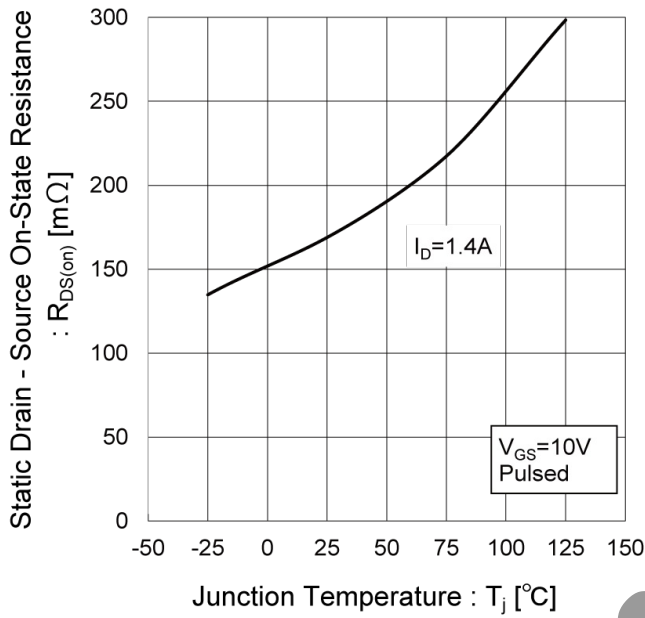
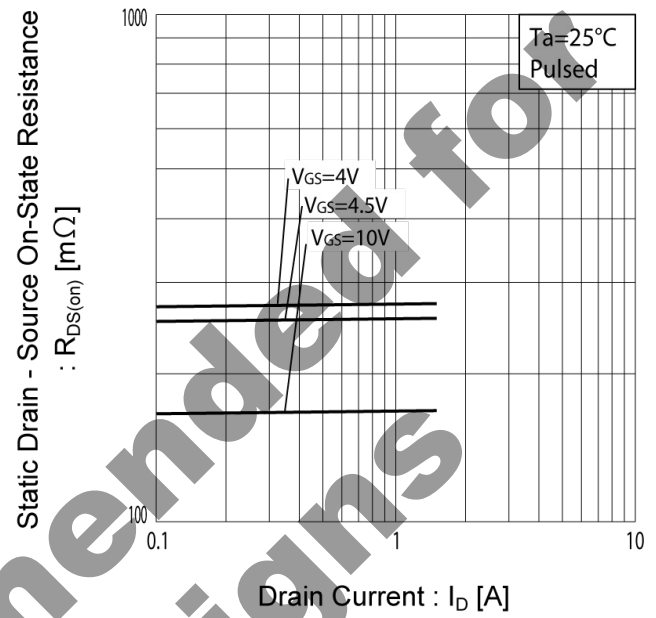

Fig.10 Static Drain - Source On - State Resistance vs. Drain Current (I)



Not Recommended for New Designs

● Electrical characteristic curves <MOSFET>

Fig.11 Static Drain - Source On - State Resistance vs. Drain Current (II)

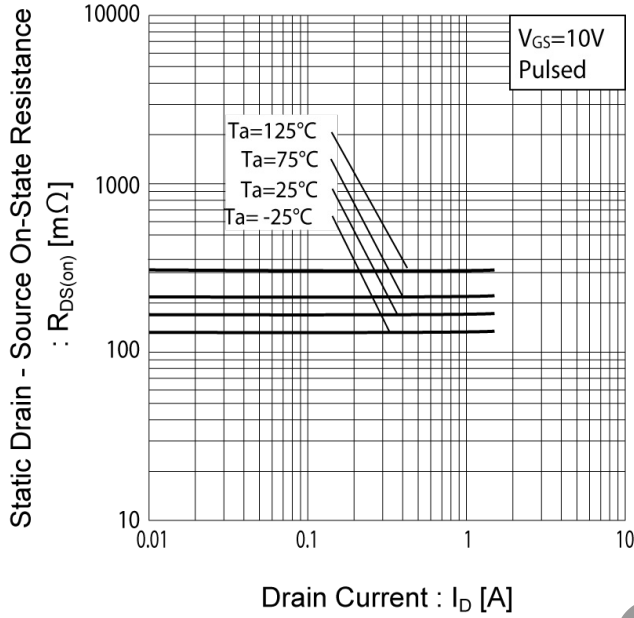

Fig.12 Static Drain - Source On - State Resistance vs. Drain Current (III)

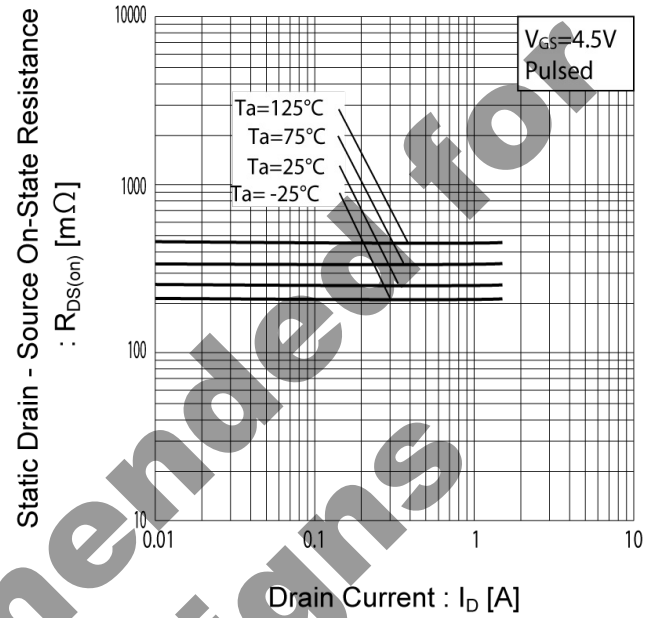
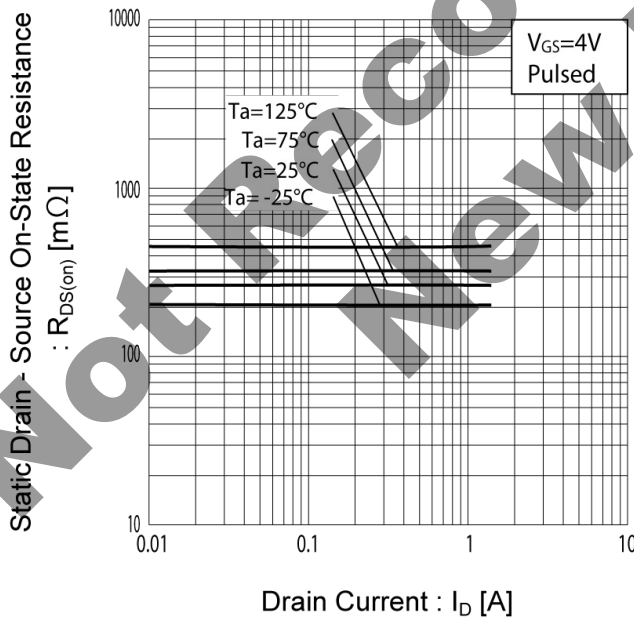

Fig.13 Static Drain - Source On - State Resistance vs. Drain Current (IV)



● Electrical characteristic curves <MOSFET>

Fig.14 Typical Capacitance vs. Drain - Source Voltage

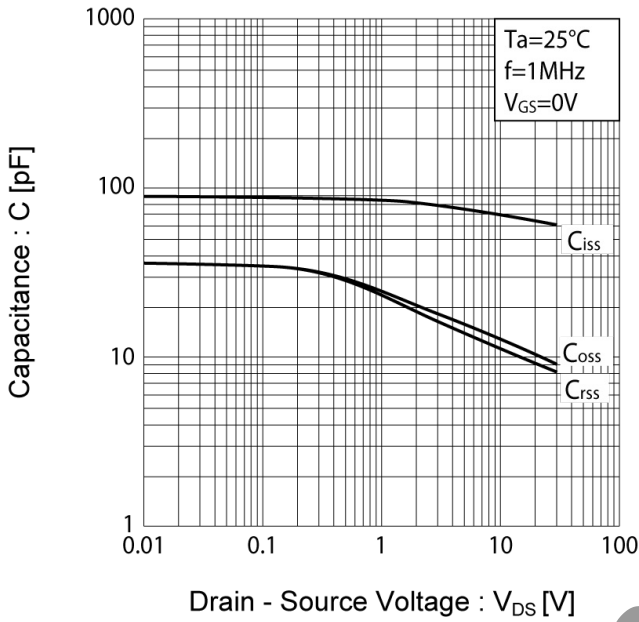

Fig.15 Switching Characteristics

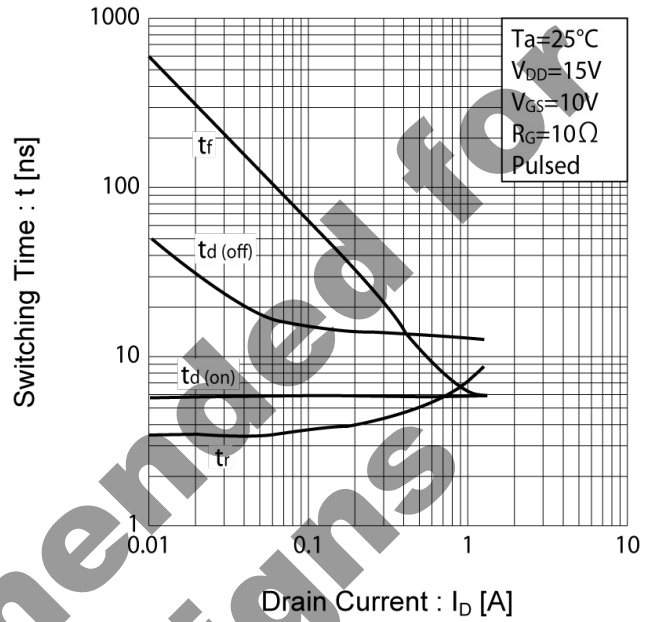

Fig.16 Dynamic Input Characteristics

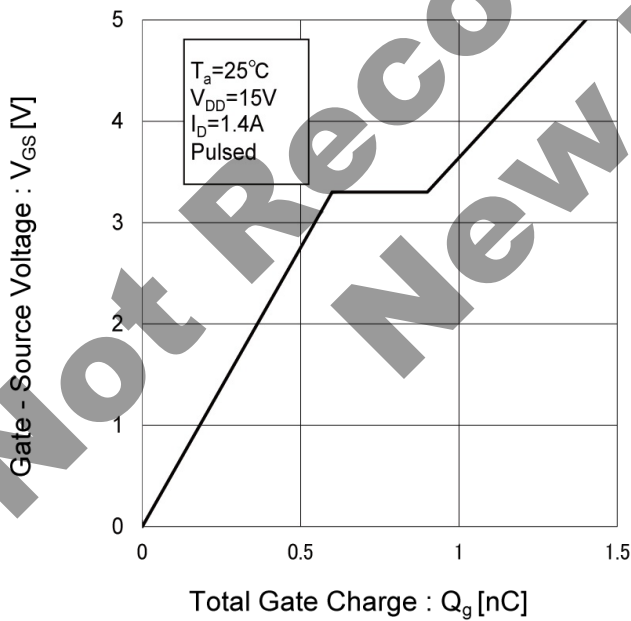
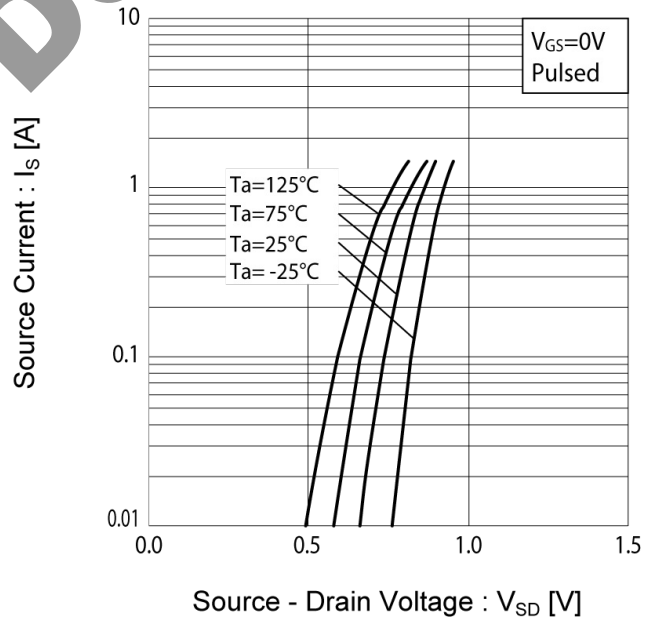

Fig.17 Source Current vs. Source Drain Voltage



● Electrical characteristic curves <Di>

Fig.18 Reverse Current vs. Reverse Voltage

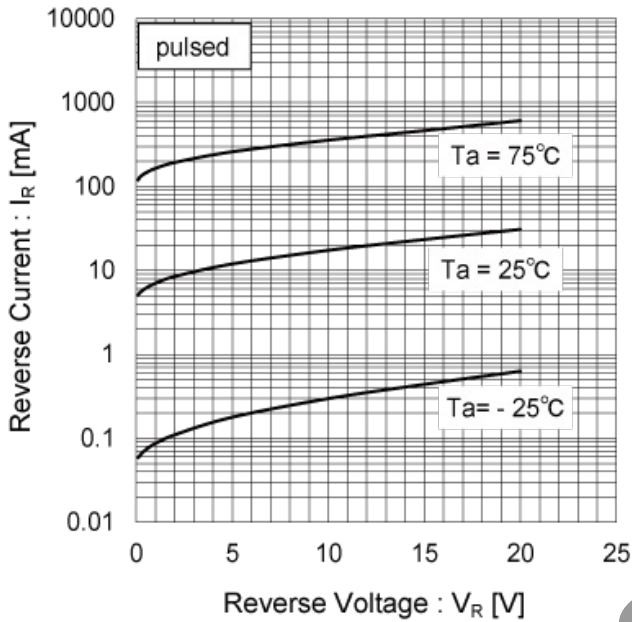
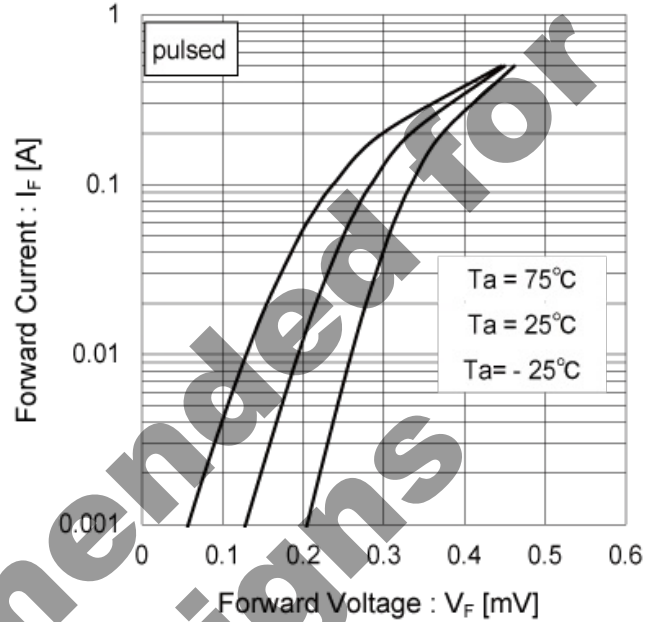

Fig.19 Forward Current vs. Forward Voltage



Not Recommended for New Designs

● Measurement circuits

Fig. 1-1 SWITCHING TIME MEASUREMENT CIRCUIT

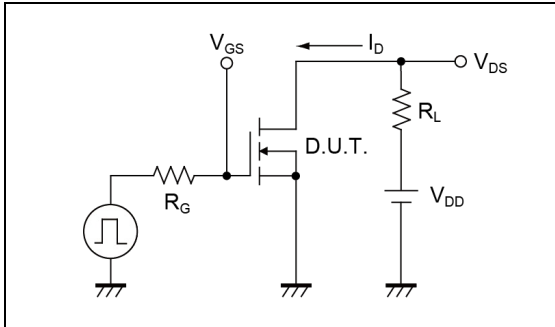

Fig. 1-2 SWITCHING WAVEFORMS

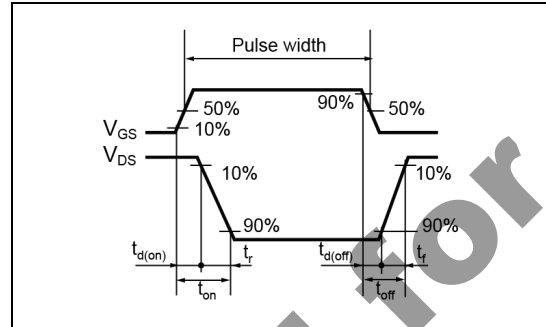

Fig. 2-1 GATE CHARGE MEASUREMENT CIRCUIT

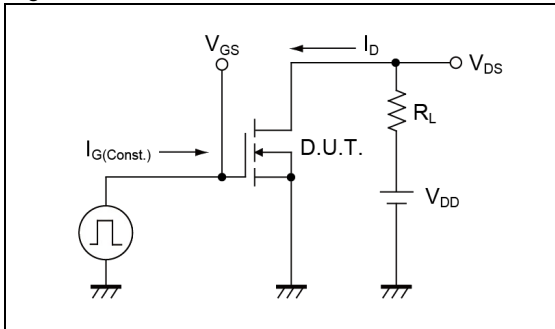
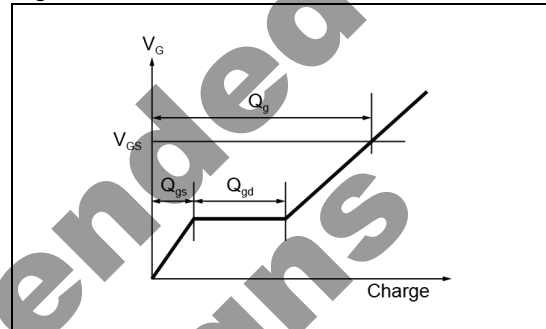

Fig. 2-2 GATE CHARGE WAVEFORM



● Notice

1. SBD has a large reverse leak current compared to other type of diode. Therefore, it would raise a junction temperature, and increase a reverse power loss. Further rise of inside temperature would cause a thermal runaway. This built-in SBD has low V_F characteristics and therefore, higher leak current. Please consider enough the surrounding temperature, generating heat of MOSFET and the reverse current.
2. This product might cause chip aging and breakdown under the large electrified environment. Please consider to design ESD protection circuit.

●Dimensions

SOT-563T
(WEMT6)

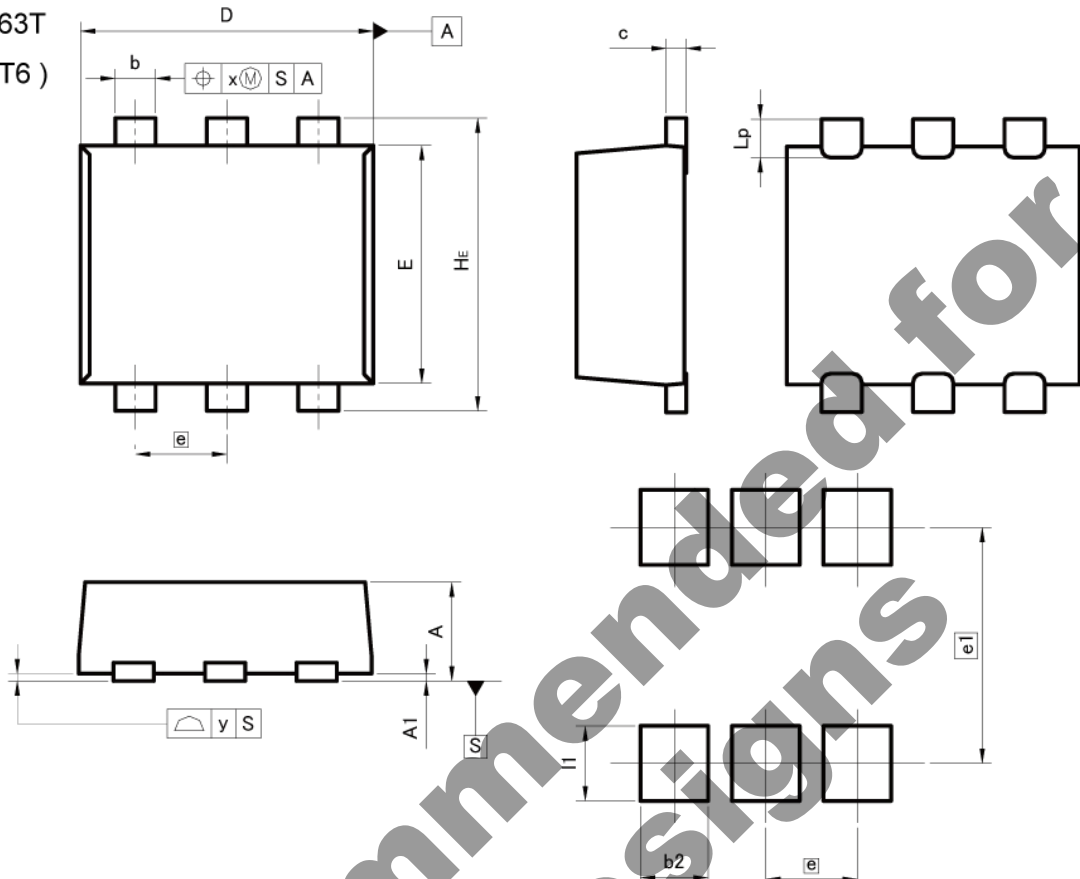

Pattern of terminal position areas
[Not a pattern of soldering pads]

DIM	MILIMETERS		INCHES	
	MIN	MAX	MIN	MAX
A	0.55	0.65	0.022	0.026
A1	0.00	0.05	0.000	0.002
b	0.17	0.27	0.007	0.011
c	0.08	0.18	0.003	0.007
D	1.50	1.70	0.059	0.067
E	1.20	1.40	0.047	0.055
e	0.50		0.020	
HE	1.50	1.70	0.059	0.067
Lp	0.11	0.31	0.004	0.012
x	-	0.10	-	0.004
y	-	0.10	-	0.004

DIM	MILIMETERS		INCHES	
	MIN	MAX	MIN	MAX
b2	-	0.37	-	0.015
e1	1.29		0.051	
l1	-	0.41	-	0.016

Dimension in mm/inches

Notice

Precaution on using ROHM Products

- Our Products are designed and manufactured for application in ordinary electronic equipments (such as AV equipment, OA equipment, telecommunication equipment, home electronic appliances, amusement equipment, etc.). If you intend to use our Products in devices requiring extremely high reliability (such as medical equipment ^(Note 1), transport equipment, traffic equipment, aircraft/spacecraft, nuclear power controllers, fuel controllers, car equipment including car accessories, safety devices, etc.) and whose malfunction or failure may cause loss of human life, bodily injury or serious damage to property ("Specific Applications"), please consult with the ROHM sales representative in advance. Unless otherwise agreed in writing by ROHM in advance, ROHM shall not be in any way responsible or liable for any damages, expenses or losses incurred by you or third parties arising from the use of any ROHM's Products for Specific Applications.

(Note1) Medical Equipment Classification of the Specific Applications

JAPAN	USA	EU	CHINA
CLASS III	CLASS III	CLASS II b	CLASS III
CLASS IV		CLASS III	

- ROHM designs and manufactures its Products subject to strict quality control system. However, semiconductor products can fail or malfunction at a certain rate. Please be sure to implement, at your own responsibilities, adequate safety measures including but not limited to fail-safe design against the physical injury, damage to any property, which a failure or malfunction of our Products may cause. The following are examples of safety measures:
 - Installation of protection circuits or other protective devices to improve system safety
 - Installation of redundant circuits to reduce the impact of single or multiple circuit failure
- Our Products are designed and manufactured for use under standard conditions and not under any special or extraordinary environments or conditions, as exemplified below. Accordingly, ROHM shall not be in any way responsible or liable for any damages, expenses or losses arising from the use of any ROHM's Products under any special or extraordinary environments or conditions. If you intend to use our Products under any special or extraordinary environments or conditions (as exemplified below), your independent verification and confirmation of product performance, reliability, etc. prior to use, must be necessary:
 - Use of our Products in any types of liquid, including water, oils, chemicals, and organic solvents
 - Use of our Products outdoors or in places where the Products are exposed to direct sunlight or dust
 - Use of our Products in places where the Products are exposed to sea wind or corrosive gases, including Cl₂, H₂S, NH₃, SO₂, and NO₂
 - Use of our Products in places where the Products are exposed to static electricity or electromagnetic waves
 - Use of our Products in proximity to heat-producing components, plastic cords, or other flammable items
 - Sealing or coating our Products with resin or other coating materials
 - Use of our Products without cleaning residue of flux (even if you use no-clean type fluxes, cleaning residue of flux is recommended); or Washing our Products by using water or water-soluble cleaning agents for cleaning residue after soldering
 - Use of the Products in places subject to dew condensation
- The Products are not subject to radiation-proof design.
- Please verify and confirm characteristics of the final or mounted products in using the Products.
- In particular, if a transient load (a large amount of load applied in a short period of time, such as pulse. is applied, confirmation of performance characteristics after on-board mounting is strongly recommended. Avoid applying power exceeding normal rated power; exceeding the power rating under steady-state loading condition may negatively affect product performance and reliability.
- De-rate Power Dissipation depending on ambient temperature. When used in sealed area, confirm that it is the use in the range that does not exceed the maximum junction temperature.
- Confirm that operation temperature is within the specified range described in the product specification.
- ROHM shall not be in any way responsible or liable for failure induced under deviant condition from what is defined in this document.

Precaution for Mounting / Circuit board design

- When a highly active halogenous (chlorine, bromine, etc.) flux is used, the residue of flux may negatively affect product performance and reliability.
- In principle, the reflow soldering method must be used on a surface-mount products, the flow soldering method must be used on a through hole mount products. If the flow soldering method is preferred on a surface-mount products, please consult with the ROHM representative in advance.

For details, please refer to ROHM Mounting specification

Precautions Regarding Application Examples and External Circuits

1. If change is made to the constant of an external circuit, please allow a sufficient margin considering variations of the characteristics of the Products and external components, including transient characteristics, as well as static characteristics.
2. You agree that application notes, reference designs, and associated data and information contained in this document are presented only as guidance for Products use. Therefore, in case you use such information, you are solely responsible for it and you must exercise your own independent verification and judgment in the use of such information contained in this document. ROHM shall not be in any way responsible or liable for any damages, expenses or losses incurred by you or third parties arising from the use of such information.

Precaution for Electrostatic

This Product is electrostatic sensitive product, which may be damaged due to electrostatic discharge. Please take proper caution in your manufacturing process and storage so that voltage exceeding the Products maximum rating will not be applied to Products. Please take special care under dry condition (e.g. Grounding of human body / equipment / solder iron, isolation from charged objects, setting of Ionizer, friction prevention and temperature / humidity control).

Precaution for Storage / Transportation

1. Product performance and soldered connections may deteriorate if the Products are stored in the places where:
 - [a] the Products are exposed to sea winds or corrosive gases, including Cl₂, H₂S, NH₃, SO₂, and NO₂
 - [b] the temperature or humidity exceeds those recommended by ROHM
 - [c] the Products are exposed to direct sunshine or condensation
 - [d] the Products are exposed to high Electrostatic
2. Even under ROHM recommended storage condition, solderability of products out of recommended storage time period may be degraded. It is strongly recommended to confirm solderability before using Products of which storage time is exceeding the recommended storage time period.
3. Store / transport cartons in the correct direction, which is indicated on a carton with a symbol. Otherwise bent leads may occur due to excessive stress applied when dropping of a carton.
4. Use Products within the specified time after opening a humidity barrier bag. Baking is required before using Products of which storage time is exceeding the recommended storage time period.

Precaution for Product Label

A two-dimensional barcode printed on ROHM Products label is for ROHM's internal use only.

Precaution for Disposition

When disposing Products please dispose them properly using an authorized industry waste company.

Precaution for Foreign Exchange and Foreign Trade act

Since concerned goods might be fallen under listed items of export control prescribed by Foreign exchange and Foreign trade act, please consult with ROHM in case of export.

Precaution Regarding Intellectual Property Rights

1. All information and data including but not limited to application example contained in this document is for reference only. ROHM does not warrant that foregoing information or data will not infringe any intellectual property rights or any other rights of any third party regarding such information or data.
2. ROHM shall not have any obligations where the claims, actions or demands arising from the combination of the Products with other articles such as components, circuits, systems or external equipment (including software).
3. No license, expressly or implied, is granted hereby under any intellectual property rights or other rights of ROHM or any third parties with respect to the Products or the information contained in this document. Provided, however, that ROHM will not assert its intellectual property rights or other rights against you or your customers to the extent necessary to manufacture or sell products containing the Products, subject to the terms and conditions herein.

Other Precaution

1. This document may not be reprinted or reproduced, in whole or in part, without prior written consent of ROHM.
2. The Products may not be disassembled, converted, modified, reproduced or otherwise changed without prior written consent of ROHM.
3. In no event shall you use in any way whatsoever the Products and the related technical information contained in the Products or this document for any military purposes, including but not limited to, the development of mass-destruction weapons.
4. The proper names of companies or products described in this document are trademarks or registered trademarks of ROHM, its affiliated companies or third parties.

Mouser Electronics

Authorized Distributor

Click to View Pricing, Inventory, Delivery & Lifecycle Information:

[ROHM Semiconductor:](#)

[ES6U3T2CR](#)



Компания «ЭлектроПласт» предлагает заключение долгосрочных отношений при поставках импортных электронных компонентов на взаимовыгодных условиях!

Наши преимущества:

- Оперативные поставки широкого спектра электронных компонентов отечественного и импортного производства напрямую от производителей и с крупнейших мировых складов;
- Поставка более 17-ти миллионов наименований электронных компонентов;
- Поставка сложных, дефицитных, либо снятых с производства позиций;
- Оперативные сроки поставки под заказ (от 5 рабочих дней);
- Экспресс доставка в любую точку России;
- Техническая поддержка проекта, помощь в подборе аналогов, поставка прототипов;
- Система менеджмента качества сертифицирована по Международному стандарту ISO 9001;
- Лицензия ФСБ на осуществление работ с использованием сведений, составляющих государственную тайну;
- Поставка специализированных компонентов (Xilinx, Altera, Analog Devices, Intersil, Interpoint, Microsemi, Aeroflex, Peregrine, Syfer, Eurofarad, Texas Instrument, Miteq, Cobham, E2V, MA-COM, Hittite, Mini-Circuits, General Dynamics и др.);

Помимо этого, одним из направлений компании «ЭлектроПласт» является направление «Источники питания». Мы предлагаем Вам помощь Конструкторского отдела:

- Подбор оптимального решения, техническое обоснование при выборе компонента;
- Подбор аналогов;
- Консультации по применению компонента;
- Поставка образцов и прототипов;
- Техническая поддержка проекта;
- Защита от снятия компонента с производства.



Как с нами связаться

Телефон: 8 (812) 309 58 32 (многоканальный)

Факс: 8 (812) 320-02-42

Электронная почта: org@eplast1.ru

Адрес: 198099, г. Санкт-Петербург, ул. Калинина, дом 2, корпус 4, литера А.