

# Ultra-compact EMC/RFI Filter for Motor Drives Applications



- New: solid safety connector blocks available for the whole range
- Exceptional attenuation performance from 150 kHz to 30 MHz
- Excellent saturation resistance up to 50 m cable length
- Most compact and slim filter design in its class



### Performance indicators

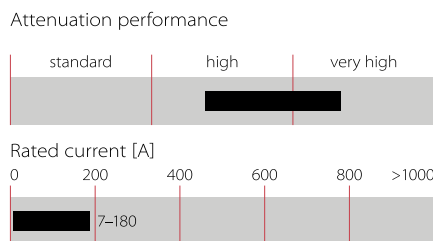

## Technical specifications

<b>Maximum continuous operating voltage</b>	3x 480/277 VAC (FN 3258) 3x 520/300 VAC (FN 3258 H)
<b>Operating frequency</b>	DC to 60 Hz
<b>Rated currents</b>	7 to 180 A @ 50°C
<b>High potential test voltage</b>	P → E 2650 / 2750 VDC for 2 sec (FN 3258 / FN 3258H) P → P 2100 / 2250 VDC for 2 sec (FN 3258 / FN 3258H)
<b>Protection category</b>	IP 20
<b>Overload capability</b>	1.5x rated current for 1 minute, once per hour 4x rated current at switch on,
<b>Temperature range (operation and storage)</b>	-25°C to +100°C (25/100/21)
<b>Flammability corresponding to</b>	UL 94 V-2 or better
<b>Design corresponding to</b>	UL 1283, CSA 22.2 No. 8 1986, IEC/EN 60939
<b>MTBF @ 50°C/400 V (Mil-HB-217F)</b>	300,000 hours

### Approvals



### Features and benefits

- The extremely compact and slim filter design allows a trouble-free installation even where the available mounting space is minimal
- With new additional filter types providing safety terminal blocks, the most preferred connection style can be chosen fast and easy. This helps to stay in line with the electrical connection concept of a given application
- FN 3258 filters ensure compliance with Class A limits according to EN 55011 up to 50 m cable length and beyond. Further they can contribute significantly to meet conducted emission limits according to Class B
- Filter operation on the mains input side of consumers increases their reliability and conducted immunity significant
- Chokes with exceptional saturation resistance and excellent thermal behavior are a vital part of FN 3258 design. Thus, all filters retain the expected filter performance even in very noisy applications and under full load conditions

### Typical applications

- Three-phase variable speed motor drives, servo drives, inverters and converters
- Applications comprising energy conversion devices like machines or process automation equipment
- HVAC equipment, elevators, power supplies, UPS and further three-phase applications

### Typical electrical schematic

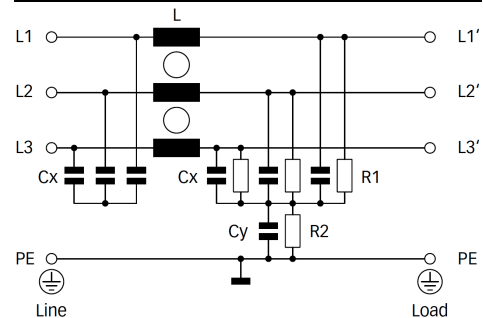

### Filter selection table

Filter	Rated current @ 50°C (40°C) [A]	Typical drive power rating* [kW]	Leakage current** @ 480/520 VAC/50 Hz [mA]	Power loss @ 25°C/50 Hz [W]	Input/Output connections 	Weight [kg]
<b>FN 3258-7-44</b>	7 (7.7)	4	4.3	3.8	-44	0.5
<b>FN 3258-16-44</b>	16 (17.5)	7.5	4.3	6.1	-44	0.8
<b>FN 3258-30-33</b>	30 (32.9)	15	4.3	11.8	-33	1.2
<b>FN 3258-42-33</b>	42 (46.0)	22	4.3	15.7	-33	1.4
<b>FN 3258-55-34</b>	55 (60.2)	30	4.3	25.9	-34	2.0
<b>FN 3258-75-34</b>	75 (82.2)	37	4.3	32.2	-34	2.7
<b>FN 3258-100-35</b>	100 (109.5)	55	4.3	34.5	-35	4.3
<b>FN 3258-130-35</b>	130 (142.4)	75	4.3	43.1	-35	4.5
<b>FN 3258-180-40</b>	180 (197.1)	90	4.3	58.3	-40	6.0
<b>FN 3258 H-7-44</b>	7 (7.7)	4	4.7	3.8	-44	0.5
<b>FN 3258 H-16-44</b>	16 (17.5)	7.5	4.7	6.1	-44	0.8
<b>FN 3258 H-30-33</b>	30 (32.9)	18.5	4.7	11.8	-33	1.2
<b>FN 3258 H-42-33</b>	42 (46.0)	22	4.7	15.7	-33	1.4
<b>FN 3258 H-55-34</b>	55 (60.2)	37	4.7	25.9	-34	2.0
<b>FN 3258 H-75-34</b>	75 (82.2)	45	4.7	32.2	-34	2.7
<b>FN 3258 H-100-35</b>	100 (109.5)	55	4.7	34.5	-35	4.3
<b>FN 3258 H-130-35</b>	130 (142.4)	75	4.7	43.1	-35	4.5
<b>FN 3258 H-180-40</b>	180 (197.1)	110	4.7	58.3	-40	6.0

\* Calculated at rated current, 440 VAC (FN 3258)/480 VAC (FN 3258 H) and cos phi=0.8. The exact value depends upon the efficiency of the drive, the motor and the entire application.

\*\* Standardized calculated leakage current acc. IEC60939 under normal operating conditions (FN 3258 at 480 VAC and FN 3258H at 520 VAC).

### Typical filter attenuation

Per CISPR 17; A=50/50 sym; B=50/50 asym; C=0.1/100 sym; D=100/0.1 sym

7 to 42 A types

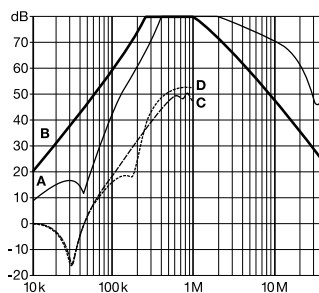

55 to 100 A types

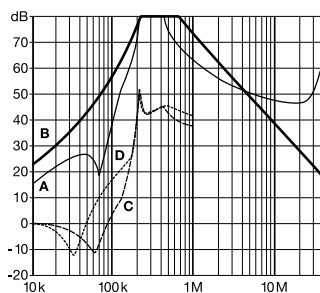

130 and 180 A types

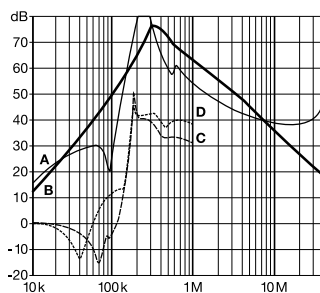

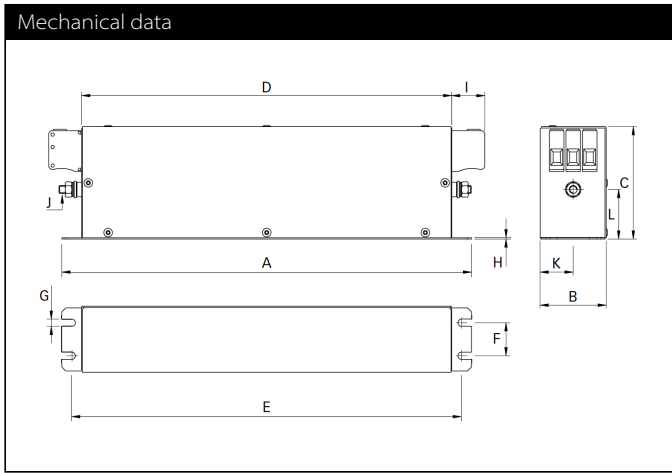

Note: in favour of a better readability, connectors and earth studs are not shown in the horizontal projection.

## Dimensions

	7 A	16 A	30 A	42 A	55 A	75 A	100 A	130 A	180 A
<b>A</b>	190	250	270	310	250	270	270	270	380
<b>B</b>	40	45	50	50	85	80	90	90	120
<b>C</b>	70	70	85	85	90	135	150	150	170
<b>D</b>	160	220	240	280	220	240	240	240	350
<b>E</b>	180	235	255	295	235	255	255	255	365
<b>F</b>	20	25	30	30	60	60	65	65	102
<b>G</b>	4.5	5.4	5.4	5.4	5.4	6.5	6.5	6.5	6.5
<b>H</b>	1	1	1	1	1	1.5	1.5	1.5	1.5
<b>I</b>	22	22	25	25	39	39	45	45	51
<b>J</b>	M5	M5	M5	M6	M6	M6	M10	M10	M10
<b>K</b>	20	22.5	25	25	42.5	40	45	45	60
<b>L2</b>	29.5	29.5	39.5	37.5	26.5	70.5	64	64	47

All dimensions in mm; 1 inch = 25.4 mm

Tolerances according: ISO 2768-m/EN 22768-m

## Filter input/output connector cross sections

	-33	-34	-35	-40	-44
<b>Solid wire</b>	16 mm <sup>2</sup>	35 mm <sup>2</sup>	50 mm <sup>2</sup>	95 mm <sup>2</sup>	10 mm <sup>2</sup>
<b>Flex wire</b>	10 mm <sup>2</sup>	25 mm <sup>2</sup>	50 mm <sup>2</sup>	95 mm <sup>2</sup>	6 mm <sup>2</sup>
<b>AWG type wire</b>	AWG 6	AWG 2	AWG 1/0	AWG 4/0	AWG 8
<b>Recommended torque</b>	1.5-1.8 Nm	4.0-4.5 Nm	7-8 Nm	17-20 Nm	1.5-1.8 Nm

Please visit [www.schaffner.com](http://www.schaffner.com) to find more details on filter connectors.



## Headquarters, global innovation and development

### Switzerland

#### Schaffner Group

Nordstrasse 11  
4542 Luterbach  
T +41 32 681 66 26  
[info@schaffner.com](mailto:info@schaffner.com)  
[www.schaffner.com](http://www.schaffner.com)



## Sales and application centers

### China

#### Schaffner EMC Ltd. Shanghai

T20-3 C, No 565 Chuangye Road,  
Pudong district  
201201 Shanghai  
T +86 21 3813 9500  
[cschina@schaffner.com](mailto:cschina@schaffner.com)  
[www.schaffner.com.cn](http://www.schaffner.com.cn)

### Finland

#### Schaffner Oy

Sauvonrinne 19 H  
08500 Lohja  
T +358 50 468 7284  
[finlandsales@schaffner.com](mailto:finlandsales@schaffner.com)

### France

#### Schaffner EMC S.A.S.

16-20 Rue Louis Rameau  
95875 Bezons  
T +33 1 34 34 30 60  
F +33 1 39 47 02 28  
[francesales@schaffner.com](mailto:francesales@schaffner.com)

### Germany

#### Schaffner Deutschland GmbH

Schoemperlenstrasse 12B  
76185 Karlsruhe  
T +49 721 56910  
F +49 721 569110  
[germanysales@schaffner.com](mailto:germanysales@schaffner.com)

### India

#### Schaffner India Pvt. Ltd

REGUS WORLD TRADE CENTRE  
WTC, 22nd Floor Unit No 2238, Brigade  
Gateway Campus, 26/1, Dr. Rajkumar Road  
Malleswaram (W)  
560055 Bangalore  
T +91 80 67935355  
[indiasales@schaffner.com](mailto:indiasales@schaffner.com)

### Italy

#### Schaffner EMC S.r.l.

Via Ticino, 30  
20900 Monza (MB)  
T +39 039 21 41 070  
[italysales@schaffner.com](mailto:italysales@schaffner.com)

### Japan

#### Schaffner EMC K.K.

1-32-12, Kamiyama, Setagaya-ku  
7F Mitsui-seimei Sangenjaya Bldg.  
154-0011 Tokyo  
T +81 3 5712 3650  
F +81 3 5712 3651  
[japansales@schaffner.com](mailto:japansales@schaffner.com)  
[www.schaffner.jp](http://www.schaffner.jp)

### Singapore

#### Schaffner EMC Pte Ltd.

#05-09, Kg Ubi Ind. Estate  
408705 Singapore  
T +65 6377 3283  
F +65 6377 3281  
[singaporesales@schaffner.com](mailto:singaporesales@schaffner.com)

### Spain

#### Schaffner EMC España

Calle Caléndula 93, Miniparc III, Edificio E  
El Soto de Moraleja, Alcobendas  
28109 Madrid  
T +34 917 912 900  
F +34 917 912 901  
[spainsales@schaffner.com](mailto:spainsales@schaffner.com)

### Sweden

#### Schaffner EMC AB

Tegeluddsvägen 76, 2tr  
115 28 Stockholm  
T +46 8 5050 2425  
[swedensales@schaffner.com](mailto:swedensales@schaffner.com)  
[www.schaffner.com](http://www.schaffner.com)

### Switzerland

#### Schaffner EMV AG

Nordstrasse 11  
4542 Luterbach  
T +41 32 681 66 26  
[switzerlandsales@schaffner.com](mailto:switzerlandsales@schaffner.com)

### Taiwan R.O.C.

#### Schaffner EMV Ltd.

20 Floor-2, No 97, Section 1, XinTai 5th Road  
22175 XiZhi District New Taipei City 22175  
T +886 2 2697 5500  
F +886 2 2697 5533  
[taiwansales@schaffner.com](mailto:taiwansales@schaffner.com)  
[www.schaffner.com.tw](http://www.schaffner.com.tw)

### Thailand

#### Schaffner EMC Co. Ltd.

Northern Region Industrial Estate  
67 Moo 4 Tambon Ban Klang  
Amphur Muangng P.O. Box 14  
51000 Lamphun  
T +66 53 58 11 04  
F +66 53 58 10 19  
[thailandsales@schaffner.com](mailto:thailandsales@schaffner.com)

### United Kingdom

#### Schaffner Ltd.

5 Ashville Way, Molly Millars Lane  
Wokingham  
RG41 2PL Berkshire  
T +44 118 9770070  
F +44 118 9792969  
[uksales@schaffner.com](mailto:uksales@schaffner.com)

### USA

#### Schaffner EMC Inc.

52 Mayfield Avenue  
08837 Edison, New Jersey  
T +1 800 367 5566  
T +1 732 225 9533  
F +1 732 225 4789  
[usasales@schaffner.com](mailto:usasales@schaffner.com)  
[www.schaffnerusa.com](http://www.schaffnerusa.com)

#### Schaffner North America

6722 Thirlane Road  
24019 Roanoke, Virginia  
T +1 276 228 7943  
F +1 276 228 7953

#### Schaffner North America

823 Fairview Road  
24382 Wytheville, Virginia  
T +1 276 228 7943  
F +1 276 228 7258

To find your local partner within Schaffner's global network: [www.schaffner.com](http://www.schaffner.com)

© 2018 Schaffner Group

The content of this document has been carefully checked and understood. However, neither Schaffner nor its subsidiaries assume any liability whatsoever for any errors or inaccuracies of this document and the consequences thereof. Published specifications are subject to change without notice. Product suitability for any area of application must ultimately be determined by the customer. In all cases, products must never be operated outside their published specifications. Schaffner does not guarantee the availability of all published products. This disclaimer shall be governed by substantive Swiss law and resulting disputes shall be settled by the courts at the place of business of Schaffner Holding AG. Latest publications and a complete disclaimer can be downloaded from the Schaffner website. All trademarks recognized.



Компания «ЭлектроПласт» предлагает заключение долгосрочных отношений при поставках импортных электронных компонентов на взаимовыгодных условиях!

Наши преимущества:

- Оперативные поставки широкого спектра электронных компонентов отечественного и импортного производства напрямую от производителей и с крупнейших мировых складов;
- Поставка более 17-ти миллионов наименований электронных компонентов;
- Поставка сложных, дефицитных, либо снятых с производства позиций;
- Оперативные сроки поставки под заказ (от 5 рабочих дней);
- Экспресс доставка в любую точку России;
- Техническая поддержка проекта, помощь в подборе аналогов, поставка прототипов;
- Система менеджмента качества сертифицирована по Международному стандарту ISO 9001;
- Лицензия ФСБ на осуществление работ с использованием сведений, составляющих государственную тайну;
- Поставка специализированных компонентов (Xilinx, Altera, Analog Devices, Intersil, Interpoint, Microsemi, Aeroflex, Peregrine, Syfer, Eurofarad, Texas Instrument, Miteq, Cobham, E2V, MA-COM, Hittite, Mini-Circuits, General Dynamics и др.);

Помимо этого, одним из направлений компании «ЭлектроПласт» является направление «Источники питания». Мы предлагаем Вам помощь Конструкторского отдела:

- Подбор оптимального решения, техническое обоснование при выборе компонента;
- Подбор аналогов;
- Консультации по применению компонента;
- Поставка образцов и прототипов;
- Техническая поддержка проекта;
- Защита от снятия компонента с производства.



#### Как с нами связаться

**Телефон:** 8 (812) 309 58 32 (многоканальный)

**Факс:** 8 (812) 320-02-42

**Электронная почта:** [org@eplast1.ru](mailto:org@eplast1.ru)

**Адрес:** 198099, г. Санкт-Петербург, ул. Калинина, дом 2, корпус 4, литера А.