

# Snap Action Switch D2F

## Subminiature Snap Action Switch

- Switches 3 A loads (general-purpose), 1 A loads (low force general-purpose) and 0.1 A loads (microvoltage/microcurrent)
- Long life span assured by high-precision dual spring reverse-action mechanism
- Flux penetration prevented by using an insert terminal and allowing a height difference at the case bottom
- Ideal for a wide range of applications including appliances, office equipment, audio and communications equipment
- RoHS Compliant

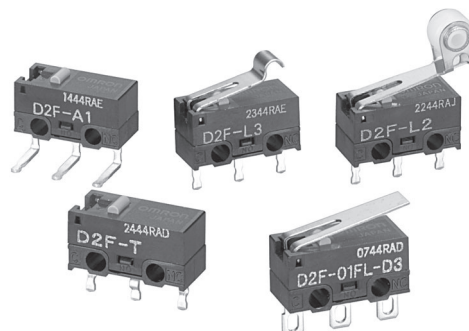

## Ordering Information

| Actuator | Contact type         | Model     | Contact OF | Model         |                 |              |                |             |              |
|----------|----------------------|-----------|------------|---------------|-----------------|--------------|----------------|-------------|--------------|
|          |                      |           |            | Terminal type |                 |              |                |             |              |
|          |                      |           |            | PCB           | Self-supporting | Solder       | Compact Solder | Right-angle | Left-angle   |
|          | Microvoltage/current | Low force | 75 g       | D2F-01F       | D2F-01F-T       | D2F-01F-D3   | D2F-01F-D      | D2F-01F-A   | D2F-01F-A1   |
|          |                      | Standard  | 150 g      | D2F-01        | D2F-01-T        | D2F-01-D3    | D2F-01-D       | D2F-01-A    | D2F-01-A1    |
|          | General-purpose      | Low force | 75 g       | D2F-F         | D2F-F-T         | D2F-F-D3     | D2F-F-D        | D2F-F-A     | D2F-F-A1     |
|          |                      | Standard  | 150 g      | D2F           | D2F-T           | D2F-D3       | D2F-D          | D2F-A       | D2F-A1       |
|          | Microvoltage/current | Low force | 25 g       | D2F-01FL      | D2F-01FL-T      | D2F-01FL-D3  | D2F-01FL-D     | D2F-01FL-A  | D2F-01FL-A1  |
|          |                      | Standard  | 80 g       | D2F-01L       | D2F-01L-T       | D2F-01L-D3   | D2F-01L-D      | D2F-01L-A   | D2F-01L-A1   |
|          | General-purpose      | Low force | 25 g       | D2F-FL        | D2F-FL-T        | D2F-FL-D3    | D2F-FL-D       | D2F-FL-A    | D2F-FL-A1    |
|          |                      | Standard  | 80 g       | D2F-L         | D2F-L-T         | D2F-L-D3     | D2F-L-D        | D2F-L-A     | D2F-L-A1     |
|          | Microvoltage/current | Low force | 40 g       | D2F-01FL3     | D2F-01FL3-T     | D2F-01FL3-D3 | D2F-01FL3-D    | D2F-01FL3-A | D2F-01FL3-A1 |
|          |                      | Standard  | 80 g       | D2F-01L3      | D2F-01L3-T      | D2F-01L3-D3  | D2F-01L3-D     | D2F-01L3-A  | D2F-01L3-A1  |
|          | General-purpose      | Low force | 40 g       | D2F-FL3       | D2F-FL3-T       | D2F-FL3-D3   | D2F-FL3-D      | D2F-FL3-A   | D2F-FL3-A1   |
|          |                      | Standard  | 80 g       | D2F-L3        | D2F-L3-T        | D2F-L3-D3    | D2F-L3-D       | D2F-L3-A    | D2F-L3-A1    |
|          | Microvoltage/current | Low force | 40 g       | D2F-01FL2     | D2F-01FL2-T     | D2F-01FL2-D3 | D2F-01FL2-D    | D2F-01FL2-A | D2F-01FL2-A1 |
|          |                      | Standard  | 80 g       | D2F-01L2      | D2F-01L2-T      | D2F-01L2-D3  | D2F-01L2-D     | D2F-01L2-A  | D2F-01L2-A1  |
|          | General-purpose      | Low force | 40 g       | D2F-FL2       | D2F-FL2-T       | D2F-FL2-D3   | D2F-FL2-D      | D2F-FL2-A   | D2F-FL2-A1   |
|          |                      | Standard  | 80 g       | D2F-L2        | D2F-L2-T        | D2F-L2-D3    | D2F-L2-D       | D2F-L2-A    | D2F-L2-A1    |

## Model Number Legend

D2F-□ □ □ □  
1 2 3 4

### 1. Ratings

- None: General loads
  - 01: Micro loads (0.1 A at 30 VDC)
- ### 2. Maximum Operating Force
- None: 1.47 N {150 gf}
  - F: 0.74 N {75 gf}

**Note:** These OF values are for the pin plunger models.

### 3. Actuator

- None: Pin plunger
- L: Hinge lever
- L2: Hinge roller lever
- L3: Simulated roller lever

### 4. Terminals

- None: PCB terminals/straight terminals
- T: Self-clinching PCB terminals
- A: Right-angled PCB terminals
- A1: Left-angled PCB terminals
- D3: Solder terminals
- D: Compact solder terminals

# Specifications

## ■ Characteristics

|  |   |
|--|---|
| Operating speed                                  | 1 to 500 mm/second (pin plunger models)   |
| Operating frequency                              | Mechanical: 200 operations per minute max.<br>Electrical: 30 operations per minute max.   |
| Contact resistance                               | General Purpose: 30 mΩ max. (Standard force versions)<br>50 mΩ max. (Low force versions)<br>Microload: 100 mΩ max.  |
| Insulation resistance                            | 100 MΩ min. at 500 VDC  |
| Dielectric strength (See note 2)                 | 600 VAC, 50/60 Hz for 1 minute between terminals of same polarity<br>1,500 VAC, 50/60 Hz for 1 minute between current-carrying metal parts and ground, and between each terminal and non-current-carrying metal parts |
| Vibration resistance (See note 3)                | Malfunction: 10 to 55 Hz, 1.5 mm double amplitude   |
| Shock resistance (See note 3)                    | Destruction: 1,000 m/s <sup>2</sup> (approx. 100G) max.<br>Malfunction: 300 m/s <sup>2</sup> (approx. 30 g min.) max.   |
| Degree of protection                             | IEC IP40  |
| Degree of protection against electric shock      | Class I   |
| Proof tracking index (PTI)                       | 175   |
| Ambient operating temperature                    | -25° to 65°C (at 60% RH) with no icing  |
| Ambient operating Humidity                       | 85% max. (for 5° to 35°C)   |
| Service life (Consult Omron for test conditions) | Mechanical: 1 million operations min. at 60 operations/minute.<br>Electrical: 30,000 operations min. at 30 operations/minute.   |
| Weight   | Approx. 0.5 g (pin plunger models)  |

- Note:** 1. Data shown are of initial value.  
 2. The dielectric strength shown in the table indicates a value for models with a separator.  
 3. For pin plunger models, the values are measured at the free position and total travel position. For the lever models, they are measured at the total travel position.

## ■ Ratings

| Rated Voltage | Resistive load                       |          |                              |          |
|---------------|--------------------------------------|----------|------------------------------|----------|
|               | Microvoltage/current (D2F-01 models) |          | General-purpose (D2F models) |          |
|               | Low force                            | Standard | Low force                    | Standard |
| 125 VAC       | —                                    | —        | 1 A                          | 3 A      |
| 30 VDC        | 0.1 A                                | 0.1 A    | 0.5 A                        | 2 A      |

- Note:** 1. When using an inductive load or motor load, consult OMRON.  
 2. The ratings apply under the following test conditions: Ambient Temperature = 20±2°C, Ambient Humidity = 65±5%, Operating frequency = 30 operations/min.

## ■ Approvals

Contact Omron to obtain standards approvals on specific models.

### UL Recognized, CSA Certified

| Rated voltage | D2F            |           | D2F-01 |
|---------------|----------------|-----------|--------|
|               | Standard Force | Low Force |        |
| 125 VAC       | 3 A            | 1A        | ---    |
| 30 VDC        | 2 A            | 0.5 A     | 0.1 A  |

**Note:** The rated values approved by each of the safety standards (e.g.UL,CSA) may be different from the performance characteristics individually defined in this catalog.

## ■ Contact Specifications

| Item                               | D2F             | D2F-01       |
|------------------------------------|-----------------|--------------|
| Specification                      | Crossbar        |              |
| Material                           | Silver alloy    | Gold alloy   |
| Gap (Standard value)               | 0.25 mm         |              |
| Minimum Applicable Load (See note) | 100 mA at 5 VDC | 1 mA at 5VDC |

**Note:** Minimum applicable loads are indicated by N standard reference values. This value represents the failure rate at a 60% ( $\lambda_{60}$ ) reliability level (JIS C5003).

The equation  $\lambda_{60}=0.5 \times 10^{-6}$ /operations indicates that a failure rate of 1/2,000,000 operations can be expected at a reliability level of 60%.

# Engineering Data

## Mechanical Service Life

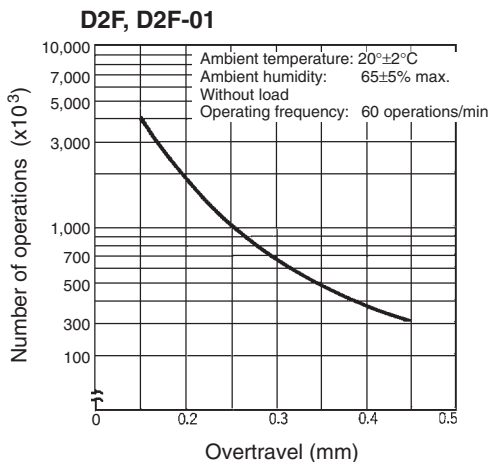

Note: Values are for pin plunger actuator type.

## Electrical Service Life

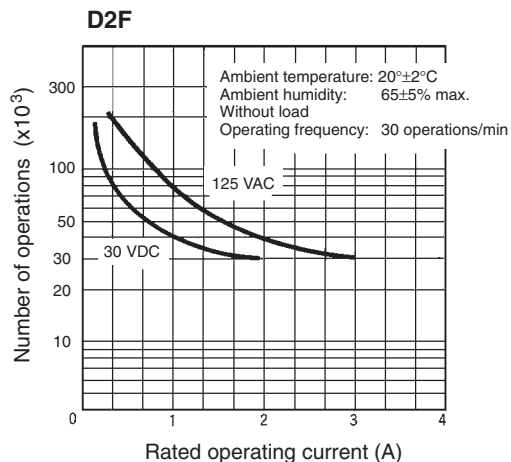

## Mounting

All switches may be panel mounted using M2 mounting screws with plane washers or spring washers to securely mount the switch. Tighten the screws to a torque of 0.08 to 0.1 N-m.

Two, 2-dia. mounting holes

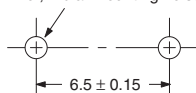

Use of molded components is recommended for mounting purposes

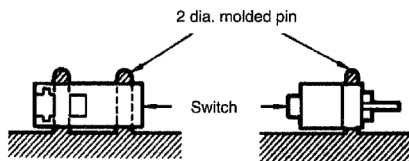

## PCB Layout (reference)

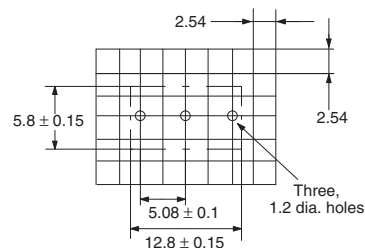

## Structure

### Contact Form (SPDT)

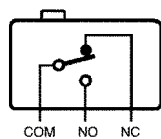

# Dimensions

## ■ Terminals

Note: Unless otherwise specified, all units are in millimeters and a tolerance of  $\pm 0.4$  mm applies to all dimensions

### PCB terminals D2F

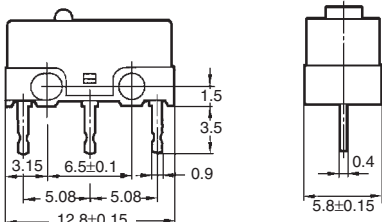

### Self-supporting terminals D2F-T

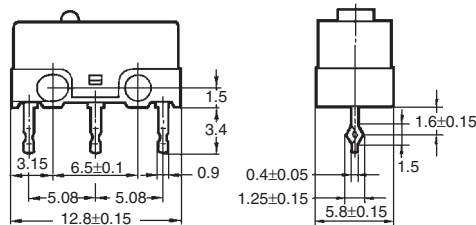

### Solder terminals D2F-D3

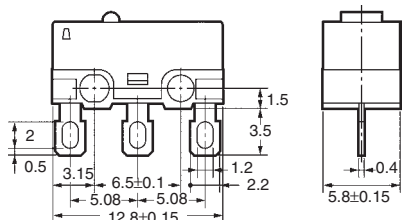

### Compact solder terminals D2F-D

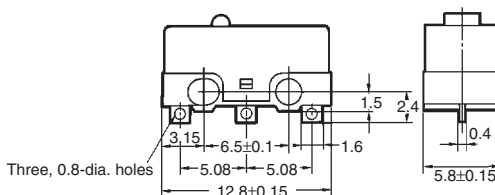

### Right-angle PCB terminals D2F-A

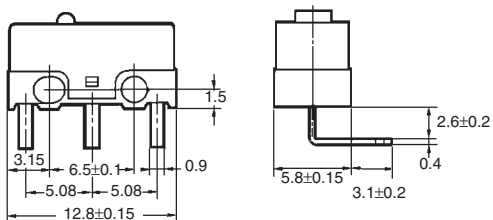

(Top view)

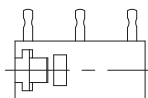

### Left-angle PCB terminals D2F-A1

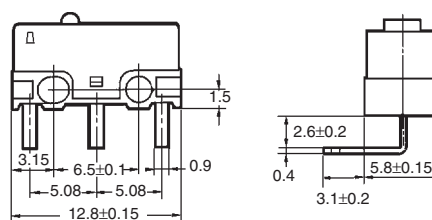

(Top view)

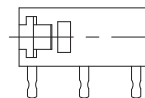

Note: Angled terminal directions are shown below.

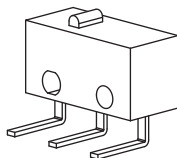

Left-angled terminal

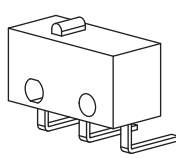

Right-angled terminal

# ■ Dimensions and Operating Characteristics

Note: 1. Unless otherwise specified, all units are in millimeters and a tolerance of  $\pm 0.4$  mm applies to all dimensions

2. Omitted dimensions are the same as pin plunger type.
3. The following illustrations and dimensions are for models with PCB terminals. Refer to "Terminals" for models with self-supporting, solder and right / left angle terminal specifics.
4. The operating characteristics are for operation in the A direction(↓)

## Pin Plunger Models

- D2F-□
- D2F-01-□
- D2F-F-□
- D2F-01F-□

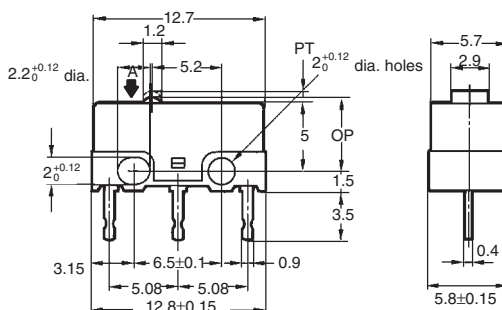
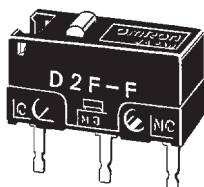

| Characteristics | D2F-□<br>D2F-01-□ | D2F-F-□<br>D2F-01F-□ |
|-----------------|-------------------|----------------------|
| OF max.         | 150 g             | 75 g                 |
| RF min.         | 20 g              | 5 g                  |
| PT max.         | 0.5 mm            | 0.5 mm               |
| OT min.         | 0.25 mm           | 0.25 mm              |
| MD max.         | 0.12 mm           | 0.12 mm              |
| OP              | 5.5 ± 0.3 mm      | 5.5 ± 0.3 mm         |
| FP max.         | —                 | —                    |

## Hinge Lever Models

- D2F-L-□
- D2F-01L-□
- D2F-FL-□
- D2F-01FL-□

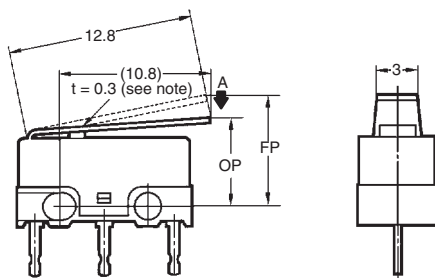
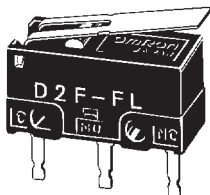

Note: Stainless-steel lever

| Characteristics | D2F-L-□<br>D2F-01L-□ | D2F-FL-□<br>D2F-01FL-□ |
|-----------------|----------------------|------------------------|
| OF max.         | 80 g                 | 25 g                   |
| RF min.         | 5 g                  | 2 g                    |
| PT max.         | —                    | —                      |
| OT min.         | 0.55 mm              | 0.55 mm                |
| MD max.         | 0.5 mm               | 0.5 mm                 |
| OP              | 6.8 ± 1.5 mm         | 6.8 ± 1.5 mm           |
| FP max.         | 10 mm                | 10 mm                  |

## Simulated Roller Lever Models

- D2F-L3-□
- D2F-01L3-□
- D2F-FL3-□
- D2F-01FL3-□

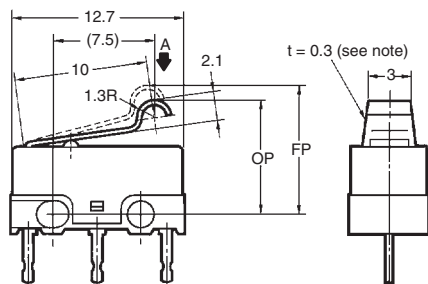
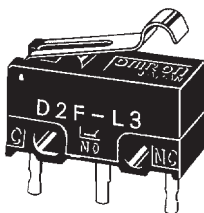

Note: Stainless-steel lever

| Characteristics | D2F-L3-□<br>D2F-01L3-□ | D2F-FL3-□<br>D2F-01FL3-□ |
|-----------------|------------------------|--------------------------|
| OF max.         | 80 g                   | 40 g                     |
| RF min.         | 5 g                    | 2 g                      |
| PT max.         | —                      | —                        |
| OT min.         | 0.5 mm                 | 0.5 mm                   |
| MD max.         | 0.45 mm                | 0.45 mm                  |
| OP              | 8.5 ± 1.2 mm           | 8.5 ± 1.2 mm             |
| FP max.         | 13 mm                  | 13 mm                    |

## Hinge Roller Lever Models

- D2F-L2-□
- D2F-01L2-□
- D2F-FL2-□
- D2F-01FL2-□

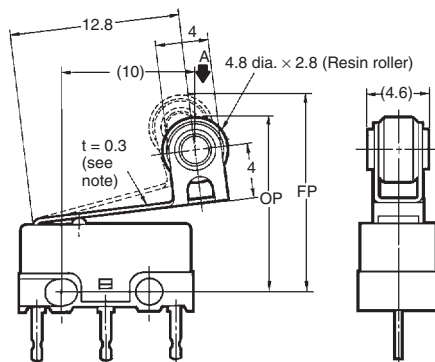
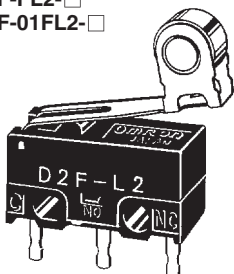

Note: Stainless-steel lever

| Characteristics | D2F-L2-□<br>D2F-01L2-□ | D2F-FL2-□<br>D2F-01FL2-□ |
|-----------------|------------------------|--------------------------|
| OF max.         | 80 g                   | 40 g                     |
| RF min.         | 5 g                    | 2 g                      |
| PT max.         | —                      | —                        |
| OT min.         | 0.55 mm                | 0.55 mm                  |
| MD max.         | 0.5 mm                 | 0.5 mm                   |
| OP              | 13 ± 2.0 mm            | 13 ± 2.0 mm              |
| FP max.         | 16.5 mm                | 16.5 mm                  |

# Precautions

Be sure to read the precautions and information common to all Snap Action and Detection Switches, contained in the Technical User's Guide, "Snap Action Switches, Technical Information" for correct use.

## ■ Correct Use

### Mounting

Turn OFF the power supply before mounting or removing the switch, wiring the switch, or performing maintenance or inspection. Failure to do so may result in electric shock or burning.

Mount the switch onto a flat surface. Mounting on an uneven surface may cause deformation of the switch, resulting in faulty operation or breakage of the housing.

Allow sufficient insulation distance between terminals, terminal traces and between terminals and ground.

### Operating Stroke Setting

Take particular care in setting the operating stroke for the pin plunger models. Make sure that the operating stroke is 70% to 100% of the rated OT distance. Do not operate the actuator exceeding the OT distance, otherwise the service life of the switch maybe decreased.

### Using Microloads

Using a model for ordinary loads to switch microloads may result in faulty operation. Instead, use the models that are designed for microloads and that operate in the following range;

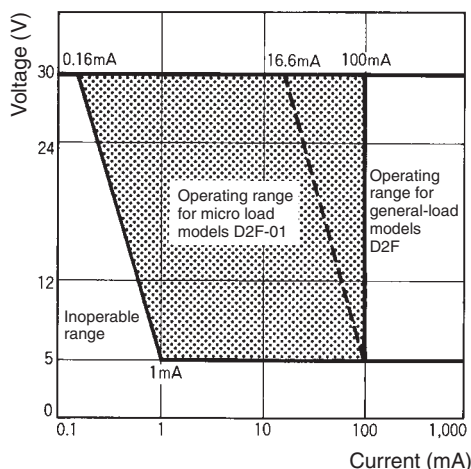

However, even when using microload models within the operating range shown above, if inrush current or inductive voltage spikes occur when the contact is opened or closed, it may increase contact wear and so decrease the service life. Therefore, insert a contact protection circuit where necessary.

## ■ Cautions

### Terminal Connection

When soldering a lead wire to the terminal, first insert the lead wire conductor into the terminal hole and then perform soldering.

Make sure that the capacity of the soldering iron is 30 W maximum and that the temperature of the soldering tip is approximately 300 °C. (350 °C maximum.) Complete soldering within 3 s. After soldering, do not apply external force to the soldered area for about 1 minute.

Using a switch with improper soldering may result in abnormal heating, possibly resulting in a burn.

Applying the soldering iron for more than 3 s or using an iron that is rated for more than 30 W may deteriorate the switch characteristics.

When soldering the lead wire to the PCB terminal, pay careful attention so that the flux and solder liquid level does not exceed the PCB level.

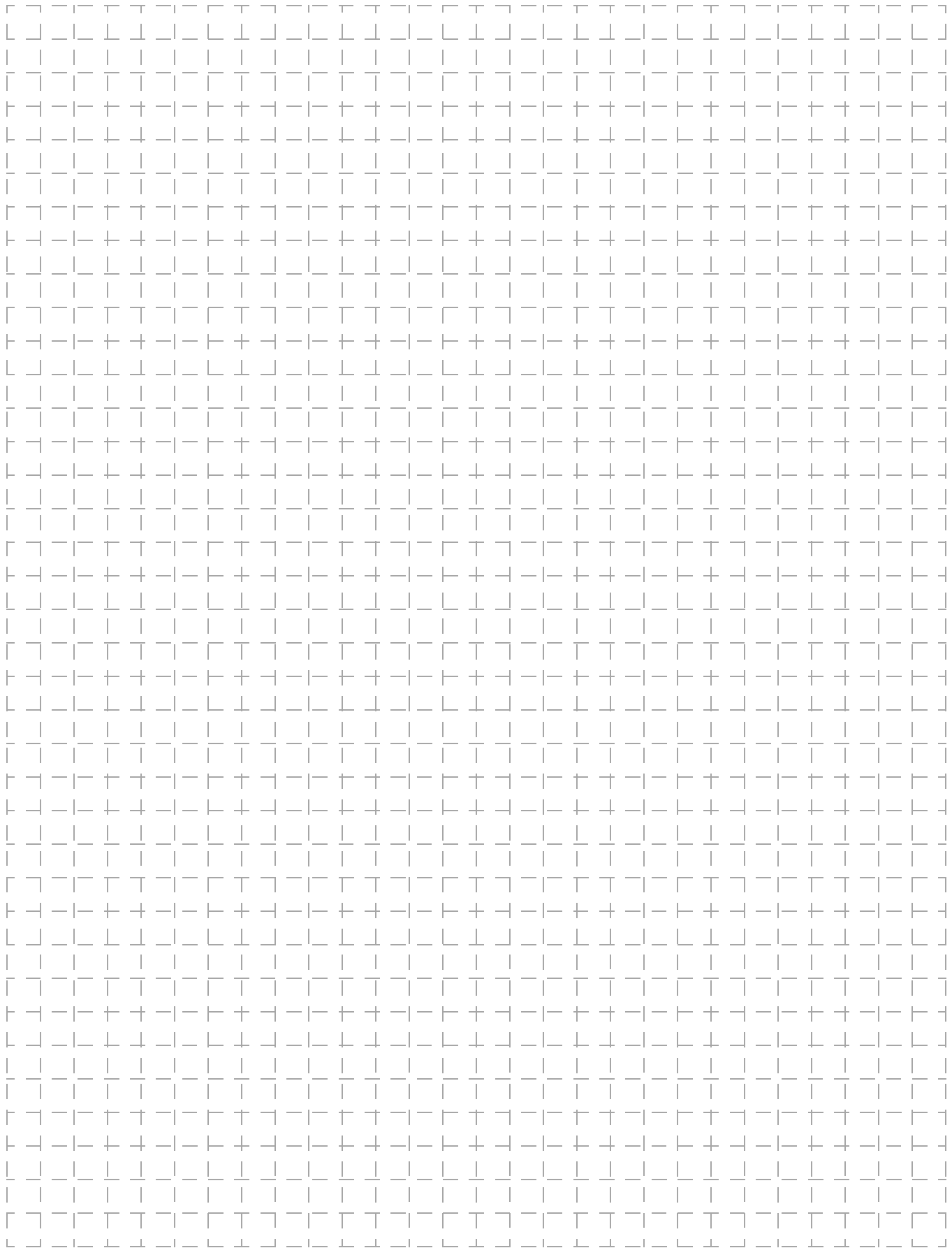

All sales are subject to Omron Electronic Components LLC standard terms and conditions of sale, which can be found at [http://www.components.omron.com/components/web/webfiles.nsf/sales\\_terms.html](http://www.components.omron.com/components/web/webfiles.nsf/sales_terms.html)

**ALL DIMENSIONS SHOWN ARE IN MILLIMETERS.**  
To convert millimeters into inches, multiply by 0.03937. To convert grams into ounces, multiply by 0.03527.

---

**OMRON**<sup>®</sup>

**OMRON ELECTRONIC  
COMPONENTS LLC**

55 E. Commerce Drive, Suite B  
Schaumburg, IL 60173

**847-882-2288**

**OMRON ON-LINE**

Global - <http://www.omron.com>  
USA - <http://www.components.omron.com>

Cat. No. X303-E-1

11/10

Specifications subject to change without notice

Printed in USA





Компания «ЭлектроПласт» предлагает заключение долгосрочных отношений при поставках импортных электронных компонентов на взаимовыгодных условиях!

Наши преимущества:

- Оперативные поставки широкого спектра электронных компонентов отечественного и импортного производства напрямую от производителей и с крупнейших мировых складов;
- Поставка более 17-ти миллионов наименований электронных компонентов;
- Поставка сложных, дефицитных, либо снятых с производства позиций;
- Оперативные сроки поставки под заказ (от 5 рабочих дней);
- Экспресс доставка в любую точку России;
- Техническая поддержка проекта, помощь в подборе аналогов, поставка прототипов;
- Система менеджмента качества сертифицирована по Международному стандарту ISO 9001;
- Лицензия ФСБ на осуществление работ с использованием сведений, составляющих государственную тайну;
- Поставка специализированных компонентов (Xilinx, Altera, Analog Devices, Intersil, Interpoint, Microsemi, Aeroflex, Peregrine, Syfer, Eurofarad, Texas Instrument, Miteq, Cobham, E2V, MA-COM, Hittite, Mini-Circuits, General Dynamics и др.);

Помимо этого, одним из направлений компании «ЭлектроПласт» является направление «Источники питания». Мы предлагаем Вам помощь Конструкторского отдела:

- Подбор оптимального решения, техническое обоснование при выборе компонента;
- Подбор аналогов;
- Консультации по применению компонента;
- Поставка образцов и прототипов;
- Техническая поддержка проекта;
- Защита от снятия компонента с производства.



#### Как с нами связаться

**Телефон:** 8 (812) 309 58 32 (многоканальный)

**Факс:** 8 (812) 320-02-42

**Электронная почта:** [org@eplast1.ru](mailto:org@eplast1.ru)

**Адрес:** 198099, г. Санкт-Петербург, ул. Калинина, дом 2, корпус 4, литера А.