

## NEW SUBMINIATURE SWITCHES WITH HIGH PRECISION

## AV (FS•FS-T) SWITCHES



FS



FS-T

RoHS compliant

### FEATURES

- Consistent quality and high precision through sophisticated automatic fabrication system —O.P.:  $8.4 \pm 0.3$  mm (O.P. of conventional subminiature switches:  $8.4 \pm 0.5$ )
- Flux-resistant construction with integrally molded terminals
- Solder terminal; Self-standing, internationally common pitch, right angle, left angle terminals for PC board; Quick connect .110 terminals for easy mounting
- Insulation guard available for safety mounting

- 2 lever pivot positions available for applications where low operating force is required

### TYPICAL APPLICATIONS

- Communication equipment
- Vending machines
- Security systems
- Data systems
- Medical equipment
- VCR



### CONSTRUCTION (Example: AV3/AVM3 type)

Standard version



Long life version



### CONTACT ARRANGEMENT

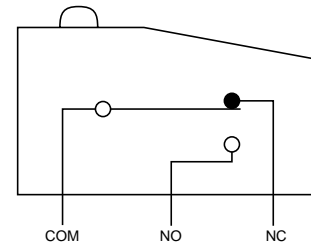

Remark: As for FS-T switches, the terminals are the different shape.

## ORDERING INFORMATION

### 1.FS switches

Ex. AV 3 2 0 2 [ ] [ ] 3

Type of switch	Version	Terminals	Actuators	Operating force by pin plunger, max.	Lever position	Contacts	International standard
AV3(FS) switch	3: Standard	1: Solder terminal with guard 2: Solder terminal without guard 3: Solder terminal with opposite side guard 4: Self-standing PC terminal 5: Internationally common pitch PC terminal 6: Right angle terminal 7: Left angle terminal 8: .110 Quick-connect terminal	0: Pin plunger 1: Short hinge lever 2: Hinge lever 3: Long hinge lever 4: Simulated roller lever 5: Roller lever	0: 0.25 N (Gold-clad contact only) 2: 0.49 N 4: 0.98 N	Nil: Standard [11: forward]	Nil: AgNi alloy 61: Gold-clad triple layer*	3: UL/CSA/VDE/SEMKO

Ex. AV M3 2 0 2 [ ] [ ] 3

Type of switch	Version	Terminals	Actuators	Operating force by pin plunger, max.	Lever position	Contacts	International standard
AV3 (FS long life ver.) switch	M3: Long life	1: Solder terminal with guard 2: Solder terminal without guard 3: Solder terminal with opposite side guard 4: Self-standing PC terminal 5: Internationally common pitch PC terminal 6: Right angle terminal 7: Left angle terminal 8: .110 Quick-connect terminal	0: Pin plunger 1: Short hinge lever 2: Hinge lever 3: Long hinge lever 4: Simulated roller lever 5: Roller lever	5: 1.47 N	Nil: Standard [11: forward]	Nil: AgNi alloy 61: Gold-clad triple layer*	3: UL/CSA/VDE/SEMKO

### 2.FS-T switches

Ex. AV T3 2 0 2 [ ] [ ] 3

Type of switch	Version	Terminals	Actuators	Operating force by pin plunger, max.	Lever position	Contacts	Agency standard
AVT3 (FS-T) switch	T3: Standard	2: Solder terminal 4: PC terminal 8: .110 Quick-connect terminal	0: Pin plunger 1: Short hinge lever 2: Hinge lever 3: Long hinge lever 4: Simulated roller lever 5: Roller lever	0: 0.25 N (Gold-clad contact only) 2: 0.49 N 4: 0.98 N	Nil: Standard [11: forward]	Nil: AgNi alloy (Not applicable to 0.25 N type) 61: Gold-clad triple layer*	3: UL/CSA/VDE/SEMKO

Ex. AV L3 2 0 2 [ ] [ ] 3

Type of switch	Version	Terminals	Actuators	Operating force by pin plunger, max.	Lever position	Contacts	Agency standard
AVL3 (FS-T long life ver.) switch	L3: Long life	2: Solder terminal 4: PC terminal 8: .110 Quick-connect terminal	0: Pin plunger 1: Short hinge lever 2: Hinge lever 3: Long hinge lever 4: Simulated roller lever 5: Roller lever	5: 1.47 N	Nil: Standard [11: forward]	Nil: AgNi alloy (Not applicable to 0.25 N type) 61: Gold-clad triple layer*	3: UL/CSA/VDE/SEMKO

\* Gold-clad triple layer contact

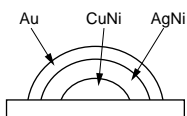

# AV3,AVM3/AVT3,AVL3

## APPLICABLE CURRENT RANGE

Type	Contact	Rating				O.F.			
		1mA	100mA	3A	5A	0.25 N	0.49 N	0.98 N	1.47 N
Standard version	Silver alloy contact						●	●	
	Gold-clad triple layer contact type					●	●	●	
Long life version	Silver alloy contact								●
	Gold-clad triple layer contact type								●

Remark: For high capacity contact rating up to 10.1 A, please refer to PS (AVM3□□□P) switches catalog.

## PRODUCT TYPES

### 1. FS switches (In-line terminal type)

#### Standard type

	Actuator	Operating force, Max.	Part No.					
			Self-standing solder terminal			Self-standing PC terminal	Internationally common pitch PC terminal	
			Without guard	With guard	With opposite side guard			
AgNi alloy contact type	Pin plunger	0.49N	AV32023	AV31023	AV33023	AV34023	AV35023	
		0.98N	AV32043	AV31043	AV33043	AV34043	AV35043	
	Short hinge lever	0.20N	AV32123	AV31123	AV33123	AV34123	AV35123	
		0.39N	AV32143	AV31143	AV33143	AV34143	AV35143	
	Hinge lever	0.16N	AV32223	AV31223	AV33223	AV34223	AV35223	
		0.34N	AV32243	AV31243	AV33243	AV34243	AV35243	
	Long hinge lever	0.12N	AV32323	AV31323	AV33323	AV34323	AV35323	
		0.25N	AV32343	AV31343	AV33343	AV34343	AV35343	
	Simulated roller lever	0.16N	AV32423	AV31423	AV33423	AV34423	AV35423	
		0.34N	AV32443	AV31443	AV33443	AV34443	AV35443	
	Roller lever	0.20N	AV32523	AV31523	AV33523	AV34523	AV35523	
		0.39N	AV32543	AV31543	AV33543	AV34543	AV35543	
	Gold-clad triple layer contact type	Pin plunger	0.25N	AV3200613	AV3100613	AV3300613	AV3400613	AV3500613
			0.49N	AV3202613	AV3102613	AV3302613	AV3402613	AV3502613
0.98N			AV3204613	AV3104613	AV3304613	AV3404613	AV3504613	
Short hinge lever		0.098N	AV3210613	AV3110613	AV3310613	AV3410613	AV3510613	
		0.20N	AV3212613	AV3112613	AV3312613	AV3412613	AV3512613	
		0.39N	AV3214613	AV3114613	AV3314613	AV3414613	AV3514613	
Hinge lever		0.078N	AV3220613	AV3120613	AV3320613	AV3420613	AV3520613	
		0.16N	AV3222613	AV3122613	AV3322613	AV3422613	AV3522613	
		0.34N	AV3224613	AV3124613	AV3324613	AV3424613	AV3524613	
Long hinge lever		0.12N	AV3232613	AV3132613	AV3332613	AV3432613	AV3532613	
		0.25N	AV3234613	AV3134613	AV3334613	AV3434613	AV3534613	
Simulated roller lever		0.16N	AV3242613	AV3142613	AV3342613	AV3442613	AV3542613	
		0.34N	AV3244613	AV3144613	AV3344613	AV3444613	AV3544613	
Roller lever		0.20N	AV3252613	AV3152613	AV3352613	AV3452613	AV3552613	
		0.39N	AV3254613	AV3154613	AV3354613	AV3454613	AV3554613	

	Actuator	Operating force, Max.	Part No.			
			Right angle terminal	Left angle terminal	.110 Quick-connect	
AgNi alloy contact type	Pin plunger	0.49N	AV36023	AV37023	AV38023	
		0.98N	AV36043	AV37043	AV38043	
	Short hinge lever	0.20N	AV36123	AV37123	AV38123	
		0.39N	AV36143	AV37143	AV38143	
	Hinge lever	0.16N	AV36223	AV37223	AV38223	
		0.34N	AV36243	AV37243	AV38243	
	Long hinge lever	0.12N	AV36323	AV37323	AV38323	
		0.25N	AV36343	AV37343	AV38343	
	Simulated roller lever	0.16N	AV36423	AV37423	AV38423	
		0.34N	AV36443	AV37443	AV38443	
	Roller lever	0.20N	AV36523	AV37523	AV38523	
		0.39N	AV36543	AV37543	AV38543	
	Gold-clad triple layer contact type	Pin plunger	0.25N	AV3600613	AV3700613	AV3800613
			0.49N	AV3602613	AV3702613	AV3802613
0.98N			AV3604613	AV3704613	AV3804613	
Short hinge lever		0.098N	AV3610613	AV3710613	AV3810613	
		0.20N	AV3612613	AV3712613	AV3812613	
		0.39N	AV3614613	AV3714613	AV3814613	
Hinge lever		0.078N	AV3620613	AV3720613	AV3820613	
		0.16N	AV3622613	AV3722613	AV3822613	
		0.34N	AV3624613	AV3724613	AV3824613	
Long hinge lever		0.12N	AV3632613	AV3732613	AV3832613	
		0.25N	AV3634613	AV3734613	AV3834613	
Simulated roller lever		0.16N	AV3642613	AV3742613	AV3842613	
		0.34N	AV3644613	AV3744613	AV3844613	
Roller lever		0.20N	AV3652613	AV3752613	AV3852613	
	0.39N	AV3654613	AV3754613	AV3854613		

Remark: When ordering, please refer to "Remarks" of ordering information.

# AV3,AVM3/AVT3,AVL3

## 2. FS-T switches (Cross-line terminal type)

Standard type

	Actuator	Operating force, Max.	Part No.			
			Solder terminal without guard	PC terminal	.110 Quick-connect terminal	
AgNi alloy contact type	Pin plunger	0.49N	AVT32023	AVT34023	AVT38023	
		0.98N	AVT32043	AVT34043	AVT38043	
	Short hinge lever	0.20N	AVT32123	AVT34123	AVT38123	
		0.39N	AVT32143	AVT34143	AVT38143	
	Hinge lever	0.16N	AVT32223	AVT34223	AVT38223	
		0.34N	AVT32243	AVT34243	AVT38243	
	Long hinge lever	0.12N	AVT32323	AVT34323	AVT38323	
		0.25N	AVT32343	AVT34343	AVT38343	
	Simulated roller lever	0.16N	AVT32423	AVT34423	AVT38423	
		0.34N	AVT32443	AVT34443	AVT38443	
	Roller lever	0.20N	AVT32523	AVT34523	AVT38523	
		0.39N	AVT32543	AVT34543	AVT38543	
	Gold-clad triple layer contact type	Pin plunger	0.25N	AVT3200613	AVT3400613	AVT3800613
			0.49N	AVT3202613	AVT3402613	AVT3802613
0.98N			AVT3204613	AVT3404613	AVT3804613	
Short hinge lever		0.098N	AVT3210613	AVT3410613	AVT3810613	
		0.20N	AVT3212613	AVT3412613	AVT3812613	
		0.39N	AVT3214613	AVT3414613	AVT3814613	
Hinge lever		0.078N	AVT3220613	AVT3420613	AVT3820613	
		0.16N	AVT3222613	AVT3422613	AVT3822613	
		0.34N	AVT3224613	AVT3424613	AVT3824613	
Long hinge lever		0.12N	AVT3232613	AVT3432613	AVT3832613	
		0.25N	AVT3234613	AVT3434613	AVT3834613	
Simulated roller lever		0.16N	AVT3242613	AVT3442613	AVT3842613	
		0.34N	AVT3244613	AVT3444613	AVT3844613	
Roller lever		0.20N	AVT3252613	AVT3452613	AVT3852613	
		0.39N	AVT3254613	AVT3454613	AVT3854613	

**3. FS switches (In-line terminal type)**

Long life version

	Actuator	Operating force, Max.	Part No.				
			Self-standing solder terminal			Self-standing PC terminal	Internationally common pitch PC terminal
			Without guard	With guard	With opposite side guard		
AgNi alloy contact type	Pin plunger	1.47N	AVM32053	AVM31053	AVM33053	AVM34053	AVM35053
	Short hinge lever	0.59N	AVM32153	AVM31153	AVM33153	AVM34153	AVM35153
	Hinge lever	0.54N	AVM32253	AVM31253	AVM33253	AVM34253	AVM35253
	Long hinge lever	0.44N	AVM32353	AVM31353	AVM33353	AVM34353	AVM35353
	Simulated roller lever	0.54N	AVM32453	AVM31453	AVM33453	AVM34453	AVM35453
	Roller lever	0.59N	AVM32553	AVM31553	AVM33553	AVM34553	AVM35553
Gold-clad triple layer contact type	Pin plunger	1.47N	AVM3205613	AVM3105613	AVM3305613	AVM3405613	AVM3505613
	Short hinge lever	0.59N	AVM3215613	AVM3115613	AVM3315613	AVM3415613	AVM3515613
	Hinge lever	0.54N	AVM3225613	AVM3125613	AVM3325613	AVM3425613	AVM3525613
	Long hinge lever	0.44N	AVM3235613	AVM3135613	AVM3335613	AVM3435613	AVM3535613
	Simulated roller lever	0.54N	AVM3245613	AVM3145613	AVM3345613	AVM3445613	AVM3545613
	Roller lever	0.59N	AVM3255613	AVM3155613	AVM3355613	AVM3455613	AVM3555613

	Actuator	Operating force, Max.	Part No.		
			Right angle terminal	Left angle terminal	.110 Quick-connect
			Without guard	With guard	With opposite side guard
AgNi alloy contact type	Pin plunger	1.47N	AVM36053	AVM37053	AVM38053
	Short hinge lever	0.59N	AVM36153	AVM37153	AVM38153
	Hinge lever	0.54N	AVM36253	AVM37253	AVM38253
	Long hinge lever	0.44N	AVM36353	AVM37353	AVM38353
	Simulated roller lever	0.54N	AVM36453	AVM37453	AVM38453
	Roller lever	0.59N	AVM36553	AVM37553	AVM38553
Gold-clad triple layer contact type	Pin plunger	1.47N	AVM3605613	AVM3705613	AVM3805613
	Short hinge lever	0.59N	AVM3615613	AVM3715613	AVM3815613
	Hinge lever	0.54N	AVM3625613	AVM3725613	AVM3825613
	Long hinge lever	0.44N	AVM3635613	AVM3735613	AVM3835613
	Simulated roller lever	0.54N	AVM3645613	AVM3745613	AVM3845613
	Roller lever	0.59N	AVM3655613	AVM3755613	AVM3855613

Remark: When ordering, please refer to "Remarks" of ordering information.

**4. FS-T switches (Cross-line terminal type)**

Long life version

	Actuator	Operating force, Max.	Part No.		
			Solder terminal Without guard	PC terminal	.110 Quick-connect terminal
			AgNi alloy contact type	Pin plunger	1.47N
Short hinge lever	0.59N	AVL32153		AVL34153	AVL38153
Hinge lever	0.54N	AVL32253		AVL34253	AVL38253
Long hinge lever	0.44N	AVL32353		AVL34353	AVL38353
Simulated roller lever	0.54N	AVL32453		AVL34453	AVL38453
Roller lever	0.59N	AVL32553		AVL34553	AVL38553
Gold-clad triple layer contact type	Pin plunger	1.47N	AVL3205613	AVL3405613	AVL3805613
	Short hinge lever	0.59N	AVL3215613	AVL3415613	AVL3815613
	Hinge lever	0.54N	AVL3225613	AVL3425613	AVL3825613
	Long hinge lever	0.44N	AVL3235613	AVL3435613	AVL3835613
	Simulated roller lever	0.54N	AVL3245613	AVL3445613	AVL3845613
	Roller lever	0.59N	AVL3255613	AVL3455613	AVL3855613

Remark: When ordering, please refer to "Remarks" of ordering information.

# AV3,AVM3/AVT3,AVL3

## SPECIFICATIONS

### 1.Contact rating

Voltage	Standard version			Long life version		
	AgNi alloy contact type		Gold-clad contact type	AgNi alloy contact type		Gold-clad contact type
	Resistive load ( $\cos\phi \approx 1$ )	Inductive load ( $\cos\phi \approx 0.6-0.7$ )	Triple layer	Resistive load ( $\cos\phi \approx 1$ )	Inductive load ( $\cos\phi \approx 0.6-0.7$ )	Triple layer
125V AC	3A	2A	0.1A	5A	3A	0.1A
250V AC	3A	2A	0.1A	5A	3A	0.1A
30V DC	3A	2A	0.1A	5A	3A	0.1A
125V DC	0.4A	0.05A	—	0.4A	0.05A	—

Remark: Time constant shall be less than 7 msec. for DC inductive loads.

### 2.Characteristics

	Standard version		Long life version	
	AgNi alloy contact type	Gold-clad contact type	AgNi alloy contact type	Gold-clad contact type
Electrical life at rated load (O.T.max.)	$5 \times 10^4$ at 20 cpm	$2 \times 10^5$ at 20 cpm	$5 \times 10^4$ at 20 cpm	$2 \times 10^5$ at 20 cpm
Mechanical life	$5 \times 10^5$ at 60 cpm (O.T.max.)		$3 \times 10^7$ (O.T.: Specified value) $10^7$ (O.T.max.) at 60 cpm	
Insulation resistance	Min.100M $\Omega$ at 500V DC			
Dielectric strength	1,000 Vrms			
Between non-continuous terminals	1,500 Vrms			
Between each terminal and other exposed metal parts	1,500 Vrms			
Between each terminal and ground	1,500 Vrms			
Vibration resistance (Pin plunger type)	10 to 55 Hz at single amplitude of 1.5mm (Contact opening: max.1 msec.)			
Shock resistance (Pin plunger type) (Contact opening: less than 1 msec.)	294 m/s <sup>2</sup> min. (O.F. 0.98 N) 147 m/s <sup>2</sup> min. (O.F. 0.49 N)	294 m/s <sup>2</sup> min. (O.F. 0.98 N) 147 m/s <sup>2</sup> min. (O.F. 0.49 N) 49 m/s <sup>2</sup> min. (O.F. 0.25 N)	294 m/s <sup>2</sup> min.	
Contact resistance (Initial)	50 m $\Omega$ max. (by voltage drop 1 A 6 to 8V DC)	100 m $\Omega$ max. (by voltage drop 0.1 A 6 to 8V DC)	Au: 50 m $\Omega$ max. (by voltage drop 0.1 A 6 to 8V DC) Ag: 50 m $\Omega$ max. (by voltage drop 1 A 6 to 8V DC)	
Allowable operating speed	0.1 to 1,000 mm/sec.			
Max.operating cycle rate	300 cpm			
Ambient temperature	-25°C to +85°C (no freezing below 0°C)			
Unit weight	Approx.2g			

### 3.Operating characteristics

#### 1) Pin plunger

4th digit number of Part No.	O.F.max.	R.F.min.	P.T.max.	M.D.max.	O.T.max.	O.P.
0	0.25N	0.020N	0.6mm	0.1mm	0.4mm	Distance from mounting holes: 8.4±0.3mm Distance from stand-off: FS 11.8±0.4mm FS-T 11.7±0.4mm
2	0.49N	0.074N				
4	0.98N	0.15N				
5	1.47N	0.20N				

#### 2) Short hinge lever

4th digit number of Part No.	O.F.max.	R.F.min.	P.T.max.	M.D.max.	O.T.max.	O.P.
0	0.098N	0.004N	2.5mm	0.5mm	0.8mm	Distance from mounting holes: 8.8±0.8mm Distance from stand-off: FS 12.2±0.9mm FS-T 12.1±0.9mm
2	0.20N	0.017N				
4	0.39N	0.034N				
5	0.59N	0.039N				

### 3) Hinge lever

4th digit number of Part No.	O.F.max.	R.F.min.	P.T.max.	M.D.max.	O.T.max.	O.P.
0	0.078N	0.003N	2.8mm	0.8mm	1.2mm	Distance from mounting holes: 8.8±0.8mm Distance from stand-off: FS 12.2±0.9mm FS-T 12.1±0.9mm
2	0.16N	0.015N				
4	0.34N	0.029N				
5	0.54N	0.034N				

### 4) Long hinge lever

4th digit number of Part No.	O.F.max.	R.F.min.	P.T.max.	M.D.max.	O.T.max.	O.P.
0	—	—	3.5mm	1.0mm	1.6mm	Distance from mounting holes: 8.8±1.2mm Distance from stand-off: FS 12.2±1.3mm FS-T 12.1±1.3mm
2	0.12N	0.012N				
4	0.25N	0.025N				
5	0.44N	0.029N				

### 5) Simulated roller lever

4th digit number of Part No.	O.F.max.	R.F.min.	P.T.max.	M.D.max.	O.T.max.	O.P.
0	—	—	2.8mm	0.8mm	1.2mm	Distance from mounting holes: 11.65±0.8mm Distance from stand-off: FS 15.05±0.9mm FS-T 14.95±0.9mm
2	0.16N	0.015N				
4	0.34N	0.029N				
5	0.54N	0.034N				

### 6) Roller lever

4th digit number of Part No.	O.F.max.	R.F.min.	P.T.max.	M.D.max.	O.T.max.	O.P.
0	—	—	2.5mm	0.5mm	0.8mm	Distance from mounting holes: 14.5±0.8mm Distance from stand-off: FS 17.9±0.9mm FS-T 17.8±0.9mm
2	0.20N	0.017N				
4	0.39N	0.034N				
5	0.59N	0.039N				

## DIMENSIONS

The CAD data of the products with a **CAD Data** mark can be downloaded from: <http://industrial.panasonic.com/ac/e>

### 1. FS switches (In-line terminal type)

mm General tolerance: ±0.25

#### 1-(1) Solder terminal (without guard)

**CAD Data**



Dimensions other than drawn above is same as self-standing PC board terminal.



# AV3,AVM3/AVT3,AVL3

1-(2) Solder terminal (with guard)

mm General tolerance:  $\pm 0.25$

**CAD Data**



Dimensions other than drawn above is same as guardless type.

1-(3) Solder terminal (with opposite side guard)

**CAD Data**



Dimensions other than drawn above is same as guardless type.

1-(4) Self-standing PC terminal

Pin plunger

**CAD Data**



PC board pattern

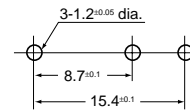

Pretravel, Max. mm		0.6
Movement differential, Max. mm		0.1
Overtravel, Min. mm		0.4
Operating position	Distance from mounting hole, mm	8.4±0.3
	Distance from standoff, mm	11.8±0.4

Short hinge lever

**CAD Data**



Pretravel, Max. mm		2.5
Movement differential, Max. mm		0.5
Overtravel, Min. mm		0.8
Operating position	Distance from mounting hole, mm	8.8±0.8
	Distance from standoff, mm	12.2±0.9

Hinge lever

**CAD Data**



Pretravel, Max. mm		2.8
Movement differential, Max. mm		0.8
Overtravel, Min. mm		1.2
Operating position	Distance from mounting hole, mm	8.8±0.8
	Distance from standoff, mm	12.2±0.9

## Long hinge lever

mm General tolerance: ±0.25

### CAD Data



Pretravel, Max. mm	3.5	
Movement differential, Max. mm	1.0	
Overtravel, Min. mm	1.6	
Operating position	Distance from mounting hole, mm	8.8±1.2
	Distance from standoff, mm	12.2±1.3

## Simulated roller lever

### CAD Data



Pretravel, Max. mm	2.8	
Movement differential, Max. mm	0.8	
Overtravel, Min. mm	1.2	
Operating position	Distance from mounting hole, mm	11.65±0.8
	Distance from standoff, mm	15.05±0.9

## Roller lever

### CAD Data



Pretravel, Max. mm	2.5	
Movement differential, Max. mm	0.5	
Overtravel, Min. mm	0.8	
Operating position	Distance from mounting hole, mm	14.5±0.8
	Distance from standoff, mm	17.9±0.9

## 1-(5) Internationally common pitch PC terminal

### CAD Data



### PC board pattern

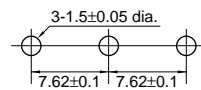

## 1-(6) Right angle terminal

### CAD Data

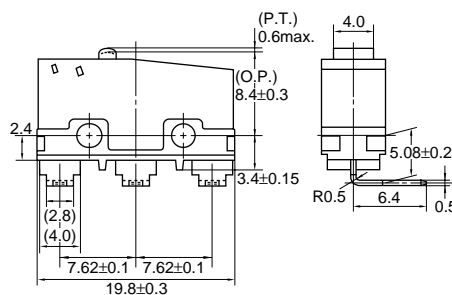

### PC board pattern

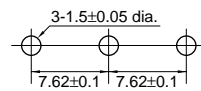

# AV3,AVM3/AVT3,AVL3

1-(7) Left angle terminal

mm General tolerance:  $\pm 0.25$

**CAD Data**

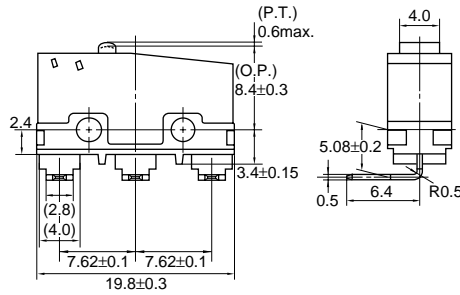

PC board pattern



1-(8) .110 Quick-connect terminal

**CAD Data**



Dimensions other than drawn above is same as self-standing PC board terminal.

## 2.FS-T switches (Cross-line terminal type)

2-(1) PC board terminal

Pin plunger

**CAD Data**

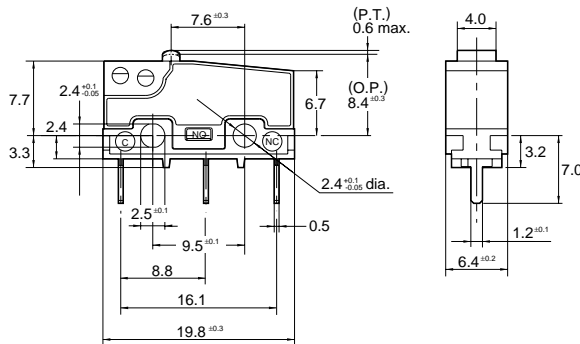

PC board pattern



Pretravel, Max. mm	0.6	
Movement differential, Max. mm	0.1	
Overtravel, Min. mm	0.4	
Operating position	Distance from mounting hole, mm	8.4±0.3
	Distance from standoff, mm	11.7±0.4

Short hinge lever

**CAD Data**



Pretravel, Max. mm	2.5	
Movement differential, Max. mm	0.5	
Overtravel, Min. mm	0.8	
Operating position	Distance from mounting hole, mm	8.8±0.8
	Distance from standoff, mm	12.1±0.9

# AV3,AVM3/AVT3,AVL3

mm General tolerance: ±0.25

## Hinge lever

**CAD Data**



Pretravel, Max. mm		2.8
Movement differential, Max. mm		0.8
Overtravel, Min. mm		1.2
Operating position	Distance from mounting hole, mm	8.8±0.8
	Distance from standoff, mm	12.1±0.9

## Long hinge lever

**CAD Data**



Pretravel, Max. mm		3.5
Movement differential, Max. mm		1.0
Overtravel, Min. mm		1.6
Operating position	Distance from mounting hole, mm	8.8±1.2
	Distance from standoff, mm	12.1±1.3

## Simulated roller lever

**CAD Data**

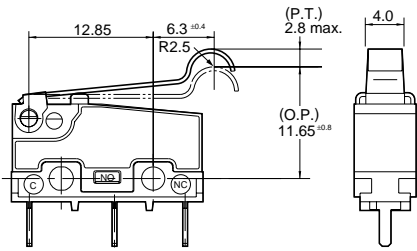

Pretravel, Max. mm		2.8
Movement differential, Max. mm		0.8
Overtravel, Min. mm		1.2
Operating position	Distance from mounting hole, mm	11.65±0.8
	Distance from standoff, mm	14.95±0.9

## Roller lever

**CAD Data**



Pretravel, Max. mm		2.5
Movement differential, Max. mm		0.5
Overtravel, Min. mm		0.8
Operating position	Distance from mounting hole, mm	14.5±0.8
	Distance from standoff, mm	17.8±0.9

## 2-(2) Solder terminal

**CAD Data**



As for the dimensions of lever types, dimensions other than terminals are same as self-standing solder terminal.

# AV3,AVM3/AVT3,AVL3

2-(3) .110 Quick-connect terminal

mm General tolerance:  $\pm 0.25$

## CAD Data



As for the dimensions of lever types, dimensions other than terminals are same as self-standing solder terminal.

## NOTES

### 1.Regarding fastening of switch body

In fastening the switch body, use flat filister head M2.3 screws, with tightening torque of not more than 0.29N·m. To prevent loosening of the screws, it is recommended that spring washers be used with the screws and adhesive be applied to lock the screws.

After mounting the switch and making wiring connections, the insulation distance between ground and each terminal should be confirmed as sufficient.

The positioning of the switch should be such that the pushbutton or actuator for the switch should not directly apply force to the operating section in the free condition. For a pushbutton, the force from the pushbutton should be applied in a perpendicular direction.

In setting the movement after operation, the over-travel should be set not less than 70% as a standard. Setting the movement at less than 70% of O.T. may cause troubles such as mis-contact and welding due to small contact force of the switch.

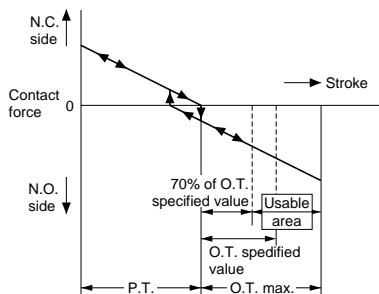

### 2.Soldering operation

Manual soldering should be accomplished within 3 seconds with max. 350°C iron.

Care should be taken not to apply force to the terminals during soldering. Terminal portions must not be moved in min.1 minute after soldering. Also no tensile strength of lead wires should be applied to terminals.

### 3.Regarding connector connections (.110 quick connect terminals)

For making connections, a dedicated receptacle for .110 quick connect terminals should be used, and the terminals should be inserted parallel to the receptacle. Consideration should be given to mounting so that no tensile load is applied to the lead wires.

### 4.In making the switch selection

Consideration should be given to provide for no interference up to +20% variation of the standard characteristics values.

### 5.Environment

Locations where corrosive gases having a bad influence on contacts are present, and locations where there is an excessive amount of siliceous or other abrasive dust should be avoided.

### 6.Cautions regarding use

This subminiature switch has been designed as a dedicated switch for AC use, but it can be used for low capacity DC circuits.

Please select gold-clad contact types when loads are in the low-level area of 1mA up to 100mA and 5V up to 30V.



For switching of inductive loads (relays, solenoids, buzzers, etc.), in order to prevent damage to contacts due to the occurrence of arcing, an arc absorbing circuit should be applied

### 7.Quality check under Actual Loading Condition

To assure reliability, check the switch under actual loading conditions. Avoid any situation that may adversely affect switching performance.

**8.When using lever type switch, care should be taken not to apply undue force on the body from the opposite side or side ways to its operating direction.**



Компания «ЭлектроПласт» предлагает заключение долгосрочных отношений при поставках импортных электронных компонентов на взаимовыгодных условиях!

Наши преимущества:

- Оперативные поставки широкого спектра электронных компонентов отечественного и импортного производства напрямую от производителей и с крупнейших мировых складов;
- Поставка более 17-ти миллионов наименований электронных компонентов;
- Поставка сложных, дефицитных, либо снятых с производства позиций;
- Оперативные сроки поставки под заказ (от 5 рабочих дней);
- Экспресс доставка в любую точку России;
- Техническая поддержка проекта, помощь в подборе аналогов, поставка прототипов;
- Система менеджмента качества сертифицирована по Международному стандарту ISO 9001;
- Лицензия ФСБ на осуществление работ с использованием сведений, составляющих государственную тайну;
- Поставка специализированных компонентов (Xilinx, Altera, Analog Devices, Intersil, Interpoint, Microsemi, Aeroflex, Peregrine, Syfer, Eurofarad, Texas Instrument, Miteq, Cobham, E2V, MA-COM, Hittite, Mini-Circuits, General Dynamics и др.);

Помимо этого, одним из направлений компании «ЭлектроПласт» является направление «Источники питания». Мы предлагаем Вам помощь Конструкторского отдела:

- Подбор оптимального решения, техническое обоснование при выборе компонента;
- Подбор аналогов;
- Консультации по применению компонента;
- Поставка образцов и прототипов;
- Техническая поддержка проекта;
- Защита от снятия компонента с производства.



#### Как с нами связаться

**Телефон:** 8 (812) 309 58 32 (многоканальный)

**Факс:** 8 (812) 320-02-42

**Электронная почта:** [org@eplast1.ru](mailto:org@eplast1.ru)

**Адрес:** 198099, г. Санкт-Петербург, ул. Калинина, дом 2, корпус 4, литера А.