

Surface Mount Power Resistor Thick Film Technology

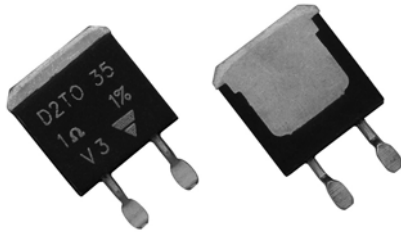

FEATURES

- AEC-Q200 qualified
- 35 W at 25 °C case temperature
- Surface mounted resistor - TO-263 (D²PAK) style package
- Wide resistance range from 0.01 W to 550 kW
- Non inductive
- Resistor isolated from metal tab
- Solder reflow secure at 270 °C/10 s
- Material categorization: For definitions of compliance please see www.vishay.com/doc?99912

**RoHS
COMPLIANT**

DIMENSIONS in millimeters

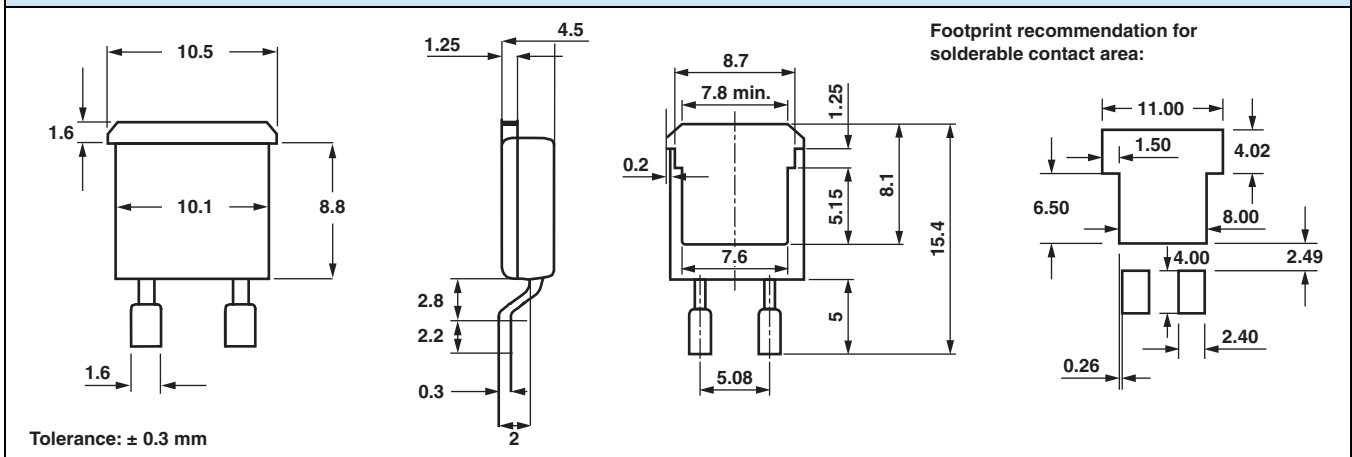

Notes

- For the assembly on board, we recommend the lead (Pb)-free thermal profile as per J-STD-020C
- Power dissipation is 3.3 W at an ambient temperature of 25 °C when mounted on a double sided copper board using FR4 standard, 70 µm of copper, 39 mm x 30 mm x 1.6 mm

STANDARD ELECTRICAL SPECIFICATIONS

MODEL	SIZE	RESISTANCE RANGE Ω	RATED POWER $P_{25\text{ °C}}$ W	LIMITING ELEMENT VOLTAGE U_L V	TOLERANCE ± %	TEMPERATURE COEFFICIENT ± ppm/°C	CRITICAL RESISTANCE Ω
D2TO35	TO-263	0.01 to 550K	35	500	1, 2, 5, 10	150, 250, 700, 1100	7.14K

MECHANICAL SPECIFICATIONS

Mechanical Protection	Molded
Resistive Element	Thick film
Substrate	Alumina
Connections	Tinned copper
Weight	2.2 g max.

ENVIRONMENTAL SPECIFICATIONS

Temperature Range	- 55 °C to 175 °C
Flammability	IEC 60695-11-5 2 applications 30 s separated by 60 s

TECHNICAL SPECIFICATIONS

Power Rating and Thermal Resistance of the Component	350 W at 25 °C (case temperature) $R_{TH(j-c)}$: 4.28 °C/W
Temperature Coefficient Standard	See Special Feature table ± 150 ppm/°C
Dielectric Strength IEC 60115-1	2000 V_{RMS} - 1 min - 10 mA max. (between terminals and board)
Insulation Resistance	≥ 10 ⁶ MΩ
Inductance	≤ 0.1 µH

DIMENSIONS

Standard Package	TO-263 style (D ² PAK)
------------------	--------------------------------------



SPECIAL FEATURES				
Resistance Values	≥ 0.010	≥ 0.045	≥ 0.1	≥ 0.5
Tolerances	± 1 % at ± 10 %			
Requirement Temperature Coefficient (TCR) (- 55 °C + 150 °C) IEC 60115-1	± 1100 ppm/°C	± 700 ppm/°C	± 250 ppm/°C	± 150 ppm/°C

PERFORMANCE		
TESTS	CONDITIONS	REQUIREMENTS
Momentary Overload	IEC 60115-1 §4.13 1.7 Pr 5 s for $R < 2 \Omega$ 1.4 Pr 5 s for $R \geq 2 \Omega$ US < 1.5 UL	± (0.25 % + 0.005 Ω)
Load Life	IEC 60115-1 1000 h, 90/30 Pr at + 25 °C	± (1 % + 0.005 Ω)
High Temperature Exposure	AEC-Q200 REV C conditions: MIL-STD-202 method 108 1000 h, + 175 °C, unpowered	± (0.25 % + 0.005 Ω)
Temperature Cycling	Pre-conditioning 3 reflows according JESTD020D IEC 60068-2-14 test Na 1000 cycles, - 55 °C, + 175 °C Dwell time - 15 min	± (0.5 % + 0.005 Ω)
Moisture Resistance	AEC-Q200 REV C conditions: MIL-STD-202 method 106 10 cycles, 24 h, unpowered	± (0.5 % + 0.005 Ω)
Biased Humidity	AEC-Q200 REV C conditions: MIL-STD-202 method 103 1000 h, 85 °C, 85% RH	± (1 % + 0.005 Ω)
Operational Life	AEC-Q200 REV C conditions: Pre-conditioning 3 reflows according JESTD020D MIL-STD-202 method 108 1000 h, 90/30, powered, + 125 °C	± (1 % + 0.005 Ω)
ESD Human Body Model	AEC-Q200 REV C conditions: AEC-Q200-002 25 kV _{AD}	± (0.5 % + 0.005 Ω)
Vibration	AEC-Q200 REV C conditions: MIL-STD-202 method 204 5 g's for 20 min, 12 cycles test from 10 Hz to 2000 Hz	± (0.5 % + 0.005 Ω)
Mechanical Shock	AEC-Q200 REV C conditions: MIL-STD-202 method 213 100 g's, 6 ms, 3.75 m/s 3 shocks/direction	± (0.5 % + 0.005 Ω)
Board Flex	AEC-Q200 REV C conditions: AEC-Q200-005 bending 2 mm, 60 s	± (0.25 % + 0.01 Ω)
Terminal Strength	AEC-Q200 REV C conditions: AEC-Q200-006 1.8 kgf, 60 s	± (0.25 % + 0.01 Ω)

ASSEMBLY SPECIFICATIONS		
For the assembly on board, we recommend the lead (Pb)-free thermal profile as per J-STD-020C		
TESTS	CONDITIONS	REQUIREMENTS
Resistance to Soldering Heat	IEC 60115-1 IEC 60068-2-58 Solder bath method: 270 °C/10 s	± (0.5 % + 0.005 Ω)
Moisture Sensitivity Level (MSL)	IPC/JEDEC J-STD-020C 85 °C/85 % RH/168 h	Level: 1 + pass requirements of TCR overload and dielectric strength after MSL



CHOICE OF THE BOARD

The user must choose the board according to the working conditions of the component (power, room temperature). Maximum working temperature must not exceed 175 °C. The dissipated power is simply calculated by the following ratio:

$$P = \frac{\Delta T}{[R_{TH(j-c)}] + [R_{TH(c-h)}] + [R_{TH(h-a)}]} \quad (1)$$

P: Expressed in W

ΔT: Difference between maximum working temperature and room temperature or fluid cooling temperature

R_{TH(j-c)}: Thermal resistance value measured between resistive layer and outer side of the resistor. It is the thermal resistance of the component: 4.28 °C/W.

R_{TH(c-h)}: Thermal resistance value measure 4.28 °C/W. Outer side of the resistor and upper side of the board. This is the thermal resistance of the solder layer.

R_{TH(h-a)}: Thermal resistance of the board.

Example:

R_{TH(c-h)} + R_{TH(h-a)} for D2TO35 power rating 3.5 W at ambient temperature + 25 °C.

Thermal resistance R_{TH(j-c)}: 4.28 °C/W

Considering equation (1) we have:

$$\Delta T = 175 \text{ °C} - 25 \text{ °C} = 150 \text{ °C}$$

$$R_{TH(j-c)} + R_{TH(c-h)} + R_{TH(h-a)} = \Delta T / P = 150 / 3.5 = 42.8 \text{ °C/W}$$

$$R_{TH(c-h)} + R_{TH(h-a)} = 42.8 \text{ °C/W} - 4.28 \text{ °C/W} = 38.52 \text{ °C/W}$$

Single Pulse:

These informations are for a single pulse on a cold resistor at 25 °C (not already used for a dissipation) and for pulses of 100 ms maximum duration.

The formula used to calculate E is:

$$E = P \times t = \frac{U^2}{R} \times t$$

with:

E (J): Pulse energy

P (W): Pulse power

t (s): Pulse duration

U (V): Pulse voltage

R (W): Resistor

The energy calculated must be less: than that allowed by the graph.

Repetitive or Superimposed Pulses:

The following formula is used to calculate the “equivalent” energy of a repetitive pulse or the “equivalent energy” of a pulse on a resistor that is already dissipating power.

$$E_c = E \times \left(1 + \frac{P_a}{P_r}\right)$$

with:

E_c (J): Equivalent pulse energy

E (J): Known pulse energy

P_r: Resistor power rating

P_a: Mean power being dissipated

The energy calculated must be less than that allowed by the graph and the average power dissipated (P_a) must not exceed the continuous power of resistor.

OVERLOADS

In any case the applied voltage must be lower than the maximum overload voltage of 750 V. The values indicated on the graph below are applicable to resistors in air or mounted onto a board.

ENERGY CURVE

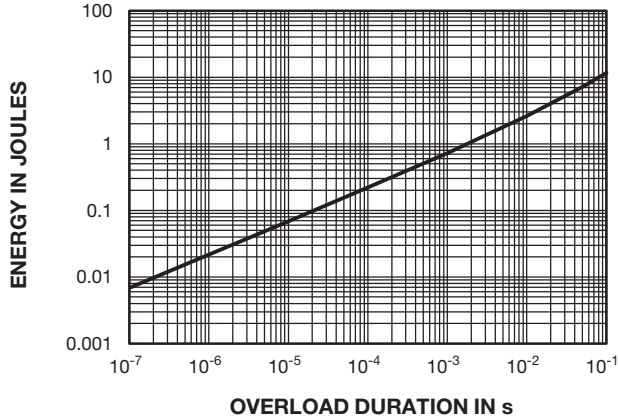

POWER CURVE

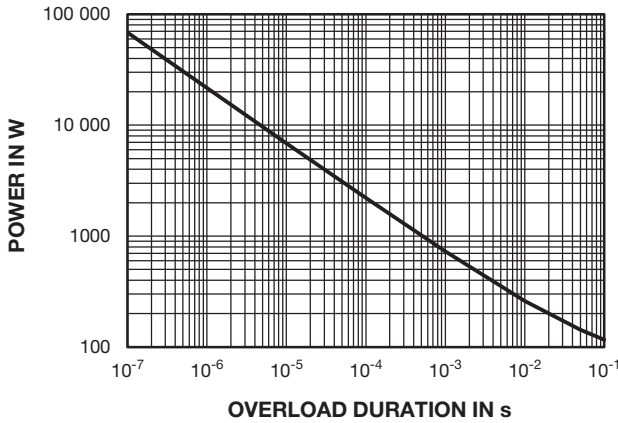

POWER RATING

The temperature of the case should be maintained within the limits specified.

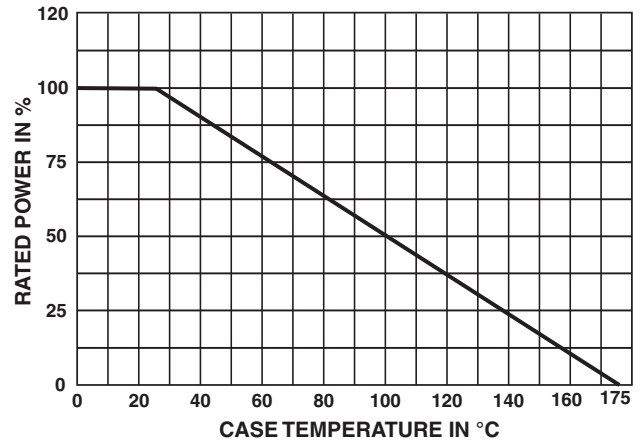

PACKAGING

- Reel
- Tube
- Tape dimensions (mm) for reel:

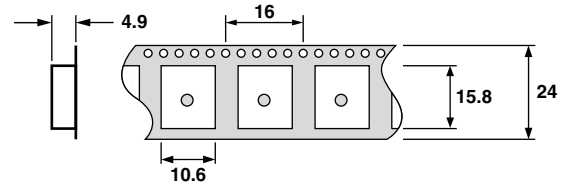

MARKING

Model, style, resistance value (in Ω), tolerance (in %), manufacturing date, Vishay Sfernice trademark



ORDERING INFORMATION

D2TO	35	C	100 kΩ	± 1 %	XXX	e3
MODEL	STYLE	CONNECTIONS	RESISTANCE VALUE	TOLERANCE	CUSTOM DESIGN	LEAD (Pb)-FREE
				F = ± 1 % G = ± 2 % J = ± 5 % K = ± 10 %	Optional on request: Shape, etc.	

SAP PART NUMBERING GUIDELINES

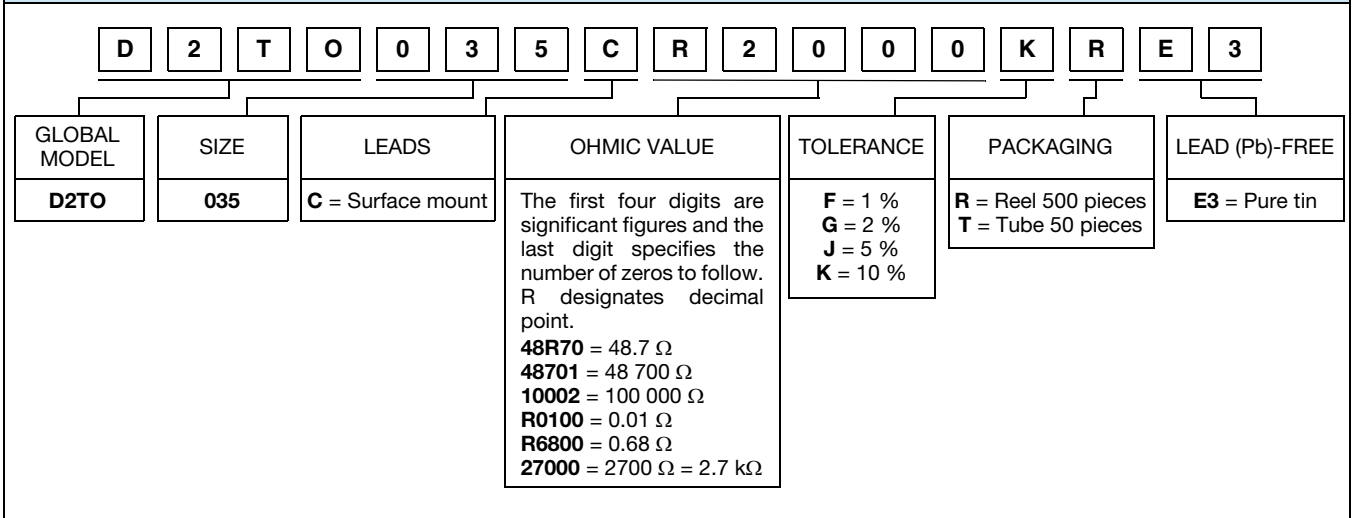



Disclaimer

ALL PRODUCT, PRODUCT SPECIFICATIONS AND DATA ARE SUBJECT TO CHANGE WITHOUT NOTICE TO IMPROVE RELIABILITY, FUNCTION OR DESIGN OR OTHERWISE.

Vishay Intertechnology, Inc., its affiliates, agents, and employees, and all persons acting on its or their behalf (collectively, "Vishay"), disclaim any and all liability for any errors, inaccuracies or incompleteness contained in any datasheet or in any other disclosure relating to any product.

Vishay makes no warranty, representation or guarantee regarding the suitability of the products for any particular purpose or the continuing production of any product. To the maximum extent permitted by applicable law, Vishay disclaims (i) any and all liability arising out of the application or use of any product, (ii) any and all liability, including without limitation special, consequential or incidental damages, and (iii) any and all implied warranties, including warranties of fitness for particular purpose, non-infringement and merchantability.

Statements regarding the suitability of products for certain types of applications are based on Vishay's knowledge of typical requirements that are often placed on Vishay products in generic applications. Such statements are not binding statements about the suitability of products for a particular application. It is the customer's responsibility to validate that a particular product with the properties described in the product specification is suitable for use in a particular application. Parameters provided in datasheets and/or specifications may vary in different applications and performance may vary over time. All operating parameters, including typical parameters, must be validated for each customer application by the customer's technical experts. Product specifications do not expand or otherwise modify Vishay's terms and conditions of purchase, including but not limited to the warranty expressed therein.

Except as expressly indicated in writing, Vishay products are not designed for use in medical, life-saving, or life-sustaining applications or for any other application in which the failure of the Vishay product could result in personal injury or death. Customers using or selling Vishay products not expressly indicated for use in such applications do so at their own risk. Please contact authorized Vishay personnel to obtain written terms and conditions regarding products designed for such applications.

No license, express or implied, by estoppel or otherwise, to any intellectual property rights is granted by this document or by any conduct of Vishay. Product names and markings noted herein may be trademarks of their respective owners.

Material Category Policy

Vishay Intertechnology, Inc. hereby certifies that all its products that are identified as RoHS-Compliant fulfill the definitions and restrictions defined under Directive 2011/65/EU of The European Parliament and of the Council of June 8, 2011 on the restriction of the use of certain hazardous substances in electrical and electronic equipment (EEE) - recast, unless otherwise specified as non-compliant.

Please note that some Vishay documentation may still make reference to RoHS Directive 2002/95/EC. We confirm that all the products identified as being compliant to Directive 2002/95/EC conform to Directive 2011/65/EU.

Vishay Intertechnology, Inc. hereby certifies that all its products that are identified as Halogen-Free follow Halogen-Free requirements as per JEDEC JS709A standards. Please note that some Vishay documentation may still make reference to the IEC 61249-2-21 definition. We confirm that all the products identified as being compliant to IEC 61249-2-21 conform to JEDEC JS709A standards.



Компания «ЭлектроПласт» предлагает заключение долгосрочных отношений при поставках импортных электронных компонентов на взаимовыгодных условиях!

Наши преимущества:

- Оперативные поставки широкого спектра электронных компонентов отечественного и импортного производства напрямую от производителей и с крупнейших мировых складов;
- Поставка более 17-ти миллионов наименований электронных компонентов;
- Поставка сложных, дефицитных, либо снятых с производства позиций;
- Оперативные сроки поставки под заказ (от 5 рабочих дней);
- Экспресс доставка в любую точку России;
- Техническая поддержка проекта, помощь в подборе аналогов, поставка прототипов;
- Система менеджмента качества сертифицирована по Международному стандарту ISO 9001;
- Лицензия ФСБ на осуществление работ с использованием сведений, составляющих государственную тайну;
- Поставка специализированных компонентов (Xilinx, Altera, Analog Devices, Intersil, Interpoint, Microsemi, Aeroflex, Peregrine, Syfer, Eurofarad, Texas Instrument, Miteq, Cobham, E2V, MA-COM, Hittite, Mini-Circuits, General Dynamics и др.);

Помимо этого, одним из направлений компании «ЭлектроПласт» является направление «Источники питания». Мы предлагаем Вам помощь Конструкторского отдела:

- Подбор оптимального решения, техническое обоснование при выборе компонента;
- Подбор аналогов;
- Консультации по применению компонента;
- Поставка образцов и прототипов;
- Техническая поддержка проекта;
- Защита от снятия компонента с производства.



Как с нами связаться

Телефон: 8 (812) 309 58 32 (многоканальный)

Факс: 8 (812) 320-02-42

Электронная почта: org@eplast1.ru

Адрес: 198099, г. Санкт-Петербург, ул. Калинина, дом 2, корпус 4, литера А.