

Automotive 5 V low drop voltage regulator

Datasheet - production data



- Precision output voltage 5 V +/-2%
- Reset circuit sensing the output voltage
- Programmable reset pulse delay with external capacitor
- Thermal shutdown and short circuit protection
- Wide temperature range (Tj = -40°C to 150°C)
- Enable input for enabling / disabling the voltage regulator

Features

Max DC supply voltage	V_s	40 V
Max output voltage tolerance	ΔV_0	+/-2 %
Max dropout voltage	V_{dp}	500 mV
Output current	I_o	300 mA
Quiescent current	I_{qn}	5 $\mu A^{(1)}$ 55 $\mu A^{(2)}$

1. Typical value with regulator disabled
2. Typical value with regulator enabled

- AEC-Q100 qualified
- Operating DC supply voltage range 5.6 V to 40 V
- Low dropout voltage
- 300 mA current capability
- Low quiescent current
- Very low consumption mode



Description

L5300AH7 is a low dropout linear regulator with microprocessor control functions such as power on reset, low voltage reset, ON/OFF control. In addition, only low value ceramic capacitor is required for stability (above or equal 220 nF).

Typical quiescent current is 60 μA at output current equal to 0 and enable high. It drops to 10 μA in “not enabled” mode.

On chip trimming results in high output voltage accuracy (+/-2%). Accuracy is kept over wide temperature range, line and load variation.

The maximum input voltage is 40 V. The max output current is internally limited. Internal temperature protection disables the voltage regulator output.

Table 1. Device summary

Package	Order codes	
	Tube	Tape and reel
HPAK	L5300AH7	L5300AH7TR

Contents

1	Block diagram and pins description	5
2	Electrical specifications	7
2.1	Absolute maximum ratings	7
2.2	Thermal data	7
2.3	Electrical characteristics	8
2.4	Electrical characteristics curves	10
3	Application information	14
3.1	Voltage regulator	14
3.2	Reset	16
3.3	Enable	16
4	Package and PC board thermal data	17
4.1	HPAK thermal data	17
5	Package and packing information	20
5.1	ECOPACK®	20
5.2	HPAK mechanical data	20
6	Revision history	22

List of tables

Table 1.	Device summary	1
Table 2.	Pins description	6
Table 3.	Absolute maximum ratings	7
Table 4.	Thermal data	7
Table 5.	General	8
Table 6.	Reset	9
Table 7.	Enable.	9
Table 8.	Thermal parameter	19
Table 9.	HPAK mechanical data	21
Table 10.	Document revision history	22

List of figures

Figure 1.	Block diagram	5
Figure 2.	Configuration diagram (top view)	5
Figure 3.	Output voltage vs T_j	10
Figure 4.	Output voltage vs V_S	10
Figure 5.	Output voltage vs V_{En}	10
Figure 6.	Drop voltage vs output current	10
Figure 7.	Current consumption vs output current	11
Figure 8.	Current consumption vs output current (at light load condition)	11
Figure 9.	Current consumption vs input voltage ($I_O = 0.1$ mA)	11
Figure 10.	Current consumption vs input voltage ($I_O = 100$ mA)	11
Figure 11.	Current limitation vs T_j	11
Figure 12.	Current limitation vs input voltage	11
Figure 13.	Short-circuit current vs T_j	12
Figure 14.	Short-circuit current vs input voltage	12
Figure 15.	V_{En_high} vs T_j	12
Figure 16.	V_{En_low} vs T_j	12
Figure 17.	V_{Rth} vs T_j	12
Figure 18.	V_{Rlth} vs T_j	12
Figure 19.	I_{cr} vs T_j	13
Figure 20.	I_{dr} vs T_j	13
Figure 21.	Application schematic	14
Figure 22.	Stability region	15
Figure 23.	Maximum load variation response	15
Figure 24.	Reset time diagram	16
Figure 25.	PC board	17
Figure 26.	$R_{thj-amb}$ vs PCB copper area in open box free air condition	17
Figure 27.	HPAK thermal impedance junction ambient single pulse	18
Figure 28.	Thermal fitting model of a single-channel HSD in HPAK	18
Figure 29.	HPAK dimension	20

1 Block diagram and pins description

Figure 1. Block diagram

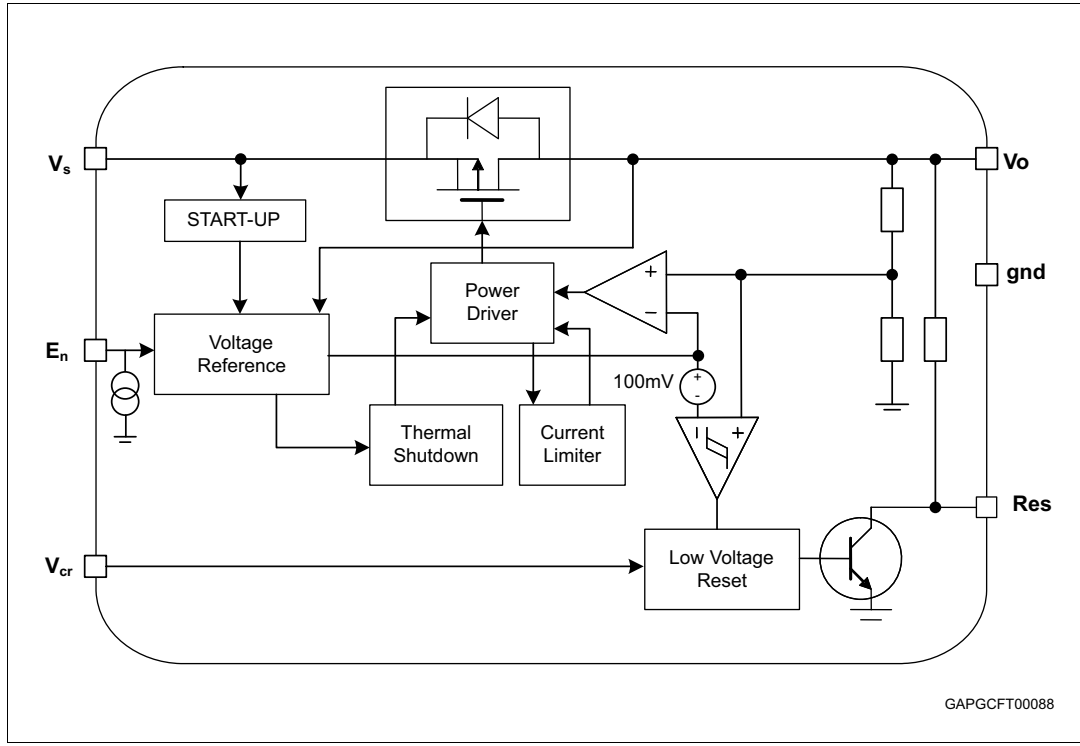

Figure 2. Configuration diagram (top view)

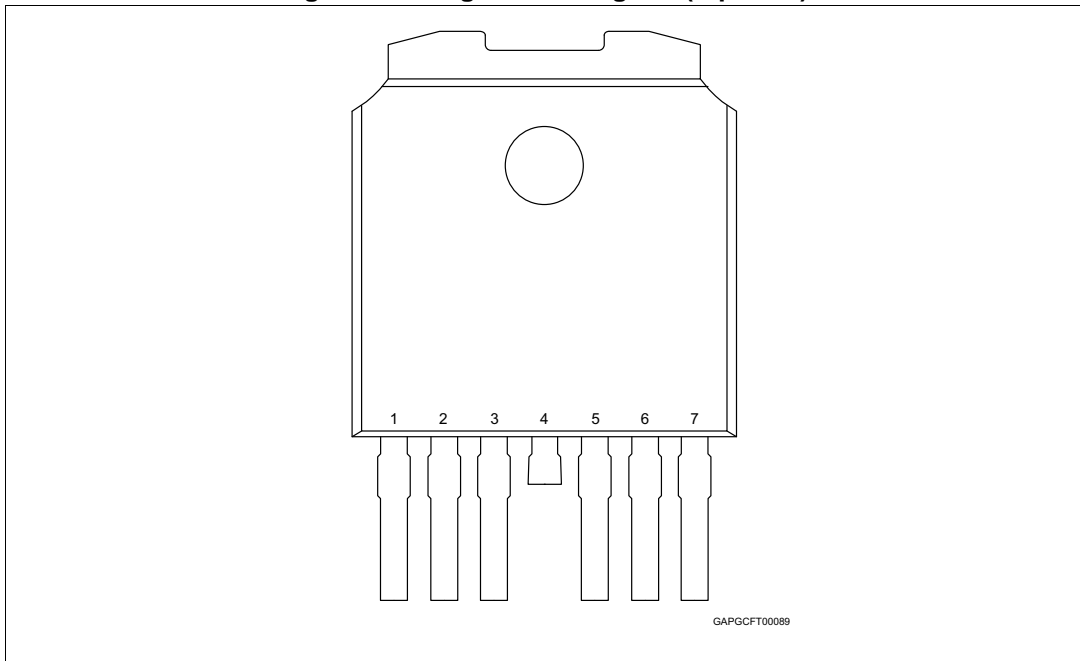

Table 2. Pins description

N°	Name	Function
1	V_S	Supply voltage, block directly to GND on the I_C with a capacitor.
2	E_n	Enable input. A high signal switches the regulator ON. Connect to V_S if not needed.
3	R_{es}	Reset output. Internally connected to V_o through a 20 K Ω pull up resistor. This pin is pulled low when $V_o < V_{o_th}$. Keep open if not needed.
4	GND	Ground reference.
5	V_{cr}	Reset delay. Connect an external capacitor between V_{cr} pin and ground to adjust the reset delay time. Keep open if not needed.
6	V_{os}	Output voltage sensing: this pin must be connected to V_o .
7	V_o	5 V regulated output. Block to GND with a ceramic capacitor (≥ 220 nF for regulator stability).

2 Electrical specifications

2.1 Absolute maximum ratings

Stressing the device above the rating listed in [Table 3: Absolute maximum ratings](#) may cause permanent damage to the device. These are stress ratings only and operation of the device at these or any other conditions above those indicated in the Operating sections of this specification is not implied. Exposure to Absolute Maximum Rating conditions for extended periods may affect device reliability.

Table 3. Absolute maximum ratings

Symbol	Parameter	Value	Unit
V_{sdc}	DC supply voltage	-0.3 to 40	V
I_{sdc}	Input current	Internally limited	
V_{odc}	DC output voltage	-0.3 to 6	V
I_{odc}	DC output current	Internally limited	
$V_{od Res}$	Open drain output voltage R_{es}	-0.3 to $V_{Vodc} + 0.3$	V
$I_{od Res}$	Open drain output current R_{es}	Internally limited	
V_{cr}	V_{cr} voltage	-0.3 to $V_{Vo} + 0.3$	V
V_{En}	Enable input	-0.3 to 40	V
T_j	Junction temperature	-40 to 150	°C
$V_{ESD HBM}$	ESD HBM voltage level (HBM-MIL STD 883C)	+/- 2	kV
$V_{ESD CDM}$	ESD CDM voltage level (CDM AEC-Q100-011)	+/- 750	V

2.2 Thermal data

Table 4. Thermal data

Symbol	Parameter	Value	Unit
$R_{thj-case}$	Thermal resistance junction to case	4.8	°C/W
$R_{thj-amb}$	Thermal resistance junction to ambient	45 ⁽¹⁾	K/W

1. The values quoted are for PCB 77 mm x 86 mm x 1.6 mm, FR4, double layer with thermal vias (one copper heatsink layer, thickness 0.070 mm, area 8 cm²).

2.3 Electrical characteristics

Values specified in this section are for $V_S = 5.6\text{ V to }31\text{ V}$, $T_J = -40\text{ °C to }150\text{ °C}$, unless otherwise stated.

Table 5. General

Pin	Symbol	Parameter	Test condition	Min	Typ	Max	Unit
V_o	V_{o_ref}	Output voltage	$V_S = 8\text{ to }18\text{ V}$ $I_O = 8\text{ to }300\text{ mA}$	4.9	5.0	5.1	V
V_o	V_{o_ref}	Output voltage	$V_S = 5.6\text{ to }31\text{ V}$ $I_O = 8\text{ to }300\text{ mA}$	4.85	5.0	5.15	V
V_o	V_{o_ref}	Output voltage	$V_S = 5.6\text{ to }31\text{ V}$ $I_O = 0.1\text{ mA to }8\text{ mA}$	4.75	5.0	5.25	V
V_o	I_{short}	Short circuit current	$V_S = 13.5\text{ V}$	0.8	1.8	2.6	A
V_o	I_{lim}	Output current limitation ⁽¹⁾	$V_S = 13.5\text{ V}$	0.6	1.6	2.5	A
V_S, V_o	V_{line}	Line regulation voltage	$V_S = 6\text{ V to }28\text{ V}$ $I_O = 50\text{ mA}$			40	mV
V_o	V_{load}	Load regulation voltage	$V_S = 13.5\text{ V}$ $I_O = 8\text{ mA to }300\text{ mA}$ $T_J = 25\text{ °C}$			40	mV
			$V_S = 8\text{ V to }18\text{ V}$ $I_O = 8\text{ mA to }300\text{ mA}$			55	mV
V_S, V_o	V_{dp}	Drop voltage ⁽²⁾	$I_O = 300\text{ mA}$			500	mV
V_S, V_o	SVR	Ripple rejection	$f_r = 100\text{ Hz}^{(3)}$		60		dB
V_o	I_{oth_H}	Normal consumption mode output current		8			mA
V_o	I_{oth_L}	Very low consumption mode output current				1.1	mA
V_o	I_{oth_Hyst}	Output current switching threshold hysteresis	$V_S = 13.5\text{ V}$, $T_J = 25\text{ °C}$		0.8		mA
V_S, V_o	I_{qs}	Current consumption with regulator disabled $I_{qs} = I_{VS} - I_O$	$V_S = 13.5\text{ V}$, $E_n = \text{low}$		5	10	μA
V_S, V_o	I_{qn_1}	Current consumption with regulator enabled $I_{qn_1} = I_{VS} - I_O$	$V_S = 13.5\text{ V}$, $I_O < 1\text{ mA}$, $E_n = \text{high}$		55	80	μA
V_S, V_o	I_{qn_300}	Current consumption with regulator enabled $I_{qn_300} = I_{VS} - I_O$	$V_S = 13.5\text{ V}$, $I_O = 300\text{ mA}$, $E_n = \text{high}$		3	4.2	mA
—	T_w	Thermal protection temperature		150		190	$^{\circ}\text{C}$
—	T_{w_hy}	Thermal protection temperature hysteresis			10		$^{\circ}\text{C}$

1. Measured output current when the output voltage has dropped 100 mV from its nominal value obtained at 13.5 V and $I_O = 75\text{ mA}$.

2. $V_S - V_o$ measured dropout when the output voltage has dropped 100 mV from its nominal value obtained at 13.5 V and $I_o = 75$ mA.
3. Guaranteed by design

Table 6. Reset

Pin	Symbol	Parameter	Test condition	Min	Typ	Max	Unit
R _{es}	V _{Res_l}	Reset output low voltage	R _{ext} = 5 kΩ V _o > 1 V			0.4	V
R _{es}	I _{Res_lkg}	Reset output high leakage current	V _{Res} = V _o			1	μA
R _{es}	R _{Res}	Pull up internal resistance	Versus V _o	10	20	40	kΩ
R _{es}	V _{o_th}	V _o out of regulation threshold	V _o decreasing	6%	8%	10%	Below V _{o_ref}
V _{cr}	V _{Rlth}	Reset timing low threshold	V _S = 13.5 V	16%	19%	22%	V _{o_ref}
V _{cr}	V _{Rhth}	Reset timing high threshold	V _S = 13.5 V	47%	50%	53%	V _{o_ref}
V _{cr}	I _{cr}	Charge current	V _S = 13.5 V	10	20	30	μA
V _{cr}	I _{dr}	Discharge current	V _S = 13.5 V	10	20	30	μA
R _{es}	T _{rr}	Reset reaction time	V _o = V _{o_th} - 100 mV			2	μs
R _{es}	T _{rd}	Reset delay time	V _S = 13.5 V, C _{tr} = 1 nF	2	4	6	ms

Table 7. Enable

Pin	Symbol	Parameter	Test condition	Min.	Typ.	Max.	Unit
E _n	V _{En_low}	E _n input low voltage				1	V
E _n	V _{En_high}	E _n input high voltage		3			V
E _n	V _{En_hyst}	E _n input hysteresis			500		mV
E _n	I _{leak}	Pull down current	V _{En} = 5 V		3	10	μA

2.4 Electrical characteristics curves

Figure 3. Output voltage vs T_j

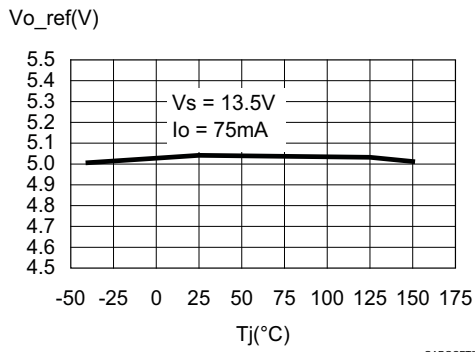

GAPGCFT00090

Figure 4. Output voltage vs V_s

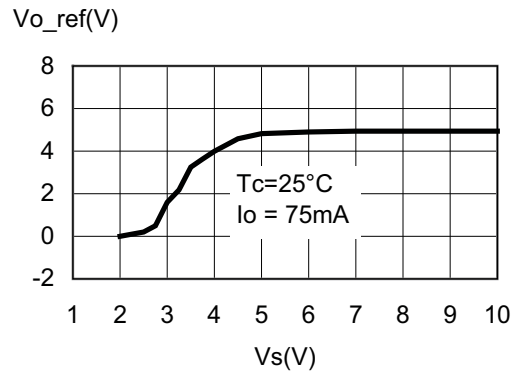

GAPGCFT00091

Figure 5. Output voltage vs V_{En}

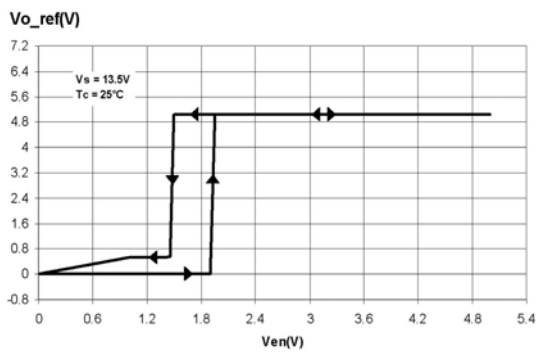

GAPGCFT00092

Figure 6. Drop voltage vs output current

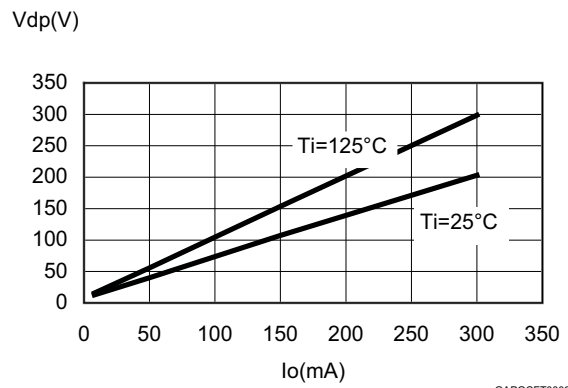

GAPGCFT00093

Figure 7. Current consumption vs output current

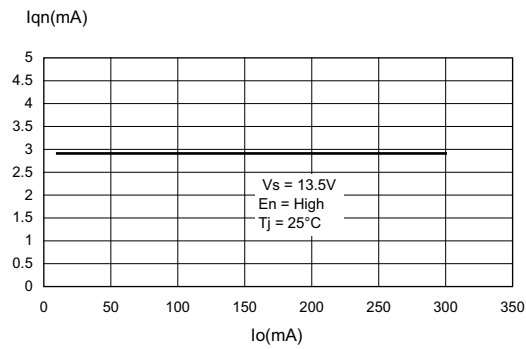

GAPGCFT00095

Figure 8. Current consumption vs output current (at light load condition)

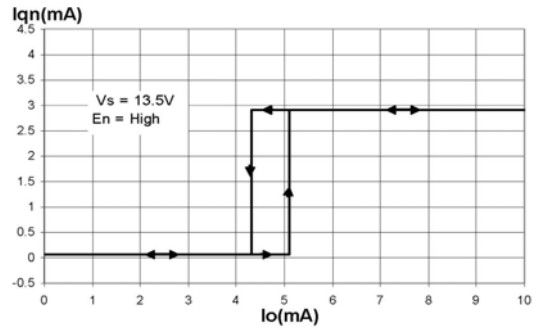

GAPGCFT00096

Figure 9. Current consumption vs input voltage (Io = 0.1 mA)

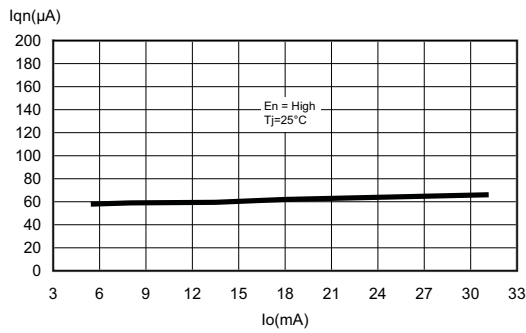

GAPGCFT00097

Figure 10. Current consumption vs input voltage (Io = 100 mA)

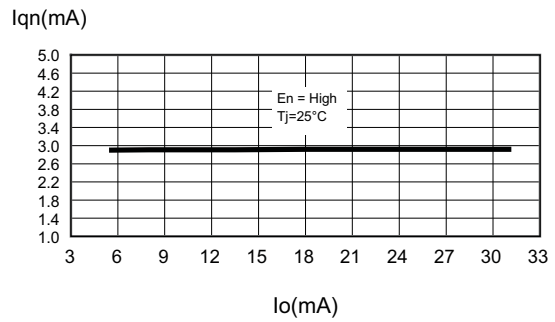

GAPGCFT00098

Figure 11. Current limitation vs T_j

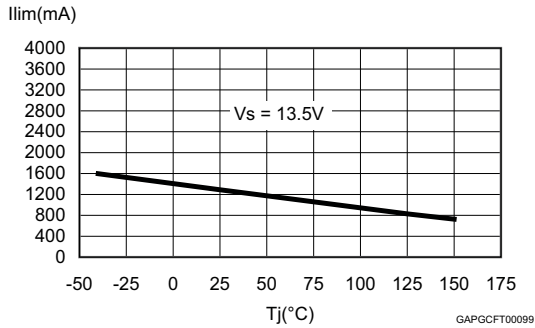

Figure 12. Current limitation vs input voltage

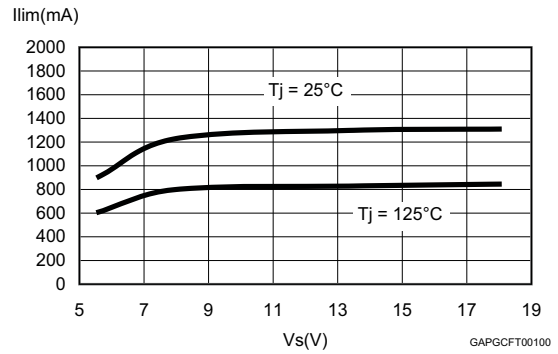

Figure 13. Short-circuit current vs T_j

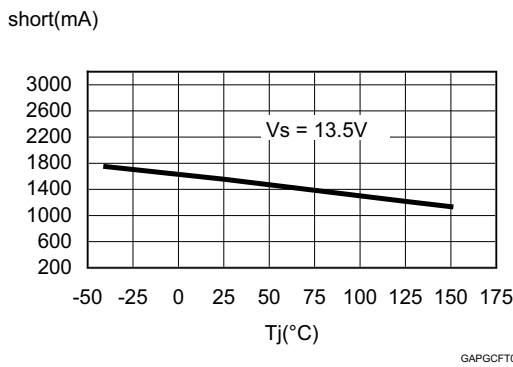

Figure 14. Short-circuit current vs input voltage

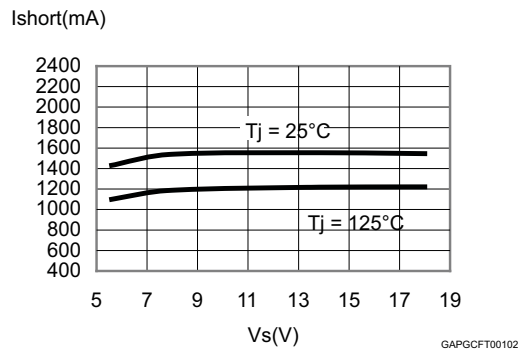

Figure 15. V_{En_high} vs T_j

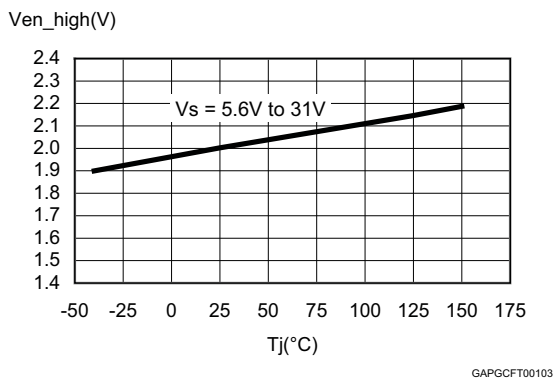
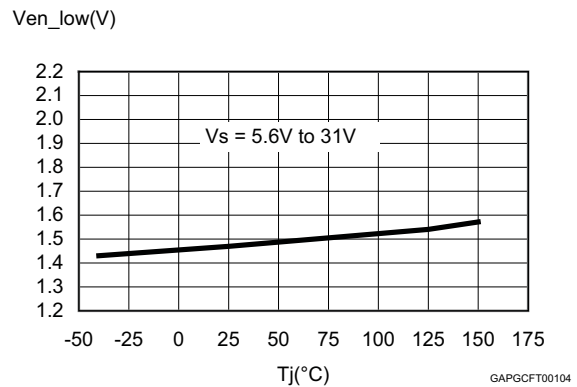
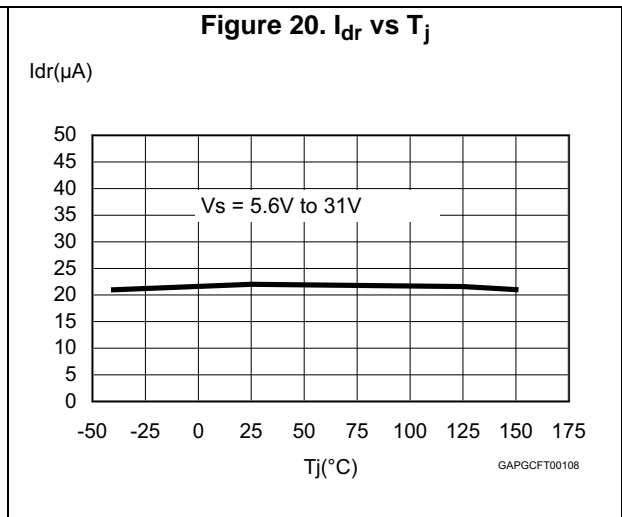
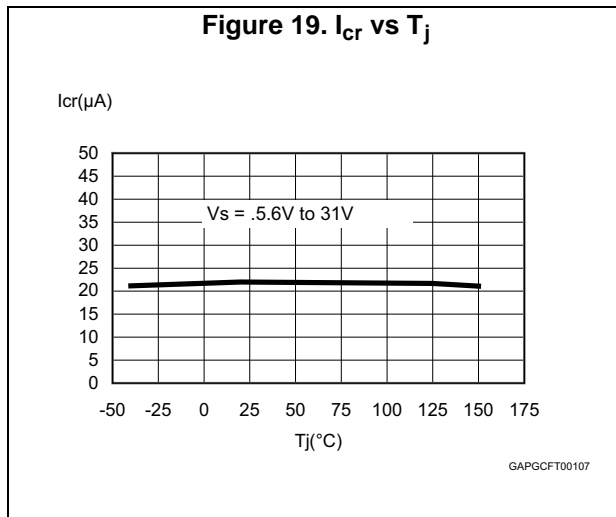
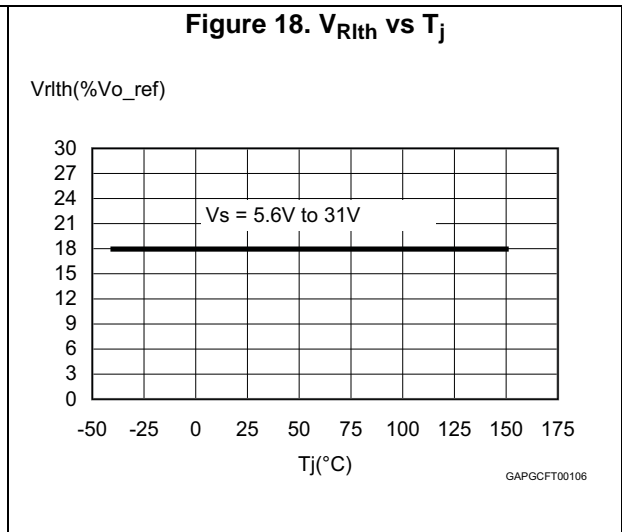
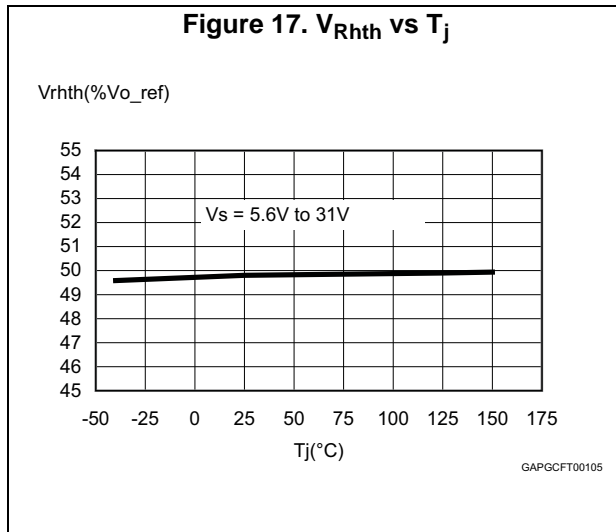

Figure 16. V_{En_low} vs T_j





3 Application information

3.1 Voltage regulator

The voltage regulator uses a P-channel MOS transistor as a regulating element. With this structure a very low dropout voltage at current up to 300 mA is obtained. The output voltage is regulated up to input supply voltage of 40 V. The high-precision of the output voltage ($\pm 2\%$) is obtained with a pre-trimmed reference voltage. The voltage regulator automatically adapts its own quiescent current to the output current level. In light load conditions the quiescent current goes down to 55 μA only (low consumption mode). This procedure features a certain hysteresis on the output current (see [Figure 8](#)). Short-circuit protection to GND and a thermal shutdown are provided.

Figure 21. Application schematic

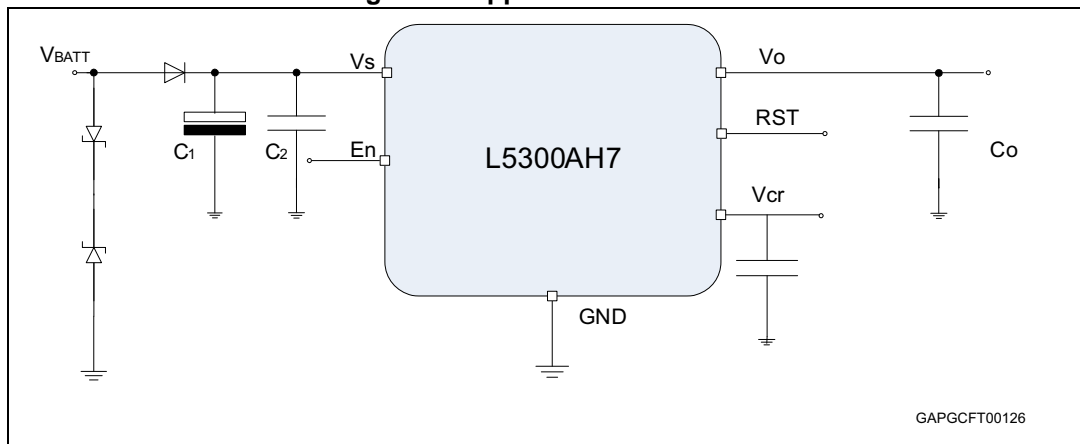

The input capacitor $C_1 \geq 100 \mu\text{F}$ is necessary as backup supply for negative pulses which may occur on the line. The second input capacitor $C_2 \geq 220 \text{ nF}$ is needed when the C_1 is too distant from the V_S pin and it compensates smooth line disturbances. The C_0 ceramic capacitor, connected to the output pin, is for bypassing to GND the high-frequency noise and it guarantees stability even during sudden line and load variations. Suggested value is $C_0 = 220 \text{ nF}$ with $\text{ESR} \geq 100 \text{ m}\Omega$.

Stability region is reported in [Figure 22](#).

Figure 22. Stability region

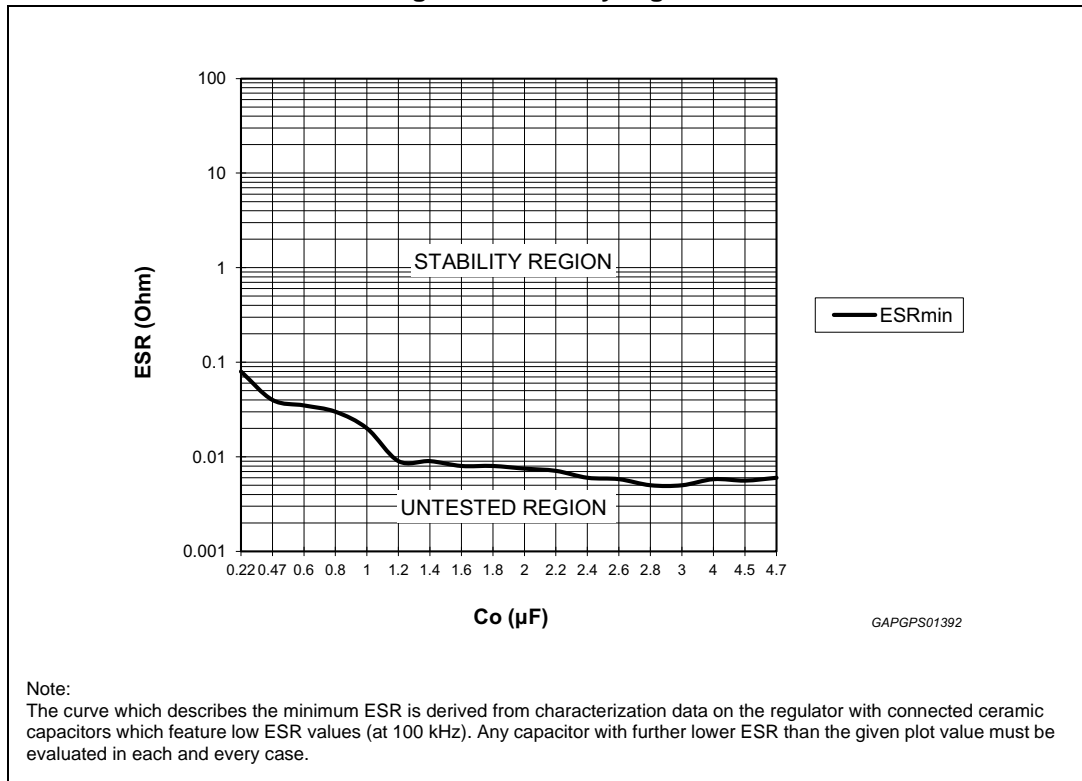
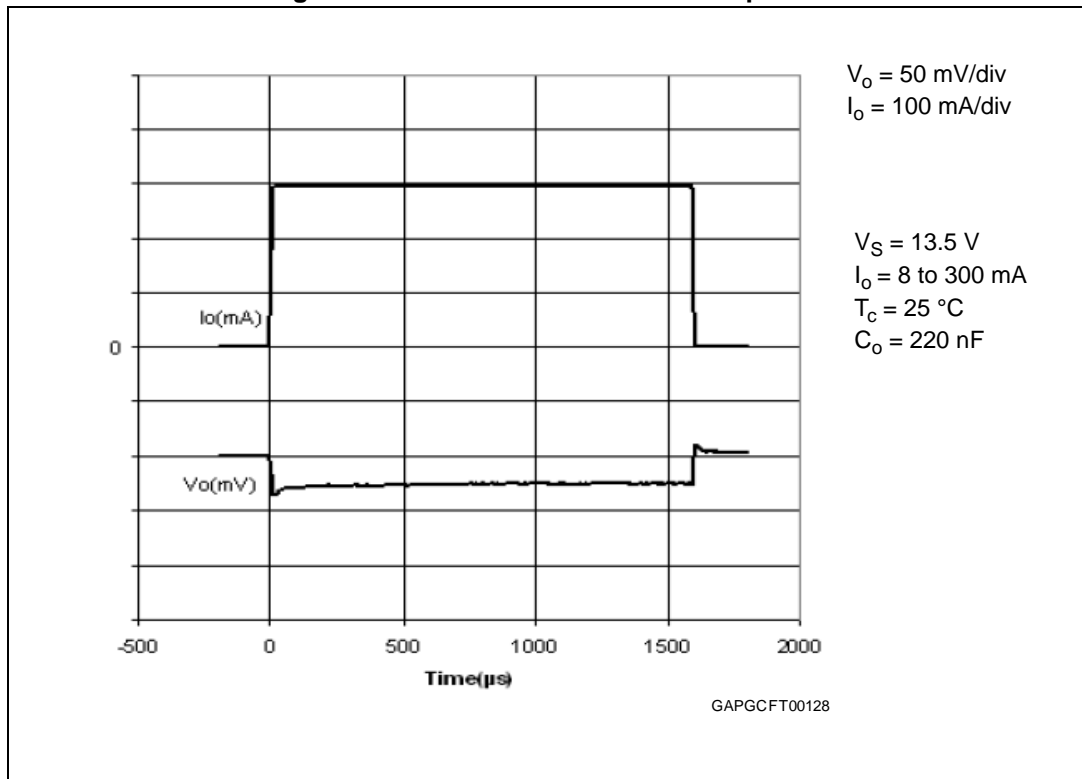

Figure 23. Maximum load variation response



3.2 Reset

The reset circuit monitors the output voltage V_o . If the output voltage becomes lower than V_{o_th} then R_{es} goes low with a delay time (t_{rr}). When the output voltage becomes higher than V_{o_th} then R_{es} goes high with a delay time T_{rd} . This delay is obtained by 512 periods of oscillator. The oscillator period is given by:

Equation 1

$$T_{osc} = [(V_{Rthh} - V_{Rlth}) \times C_{tr}] / I_{cr} + [(V_{Rthh} - V_{Rlth}) \times C_{tr}] / I_{dr}$$

and reset pulse delay T_{rd} is given by:

Equation 2

$$t_{rd} = 32 \times T_{osc}$$

Where:

$I_{cr} = 20 \mu A$ is an internally generated charge current,

$I_{dr} = 20 \mu A$ is an internally generated discharge current,

$V_{Rthh} = 2.5V$ (typ) and $V_{Rlth} = 0.95V$ (typ) are two voltage thresholds,

C_{tr} is an external capacitor put between V_{cr} pin and GND.

Figure 24. Reset time diagram

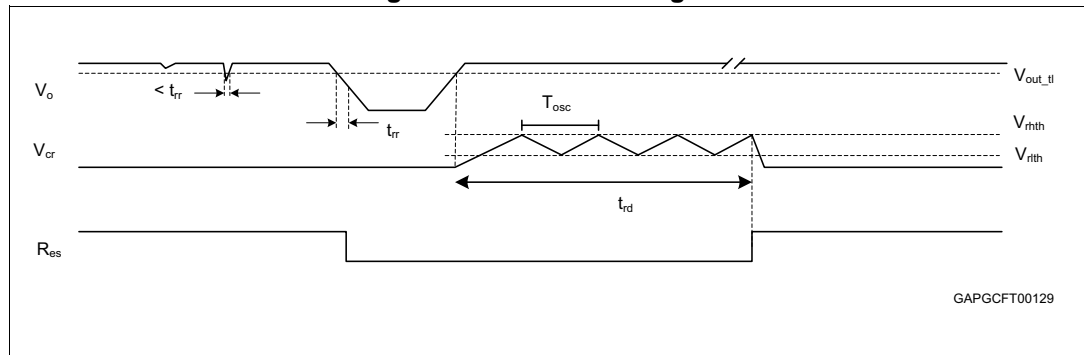

3.3 Enable

L5300AH7 is also provided by an enable input, a high signal switches the regulator ON. In standby mode the output is disabled and the current consumption of the device (quiescent current) is less than $10 \mu A$.

4 Package and PC board thermal data

4.1 HPAK thermal data

Figure 25. PC board

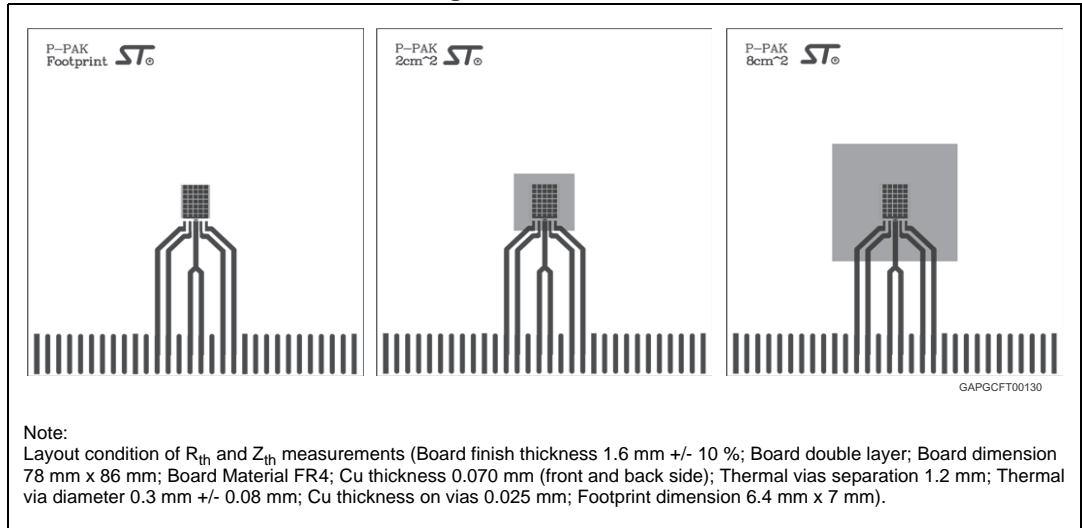

Figure 26. $R_{thj-amb}$ vs PCB copper area in open box free air condition

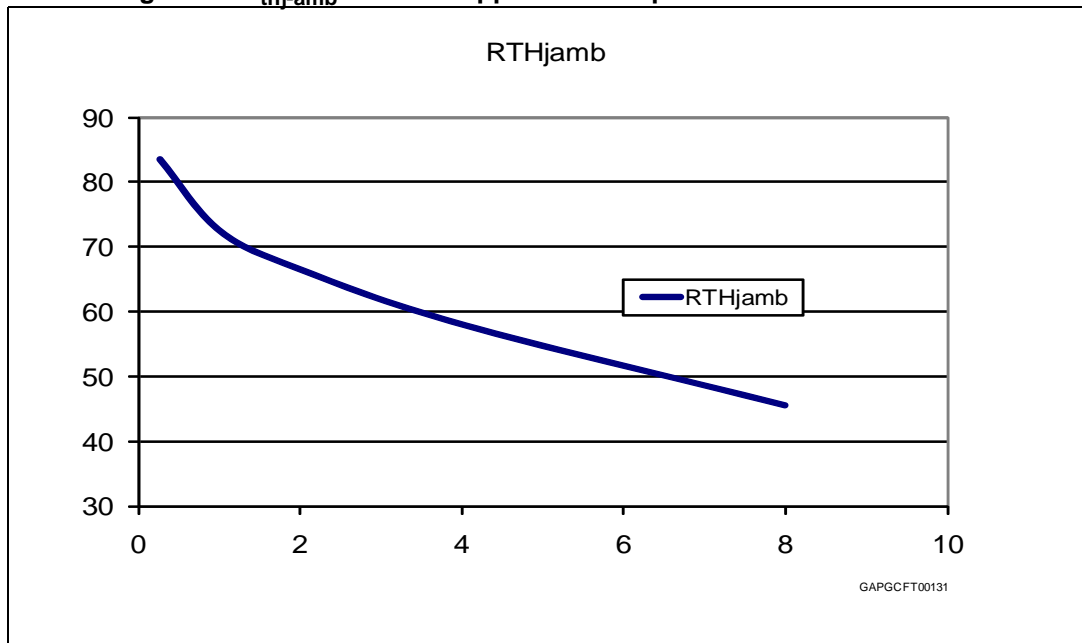

Figure 27.HPAK thermal impedance junction ambient single pulse

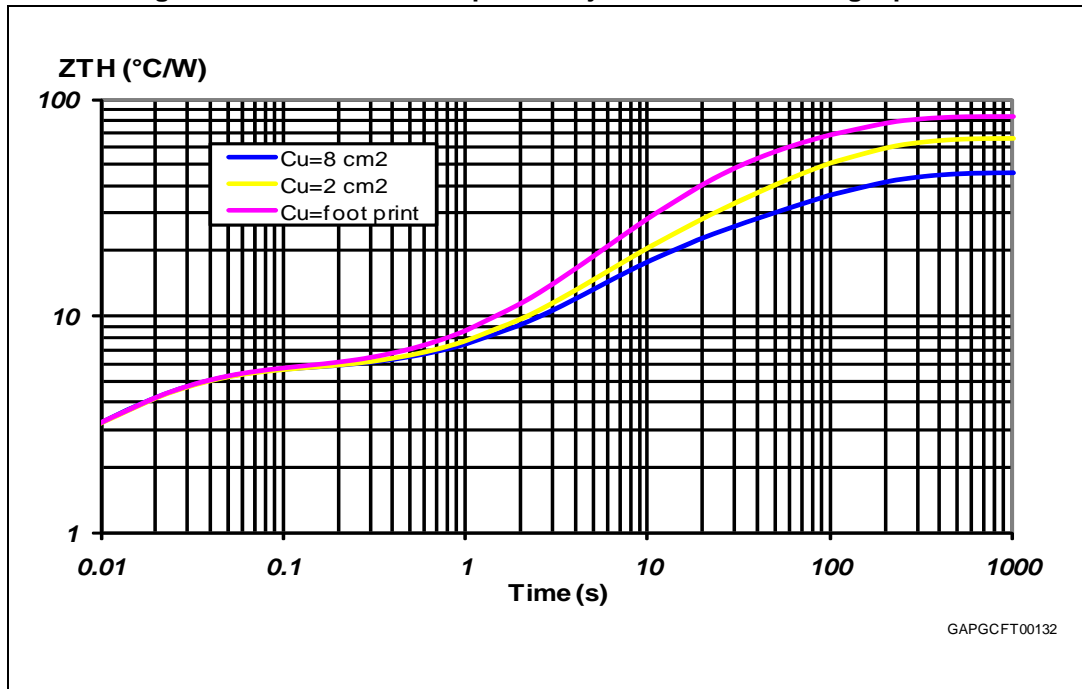
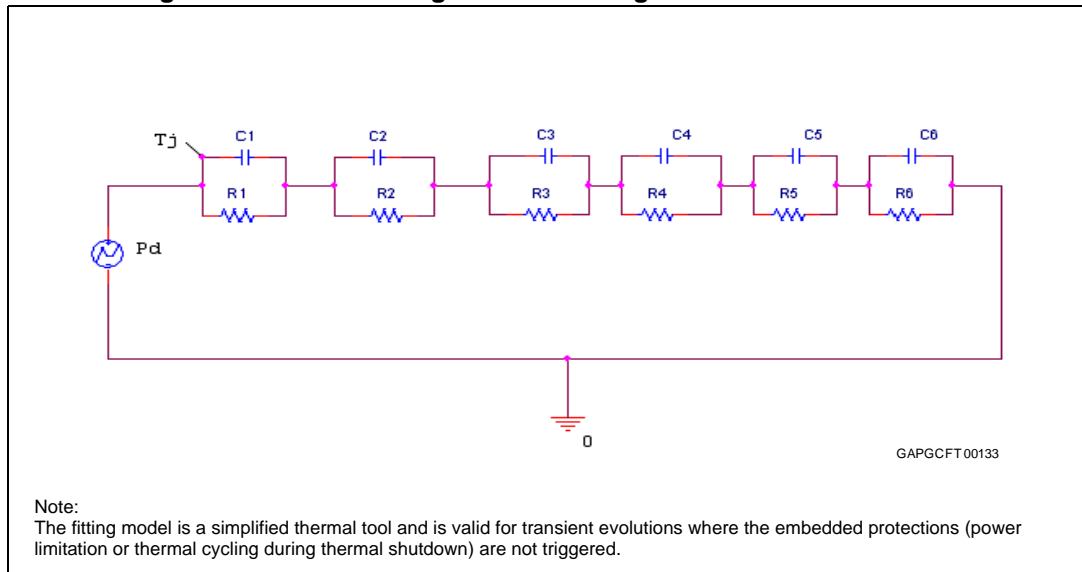

Figure 28.Thermal fitting model of a single-channel HSD in HPAK



Equation 3: pulse calculation formula

$$Z_{TH\delta} = R_{TH} \cdot \delta + Z_{THtp}(1 - \delta)$$

where $\delta = t_p/T$

Table 8. Thermal parameter

Area/island (cm ²)	Footprint	4	8
R1 (°C/W)	3		
R2 (°C/W)	4		
R3 (°C/W)	6		
R4 (°C/W)	7		
R5 (°C/W)	28	18.5	11
R6 (°C/W)	31	22	14
C1 (W.s/°C)	0.0005		
C2 (W.s/°C)	0.001		
C3 (W.s/°C)	0.005		
C4 (W.s/°C)	0.05		
C5 (W.s/°C)	0.8	2	3
C6 (W.s/°C)	3	6	9

5 Package and packing information

5.1 ECOPACK®

In order to meet environmental requirements, ST offers these devices in different grades of ECOPACK® packages, depending on their level of environmental compliance. ECOPACK® specifications, grade definitions and product status are available at: www.st.com. ECOPACK® is an ST trademark.

5.2 HPAK mechanical data

Figure 29.HPAK dimension

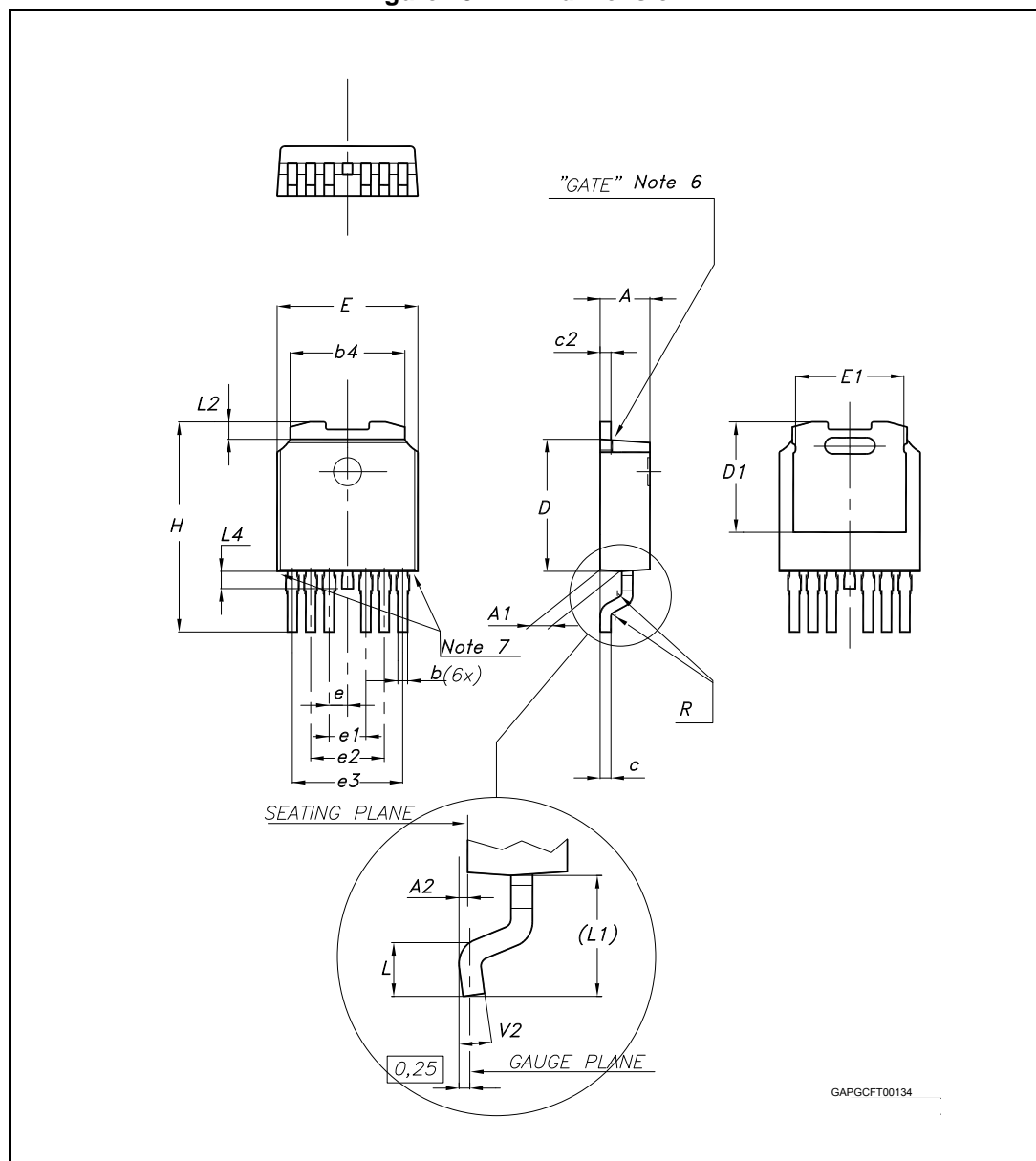

Table 9. HPAK mechanical data

Dim	Millimeter		
	Nom	Min	Max
A		2.20	2.40
A1		0.90	1.10
A1		0.03	0.23
b		0.45	0.60
b4		5.20	5.40
c		0.45	0.60
c2		0.48	0.60
D		6.00	6.20
D1	5.10		
E		6.40	6.60
E1	5.20		
e	0.85		
e1		1.60	1.80
e2		3.30	3.50
e3		5.00	5.20
H		9.35	10.10
L		1	
(L1)	2.80		
L2	0.80		
L4		0.60	1.00
R	0.20		
V2		0°	8°

6 Revision history

Table 10. Document revision history

Date	Revision	Changes
09-Aug-2007	1	Initial release.
15-Oct-2007	2	<p>Changed features table on the cover page:</p> <ul style="list-style-type: none"> - quiescent current with regulator disabled changed from 10 to 5 μA. - quiescent current with regulator enabled changed from 60 to 55 μA. <p>Table 5: General - Added typical value of I_{qs} and I_{qn_1} parameters.</p>
12-Mar-2009	3	<p>Changed features table on the cover page</p> <p>Table 5: General</p> <ul style="list-style-type: none"> - V_{o_ref}: deleted row and added 3 new rows <p>Table 6: Reset</p> <ul style="list-style-type: none"> - I_{Res_lkg}: deleted Test condition - V_{o_th}: deleted $I_O = 1$ to 300 mA and $V_S = 5.6$ to 31V, added "V_o decreasing" for test condition - V_{Rlth}: changed min/typ/max values - T_{rd}: changed min/typ/max values <p>Updated Table 7: Enable</p> <p>Section 3.2: Reset</p> <ul style="list-style-type: none"> - t_{rd}: changed coefficient - V_{Rlth}: changed coefficient
23-Jul-2010	4	<p>Changed status from target specification to preliminary data.</p> <p>Updated following tables:</p> <ul style="list-style-type: none"> - Table 4: Thermal data - Table 5: General <p>Added Section 2.4: Electrical characteristics curves.</p> <p>Added Chapter 4: Package and PC board thermal data</p>
02-Sep-2010	5	Updated Figure 27: HPAK thermal impedance junction ambient single pulse
15-Sep-2010	6	Updated Table 4: Thermal data
12-Oct-2010	7	Updated Section 3.1: Voltage regulator

Table 10. Document revision history (continued)

Date	Revision	Changes
09-Mar-2011	8	<p>Updated following tables:</p> <p><i>Table 2: Pins description:</i></p> <ul style="list-style-type: none"> – Updated pins sequence <p><i>Table 3: Absolute maximum ratings:</i></p> <ul style="list-style-type: none"> – I_{sdc}: changed symbol from I_{VsdC} – I_{odc}: changed symbol from I_{VodC} <p><i>Table 5: General:</i></p> <ul style="list-style-type: none"> – I_{short}: changed min/typ/max value – I_{lim}: changed min/typ/max value, changed parameter – V_{line}: changed test condition – I_{qn_300}: changed typ value – Updated tablefootnote <p><i>Table 6: Reset:</i></p> <ul style="list-style-type: none"> – V_{Res_I}: changed test condition – V_{Res_Ikg}: added test condition <p><i>Table 7: Enable:</i></p> <ul style="list-style-type: none"> – I_{leak}: changed typ value <p>Updated <i>Section 3.2: Reset</i></p>
18-Nov-2011	9	<p><i>Table 9: HPAK mechanical data:</i></p> <ul style="list-style-type: none"> – b: updated values
26-Jan-2012	10	Updated <i>Figure 22: Stability region on page 15.</i>
07-Feb-2012	11	Modified <i>Figure 22: Stability region on page 15.</i>
13-Sep-2013	12	Updated disclaimer.
21-Sep-2018	13	Updated template. Updated title and <i>Features.</i>

IMPORTANT NOTICE – PLEASE READ CAREFULLY

STMicroelectronics NV and its subsidiaries ("ST") reserve the right to make changes, corrections, enhancements, modifications, and improvements to ST products and/or to this document at any time without notice. Purchasers should obtain the latest relevant information on ST products before placing orders. ST products are sold pursuant to ST's terms and conditions of sale in place at the time of order acknowledgement.

Purchasers are solely responsible for the choice, selection, and use of ST products and ST assumes no liability for application assistance or the design of Purchasers' products.

No license, express or implied, to any intellectual property right is granted by ST herein.

Resale of ST products with provisions different from the information set forth herein shall void any warranty granted by ST for such product.

ST and the ST logo are trademarks of ST. All other product or service names are the property of their respective owners.

Information in this document supersedes and replaces information previously supplied in any prior versions of this document.

© 2018 STMicroelectronics – All rights reserved



Компания «ЭлектроПласт» предлагает заключение долгосрочных отношений при поставках импортных электронных компонентов на взаимовыгодных условиях!

Наши преимущества:

- Оперативные поставки широкого спектра электронных компонентов отечественного и импортного производства напрямую от производителей и с крупнейших мировых складов;
- Поставка более 17-ти миллионов наименований электронных компонентов;
- Поставка сложных, дефицитных, либо снятых с производства позиций;
- Оперативные сроки поставки под заказ (от 5 рабочих дней);
- Экспресс доставка в любую точку России;
- Техническая поддержка проекта, помощь в подборе аналогов, поставка прототипов;
- Система менеджмента качества сертифицирована по Международному стандарту ISO 9001;
- Лицензия ФСБ на осуществление работ с использованием сведений, составляющих государственную тайну;
- Поставка специализированных компонентов (Xilinx, Altera, Analog Devices, Intersil, Interpoint, Microsemi, Aeroflex, Peregrine, Syfer, Eurofarad, Texas Instrument, Miteq, Cobham, E2V, MA-COM, Hittite, Mini-Circuits, General Dynamics и др.);

Помимо этого, одним из направлений компании «ЭлектроПласт» является направление «Источники питания». Мы предлагаем Вам помощь Конструкторского отдела:

- Подбор оптимального решения, техническое обоснование при выборе компонента;
- Подбор аналогов;
- Консультации по применению компонента;
- Поставка образцов и прототипов;
- Техническая поддержка проекта;
- Защита от снятия компонента с производства.



Как с нами связаться

Телефон: 8 (812) 309 58 32 (многоканальный)

Факс: 8 (812) 320-02-42

Электронная почта: org@eplast1.ru

Адрес: 198099, г. Санкт-Петербург, ул. Калинина, дом 2, корпус 4, литера А.