

INTRODUCTIONS

1. Designed as a general purpose filter providing effective EMI suppression.
2. All part numbers are UL recognized, CSA certified and VDE approved.

COMPONENTS

PART NO.	Cx (uF)	L (mH)	Cy (pF)	R (Ω)
02DBAG5	0.1	1.1	3300	-
02DBAW5				
03DBAG5				
03DBAW5				
05DBAG5				
05DBAW5	2.9			
• 05DBDG3	0.22	2.1	-	-
• 05DBDW3				
06DBDW3S	0.47	3.7	330K	
10DBAG5	0.1	1.5	3300	-
10DBAW5				
10DBAS5				
10DBDW3S	0.47	1.45	330K	
10DBDG3S				
* 16DBDG3	1.0	3.6	10000	200K
* 16DBC5	2.2			
20DBAG5	0.33	0.7	3300	-
20DBAS5				
12DBBG5B	0.1	0.7	4700	1.0M
12DBBW5B				
16DBC5B				
16DBCW5B				
20DBC5B				
20DBC5B				
30DBCS5B	0.47	0.67	10000	

- UL & CSA approved only.
- * No safety approval yet

MINIMUM INSERTION LOSS IN dB

COMMON MODE (L-G) IN 50 OHM SYSTEM						
CURRENT RATING	FREQUENCY-MHz					
	.15	.50	1.0	5.0	10	30
2,3,5A	15	30	38	45	45	40
6A	20	25	35	40	45	35
10A	20	30	35	50	50	45
* 10A	15	22	30	40	40	45
16A(DG3)	20	30	35	45	50	35
* 16A(CG5)	20	30	35	50	50	40
20A	13	20	25	40	45	45
12A (BG5B) (BW5B)	10	20	22	35	40	40
16A (CG5B) (CW5B)	10	18	20	35	50	30
20A (CG5B) (CS5B)	10	20	22	30	35	35
30A (CS5B)	10	28	30	45	50	35
DIFFERENTIAL MODE (L-L) IN 50 OHM SYSTEM						
2,3,5A	6	15	20	40	45	45
6A	10	18	20	30	35	40
10A	6	15	20	44	45	45
* 10A	12	18	20	35	35	40
16A (DG3)	10	30	50	50	50	50
* 16A (CG5)	20	30	40	45	40	30
20A	15	24	28	45	45	45
12A (BG5B) (BW5B)	5	12	15	35	45	35
16A (CG5B) (CW5B)	5	10	15	45	45	40
20A (CG5B) (CS5B)	4	10	15	45	45	40
30A (CS5B)	12	20	25	45	50	45

* 10DBDG3S, DW3S

SPECIFICATIONS

1. Maximum leakage current each
line-to-ground @ 115VAC 60Hz: 0.25mA
1.0mA (10000pF)
@ 250VAC 50Hz: 0.45mA
2.0mA (10000pF)
2. Hipot rating (one minute)
line-to-ground: 2250VDC
line-to-line: 1450VDC
3. Operating frequency: 50/60Hz
4. Rated voltage: 115/250VAC

SERIES DIMENSIONS

CURRENT RATING	STYLE	DIMENSIONS IN INCHES/mm				
		A	B	C	D	E
2A	AG5	2.15	-	0.65	-	2.54
		54.6				
	0.96					
2A	AW5	24.4	-	16.5	-	64.5
		2.54				
	64.5					
3A	AG5	1.33	1.77	0.77	2.13	2.50
		33.8				
	33.8					
3A	AW5	2.54	45.0	19.5	54.1	63.5
		64.5				
	1.33					
5A	AG5	2.54	45.0	19.5	54.1	63.5
		64.5				
	1.33					
5A	AW5	33.8	45.0	19.5	54.1	63.5
		33.8				
	33.8					
6A	DW3S	2.55	2.08	1.29	1.575	0.61
		64.77	52.83	32.77	40.01	15.49
10A	AG5	2.54	1.77	1.18	2.13	2.50
		64.5				
		1.33				
	AW5	33.8	45.0	30.0	54.1	64.8
		33.8				
	33.8					
	AS5	3.10	2.02	1.18	2.38	2.77
78.7		51.3	30.0	60.5	70.3	
DW3S	2.55	2.08	1.29	1.575	0.61	
	64.80	52.80	32.80	40.00	15.50	
DG3S	3.14	2.10	1.28	1.575	0.61	
	79.80	53.30	32.50	40.00	15.50	
	3.14	2.10	1.28	1.575	0.61	
16A	DG3	4.35	1.34	1.65	2.24	0.63
		110.50	34.0	42.0	57.0	16.0
	CG5	3.75	2.06	1.54	2.94	3.34
		95.25	52.30	39.10	74.70	84.80
20A	AG5	3.25	2.02	1.16	2.38	2.75
		82.5	51.3	29.5	60.5	69.9
	AS5	3.37	2.02	1.15	2.38	2.77

CURRENT RATING	STYLE	DIMENSIONS IN INCHES/mm					
		A	B	C	D	E	F
12A	BG5B	2.13	2.54	1.34	1.77	-	-
	BW5B	54.00	64.5	34.0	45.0		
16A	CG5B	2.40	2.81	1.79	2.02	1.18	-
	CW5B	61.00	71.5	45.5	51.3		
20A	CG5B	2.95	3.34	2.04	2.52	-	-
	CS5B	75.00	84.8	51.8	64.0		
30A	CS5B	4.06	4.49	2.22	3.74	1.83	-
		103.0	114.0	56.5	95.0	46.4	

ELECTRICAL SCHEMATIC

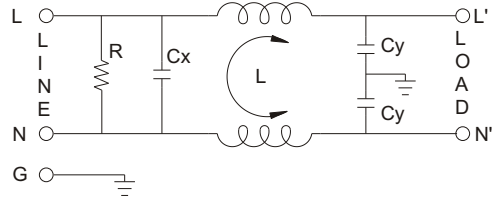
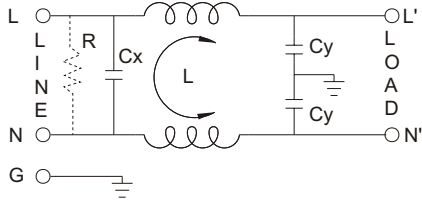

XXDBXX5B

INSERTION LOSS (TYPICAL)

02DBAG5----- COMMON MODE ----- DIFF. MODE
03DBAG5----- COMMON MODE ----- DIFF. MODE

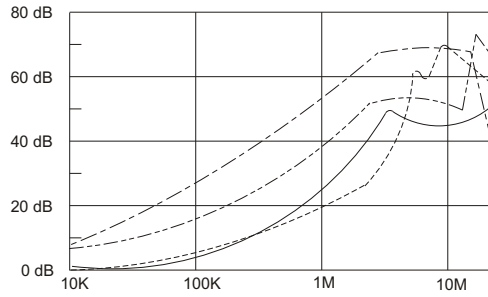

05DBAG5----- COMMON MODE ----- DIFF. MODE
10DBAG5----- COMMON MODE ----- DIFF. MODE

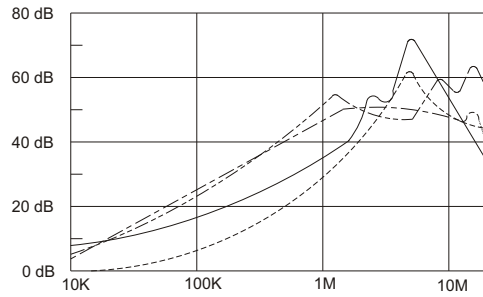

20DBAG5----- COMMON MODE ----- DIFF. MODE

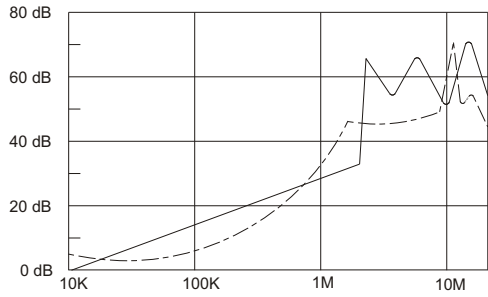

20DBC5B ----- COMMON MODE ----- DIFF. MODE
20BCS5B ----- COMMON MODE ----- DIFF. MODE
30BCS5B ----- COMMON MODE ----- DIFF. MODE

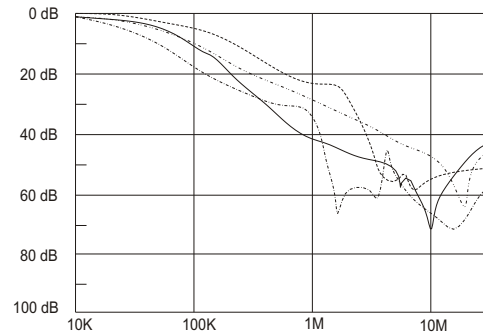

12DBBG5B ----- COMMON MODE ----- DIFF. MODE
12DBBW5B ----- COMMON MODE ----- DIFF. MODE

16DBC5B ----- COMMON MODE ----- DIFF. MODE
16DBCW5B ----- COMMON MODE ----- DIFF. MODE

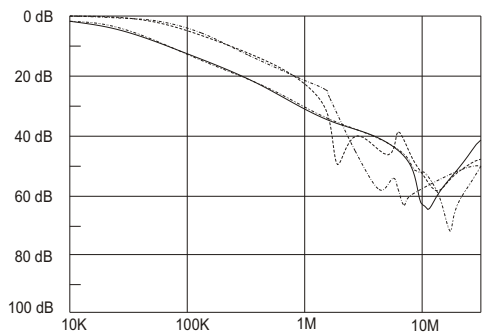

MECHANICAL CONSTRUCTION

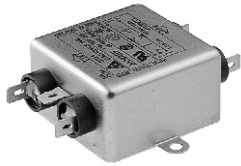

AG5

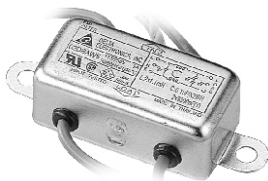
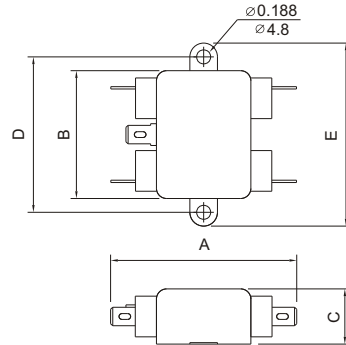

AW5

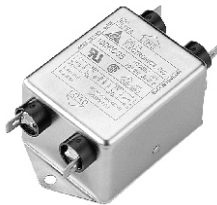
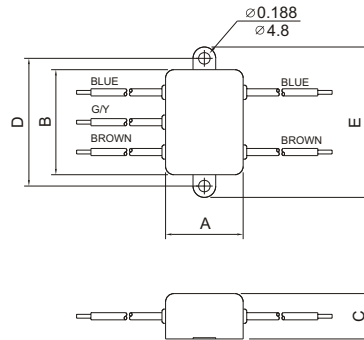

CG5

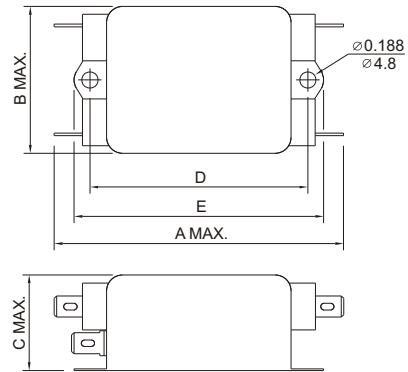

DW3S

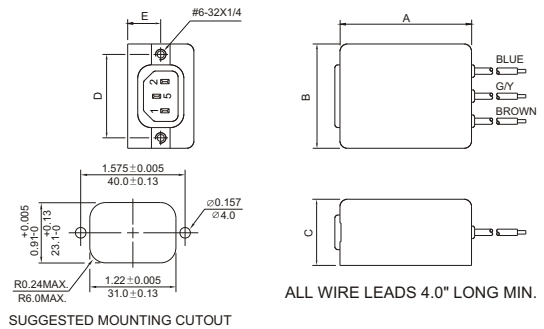

UNIT: INCH
mm

MECHANICAL CONSTRUCTION

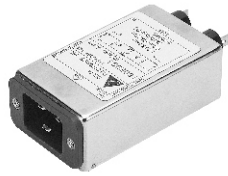

DG3

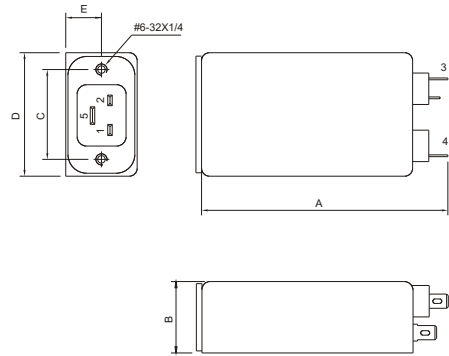

DG3S

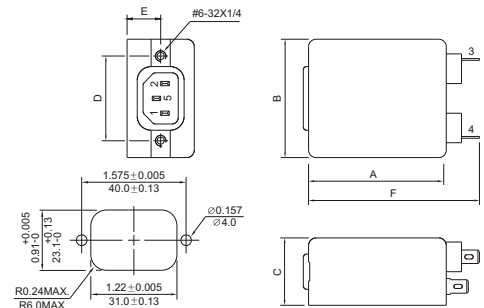

SUGGESTED MOUNTING CUTOUT

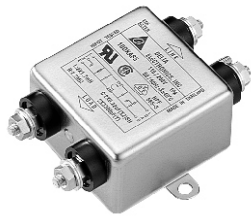

AS5

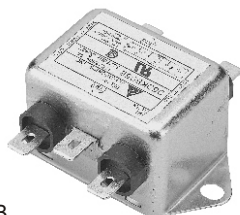
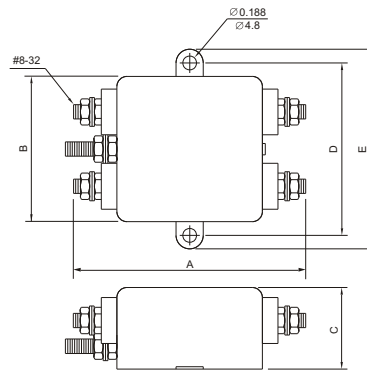

BG5B, BW5B
(option wire style)

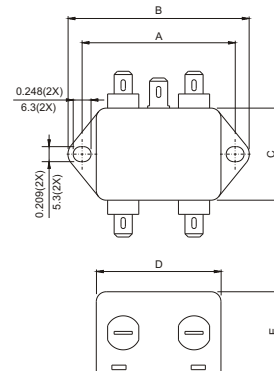

MECHANICAL CONSTRUCTION

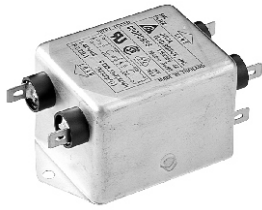

CG5B

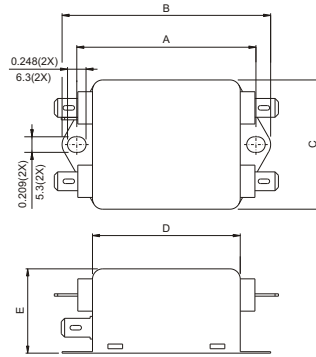

CW5B

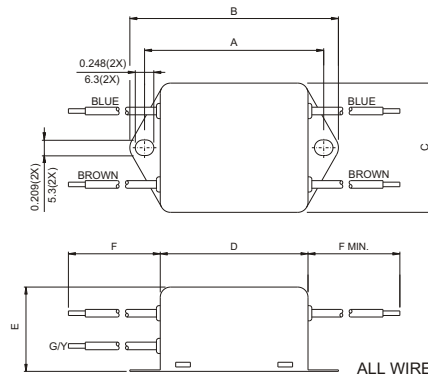

CS5B

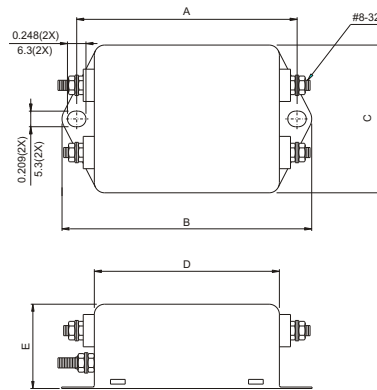

UNIT: $\frac{\text{INCH}}{\text{mm}}$



Компания «ЭлектроПласт» предлагает заключение долгосрочных отношений при поставках импортных электронных компонентов на взаимовыгодных условиях!

Наши преимущества:

- Оперативные поставки широкого спектра электронных компонентов отечественного и импортного производства напрямую от производителей и с крупнейших мировых складов;
- Поставка более 17-ти миллионов наименований электронных компонентов;
- Поставка сложных, дефицитных, либо снятых с производства позиций;
- Оперативные сроки поставки под заказ (от 5 рабочих дней);
- Экспресс доставка в любую точку России;
- Техническая поддержка проекта, помощь в подборе аналогов, поставка прототипов;
- Система менеджмента качества сертифицирована по Международному стандарту ISO 9001;
- Лицензия ФСБ на осуществление работ с использованием сведений, составляющих государственную тайну;
- Поставка специализированных компонентов (Xilinx, Altera, Analog Devices, Intersil, Interpoint, Microsemi, Aeroflex, Peregrine, Syfer, Eurofarad, Texas Instrument, Miteq, Cobham, E2V, MA-COM, Hittite, Mini-Circuits, General Dynamics и др.);

Помимо этого, одним из направлений компании «ЭлектроПласт» является направление «Источники питания». Мы предлагаем Вам помощь Конструкторского отдела:

- Подбор оптимального решения, техническое обоснование при выборе компонента;
- Подбор аналогов;
- Консультации по применению компонента;
- Поставка образцов и прототипов;
- Техническая поддержка проекта;
- Защита от снятия компонента с производства.



Как с нами связаться

Телефон: 8 (812) 309 58 32 (многоканальный)

Факс: 8 (812) 320-02-42

Электронная почта: org@eplast1.ru

Адрес: 198099, г. Санкт-Петербург, ул. Калинина, дом 2, корпус 4, литера А.