

## 31 A, 600 V, very fast IGBT with Ultrafast diode

### Features

- Low on-voltage drop ( $V_{CE(sat)}$ )
- Very soft Ultrafast recovery anti-parallel diode

### Applications

- High frequency motor drives
- SMPS and PFC in both hard switch and resonant topologies

### Description

This device is an ultrafast IGBT. It utilizes the advanced Power MESH™ process resulting in an excellent trade-off between switching performance and low on-state behavior.

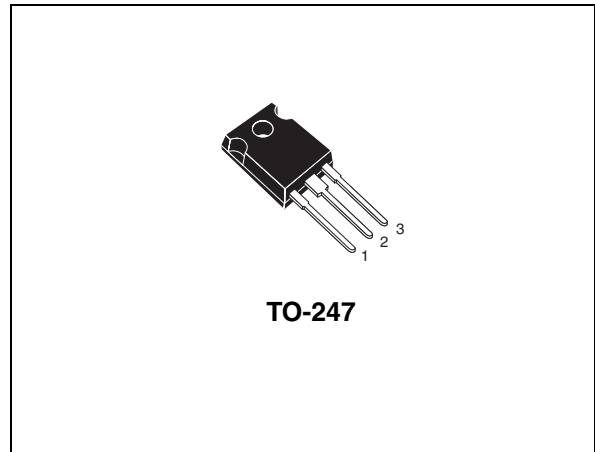

**Figure 1. Internal schematic diagram**

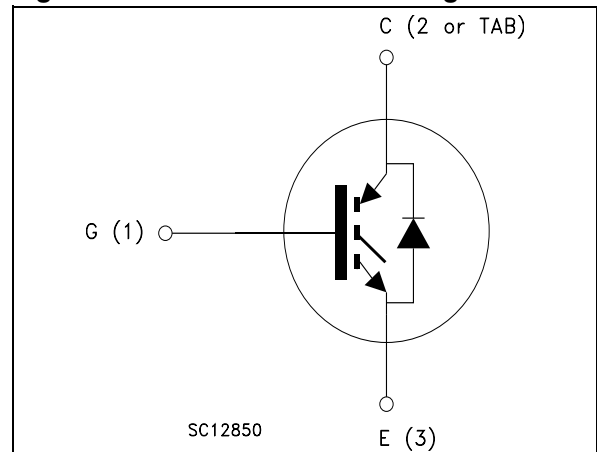

**Table 1. Device summary**

Part number	Marking	Package	Packaging
STGWA19NC60HD	GWA19NC60HD	TO-247 long leads	Tube

# Contents

<b>1</b>	<b>Electrical ratings</b> .....	<b>3</b>
<b>2</b>	<b>Electrical characteristics</b> .....	<b>4</b>
	2.1 Electrical characteristics (curves) .....	6
<b>3</b>	<b>Test circuits</b> .....	<b>9</b>
<b>4</b>	<b>Package mechanical data</b> .....	<b>10</b>
<b>5</b>	<b>Revision history</b> .....	<b>13</b>

# 1 Electrical ratings

**Table 2. Absolute maximum ratings**

Symbol	Parameter	Value	Unit
$V_{CES}$	Collector-emitter voltage ( $V_{GE} = 0$ )	600	V
$I_C^{(1)}$	Continuous collector current at $T_C = 25\text{ °C}$	52	A
$I_C^{(1)}$	Continuous collector current at $T_C = 100\text{ °C}$	31	A
$I_{CL}^{(2)}$	Turn-off latching current	40	A
$I_{CP}^{(3)}$	Pulsed collector current	60	A
$I_F$	Diode RMS forward current at $T_C = 25\text{ °C}$	20	A
$I_{FSM}$	Surge not repetitive forward current $t_p=10\text{ ms}$ sinusoidal	50	A
$V_{GE}$	Gate-emitter voltage	$\pm 20$	V
$P_{TOT}$	Total dissipation at $T_C = 25\text{ °C}$	208	W
$T_J$	Operating junction temperature	- 55 to 150	$^{\circ}\text{C}$

1. Calculated according to the iterative formula:

$$I_C(T_C) = \frac{T_{j(\max)} - T_C}{R_{thj-c} \times V_{CE(sat)(\max)}(T_{j(\max)}, I_C(T_C))}$$

2.  $V_{clamp} = 80\%V_{CES}$ ,  $T_J = 150\text{ °C}$ ,  $R_G = 10\ \Omega$ ,  $V_{GE} = 15\text{ V}$

3. Pulse width limited by maximum permissible junction temperature and turn-off within RBSOA

**Table 3. Thermal data**

Symbol	Parameter	Value	Unit
$R_{thJC}$	Thermal resistance junction-case IGBT	0.6	$^{\circ}\text{C/W}$
	Thermal resistance junction-case diode	3	$^{\circ}\text{C/W}$
$R_{thJA}$	Thermal resistance junction-ambient	50	$^{\circ}\text{C/W}$

## 2 Electrical characteristics

$T_J = 25\text{ °C}$  unless otherwise specified)

**Table 4. Static**

Symbol	Parameter	Test conditions	Min.	Typ.	Max.	Unit
$V_{(BR)CES}$	Collector-emitter breakdown voltage ( $V_{GE} = 0$ )	$I_C = 1\text{ mA}$	600			V
$V_{CE(sat)}$	Collector-emitter saturation voltage	$V_{GE} = 15\text{ V}, I_C = 12\text{ A}$ $V_{GE} = 15\text{ V}, I_C = 15\text{ A}$ $V_{GE} = 15\text{ V}, I_C = 30\text{ A}, T_J = 100\text{ °C}$ $V_{GE} = 15\text{ V}, I_C = 12\text{ A}, T_J = 125\text{ °C}$		1.8 2 2.5 1.6	2.5	V
$V_{GE(th)}$	Gate threshold voltage	$V_{CE} = V_{GE}, I_C = 250\text{ }\mu\text{A}$	3.75		5.75	V
$I_{CES}$	Collector cut-off current ( $V_{GE} = 0$ )	$V_{CE} = 600\text{ V}$ $V_{CE} = 600\text{ V}, T_J = 125\text{ °C}$			150 1	$\mu\text{A}$ mA
$I_{GES}$	Gate-emitter leakage current ( $V_{CE} = 0$ )	$V_{GE} = \pm 20\text{ V}$			$\pm 100$	nA
$g_{fs}^{(1)}$	Forward transconductance	$V_{CE} = 15\text{ V}, I_C = 12\text{ A}$		5		S

1. Pulsed: pulse duration = 300  $\mu\text{s}$ , duty cycle 1.5%

**Table 5. Dynamic**

Symbol	Parameter	Test conditions	Min.	Typ.	Max.	Unit
$C_{ies}$	Input capacitance			1180		pF
$C_{oes}$	Output capacitance	$V_{CE} = 25\text{ V}, f = 1\text{ MHz},$	-	130	-	pF
$C_{res}$	Reverse transfer capacitance	$V_{GE} = 0$		36		pF
$Q_g$	Total gate charge	$V_{CE} = 390\text{ V}, I_C = 5\text{ A},$		53		nC
$Q_{ge}$	Gate-emitter charge	$V_{GE} = 15\text{ V},$	-	10	-	nC
$Q_{gc}$	Gate-collector charge	<a href="#">Figure 18</a>		23		nC

**Table 6. Switching on/off (inductive load)**

Symbol	Parameter	Test conditions	Min.	Typ.	Max.	Unit
$t_{d(on)}$ $t_r$ $(di/dt)_{on}$	Turn-on delay time Current rise time Turn-on current slope	$V_{CC} = 390\text{ V}$ , $I_C = 12\text{ A}$ $R_G = 10\ \Omega$ , $V_{GE} = 15\text{ V}$ , <i>Figure 19</i>	-	25 7 1600	-	ns ns A/ $\mu$ s
$t_{d(on)}$ $t_r$ $(di/dt)_{on}$	Turn-on delay time Current rise time Turn-on current slope	$V_{CC} = 390\text{ V}$ , $I_C = 12\text{ A}$ $R_G = 10\ \Omega$ , $V_{GE} = 15\text{ V}$ , $T_J = 125\text{ }^\circ\text{C}$ <i>Figure 19</i>	-	24 8 1400	-	ns ns A/ $\mu$ s
$t_{r(Voff)}$ $t_{d(Voff)}$ $t_f$	Off voltage rise time Turn-off delay time Current fall time	$V_{CC} = 390\text{ V}$ , $I_C = 12\text{ A}$ $R_G = 10\ \Omega$ , $V_{GE} = 15\text{ V}$ , <i>Figure 19</i>	-	27 97 73	-	ns ns ns
$t_{r(Voff)}$ $t_{d(Voff)}$ $t_f$	Off voltage rise time Turn-off delay time Current fall time	$V_{CC} = 390\text{ V}$ , $I_C = 12\text{ A}$ $R_G = 10\ \Omega$ , $V_{GE} = 15\text{ V}$ , $T_J = 125\text{ }^\circ\text{C}$ <i>Figure 19</i>	-	58 144 128	-	ns ns ns

**Table 7. Switching energy (inductive load)**

Symbol	Parameter	Test conditions	Min.	Typ.	Max.	Unit
$E_{on}$ $E_{off}^{(1)}$ $E_{ts}$	Turn-on switching losses Turn-off switching losses Total switching losses	$V_{CC} = 390\text{ V}$ , $I_C = 12\text{ A}$ $R_G = 10\ \Omega$ , $V_{GE} = 15\text{ V}$ , <i>Figure 19</i>	-	85 189 274	-	$\mu$ J $\mu$ J $\mu$ J
$E_{on}$ $E_{off}^{(1)}$ $E_{ts}$	Turn-on switching losses Turn-off switching losses Total switching losses	$V_{CC} = 390\text{ V}$ , $I_C = 12\text{ A}$ $R_G = 10\ \Omega$ , $V_{GE} = 15\text{ V}$ , $T_J = 125\text{ }^\circ\text{C}$ <i>Figure 19</i>	-	187 407 594	-	$\mu$ J $\mu$ J $\mu$ J

1. Turn-off losses include also the tail of the collector current

**Table 8. Collector-emitter diode**

Symbol	Parameter	Test conditions	Min.	Typ.	Max.	Unit
$V_F$	Forward on-voltage	$I_F = 12\text{ A}$ $I_F = 12\text{ A}$ , $T_J = 125\text{ }^\circ\text{C}$	-	2.6 2.1	-	V V
$t_{rr}$ $Q_{rr}$ $I_{rrm}$	Reverse recovery time Reverse recovery charge Reverse recovery current	$I_F = 12\text{ A}$ , $V_R = 40\text{ V}$ , $di/dt = 100\text{ A}/\mu\text{s}$ <i>Figure 20</i>	-	31 30 2	-	ns nC A
$t_{rr}$ $Q_{rr}$ $I_{rrm}$	Reverse recovery time Reverse recovery charge Reverse recovery current	$I_F = 12\text{ A}$ , $V_R = 40\text{ V}$ , $T_J = 125\text{ }^\circ\text{C}$ , $di/dt = 100\text{ A}/\mu\text{s}$ <i>Figure 20</i>	-	59 102 4	-	ns nC A

## 2.1 Electrical characteristics (curves)

Figure 2. Output characteristics

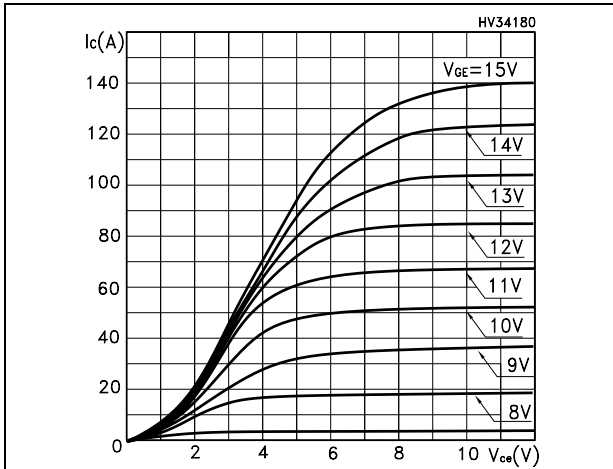

Figure 3. Transfer characteristics

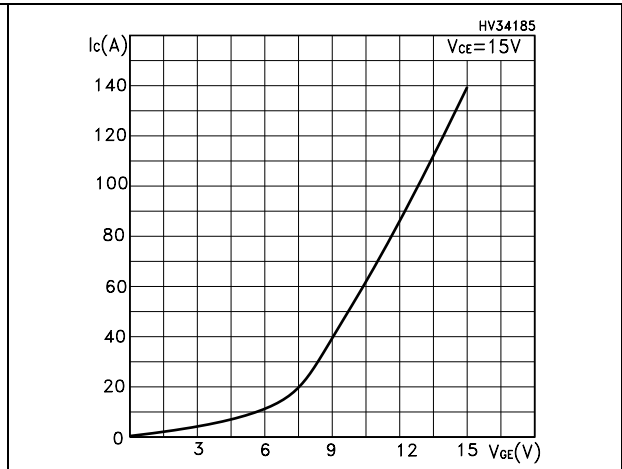

Figure 4. Transconductance

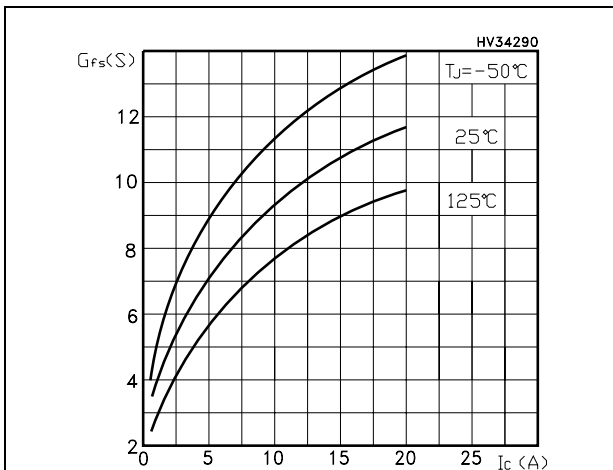

Figure 5. Collector-emitter on voltage vs. temperature

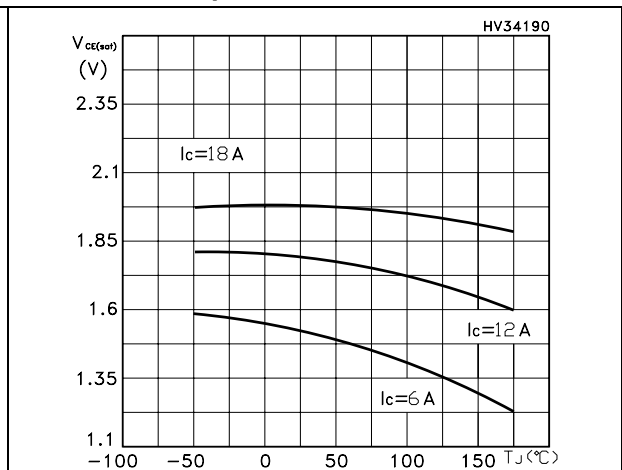

Figure 6. Gate charge vs. gate-source voltage

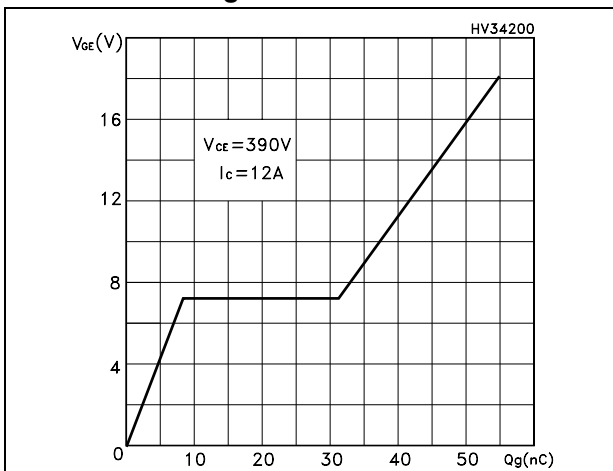
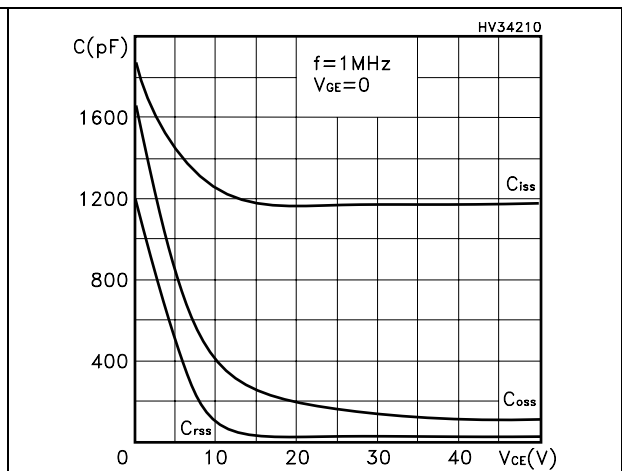
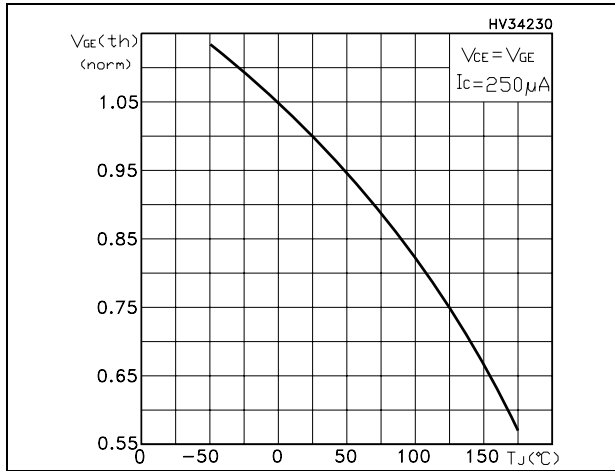

Figure 7. Capacitance variations



**Figure 8. Normalized gate threshold voltage vs. temperature**



**Figure 9. Collector-emitter on voltage vs. collector current**

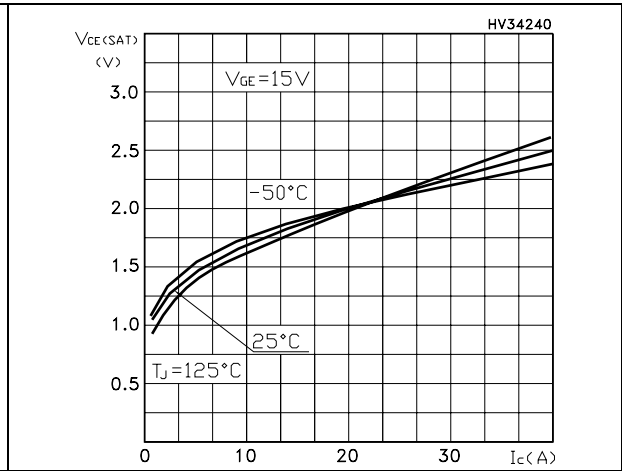

**Figure 10. Normalized breakdown voltage vs. temperature**

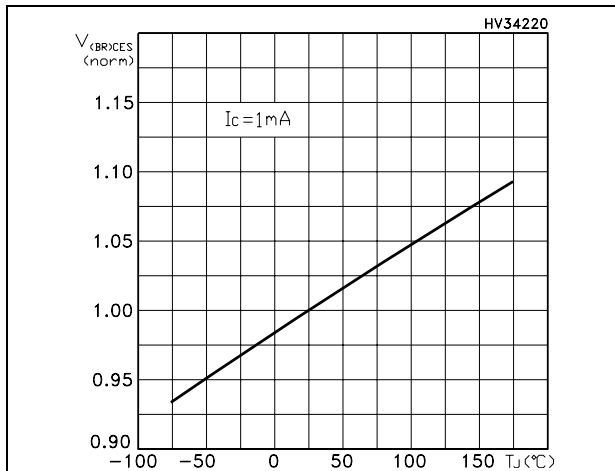

**Figure 11. Switching losses vs. temperature**

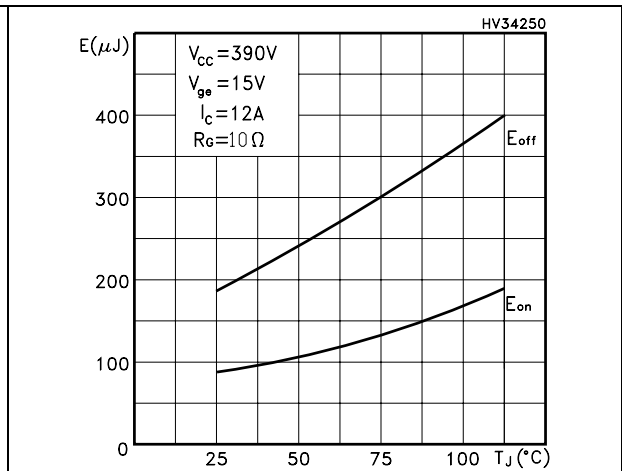

**Figure 12. Switching losses vs. gate resistance**

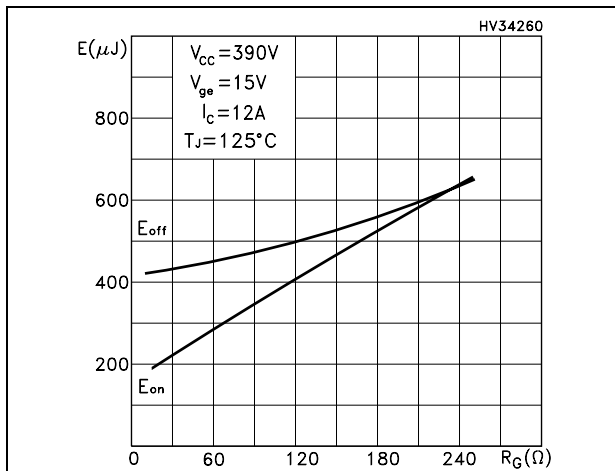

**Figure 13. Switching losses vs. collector current**

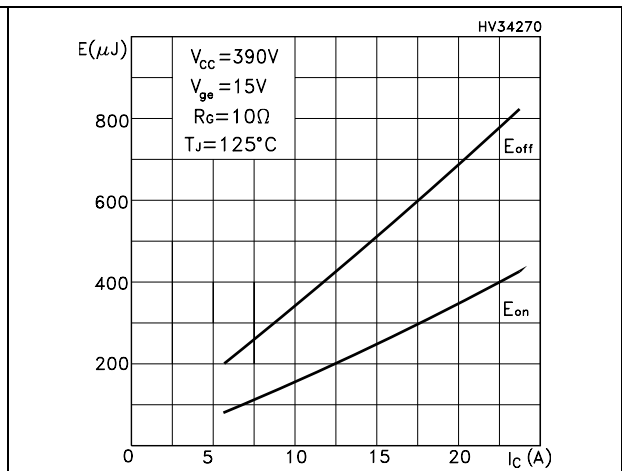

Figure 14. Turn-off SOA

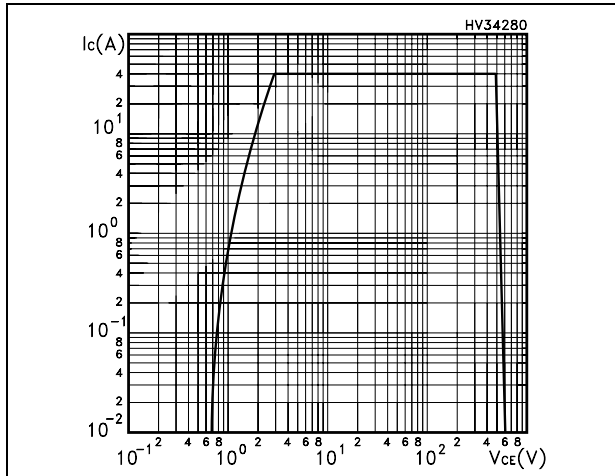

Figure 15. Thermal impedance

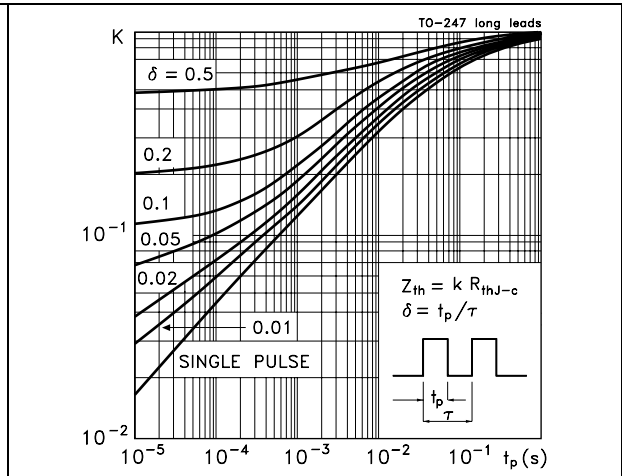
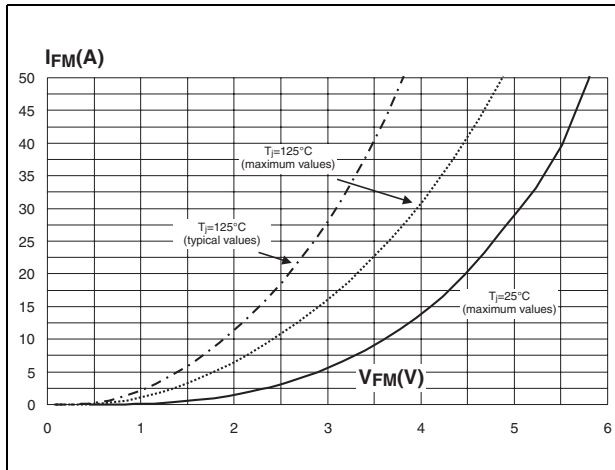

Figure 16. Forward voltage drop vs. forward current





### 3 Test circuits

Figure 17. Test circuit for inductive load switching

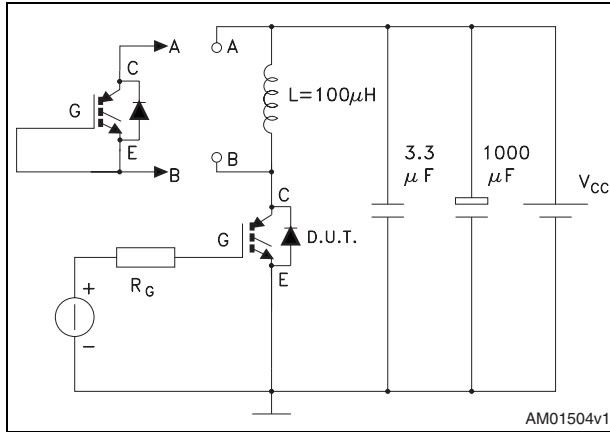

Figure 18. Gate charge test circuit

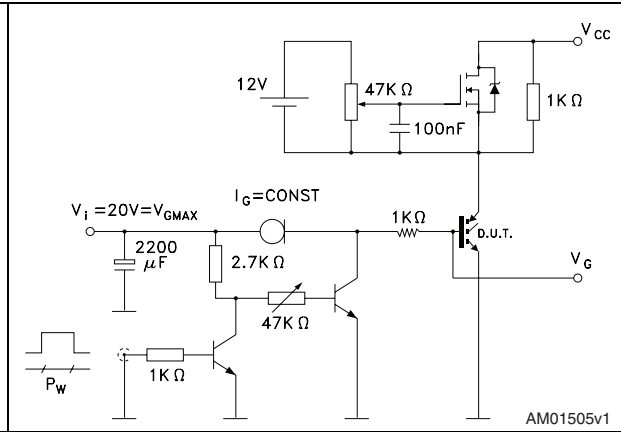

Figure 19. Switching waveform

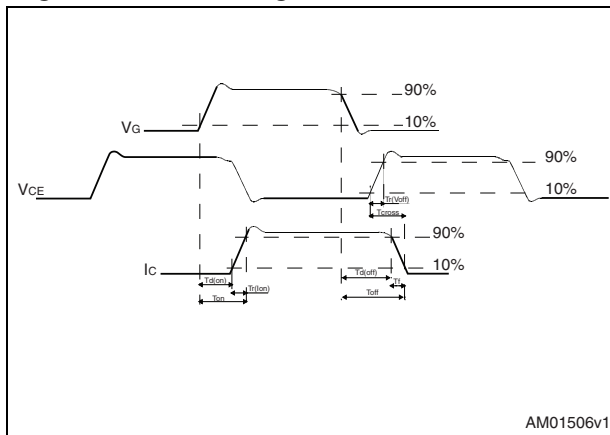
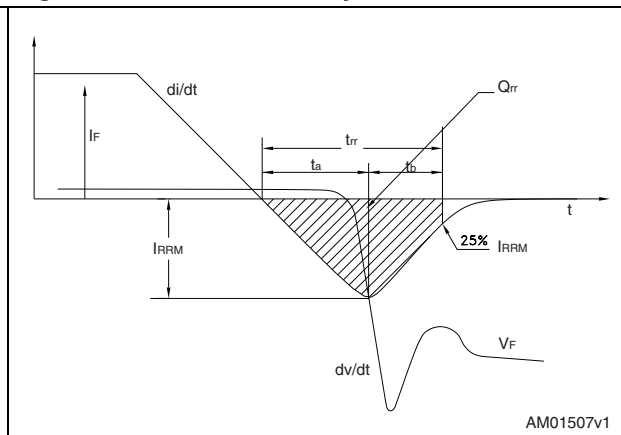

Figure 20. Diode recovery time waveform



## 4 Package mechanical data

In order to meet environmental requirements, ST offers these devices in different grades of ECOPACK® packages, depending on their level of environmental compliance. ECOPACK® specifications, grade definitions and product status are available at: [www.st.com](http://www.st.com). ECOPACK is an ST trademark.

Table 9. TO-247 long leads mechanical data

Dim.	mm.		
	Min.	Typ.	Max.
A	4.90		5.15
D	1.85		2.10
E	0.55		0.67
F	1.07		1.32
F1	1.90		2.38
F2	2.87		3.38
G	10.90 BSC		
H	15.77		16.02
L	20.82		21.07
L1	4.16		4.47
L2	5.49		5.74
L3	20.05		20.30
L4	3.68		3.93
L5	6.04		6.29
M	2.27		2.52
V		10°	
V1		3°	
V3		20°	
Dia.	3.55		3.66

Figure 21. TO-247 long leads drawing

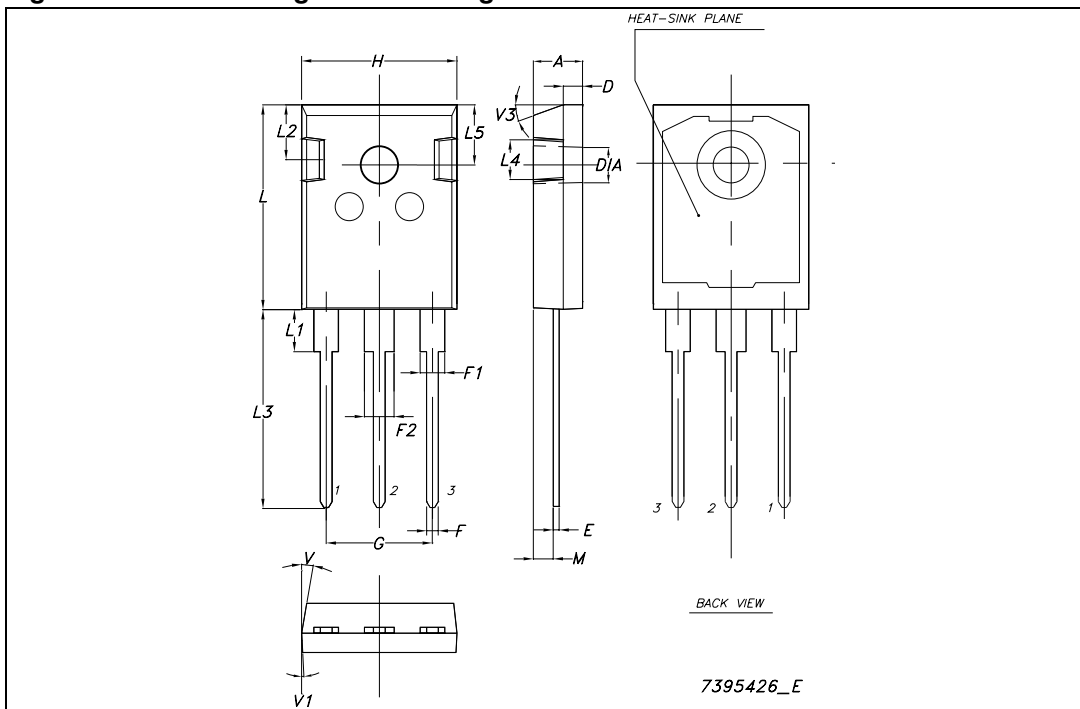

## 5 Revision history

**Table 10. Document revision history**

Date	Revision	Changes
14-Sep-2011	1	Initial release.

**Please Read Carefully:**

Information in this document is provided solely in connection with ST products. STMicroelectronics NV and its subsidiaries ("ST") reserve the right to make changes, corrections, modifications or improvements, to this document, and the products and services described herein at any time, without notice.

All ST products are sold pursuant to ST's terms and conditions of sale.

Purchasers are solely responsible for the choice, selection and use of the ST products and services described herein, and ST assumes no liability whatsoever relating to the choice, selection or use of the ST products and services described herein.

No license, express or implied, by estoppel or otherwise, to any intellectual property rights is granted under this document. If any part of this document refers to any third party products or services it shall not be deemed a license grant by ST for the use of such third party products or services, or any intellectual property contained therein or considered as a warranty covering the use in any manner whatsoever of such third party products or services or any intellectual property contained therein.

**UNLESS OTHERWISE SET FORTH IN ST'S TERMS AND CONDITIONS OF SALE ST DISCLAIMS ANY EXPRESS OR IMPLIED WARRANTY WITH RESPECT TO THE USE AND/OR SALE OF ST PRODUCTS INCLUDING WITHOUT LIMITATION IMPLIED WARRANTIES OF MERCHANTABILITY, FITNESS FOR A PARTICULAR PURPOSE (AND THEIR EQUIVALENTS UNDER THE LAWS OF ANY JURISDICTION), OR INFRINGEMENT OF ANY PATENT, COPYRIGHT OR OTHER INTELLECTUAL PROPERTY RIGHT.**

**UNLESS EXPRESSLY APPROVED IN WRITING BY TWO AUTHORIZED ST REPRESENTATIVES, ST PRODUCTS ARE NOT RECOMMENDED, AUTHORIZED OR WARRANTED FOR USE IN MILITARY, AIR CRAFT, SPACE, LIFE SAVING, OR LIFE SUSTAINING APPLICATIONS, NOR IN PRODUCTS OR SYSTEMS WHERE FAILURE OR MALFUNCTION MAY RESULT IN PERSONAL INJURY, DEATH, OR SEVERE PROPERTY OR ENVIRONMENTAL DAMAGE. ST PRODUCTS WHICH ARE NOT SPECIFIED AS "AUTOMOTIVE GRADE" MAY ONLY BE USED IN AUTOMOTIVE APPLICATIONS AT USER'S OWN RISK.**

Resale of ST products with provisions different from the statements and/or technical features set forth in this document shall immediately void any warranty granted by ST for the ST product or service described herein and shall not create or extend in any manner whatsoever, any liability of ST.

ST and the ST logo are trademarks or registered trademarks of ST in various countries.

Information in this document supersedes and replaces all information previously supplied.

The ST logo is a registered trademark of STMicroelectronics. All other names are the property of their respective owners.

© 2011 STMicroelectronics - All rights reserved

STMicroelectronics group of companies

Australia - Belgium - Brazil - Canada - China - Czech Republic - Finland - France - Germany - Hong Kong - India - Israel - Italy - Japan - Malaysia - Malta - Morocco - Philippines - Singapore - Spain - Sweden - Switzerland - United Kingdom - United States of America

[www.st.com](http://www.st.com)



Компания «ЭлектроПласт» предлагает заключение долгосрочных отношений при поставках импортных электронных компонентов на взаимовыгодных условиях!

Наши преимущества:

- Оперативные поставки широкого спектра электронных компонентов отечественного и импортного производства напрямую от производителей и с крупнейших мировых складов;
- Поставка более 17-ти миллионов наименований электронных компонентов;
- Поставка сложных, дефицитных, либо снятых с производства позиций;
- Оперативные сроки поставки под заказ (от 5 рабочих дней);
- Экспресс доставка в любую точку России;
- Техническая поддержка проекта, помощь в подборе аналогов, поставка прототипов;
- Система менеджмента качества сертифицирована по Международному стандарту ISO 9001;
- Лицензия ФСБ на осуществление работ с использованием сведений, составляющих государственную тайну;
- Поставка специализированных компонентов (Xilinx, Altera, Analog Devices, Intersil, Interpoint, Microsemi, Aeroflex, Peregrine, Syfer, Eurofarad, Texas Instrument, Miteq, Cobham, E2V, MA-COM, Hittite, Mini-Circuits, General Dynamics и др.);

Помимо этого, одним из направлений компании «ЭлектроПласт» является направление «Источники питания». Мы предлагаем Вам помощь Конструкторского отдела:

- Подбор оптимального решения, техническое обоснование при выборе компонента;
- Подбор аналогов;
- Консультации по применению компонента;
- Поставка образцов и прототипов;
- Техническая поддержка проекта;
- Защита от снятия компонента с производства.



#### Как с нами связаться

**Телефон:** 8 (812) 309 58 32 (многоканальный)

**Факс:** 8 (812) 320-02-42

**Электронная почта:** [org@eplast1.ru](mailto:org@eplast1.ru)

**Адрес:** 198099, г. Санкт-Петербург, ул. Калинина, дом 2, корпус 4, литера А.