

Click [here](#) for production status of specific part numbers.

MAX98374

Digital Input Class D Speaker Amplifier with DHT

General Description

The MAX98374 is a high-efficiency, mono Class D speaker amplifier featuring dynamic headroom tracking (DHT) and brownout protection. As the power-supply voltage varies due to sudden transients and declining battery life, DHT automatically optimizes the headroom available to the Class D amplifier to maintain a consistent listening experience. A wide 5.5V to 16V supply range allows the device to exceed 16W into an 8Ω load.

The flexible digital interface supports either the MIPI SoundWire® compatible interface for audio and control data, or the PCM interface for audio data and a standard I²C interface for control data. The PCM interface supports I²S, left-justified, and TDM audio data formats at 16-, 32-, 44.1-, 48-, 88.2-, and 96kHz sample rates with 16-, 24-, and 32-bit data. In TDM mode, the device can support up to 16 channels of audio data. A unique clocking structure eliminates the need for an external master clock for PCM communication, which reduces pin count and simplifies board layout.

Active emissions limiting (AEL), spread spectrum modulation (SSM), and edge rate control minimize EMI and eliminate the need for the output filtering found in traditional Class D devices.

Thermal foldback protection ensures robust behavior when the thermal limits of the device are reached. When enabled, it automatically reduces the output power when the temperature exceeds a user specified threshold. This allows for uninterrupted music playback even at high ambient temperatures. Traditional thermal protection is also available in addition to robust overcurrent protection.

A flexible brownout-detection engine (BDE) can be programmed to initiate various gain reductions, signal limiting, and clip functions based on supply voltage status. Threshold, hysteresis, and attack/release rates are programmable.

The device is available in a 0.4mm pitch, 25-bump wafer-level package (WLP), or in a 0.4mm pitch, 22-pin FCQFN package. The device operates over the extended -40°C to +85°C temperature range.

MIPI SoundWire is a registered trademark of MIPI Alliance, Inc.

Benefits and Features

- Wide Input Supply Range (5.5V to 16V)
- Dynamic Headroom Tracking (DHT) Maintains a Consistent Listening Experience
- Integrated Thermal Protection and Output Foldback
- Remote Output Sensing Allows up to 20dB THD+N Improvement with Ferrite Bead Filters
- Class D EMI Reduction Enables Filterless Operation
 - Active Emissions Limiting (AEL)
 - Spread-Spectrum Modulation (SSM)
 - Switching Edge Rate Control
- 110dB A-Weighted Dynamic Range
- 0.006% THD+N at 3W into 8Ω, f = 1kHz
- 0.025% THD+N at 3W into 8Ω, f = 6kHz
- Output Power at 1% THD+N:
 - 13.5W into 8Ω, V_{PVDD} = 16V
 - 12.5W into 4Ω, V_{PVDD} = 12V
- Output Power at 10% THD+N:
 - 16.9W into 8Ω, V_{PVDD} = 16V
 - 15.3W into 4Ω, V_{PVDD} = 12V
- Speaker Amplifier Efficiency:
 - 90.5% at 10W into 8Ω, V_{PVDD} = 12V
 - 81% at 15.3W into 4Ω, V_{PVDD} = 12V
- BDE Provides Supply Brownout Protection
- Extensive Click-and-Pop Suppression
- Space Saving Packages
 - 25-Bump WLP (2.17mm x 2.25mm x 0.64mm, 0.4mm Pitch)
 - 22-Pin FCQFN (3mm x 3mm x 0.55mm, 0.4mm Pitch)

Applications

- Tablets
- Notebook Computers
- Sound Bars

Ordering Information appears at end of data sheet.

Simplified Block Diagram

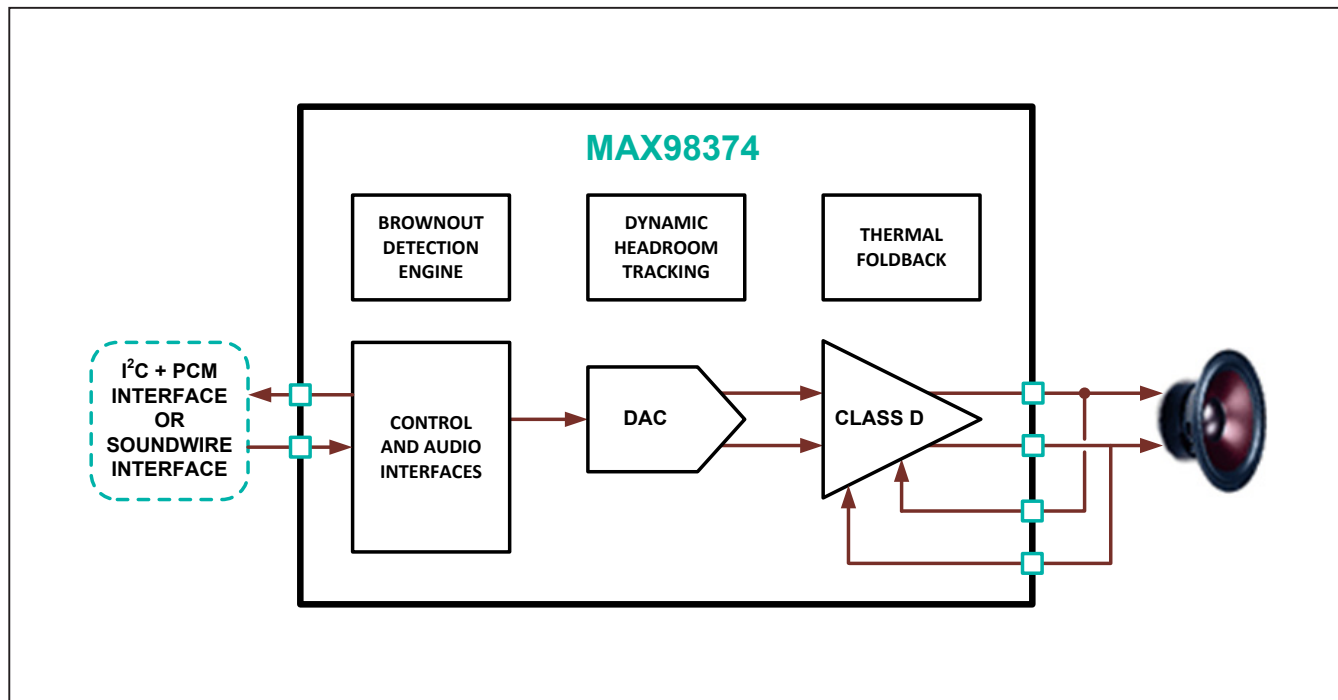

TABLE OF CONTENTS

General Description	1
Benefits and Features	1
Simplified Block Diagram	2
Detailed Block Diagram	11
Absolute Maximum Ratings	12
Package Thermal Characteristics	12
Electrical Characteristics	12
PCM and ICC Interface Timing Characteristics	18
I ² C Interface Timing Characteristics	21
SoundWire Compatible Slave Interface Timing Characteristics	22
Device Reset Timing Characteristics	24
Typical Operating Characteristics	25
Pin Configuration (WLP)	36
Pin Configuration (FCQFN)	37
Pin Description	38
Detailed Description	39
Control Interface Configuration	39
Device Register Map	40
Control Bit Field Types and Write Access Restrictions	48
Device Sequencing	49
Device State Control	50
Hardware Shutdown	50
Software Shutdown	50
Power Supply UVLO	50
Software Reset	50
SoundWire Bus Reset	50
SoundWire Register Reset	50
Global Enable	51
Software Reset	51
I ² C Serial Interface	52
I ² C Slave Address	52
I ² C Slave Interface Operation	52
Bit Transfer	52
START and STOP Conditions	53
Early STOP Conditions	53

TABLE OF CONTENTS (CONTINUED)

Acknowledge	53
I ² C Write Data Format	54
I ² C Read Data Format	55
Audio Interface Mode Configuration	56
PCM Interface	56
PCM Clock Configuration	56
Clock Ratio Configuration	56
PCM Interface Sample Rate	57
Speaker Path Sample Rate	57
PCM Interface Clock Ratio Configuration	58
PCM Data Format Configuration	58
I ² S and Left-Justified Mode	58
TDM Modes	60
PCM Interface Data Format Configuration	62
PCM Data Path Configuration	63
PCM Data Input	63
PCM Interface Data Input (DIN) Enable	64
PCM Interface Digital Mono Mixer Configuration 1	64
PCM Data Output	65
PCM Interface Digital Mono Mixer Configuration 2	65
PCM Interface Data Output (DOUT) Enable	66
PCM Interface Data Output Speaker DSP Feedback Channel Source	66
PCM Interface Data Output Channel Configuration 1	67
PCM Interface Data Output Channel Configuration 2	68
SoundWire Slave Interface	69
SoundWire Slave Device Identification and Addressing	69
SoundWire Input Clock Configuration	70
SoundWire Clock Configuration	70
SoundWire Slave Control Port (SCP) Configuration	71
SoundWire Device Data Port (DP) Configuration	71
IRQ Bus Configuration	72
Interrupts	72

TABLE OF CONTENTS (CONTINUED)

Interrupt Bit Field Composition	72
Raw Status (RAW)	72
State (STATE)	72
Flag (FLAG)	72
Enable (EN)	72
Clear (CLR)	72
IRQ Output Configuration	72
Interrupt Sources	72
Device Interrupt Sources	73
Digital Output Pin Drive Strength Configuration	74
Digital Output Pin Drive Strength	74
Tone Generator	75
Tone Generator Configuration	75
Speaker Path Configuration	76
Speaker Path Dither	76
Speaker Path Data Inversion	76
Speaker Path DC Blocking Filter	76
Speaker Path Digital Volume Control	76
Speaker Path Digital Gain Control	77
Speaker Path DSP Data Feedback Path	77
Speaker Path Maximum Peak Output-Voltage Scaling	77
Speaker Path DSP Configuration	78
Speaker Path Digital Volume Control	79
Speaker Path Output Level Scaling	79
Class D Speaker Amplifier Output Stage	80
Speaker Amplifier Clock Synchronization	80
Speaker Amplifier Ultra-Low EMI Filterless Operation	80
Speaker Amplifier Current Limit	80
Speaker Path and Speaker DSP Data Feedback Path Enables	81
Speaker Amplifier Switching Edge Rate Configuration	81
Speaker Amplifier Configuration	82

TABLE OF CONTENTS (CONTINUED)

Measurement ADC	82
Measurement ADC Thermal Channel	82
Measurement ADC Thermal Channel	83
Measurement ADC Sample Rate Control	83
Measurement ADC Thermal Channel Readback	83
Measurement ADC Thermal Channel Filter Configuration	84
Measurement ADC PVDD Channel	84
Measurement ADC PVDD Channel Readback	85
Measurement ADC PVDD Channel Filter Configuration	85
Measurement ADC PVDD Channel Enable	86
Clock Monitor	86
Clock Monitor in SoundWire Control Mode	86
Device Auto-Restart Configuration	87
Dynamic Headroom Tracking (DHT)	88
DHT Modes of Operation	88
MODE 1: V_{PVDD} is greater than V_{MPO}	88
MODE 2: V_{PVDD} is less than V_{MPO} and greater than V_{RP}	89
MODE 3a: V_{PVDD} is less than V_{RP} and greater than V_{MIN}	89
MODE 3b: V_{PVDD} is less than V_{MIN} and greater than V_{RP}	91
DHT Enable	92
DHT Ballistics	93
DHT Configuration	93
DHT Headroom Calculation	94
DHT Attack Rate Settings	95
DHT Release Rate Settings	95
Limiter	96
Limiter Enable	97
Limiter Threshold Configuration	97
Limiter Attack and Release Rate Configuration	98
Brownout-Detection Engine (BDE)	99
BDE State Controller and Level Thresholds	99
BDE Level Configuration Options	101

TABLE OF CONTENTS (CONTINUED)

BDE Gain Reduction	101
BDE Limiter Function	102
BDE Clipper Function	102
BDE Current State	103
BDE Level Hold Time	104
BDE Enable	104
BDE Level 1 Threshold	104
BDE Level 2 Threshold	105
BDE Level 3 Threshold	105
BDE Level 4 Threshold	106
BDE Level Threshold Hysteresis	106
BDE Gain Reduction Attack/Release Rates	107
BDE Clipper Mode	108
BDE Level 1 Limiter Configuration	108
BDE Level 1 Clipper Configuration	109
BDE Level 1 Gain Reduction Configuration	109
BDE Level 2 Limiter Configuration	110
BDE Level 2 Clipper Configuration	110
BDE Level 2 Gain Reduction Configuration	111
BDE Level 3 Limiter Configuration	111
BDE Level 3 Clipper Configuration	112
BDE Level 3 Gain Reduction Configuration	112
BDE Level 4 Limiter Configuration	113
BDE Level 4 Clipper and State Configuration	113
BDE Level 4 Gain Reduction Configuration	114
BDE Level 4 Infinite Hold Clear	114
Thermal Protection	115
Thermal Warning and Shutdown Threshold Configuration	115

TABLE OF CONTENTS (CONTINUED)

Thermal-Warning Threshold Configuration	115
Thermal-Shutdown Threshold Configuration	115
Thermal Hysteresis Configuration	116
Thermal Shutdown Recovery Configuration	116
Thermal Foldback Configuration	116
Thermal-Foldback Settings	117
Thermal-Foldback Enable	117
ICC Interface	118
ICC Interface Data Format	118
ICC Interface Device Group Assignment	118
ICC Data Transmit and Receive	118
ICC Interface Group Data Synchronization	119
ICC Interface Link Synchronization	119
ICC Data Link Configuration	121
ICC Receiver Enables 1	122
ICC Receiver Enables 2	123
ICC Transmitter Configuration	123
ICC Transmitter Channel Configuration 1	124
ICC Transmitter Channel Configuration 2	125
ICC Transmitter Enable	125
Layout and Grounding	126
WLP Applications Information	126
Typical Application Circuit	127
Device Revision Identification Number	128
Ordering Information	128
Chip Information	128
Package Information	128
Revision Identification Number	128
Revision History	129

LIST OF FIGURES

Figure 1. I ² S Audio Interface Timing Diagram	20
Figure 2. Left-Justified Audio Interface Timing Diagram	20
Figure 3. TDM Interface Timing Diagram	20
Figure 4: PCM Data Output Timing (DOUT)	20
Figure 5. I ² C Timing	21
Figure 6. SoundWire Data Input Timing Diagram	22
Figure 7. SoundWire Data Output Timing Diagram	23
Figure 8. $\overline{\text{RESET}}$ Timing Diagram	24
Figure 9. Control Interface Configuration Options	39
Figure 10. START, STOP, and REPEATED START Conditions	53
Figure 11. Acknowledge	53
Figure 12. Writing One Byte of Data to the Slave	54
Figure 13. Writing n-Bytes of Data to the Slave	54
Figure 14. Reading One Byte of Data from the Slave	55
Figure 15. Reading n-Bytes of Data from the Slave	55
Figure 16. Standard I ² S Mode Data Format Example (16-Bit Data Word, 24-Bit Channel Length)	59
Figure 17. Left-Justified Mode Data Format Examples (16-Bit Data Word, 24-Bit Channel Length)	59
Figure 18. TDM Mode Data Format Examples (4 Channels, 32-Bit Data Word and Channel Length).	61
Figure 19. Device Signal Path Diagram.	63
Figure 20. Digital Monomix Control	63
Figure 21. Internal Clock Generation in SoundWire Control Mode	70
Figure 22. Speaker Path Block Diagram	76
Figure 23. Filterless EMI results for EN 55022 Class B Standard	80
Figure 24. Output EMI results for EN 55022 Class B Standard	80
Figure 25. Example of DHT in Mode 1 Operation	88
Figure 26. Example of DHT in Mode 2 Operation with $V_{RP} \geq V_{MIN}$	89
Figure 27. Example of DHT in Mode 2 Operation with $V_{RP} < V_{MIN}$	90
Figure 28. Example of DHT in Mode 3a Operation (Limiter Disabled)	90
Figure 29. Example of DHT in Mode 3b Operation (Limiter Disabled)	91
Figure 30. Example of Dynamic Headroom Tracking in Mode 3b Operation (Limiter Enabled).	92
Figure 31. DHT Attack Functionality	94
Figure 32. Example of Limiter Operation with the BDE Inactive	96
Figure 33. BDE Block Diagram	99
Figure 34. BDE Level State Transitions.	100
Figure 35. Gain Reduction Profile Example with -6dB Setting	101

LIST OF FIGURES (CONTINUED)

Figure 36. Limiter Profile Example with -6dBFS Knee Level	102
Figure 37. Clipper Example with -6dBFS Threshold	103
Figure 38. ICC Data Structure	118
Figure 39. ICC Bus Data Structure	118
Figure 40. ICC Bus Round-Robin Data Sequence	119

LIST OF TABLES

Table 1. Register Map Bit Field Color Coding	40
Table 2. General Control Register Map	41
Table 3. SoundWire Slave Interface Register Map	46
Table 4. Bit Types, Subtypes, and Write Access Restrictions	48
Table 5. Typical Full Power-Up Sequence	49
Table 6. Typical Full Shutdown Sequence	49
Table 7. Configuring the I ² C Slave Address	52
Table 8. Supported I ² S/Left-Justified Mode Configurations	58
Table 9. Supported TDM Mode Configurations	60
Table 10. Control Registers and the DOUT Pin	65
Table 11. SoundWire Slave Device Identification	69
Table 12. SoundWire Slave Device Unique ID Configuration	69
Table 13. SoundWire Slave Control Port (SCP) Options	71
Table 14. SoundWire Slave Interface Data Port Assignments	71
Table 15. Data Port 1 and 3 Options	71
Table 16. Maximum Peak Output-Voltage Scaling Configuration	77
Table 17. BDE Operating Levels	99
Table 18. Example of BDE Settings	101
Table 19. ICC Tag Decode Values	118
Table 20. Register Settings that Must Match Across an ICC Group	120
Table 21. Recommended External Components	126
Table 22. Unused Connections	126

Detailed Block Diagram

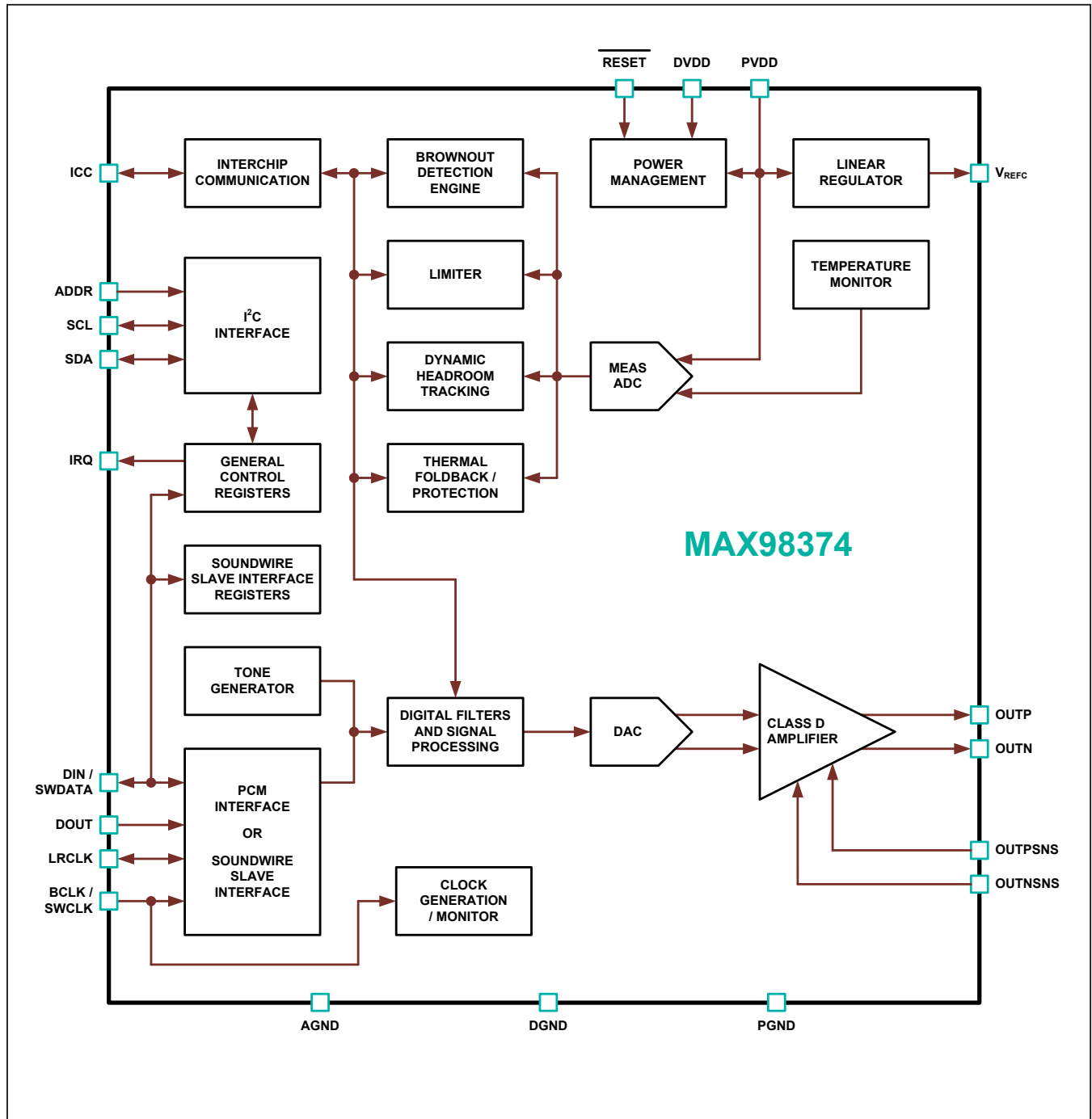

Absolute Maximum Ratings

PVDD to PGND	-0.3V to +18V
AGND, DGND to PGND	-0.1V to +0.1V
DVDD to DGND	-0.3V to +2.15V
OUTP, OUTN to PGND	-0.3V to $V_{PVDD} + 0.3V$
OUTPSNS, OUTNSNS to PGND	-0.3V to +18V
VREFC to AGND	-0.3V to +5.5V
SDA, SCL, ADDR to DGND	-0.3V to +5.5V
All other digital pins to DGND	-0.3V to $V_{DVDD} + 0.3V$
Short-Circuit Duration Between OUTP, OUTN, and PVDD or PGND	Continuous
Short-Circuit Duration Between OUTP and OUTN	Continuous

Continuous Power Dissipation ($T_A = +70^\circ C$) for Multilayer Board (derate 19.07mW/ $^\circ C$ above +70 $^\circ C$, WLP).....	1.53 W
Continuous Power Dissipation ($T_A = +70^\circ C$) for Multilayer Board (derate 25mW/ $^\circ C$ above +70 $^\circ C$, FCQFN).....	2.0 W
Junction Temperature.....	+150 $^\circ C$
Operating Temperature Range.....	-40 $^\circ C$ to +85 $^\circ C$
Storage Temperature Range.....	-65 $^\circ C$ to +150 $^\circ C$
Soldering Temperature (reflow).....	+260 $^\circ C$

Stresses beyond those listed under "Absolute Maximum Ratings" may cause permanent damage to the device. These are stress ratings only, and functional operation of the device at these or any other conditions beyond those indicated in the operational sections of the specifications is not implied. Exposure to absolute maximum rating conditions for extended periods may affect device reliability.

Package Thermal Characteristics (Note 1)

WLP

Junction-to-Ambient Thermal Resistance (θ_{JA})+52.43 $^\circ C/W$

FCQFN

Junction-to-Ambient Thermal Resistance (θ_{JA})+40 $^\circ C/W$
 Junction-to-Case Thermal Resistance (θ_{JC}).....+1.5 $^\circ C/W$

Note 1: Package thermal resistances were obtained using the method described in JEDEC specification JESD51-7, using a four-layer board. For detailed information on package thermal considerations, refer to www.maximintegrated.com/thermal-tutorial.

Electrical Characteristics

($V_{PVDD} = 12V$, $V_{DVDD} = 1.8V$, AGND = DGND = PGND = 0V, $C_{PVDD} = 2 \times 10\mu F + 2 \times 0.1\mu F + 1 \times 220\mu F$, $C_{DVDD} = 1\mu F$, $Z_{VREFC} = 10\mu F + 30\Omega$, $Z_{SPK} = \text{Open}$, SPK_GAIN_MAX = 0x7, SPK_FSW_SEL = 0, AC Measurement Bandwidth = 20Hz to 20kHz, PCM Interface, $f_S = 48kHz$, 24-bit data, $T_A = T_{MIN}$ to T_{MAX} unless otherwise noted. Typical values are at $T_A = +25^\circ C$.) (Note 2)

PARAMETER	SYMBOL	CONDITION		MIN	TYP	MAX	UNITS
Power-Supply Voltage Range	V_{PVDD}			5.5		16	V
	V_{DVDD}			1.71		1.89	
PVDD Undervoltage-Lockout	V_{PVDD_UVLO}	V_{PVDD} Falling			4.1		V
DVDD Undervoltage-Lockout	V_{DVDD_UVLO}	V_{DVDD} Falling			1.2		V
Quiescent Current	I_{Q_PVDD}	SPK_FSW_SEL= 0			6.5		mA
		SPK_FSW_SEL= 1			5.5		
Quiescent Current	I_{Q_DVDD}				2.12		mA
Software Shutdown Supply Current	I_{SHDN_SW}	PCM interface inputs pulled low, $T_A = +25^\circ C$	IPVDD			5	μA
			IDVDD			20	
Hardware Shutdown Supply Current	I_{SHDN_HW}	$\overline{RESET} = 0V$, $T_A = +25^\circ C$	IPVDD			5	μA
			IDVDD			1	

Electrical Characteristics (continued)

($V_{PVDD} = 12V$, $V_{DVDD} = 1.8V$, $AGND = DGND = PGND = 0V$, $C_{PVDD} = 2 \times 10\mu F + 2 \times 0.1\mu F + 1 \times 220\mu F$, $C_{DVDD} = 1\mu F$, $Z_{VREFC} = 10\mu F + 30\Omega$, $Z_{SPK} = \text{Open}$, $SPK_GAIN_MAX = 0 \times 7$, $SPK_FSW_SEL = 0$, AC Measurement Bandwidth = 20Hz to 20kHz, PCM Interface, $f_S = 48\text{kHz}$, 24-bit data, $T_A = T_{MIN}$ to T_{MAX} unless otherwise noted. Typical values are at $T_A = +25^\circ\text{C}$.) (Note 2)

PARAMETER	SYMBOL	CONDITION	MIN	TYP	MAX	UNITS
Turn-On Time	t_{ON}	From EN bit set to 1 to full operation	Volume ramping disabled	4.8		ms
			Volume ramping enabled	6.4		
Turn-Off Time	t_{OFF}	From EN bit set to 0 to shutdown	Volume ramping disabled	0.01		ms
			Volume ramping enabled	1.8		
DIGITAL FILTER CHARACTERISTICS ($f_S < 50\text{kHz}$) (Note 4)						
Valid Sample Rates			16		48	kHz
Passband	f_{PLP}	Ripple $< \delta_P$	$0.4535 \times f_S$			Hz
		Droop $< -3\text{dB}$	$0.459 \times f_S$			
Passband Ripple	δ_P	$f < f_{PLP}$, referenced to signal level at 1kHz	-0.1		+0.1	dB
Stopband	f_{SLP}	Attenuation $> \delta_S$			$0.49 \times f_S$	Hz
Stopband Attenuation	δ_S	$f > f_{SLP}$	80			dB
Max Group Delay		$f = 1\text{kHz}$, all sample rates		8		samples
DIGITAL FILTER CHARACTERISTICS ($f_S > 50\text{kHz}$) (Note 4)						
Valid Sample Rates			88.2		96	kHz
Passband	f_{PLP}	Ripple $< \delta_P$	$0.23 \times f_S$			Hz
		Droop $< -3\text{dB}$	$0.31 \times f_S$			
Passband Ripple	δ_P	$f < f_{PLP}$, referenced to signal level at 1kHz	-0.1		+0.1	dB
Stopband	f_{SLP}	Attenuation $> \delta_S$			$0.49 \times f_S$	Hz
Stopband Attenuation	δ_S	$f > f_{SLP}$	80			dB
Group Delay		$f = 1\text{kHz}$, all sample rates		13		samples
DIGITAL HIGHPASS FILTER CHARACTERISTICS (Note 4)						
DC Attenuation			80			dB
DC Blocking Cutoff Frequency		Scales with sample rate		1.872		Hz
DIGITAL VOLUME CONTROL						
Maximum Digital Volume		$SPK_VOL[6:0] = 0 \times 00$		0		dB
Minimum Digital Volume		$SPK_VOL[6:0] = 0 \times 7E$		-63		dB
Digital Volume Control Step Size				0.5		dB

Electrical Characteristics (continued)

($V_{PVDD} = 12V$, $V_{DVDD} = 1.8V$, $AGND = DGND = PGND = 0V$, $C_{PVDD} = 2 \times 10\mu F + 2 \times 0.1\mu F + 1 \times 220\mu F$, $C_{DVDD} = 1\mu F$, $Z_{VREFC} = 10\mu F + 30\Omega$, $Z_{SPK} = \text{Open}$, $SPK_GAIN_MAX = 0x7$, $SPK_FSW_SEL = 0$, AC Measurement Bandwidth = 20Hz to 20kHz, PCM Interface, $f_S = 48\text{kHz}$, 24-bit data, $T_A = T_{MIN}$ to T_{MAX} unless otherwise noted. Typical values are at $T_A = +25^\circ\text{C}$.) (Note 2)

PARAMETER	SYMBOL	CONDITION		MIN	TYP	MAX	UNITS
SPEAKER AMPLIFIER ELECTRICAL CHARACTERISTICS							
Output Offset Voltage	V_{OS}	$T_A = +25^\circ\text{C}$, $SPK_GAIN_MAX = 0x9$			± 1	± 3	mV
Click-and-Pop Level	K_{CP}	V_{PEAK} , $T_A = +25^\circ\text{C}$, 32 samples per second, zero-code input, A-weighted	Audio playback silent, amplifier disabled by software		-66		dBV
			Audio playback silent, amplifier enabled by software		-60		
Dynamic Range	DR	$V_{PVDD} = 16V$, $Z_L = 8\Omega + 33\mu H$, measured using the EIAJ method, -60dBFS at 1kHz output signal, referenced to output power at THD+N = 1%, A-weighted			110		dB
Integrated Output Noise	e_N	$Z_L = 8\Omega + 33\mu H$	A-weighted		35		μV_{RMS}
			Unweighted		45		
Output Power	P_{OUT}	THD+N $\leq 1\%$, f = 1kHz	$Z_L = 8\Omega + 33\mu H$		7.7		W
			$V_{PVDD} = 16V$, $Z_L = 8\Omega + 33\mu H$, $SPK_GAIN_MAX = 0x9$		13.5		
				$Z_L = 4\Omega + 33\mu H$		12.5	
		THD+N $\leq 10\%$, f = 1kHz	$Z_L = 8\Omega + 33\mu H$		9.6		
			$V_{PVDD} = 16V$, $Z_L = 8\Omega + 33\mu H$, $SPK_GAIN_MAX = 0x9$		16.9		
				$Z_L = 4\Omega + 33\mu H$		15.3	
Efficiency	η_{SPK}	f = 1kHz	$P_{OUT} = 10W$, $Z_L = 8\Omega + 33\mu H$		90.5		%
			$P_{OUT} = 15.3W$, $Z_L = 4\Omega + 33\mu H$		81.0		%

Electrical Characteristics (continued)

($V_{PVDD} = 12V$, $V_{DVDD} = 1.8V$, $AGND = DGND = PGND = 0V$, $C_{PVDD} = 2 \times 10\mu F + 2 \times 0.1\mu F + 1 \times 220\mu F$, $C_{DVDD} = 1\mu F$, $Z_{VREFC} = 10\mu F + 30\Omega$, $Z_{SPK} = \text{Open}$, $SPK_GAIN_MAX = 0 \times 7$, $SPK_FSW_SEL = 0$, AC Measurement Bandwidth = 20Hz to 20kHz, PCM Interface, $f_S = 48\text{kHz}$, 24-bit data, $T_A = T_{MIN}$ to T_{MAX} unless otherwise noted. Typical values are at $T_A = +25^\circ\text{C}$.) (Note 2)

PARAMETER	SYMBOL	CONDITION		MIN	TYP	MAX	UNITS
Total Harmonic Distortion + Noise	THD+N	f = 1kHz	$P_{OUT} = 3W$, $Z_{SPK} = 8\Omega + 33\mu H$		0.005		%
			$P_{OUT} = 6W$, $Z_{SPK} = 4\Omega + 33\mu H$	WLP Package	0.008		
				FCQFN Package	0.010		
		f = 6kHz	$P_{OUT} = 3W$, $Z_{SPK} = 8\Omega + 33\mu H$	WLP Package	0.025		
				FCQFN Package	0.035		
			$P_{OUT} = 6W$, $Z_{SPK} = 4\Omega + 33\mu H$	WLP Package	0.025		
		FCQFN Package	0.035				
Maximum Frequency Response Deviation		Maximum deviation above and below 1kHz reference			± 0.25		dB
Gain Error	A_{ERROR}	f = 1kHz, $V_O = 2.828V_{RMS}$		-0.5		+0.5	dB
Maximum Channel-to-Channel Phase Error		Output phase shift between multiple devices from 20Hz to 20kHz across all sample rates			1		$^\circ$
PVDD Power-Supply Rejection Ratio	PSRR	$V_{PVDD} = 5.5V$ to $16V$			85		dB
		$V_{RIPPLE} = 100mV_{P-P}$	$f_{RIPPLE} = 217\text{kHz}$		80		
			$f_{RIPPLE} = 1\text{kHz}$		80		
			$f_{RIPPLE} = 10\text{kHz}$		67		
DVDD Power-Supply Rejection Ratio	PSRR	$f_{RIPPLE} = 1\text{kHz}$, $V_{RIPPLE} = 50mV_{P-P}$			83		dB
Output Switching Frequency	f_{SW}	Constant across all sample rates in the 48kHz family	$SPK_FSW_SEL = 1$		330		kHz
			$SPK_FSW_SEL = 0$		472		
		Constant across all sample rates in the 44.1kHz family	$SPK_FSW_SEL = 1$		322		
			$SPK_FSW_SEL = 0$		451		
Output Stage On-Resistance	R_{ON}	PMOS + NMOS			425		m Ω
Current Limit	I_{LIM}			4.5	6.0		A
Spread-Spectrum Bandwidth		$SPK_FSW_SEL = 1$, $SPK_SSM_EN = 1$, $MMI = 3/6$			± 23		kHz
		$SPK_FSW_SEL = 0$, $SPK_SSM_EN = 1$, $MMI = 1/6$			± 28		

Electrical Characteristics (continued)

($V_{PVDD} = 12V$, $V_{DVDD} = 1.8V$, $AGND = DGND = PGND = 0V$, $C_{PVDD} = 2 \times 10\mu F + 2 \times 0.1\mu F + 1 \times 220\mu F$, $C_{DVDD} = 1\mu F$, $Z_{VREFC} = 10\mu F + 30\Omega$, $Z_{SPK} = \text{Open}$, $SPK_GAIN_MAX = 0x7$, $SPK_FSW_SEL = 0$, AC Measurement Bandwidth = 20Hz to 20kHz, PCM Interface, $f_S = 48kHz$, 24-bit data, $T_A = T_{MIN}$ to T_{MAX} unless otherwise noted. Typical values are at $T_A = +25^\circ C$.) (Note 2)

PARAMETER	SYMBOL	CONDITION	MIN	TYP	MAX	UNITS
BROWNOUT-DETECTION ENGINE (BDE)						
BDE Gain Attack Delay Time to Gain Change		Measurement ADC sample rate set to 333kHz, PVDD channel filter disabled		13	20	μs
BDE Gain Attack Delay Time to Interrupt		Measurement ADC sample rate set to 333kHz, PVDD channel filter disabled		5		μs
THERMAL SHUTDOWN						
Trigger Point		THERMSHDN_THRESH = 0x27		150		$^\circ C$
Maximum Thermal Hysteresis		THERM_HYST = 0x3		6.4		$^\circ C$
MEASUREMENT ADC PVDD CHANNEL						
Resolution				8		Bits
Absolute Error				1.2		%
ADC Voltage Range			5.35		16.15	V
DIGITAL I/O CHARACTERISTICS						
INPUT (LRCLK, ICC, RESET)						
Input-Voltage High	V_{IH}		0.7 x V_{DVDD}			V
Input-Voltage Low	V_{IL}				0.3 x V_{DVDD}	V
Input Leakage Current			-3		+3	μA
Input Hysteresis	V_{HYST}		0.15 x V_{DVDD}			V
Input Capacitance	C_{IN}		5			pF
Internal Pulldown Resistance	R_{PD}	LRCLK and ICC	1			M Ω
INPUT (SDA, SCL, ADDR)						
Input-Voltage High	V_{IH}		0.7 x V_{DVDD}			V
Input-Voltage Low	V_{IL}				0.3 x V_{DVDD}	V
Input Leakage Current		$T_A = +25^\circ C$, input high	-1		+1	μA
Input Hysteresis	V_{HYST}		200			mV
Input Capacitance	C_{IN}		10			pF

Electrical Characteristics (continued)

($V_{PVDD} = 12V$, $V_{DVDD} = 1.8V$, $AGND = DGND = PGND = 0V$, $C_{PVDD} = 2 \times 10\mu F + 2 \times 0.1\mu F + 1 \times 220\mu F$, $C_{DVDD} = 1\mu F$, $Z_{VREFC} = 10\mu F + 30\Omega$, $Z_{SPK} = \text{Open}$, $SPK_GAIN_MAX = 0 \times 7$, $SPK_FSW_SEL = 0$, AC Measurement Bandwidth = 20Hz to 20kHz, PCM Interface, $f_S = 48\text{kHz}$, 24-bit data, $T_A = T_{MIN}$ to T_{MAX} unless otherwise noted. Typical values are at $T_A = +25^\circ\text{C}$.) (Note 2)

PARAMETER	SYMBOL	CONDITION	MIN	TYP	MAX	UNITS
INPUT (DIN/SWDATA, BCLK/SWCLK—PCM INTERFACE MODE)						
Input-Voltage High	V_{IH}		0.65 x V_{DVDD}			V
Input-Voltage Low	V_{IL}				0.35 x V_{DVDD}	V
Input Leakage Current			-5		+5	μA
Input Hysteresis	V_{HYST}	BCLK/SWCLK (Note 3)	0.10 x V_{DVDD}			V
		DIN/SWDATA		0.15 x V_{DVDD}		
Input Capacitance	C_{IN}			5		pF
Internal Pulldown Resistance	R_{PD}			1		M Ω
OPEN-DRAIN OUTPUT (SDA, IRQ)						
Output Low Voltage	V_{OL}	$I_{SINK} = 3\text{mA}$			0.4	V
Output High Leakage Current	I_{OH}	$T_A = +25^\circ\text{C}$	-1		+1	μA
PUSH-PULL OUTPUT (DOUT, ICC, IRQ)						
Output-Voltage High	V_{OH}	$I_{OH} = 3\text{mA}$	$V_{DVDD} - 0.3$			V
Output-Voltage Low	V_{OL}	$I_{OL} = 3\text{mA}$			0.3	V
Output Current	I_{OH}	Reduced drive mode		6		mA
		Normal drive mode		9		
		High drive mode		15		
		Highest drive mode		20		
INPUT/OUTPUT (DIN/SWDATA, BCLK/SWCLK—SOUNDWIRE COMPATIBLE INTERFACE MODE)						
Data Input-Voltage High	V_{IHmin_Data}	DIN/SWDATA Input	0.65 x V_{DVDD}			V
Data Input-Voltage Low	V_{ILmax_Data}	DIN/SWDATA Input			0.35 x V_{DVDD}	V
Clock Input Threshold for Rising (Positive) Edges	V_{TP_Clock}	BCLK/SWCLK	0.50 x V_{DVDD}		0.65 x V_{DVDD}	V
Clock Input Threshold for Falling (Negative) Edges	V_{TN_Clock}	BCLK/SWCLK	0.35 x V_{DVDD}		0.50 x V_{DVDD}	V

Electrical Characteristics (continued)

($V_{PVDD} = 12V$, $V_{DVDD} = 1.8V$, $AGND = DGND = PGND = 0V$, $C_{PVDD} = 2 \times 10\mu F + 2 \times 0.1\mu F + 1 \times 220\mu F$, $C_{DVDD} = 1\mu F$, $Z_{VREFC} = 10\mu F + 30\Omega$, $Z_{SPK} = \text{Open}$, $SPK_GAIN_MAX = 0x7$, $SPK_FSW_SEL = 0$, AC Measurement Bandwidth = 20Hz to 20kHz, PCM Interface, $f_S = 48\text{kHz}$, 24-bit data, $T_A = T_{MIN}$ to T_{MAX} unless otherwise noted. Typical values are at $T_A = +25^\circ\text{C}$.) (Note 2)

PARAMETER	SYMBOL	CONDITION	MIN	TYP	MAX	UNITS
Clock Threshold Hysteresis	V_{Hys_Clock}	BCLK/SWCLK (Note 3)	0.10 x V_{DVDD}			V
Data Output-Voltage High	V_{OH_Data}	DIN/SWDATA output	0.80 x V_{DVDD}			V
Data Output-Voltage Low	V_{OL_Data}	DIN/SWDATA output			0.20 x V_{DVDD}	V
Input Leakage Current			-5		+5	μA
Maximum Input Capacitance	C_{IN}			5		pF
Pulldown Resistance	R_{PD}			1		M Ω

PCM and ICC Interface Timing Characteristics

($V_{PVDD} = 12V$, $V_{DVDD} = 1.8V$, $AGND = DGND = PGND = 0V$, $C_{PVDD} = 2 \times 10\mu F + 2 \times 0.1\mu F + 1 \times 220\mu F$, $C_{DVDD} = 1\mu F$, $Z_{VREFC} = 10\mu F + 30\Omega$, $Z_{SPK} = \text{Open}$, $SPK_GAIN_MAX = 0x7$, $SPK_FSW_SEL = 0$, AC Measurement Bandwidth = 20Hz to 20kHz, PCM Interface, $f_S = 48\text{kHz}$, 24-bit data, $T_A = T_{MIN}$ to T_{MAX} unless otherwise noted. Typical values are at $T_A = +25^\circ\text{C}$.) (Note 2)

PARAMETER	SYMBOL	CONDITION	MIN	TYP	MAX	UNITS
PCM INTERFACE CHARACTERISTICS						
LRCLK Frequency Range	f_{LRCLK}		16		96	kHz
Word Length			16		bits	
			24			
			32			
BCLK Duty Cycle			45		55	%
BCLK Period	t_{BCLK}		65			ns
Maximum BCLK/LRCLK Input Jitter		Maximum allowable jitter before a -20dBFS, 20kHz input has a 1dB reduction in THD+N, RMS jitter $\leq 40\text{kHz}$	0.2		ns	
		Maximum allowable jitter before a -60dBFS, 20kHz input has a 1dB reduction in THD+N, RMS jitter $> 40\text{kHz}$	2.5			

PCM and ICC Interface Timing Characteristics (continued)

($V_{PVDD} = 12V$, $V_{DVDD} = 1.8V$, $AGND = DGND = PGND = 0V$, $C_{PVDD} = 2 \times 10\mu F + 2 \times 0.1\mu F + 1 \times 220\mu F$, $C_{DVDD} = 1\mu F$, $Z_{VREFC} = 10\mu F + 30\Omega$, $Z_{SPK} = \text{Open}$, $SPK_GAIN_MAX = 0x7$, $SPK_FSW_SEL = 0$, AC Measurement Bandwidth = 20Hz to 20kHz, PCM Interface, $f_S = 48kHz$, 24-bit data, $T_A = T_{MIN}$ to T_{MAX} unless otherwise noted. Typical values are at $T_A = +25^\circ C$.) (Note 2)

PARAMETER	SYMBOL	CONDITION	MIN	TYP	MAX	UNITS
PCM INTERFACE TIMING						
LRCLK to BCLK Active Edge Setup Time	$t_{SYNCSET}$		4			ns
LRCLK to BCLK Active Edge Hold Time	$t_{SYNHOLD}$		4			ns
DIN to BCLK Active Edge Setup Time	t_{SETUP}		4			ns
DIN to BCLK Active Edge Hold Time	t_{HOLD}		4			ns
DIN Frame Delay after LRCLK Edge		Measured in number of BCLK cycles, set by selected TDM mode	0		2	cycles
PCM DATA OUPUT (DOUT)						
BCLK Inactive Edge to DOUT Delay	t_{CLKTX}				25	ns
BCLK Active Edge to DOUT Hi-Z Delay	t_{HIZ}		4		29	ns
BCLK Inactive Edge to DOUT Active Delay	t_{ACTV}		0		25	ns
ICC TIMING						
ICC to BCLK Active Edge Setup Time	t_{SETUP}		4			ns
ICC to BCLK Active Edge Hold Time	t_{HOLD}		4			ns
BCLK Inactive Edge to ICC Delay	t_{CLKTX}				25	ns
BCLK Active Edge to ICC Hi-Z Delay	t_{HIZ}		4		29	ns
BCLK Inactive Edge to ICC Active Delay	t_{ACTV}		0		25	ns

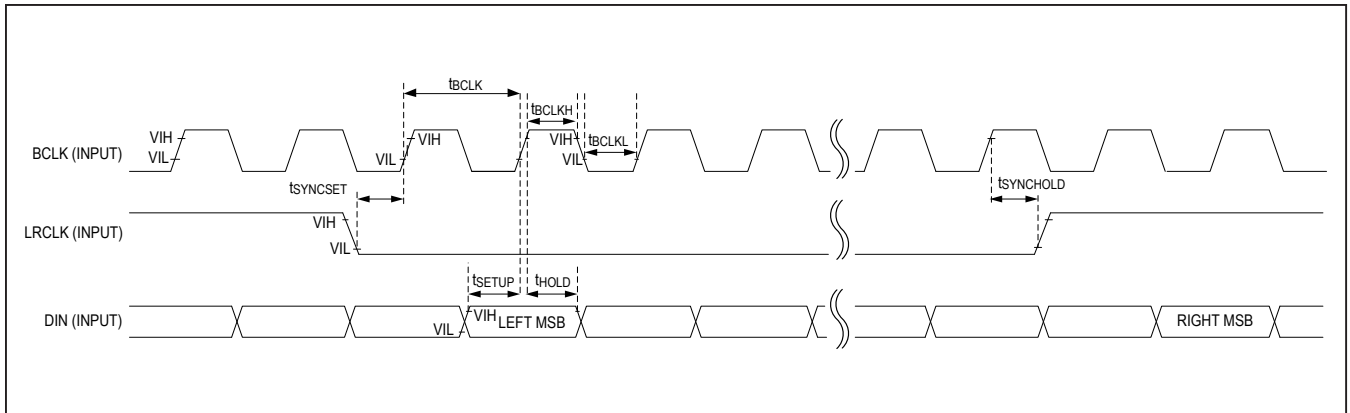

Figure 1. I²S Audio Interface Timing Diagram

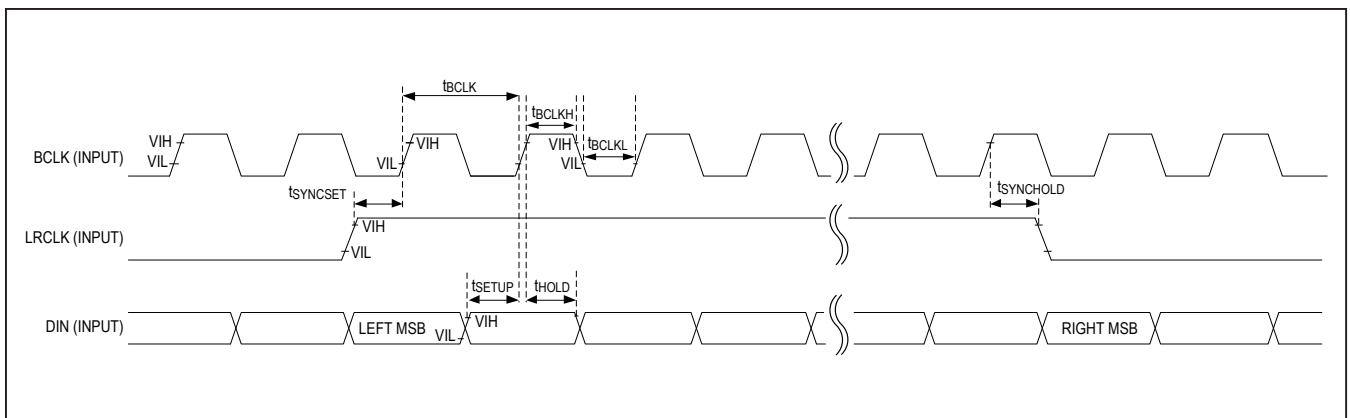

Figure 2. Left-Justified Audio Interface Timing Diagram

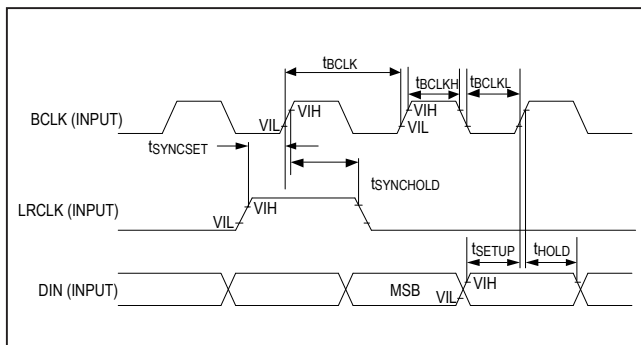

Figure 3. TDM Interface Timing Diagram

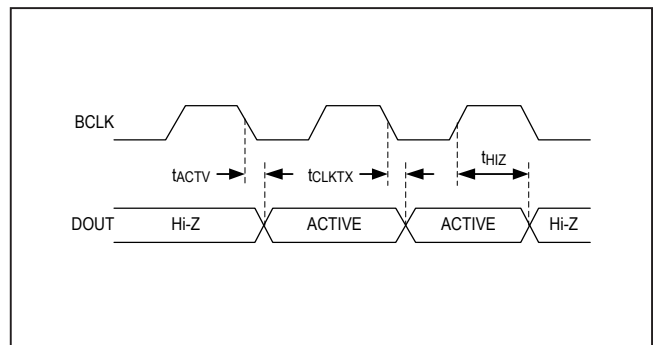

Figure 4. PCM Data Output Timing (DOUT)

I²C Interface Timing Characteristics

(V_{PVDD} = 12V, V_{DVDD} = 1.8V, AGND = DGND = PGND = 0V, C_{PVDD} = 2x10μF + 2x0.1μF + 1x220μF, C_{DVDD} = 1μF, Z_{VREFC} = 10μF + 30Ω, Z_{SPK} = Open, SPK_GAIN_MAX = 0x7, SPK_FSW_SEL = 0, AC Measurement Bandwidth = 20Hz to 20kHz, PCM Interface, f_S = 48kHz, 24-bit data, T_A = T_{MIN} to T_{MAX} unless otherwise noted. Typical values are at T_A = +25°C.) (Note 2)

PARAMETER	SYMBOL	CONDITIONS	MIN	TYP	MAX	UNITS
Serial Clock Frequency	f _{SCL}		0		1000	kHz
Bus Free Time Between STOP and START Conditions	t _{BUF}		0.5			μs
Hold Time (Repeated) START Condition	t _{HD,STA}		0.26			μs
SCL Pulse-Width Low	t _{LOW}		0.5			μs
SCL Pulse-Width High	t _{HIGH}		0.26			μs
Setup Time for a Repeated START Condition	t _{SU,STA}		0.26			μs
Data Hold Time	t _{HD,DAT}		0		900	ns
Data Setup Time	t _{SU,DAT}		50			ns
SDA and SCL Receiving Rise Time	t _R		20 + 0.1C _B		120	ns
SDA and SCL Receiving Fall Time	t _F		20 + 0.1C _B		120	ns
SDA Transmitting Fall Time	t _F	V _{DVDD} = 1.71V	20		120	ns
Setup Time for STOP Condition	t _{SU,STO}		0.26			μs
Bus Capacitance	C _B				550	pF
Pulse Width of Suppressed Spike	t _{SP}		0		50	ns

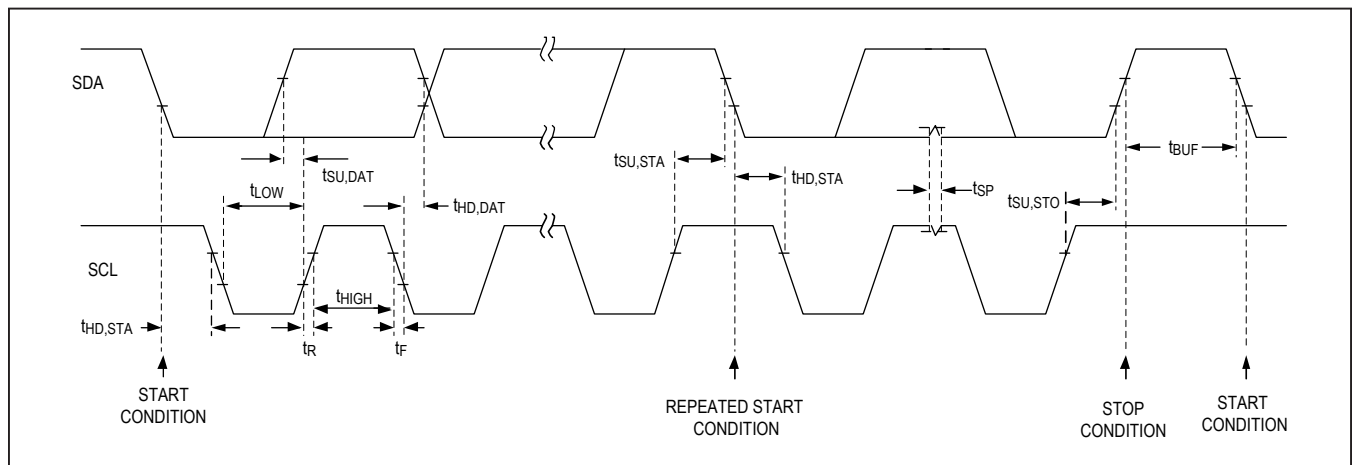

Figure 5. I²C Timing

SoundWire Compatible Slave Interface Timing Characteristics

($V_{PVDD} = 12V$, $V_{DVDD} = 1.8V$, $AGND = DGND = PGND = 0V$, $C_{PVDD} = 2 \times 10\mu F + 2 \times 0.1\mu F + 1 \times 220\mu F$, $C_{DVDD} = 1\mu F$, $Z_{VREFC} = 10\mu F + 30\Omega$, $Z_{SPK} = \text{Open}$, $SPK_GAIN_MAX = 0 \times 7$, $SPK_FSW_SEL = 0$, AC Measurement Bandwidth = 20Hz to 20kHz, PCM Interface, $f_S = 48kHz$, 24-bit data, $T_A = T_{MIN}$ to T_{MAX} unless otherwise noted. Typical values are at $T_A = +25^\circ C$.) (Note 2)

PARAMETER	SYMBOL	CONDITIONS	MIN	TYP	MAX	UNITS
Frequency of Clock	f_Clock				12.7	MHz
Clock Input Duty Cycle	DC_In_Clock		45		55	%
Minimum Data Output Slew Time	t_Slew_Data	$10pF \leq C_{BUS_DATA} \leq 60pF$ (Note 5)		0.5		ns
		$60pF < C_{BUS_DATA} \leq 100pF$ (Note 5)		1.4		
Minimum Data Input Setup Time	t_ISetup_min_Data	(Note 3)			0	ns
Minimum Data Input Hold Time	t_IHold_min_Data	(Note 3)			4	ns
Data Output Disable Time	t_DZ_Data	(Note 3)			4	ns
Data Output Enable Time	t_ZD_Data	(Note 3)	7.9			ns
Minimum Time for Data Output to Remain Stable	t_OH_Data	(Note 5)		6.7		ns
Clock Edge to Valid Data Output for Small Systems	t_OV_Data	$10pF \leq C_{BUS_DATA} \leq 60pF$ (Note 3)			27.9	ns
Clock Edge to Valid Data Output for Large Systems	t_OV_Data	$10pF \leq C_{BUS_DATA} \leq 100pF$ (Note 3)			31.6	ns

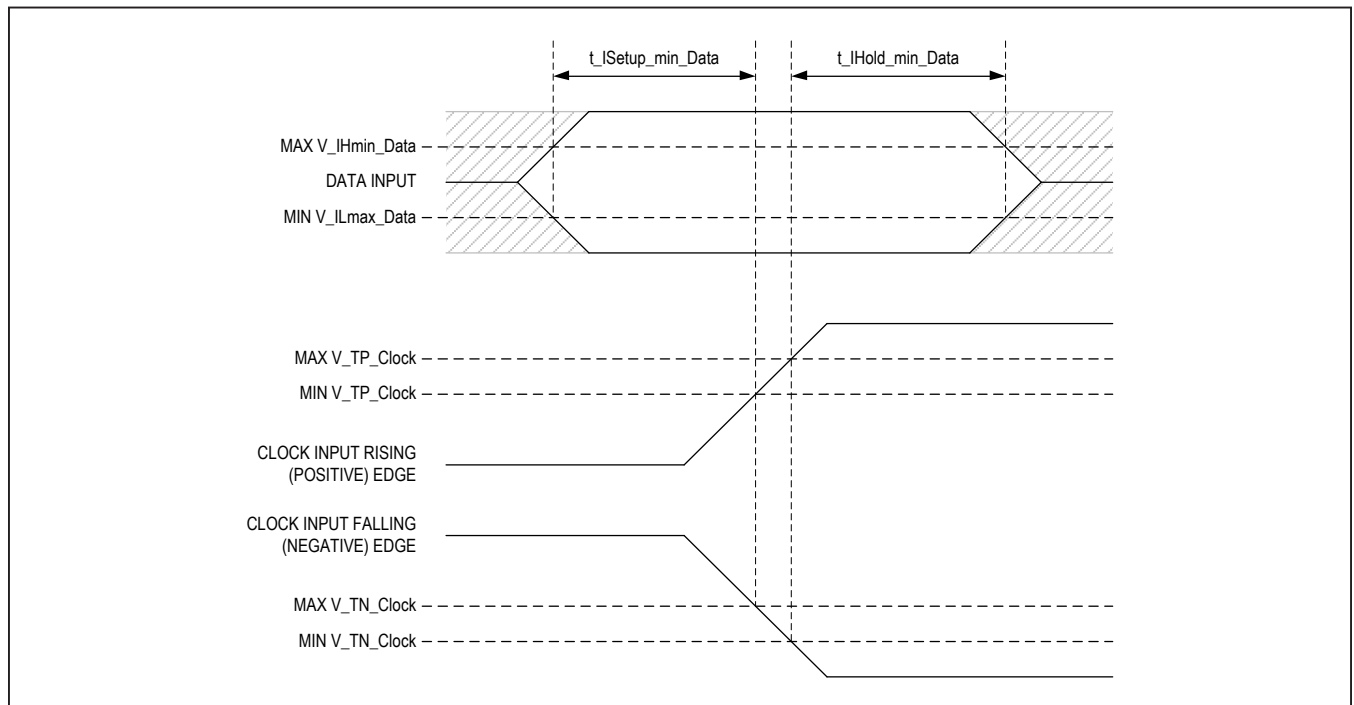

Figure 6. SoundWire Data Input Timing Diagram

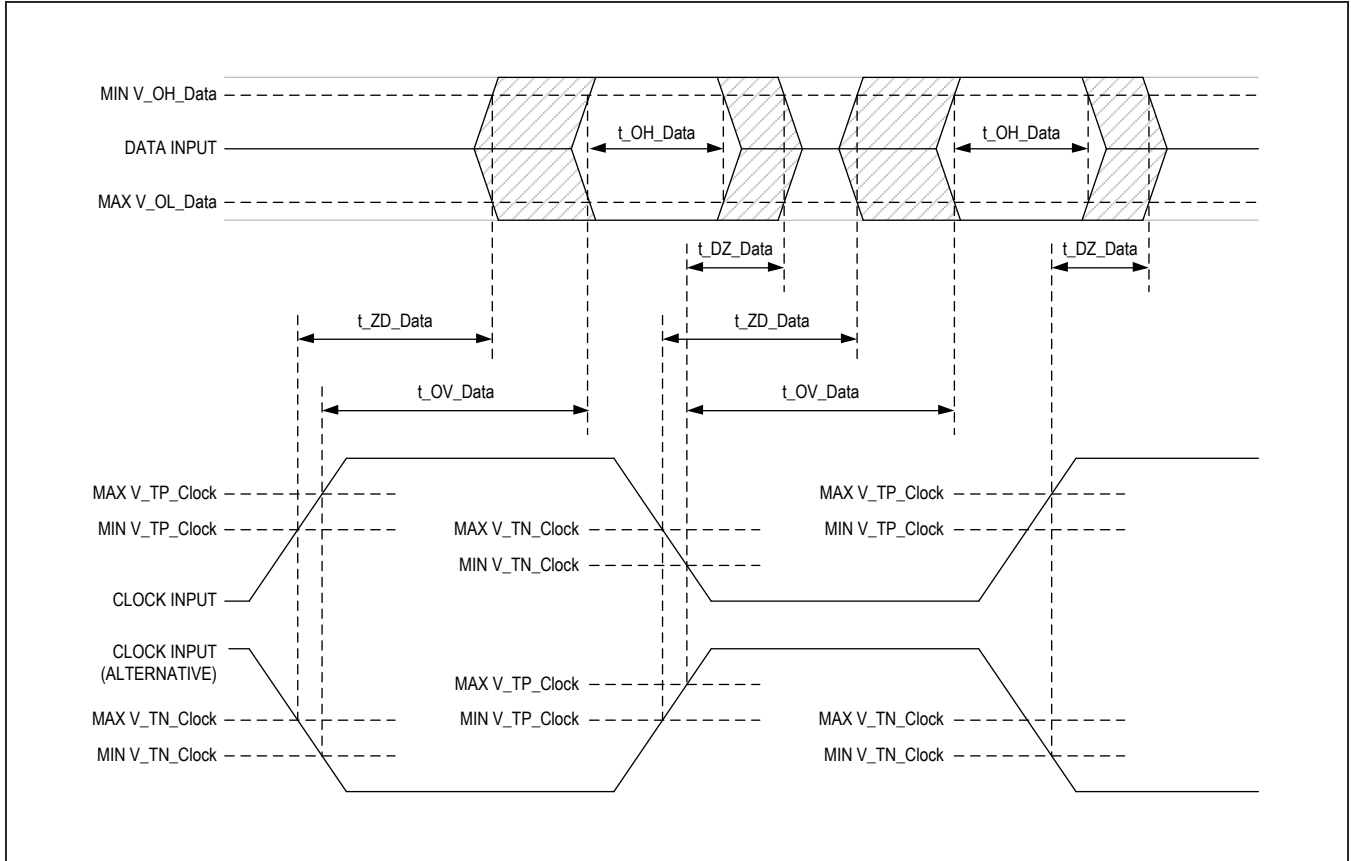

Figure 7. SoundWire Data Output Timing Diagram

Device Reset Timing Characteristics

($V_{PVDD} = 12V$, $V_{DVDD} = 1.8V$, $AGND = DGND = PGND = 0V$, $C_{PVDD} = 2 \times 10\mu F + 2 \times 0.1\mu F + 1 \times 220\mu F$, $C_{DVDD} = 1\mu F$, $Z_{VREFC} = 10\mu F + 30\Omega$, $Z_{SPK} = \text{Open}$, $SPK_GAIN_MAX = 0x7$, $SPK_FSW_SEL = 0$, AC Measurement Bandwidth = 20Hz to 20kHz, PCM Interface, $f_S = 48kHz$, 24-bit data, $T_A = T_{MIN}$ to T_{MAX} unless otherwise noted. Typical values are at $T_A = +25^\circ C$.) (Note 2)

PARAMETER	SYMBOL	CONDITIONS	MIN	TYP	MAX	UNITS
\overline{RESET} Low	t_{RESET_LOW}	Minimum low time for \overline{RESET} to ensure device shutdown		1		μs
Release from \overline{RESET}	t_{I2C_READY}	Time from rising edge of \overline{RESET} to I ² C communication available		1.5		ms

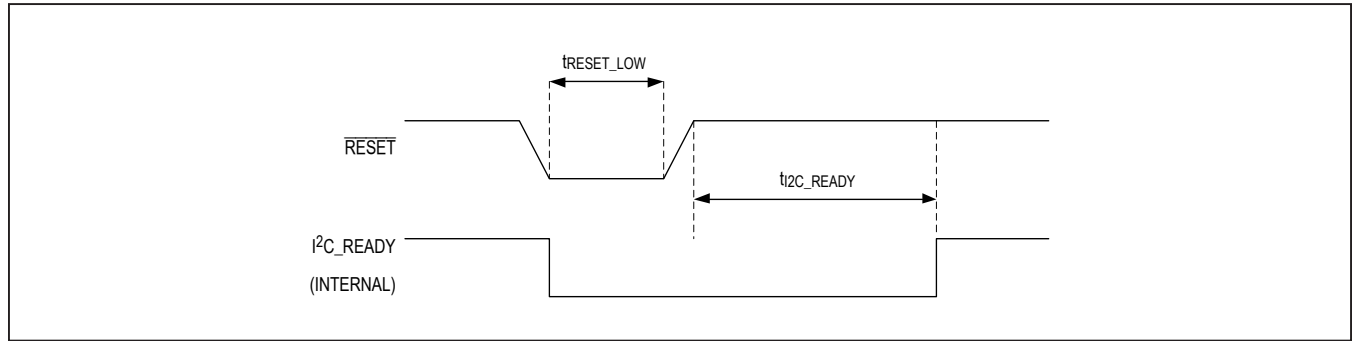
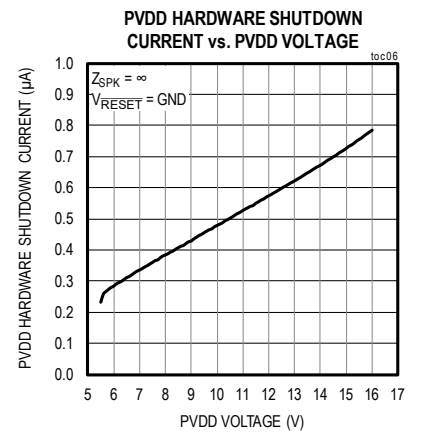
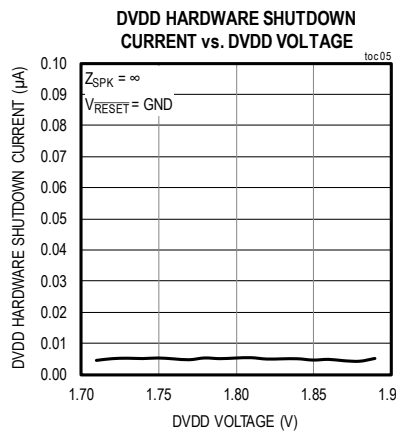
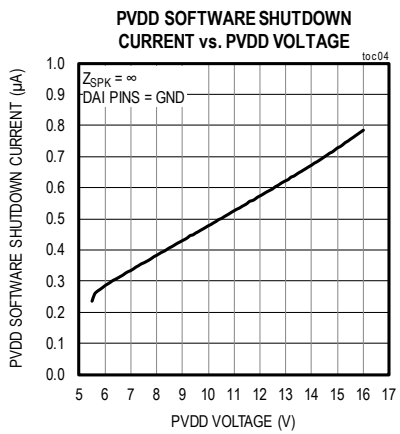
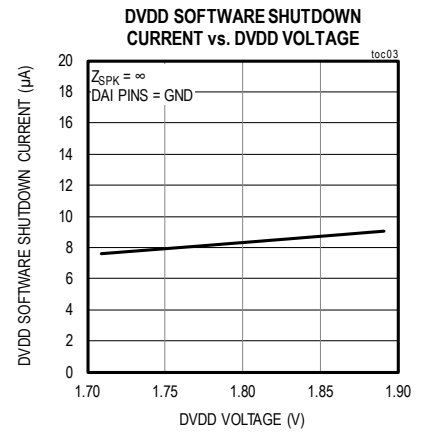
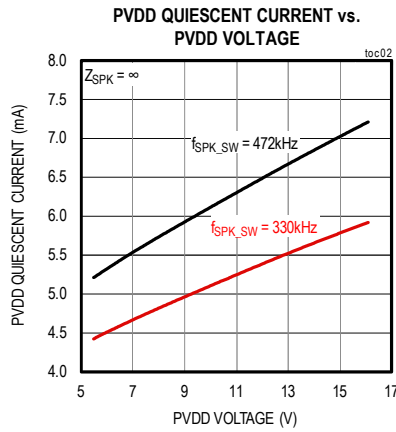
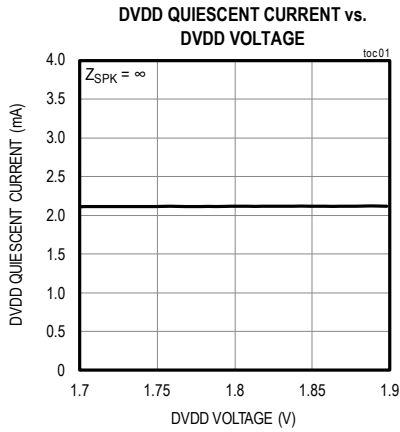

Figure 8. \overline{RESET} Timing Diagram

- Note 2:** 100% production tested at $T_A = +25^\circ C$. Specifications over temperature limits are guaranteed by design, unless otherwise noted.
- Note 3:** Minimums and/or maximum limits shown are design targets and not 100% production tested.
- Note 4:** Digital filter performance is invariant over temperature and is production tested at $T_A = +25^\circ C$.
- Note 5:** Values shown as typical due to limitation of production test method. Based on silicon simulation results, the typical values shown represent the worst-case minimum for these specifications.

Typical Operating Characteristics

($V_{PVDD} = 12V$, $V_{DVDD} = 1.8V$, $AGND = DGND = PGND = 0V$, $C_{PVDD} = 2 \times 10\mu F + 2 \times 0.1\mu F + 1 \times 220\mu F$, $C_{DVDD} = 1\mu F$, $Z_{VREFC} = 10\mu F + 30\Omega$, $Z_{SPK} = \text{Open}$, $SPK_GAIN_MAX = 0 \times 7$, $SPK_FSW_SEL = 0$, AC Measurement Bandwidth = 20Hz to 20kHz, PCM Interface, $f_S = 48kHz$, 24-bit data, $T_A = T_{MIN}$ to T_{MAX} . Typical values are at $T_A = +25^\circ C$.)



Typical Operating Characteristics (continued)

($V_{PVDD} = 12V$, $V_{DVDD} = 1.8V$, $AGND = DGND = PGND = 0V$, $C_{PVDD} = 2 \times 10\mu F + 2 \times 0.1\mu F + 1 \times 220\mu F$, $C_{DVDD} = 1\mu F$, $Z_{VREFC} = 10\mu F + 30\Omega$, $Z_{SPK} = \text{Open}$, $SPK_GAIN_MAX = 0x7$, $SPK_FSW_SEL = 0$, AC Measurement Bandwidth = 20Hz to 20kHz, PCM Interface, $f_S = 48kHz$, 24-bit data, $T_A = T_{MIN}$ to T_{MAX} . Typical values are at $T_A = +25^\circ C$.)

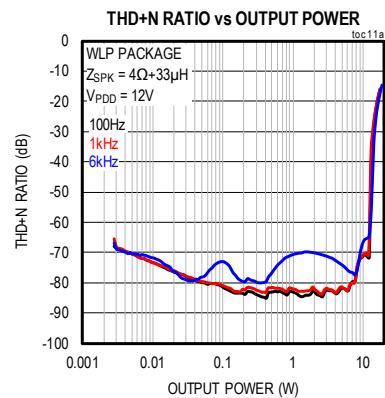
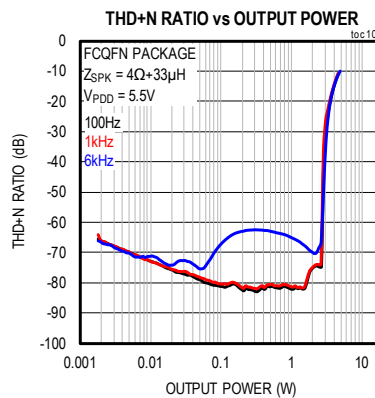
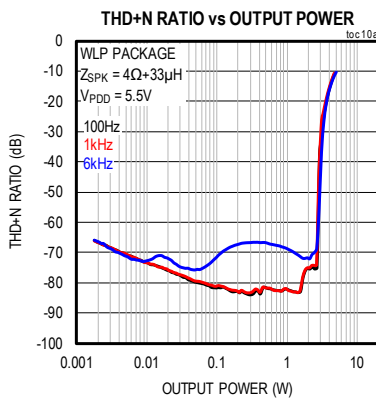
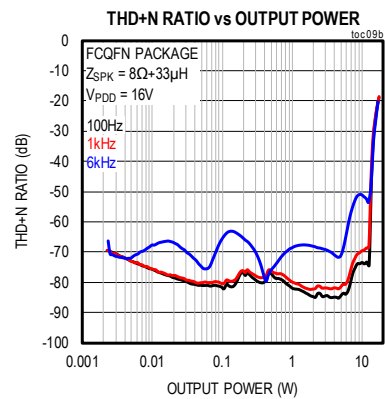
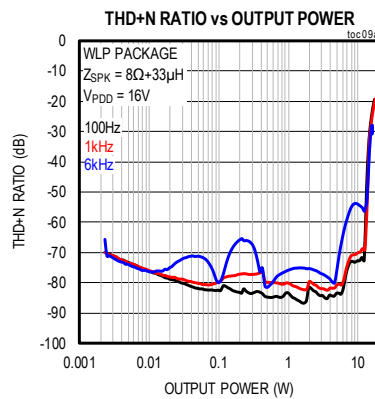
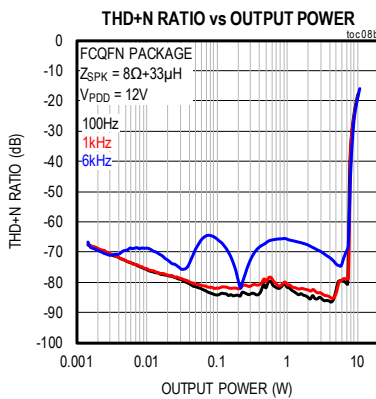
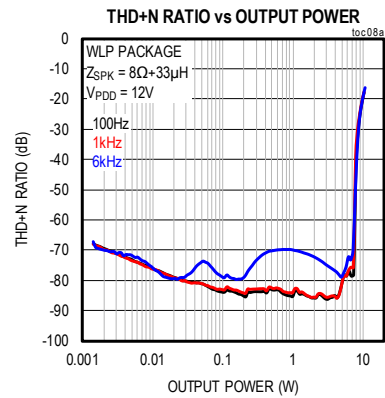
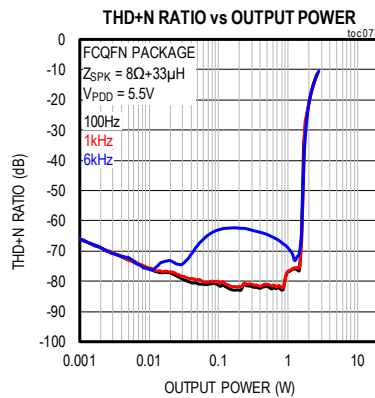
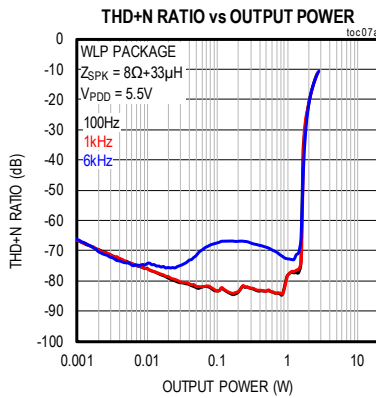

Typical Operating Characteristics (continued)

($V_{PVDD} = 12V$, $V_{DVDD} = 1.8V$, $AGND = DGND = PGND = 0V$, $C_{PVDD} = 2 \times 10\mu F + 2 \times 0.1\mu F + 1 \times 220\mu F$, $C_{DVDD} = 1\mu F$, $Z_{VREFC} = 10\mu F + 30\Omega$, $Z_{SPK} = \text{Open}$, $SPK_GAIN_MAX = 0x7$, $SPK_FSW_SEL = 0$, AC Measurement Bandwidth = 20Hz to 20kHz, PCM Interface, $f_S = 48kHz$, 24-bit data, $T_A = T_{MIN}$ to T_{MAX} . Typical values are at $T_A = +25^\circ C$.)

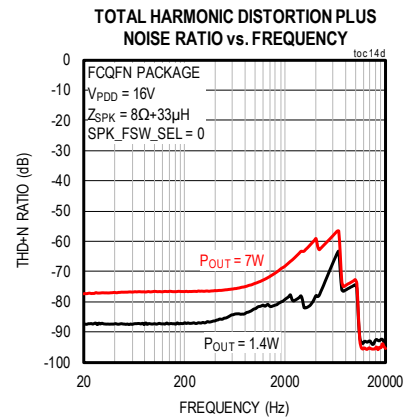
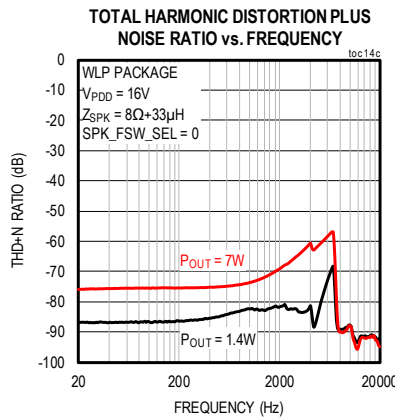
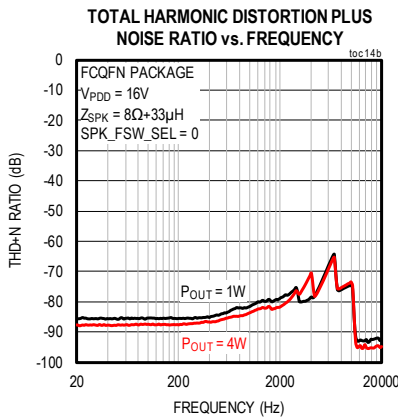
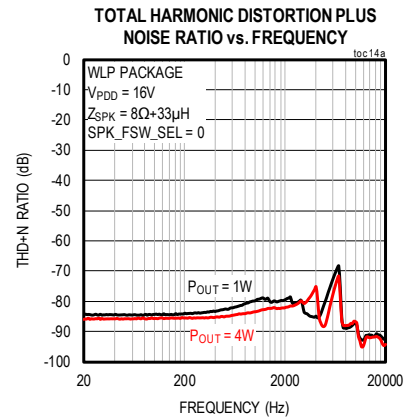
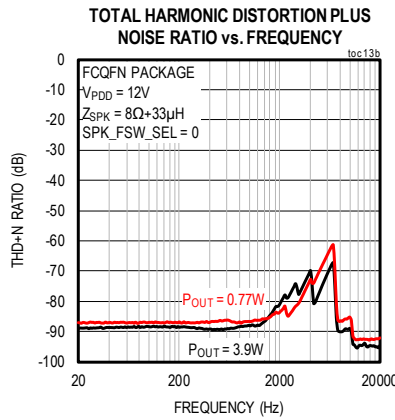
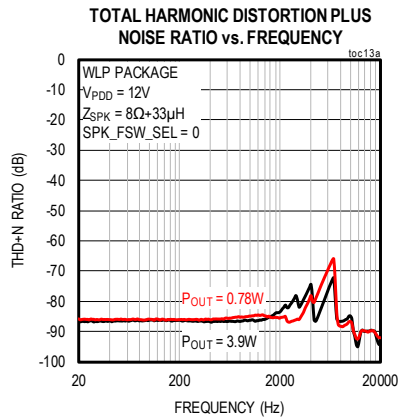
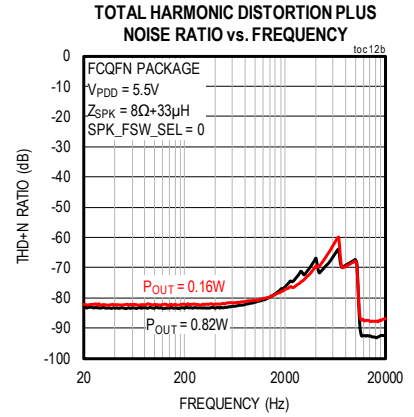
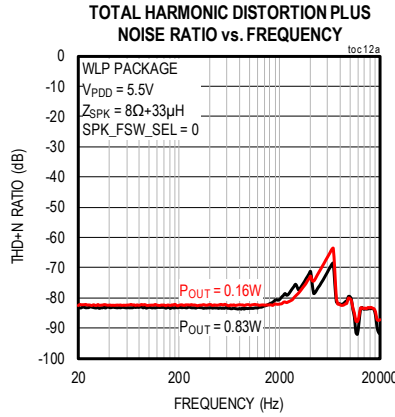
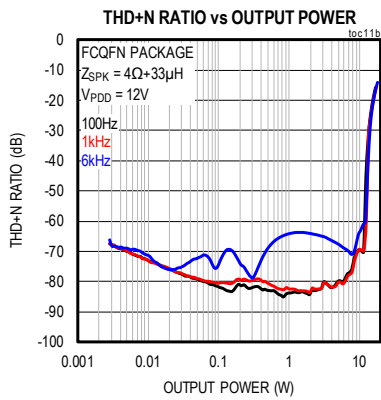

Typical Operating Characteristics (continued)

($V_{PVDD} = 12V$, $V_{DVDD} = 1.8V$, $AGND = DGND = PGND = 0V$, $C_{PVDD} = 2 \times 10\mu F + 2 \times 0.1\mu F + 1 \times 220\mu F$, $C_{DVDD} = 1\mu F$, $Z_{VREFC} = 10\mu F + 30\Omega$, $Z_{SPK} = \text{Open}$, $SPK_GAIN_MAX = 0 \times 7$, $SPK_FSW_SEL = 0$, AC Measurement Bandwidth = 20Hz to 20kHz, PCM Interface, $f_S = 48kHz$, 24-bit data, $T_A = T_{MIN}$ to T_{MAX} . Typical values are at $T_A = +25^\circ C$.)

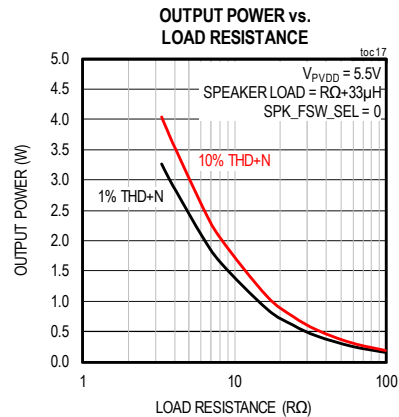
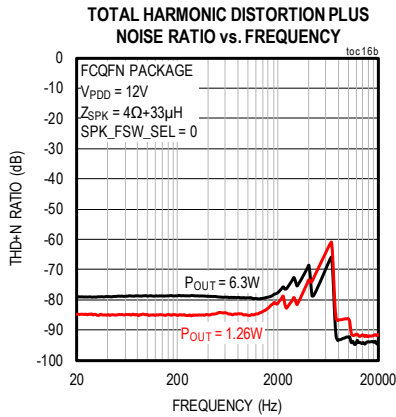
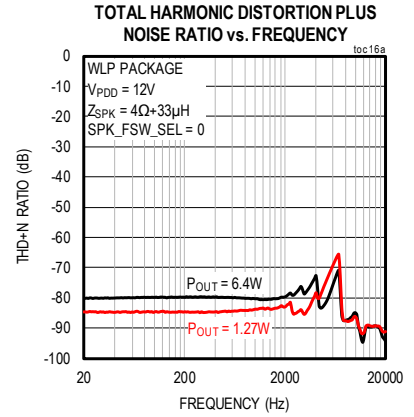
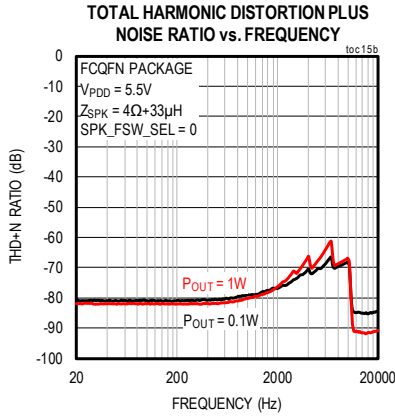
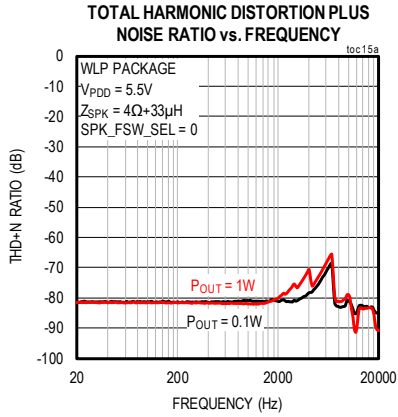

Typical Operating Characteristics (continued)

($V_{PVDD} = 12V$, $V_{DVDD} = 1.8V$, $AGND = DGND = PGND = 0V$, $C_{PVDD} = 2 \times 10\mu F + 2 \times 0.1\mu F + 1 \times 220\mu F$, $C_{DVDD} = 1\mu F$, $Z_{VREFC} = 10\mu F + 30\Omega$, $Z_{SPK} = \text{Open}$, $SPK_GAIN_MAX = 0x7$, $SPK_FSW_SEL = 0$, AC Measurement Bandwidth = 20Hz to 20kHz, PCM Interface, $f_S = 48kHz$, 24-bit data, $T_A = T_{MIN}$ to T_{MAX} . Typical values are at $T_A = +25^\circ C$.)

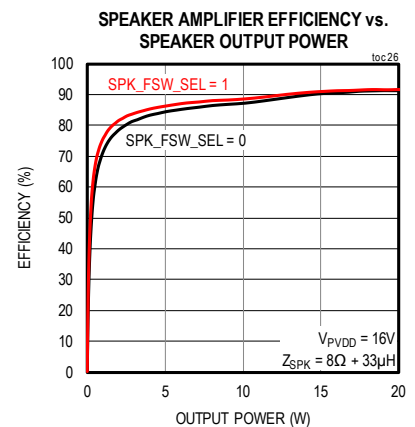
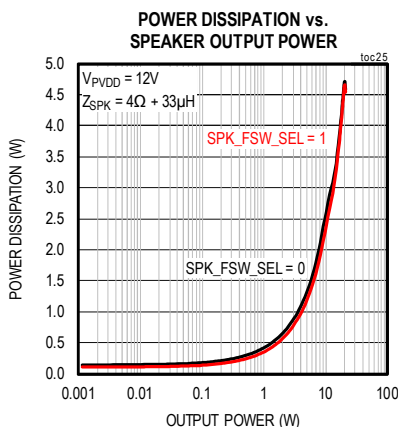
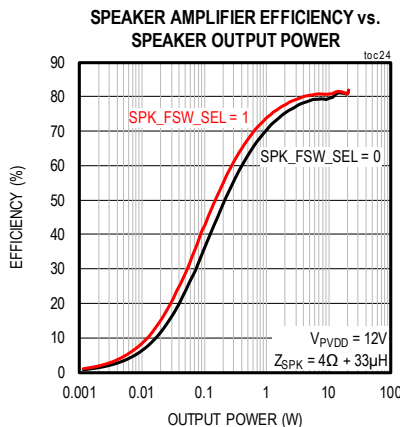
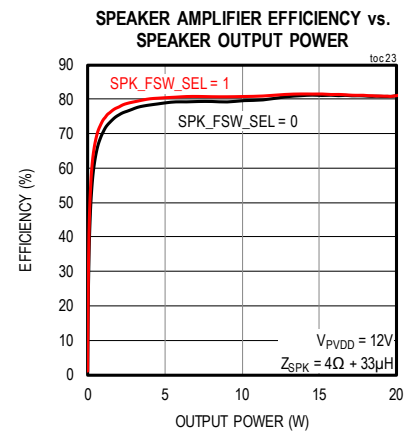
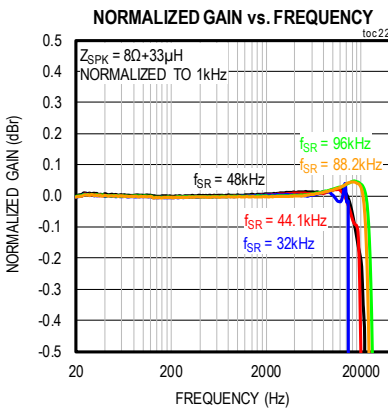
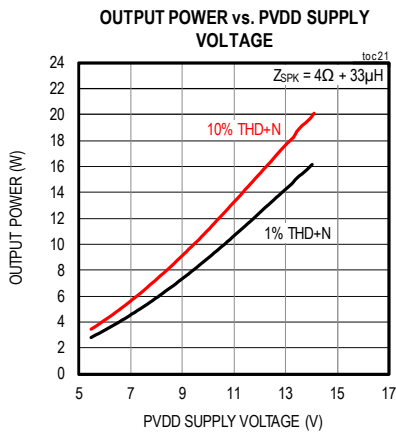
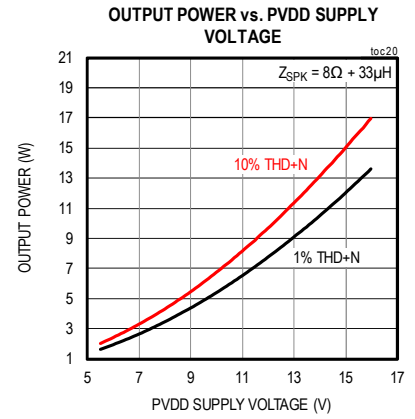
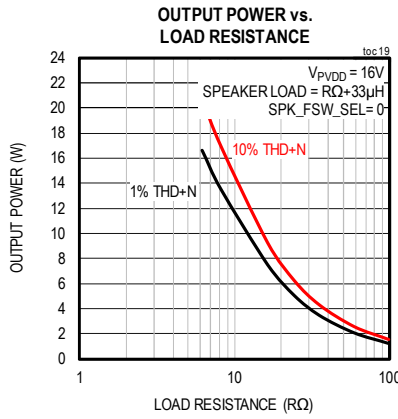
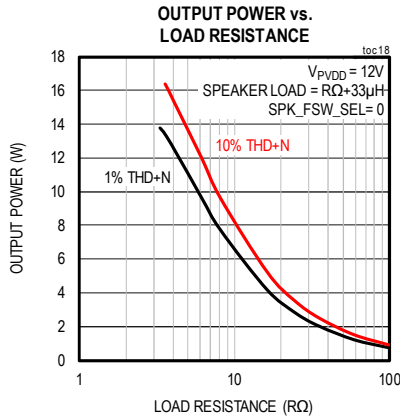

Typical Operating Characteristics (continued)

($V_{PVDD} = 12V$, $V_{DVDD} = 1.8V$, $AGND = DGND = PGND = 0V$, $C_{PVDD} = 2 \times 10\mu F + 2 \times 0.1\mu F + 1 \times 220\mu F$, $C_{DVDD} = 1\mu F$, $Z_{VREFC} = 10\mu F + 30\Omega$, $Z_{SPK} = \text{Open}$, $SPK_GAIN_MAX = 0x7$, $SPK_FSW_SEL = 0$, AC Measurement Bandwidth = 20Hz to 20kHz, PCM Interface, $f_S = 48kHz$, 24-bit data, $T_A = T_{MIN}$ to T_{MAX} . Typical values are at $T_A = +25^\circ C$.)

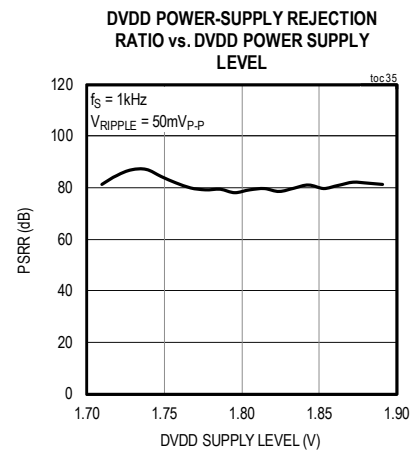
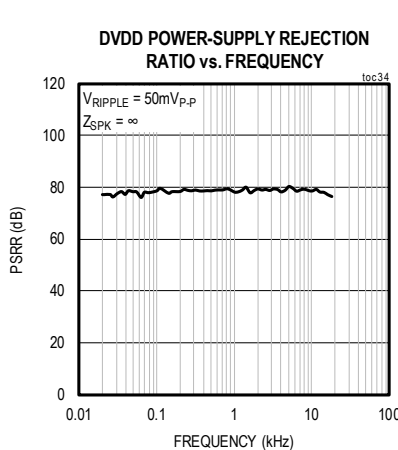
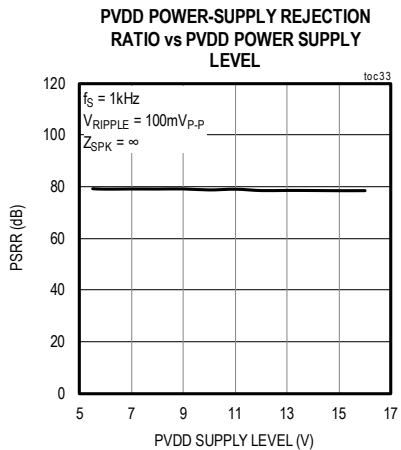
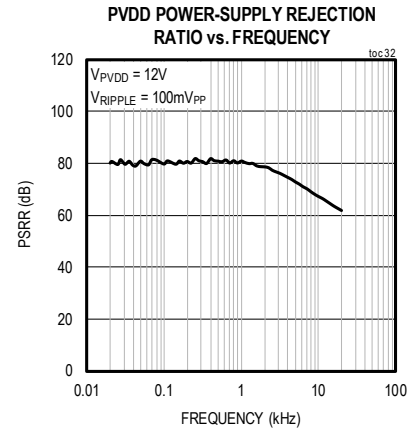
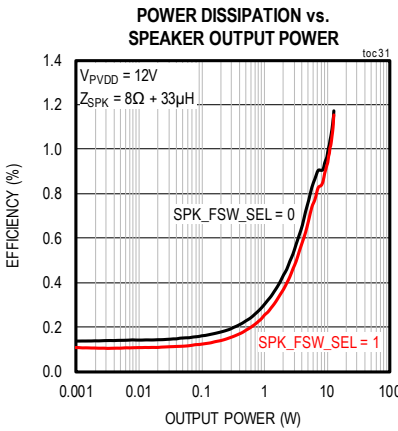
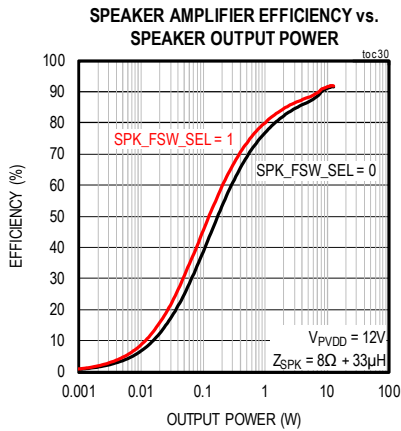
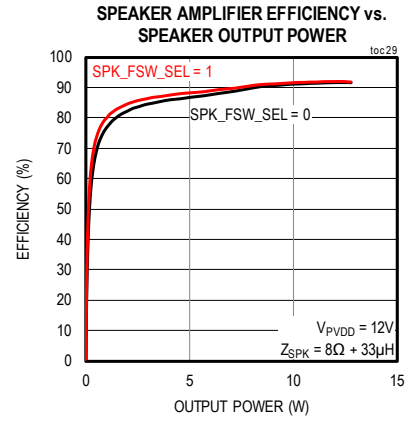
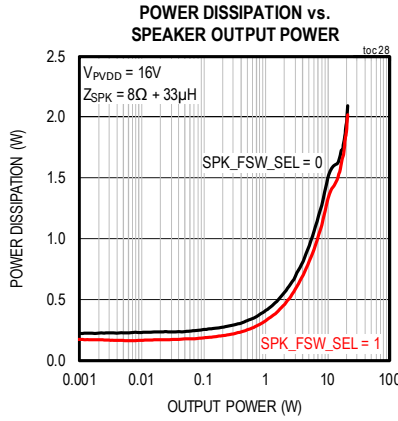
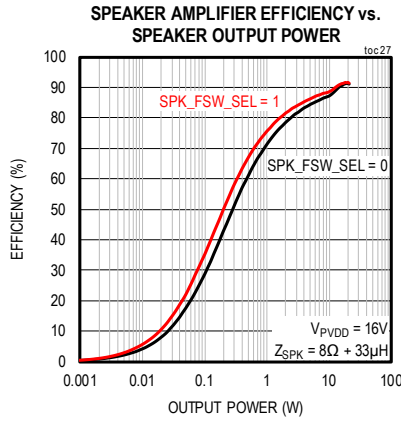

Typical Operating Characteristics (continued)

($V_{PVDD} = 12V$, $V_{DVDD} = 1.8V$, $AGND = DGND = PGND = 0V$, $C_{PVDD} = 2 \times 10\mu F + 2 \times 0.1\mu F + 1 \times 220\mu F$, $C_{DVDD} = 1\mu F$, $Z_{VREFC} = 10\mu F + 30\Omega$, $Z_{SPK} = \text{Open}$, $SPK_GAIN_MAX = 0x7$, $SPK_FSW_SEL = 0$, AC Measurement Bandwidth = 20Hz to 20kHz, PCM Interface, $f_S = 48kHz$, 24-bit data, $T_A = T_{MIN}$ to T_{MAX} . Typical values are at $T_A = +25^\circ C$.)

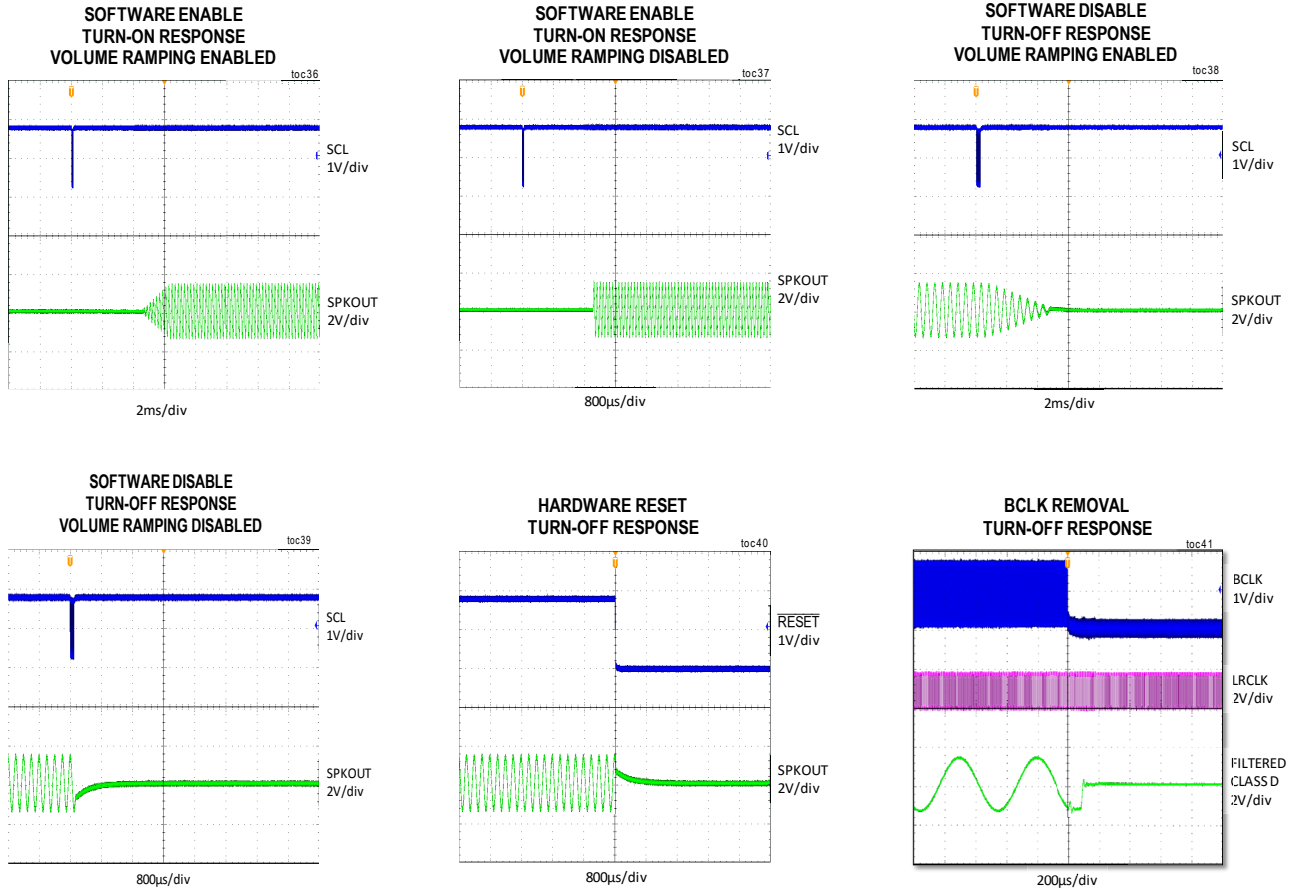

Typical Operating Characteristics (continued)

($V_{PVDD} = 12V$, $V_{DVDD} = 1.8V$, $AGND = DGND = PGND = 0V$, $C_{PVDD} = 2 \times 10\mu F + 2 \times 0.1\mu F + 1 \times 220\mu F$, $C_{DVDD} = 1\mu F$, $Z_{VREFC} = 10\mu F + 30\Omega$, $Z_{SPK} = \text{Open}$, $SPK_GAIN_MAX = 0x7$, $SPK_FSW_SEL = 0$, AC Measurement Bandwidth = 20Hz to 20kHz, PCM Interface, $f_S = 48kHz$, 24-bit data, $T_A = T_{MIN}$ to T_{MAX} . Typical values are at $T_A = +25^\circ C$.)

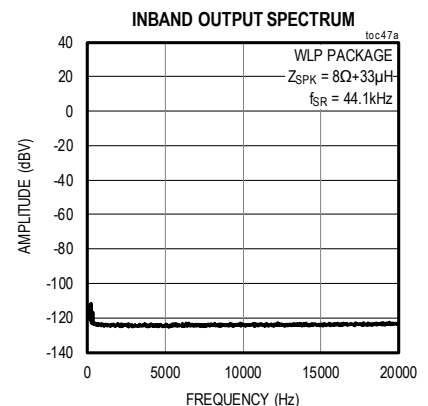
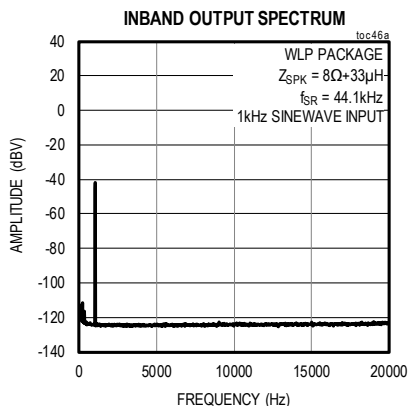
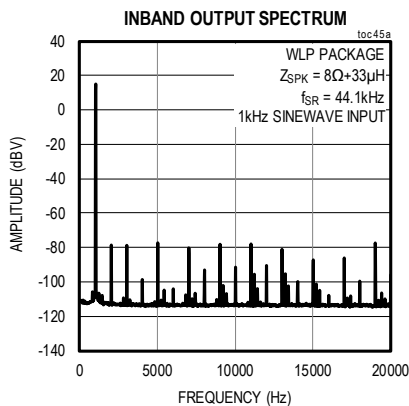
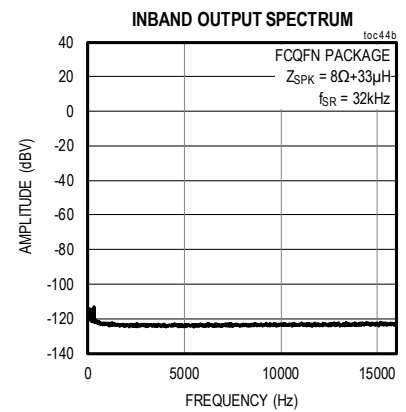
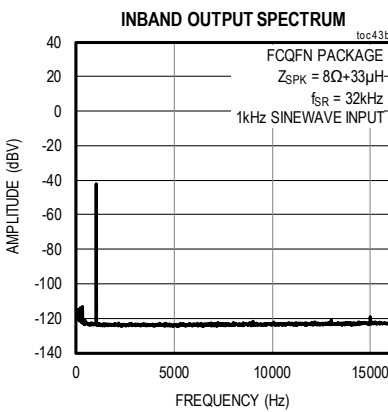
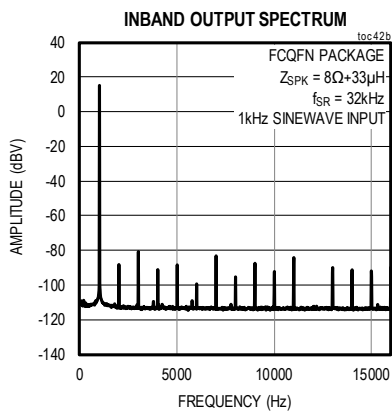
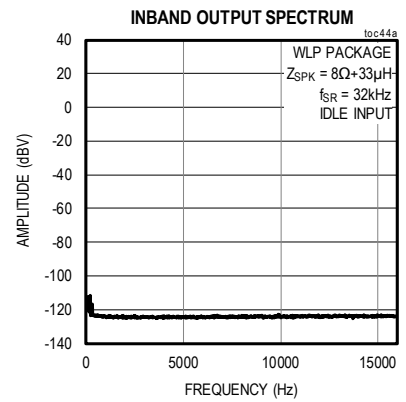
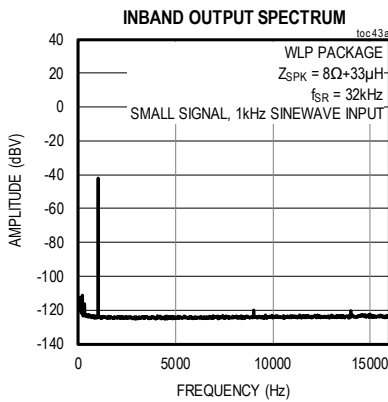
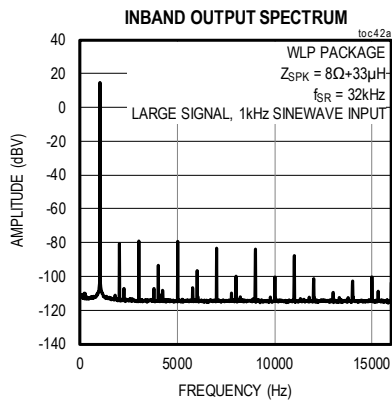

Typical Operating Characteristics (continued)

($V_{PVDD} = 12V$, $V_{DVDD} = 1.8V$, $AGND = DGND = PGND = 0V$, $C_{PVDD} = 2 \times 10\mu F + 2 \times 0.1\mu F + 1 \times 220\mu F$, $C_{DVDD} = 1\mu F$, $Z_{VREFC} = 10\mu F + 30\Omega$, $Z_{SPK} = \text{Open}$, $SPK_GAIN_MAX = 0x7$, $SPK_FSW_SEL = 0$, AC Measurement Bandwidth = 20Hz to 20kHz, PCM Interface, $f_S = 48kHz$, 24-bit data, $T_A = T_{MIN}$ to T_{MAX} . Typical values are at $T_A = +25^\circ C$.)

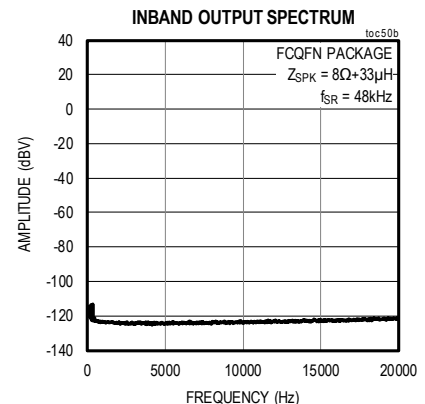
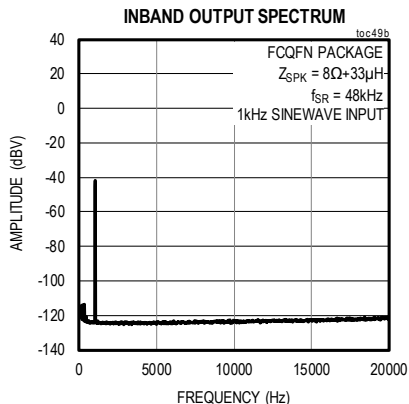
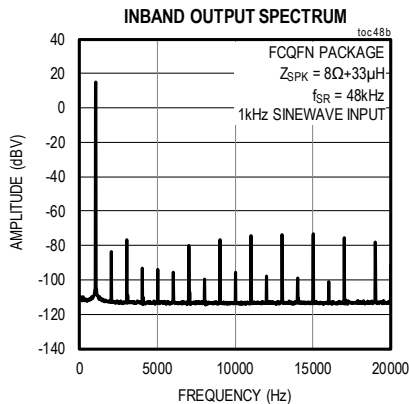
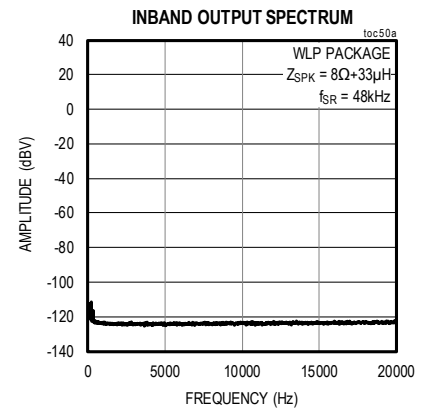
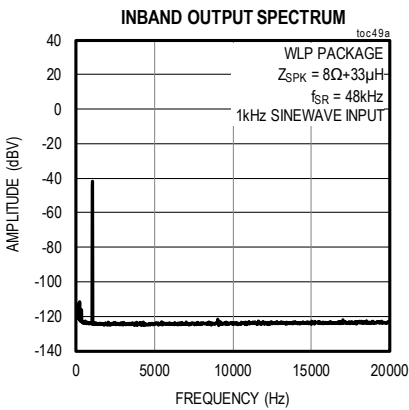
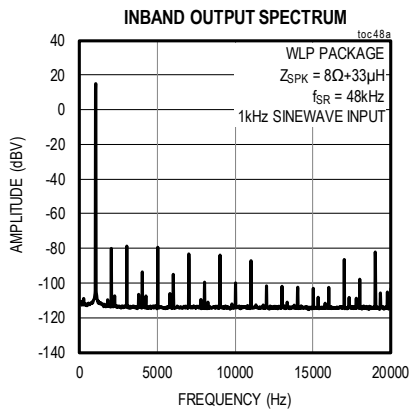
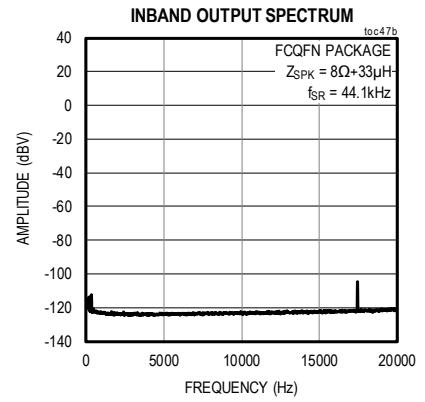
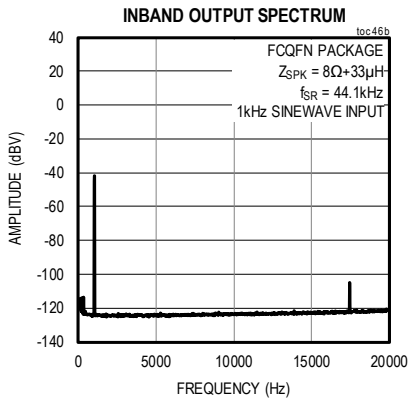
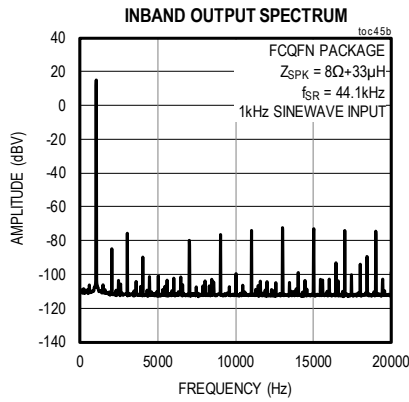

Typical Operating Characteristics (continued)

($V_{PVDD} = 12V$, $V_{DVDD} = 1.8V$, $AGND = DGND = PGND = 0V$, $C_{PVDD} = 2 \times 10\mu F + 2 \times 0.1\mu F + 1 \times 220\mu F$, $C_{DVDD} = 1\mu F$, $Z_{VREFC} = 10\mu F + 30\Omega$, $Z_{SPK} = \text{Open}$, $SPK_GAIN_MAX = 0x7$, $SPK_FSW_SEL = 0$, AC Measurement Bandwidth = 20Hz to 20kHz, PCM Interface, $f_S = 48kHz$, 24-bit data, $T_A = T_{MIN}$ to T_{MAX} . Typical values are at $T_A = +25^\circ C$.)

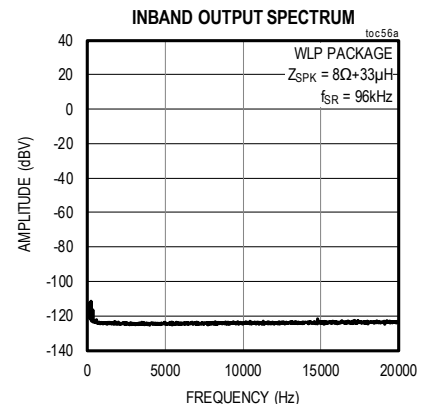
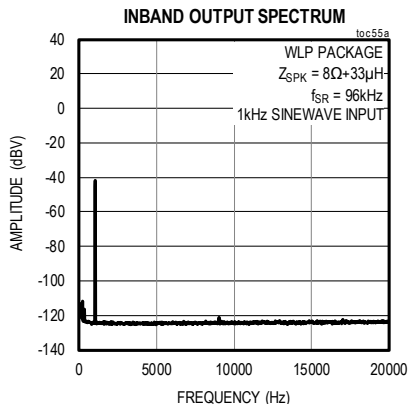
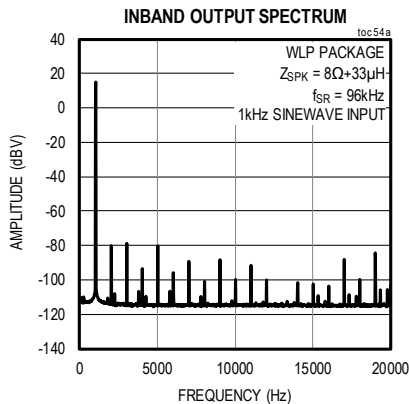
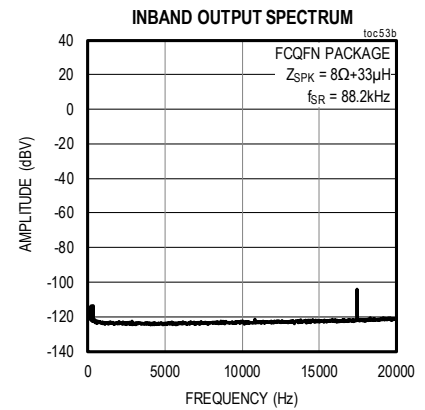
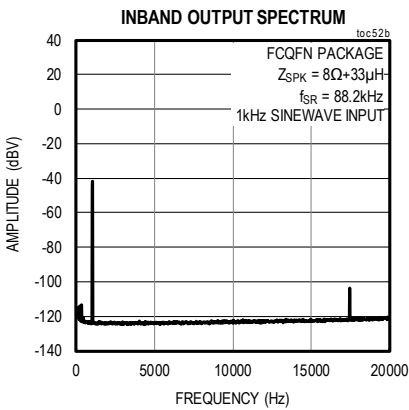
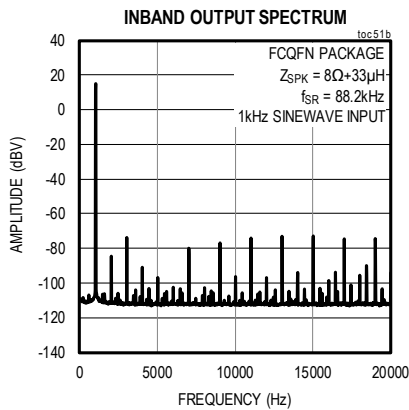
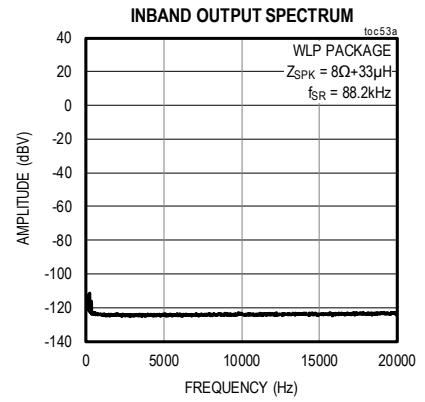
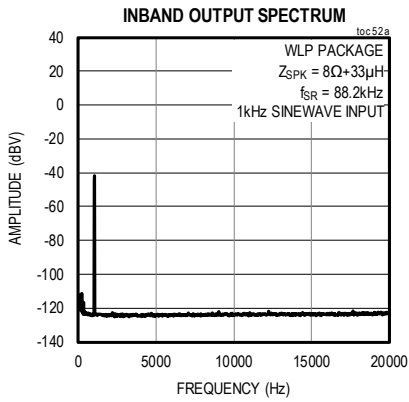
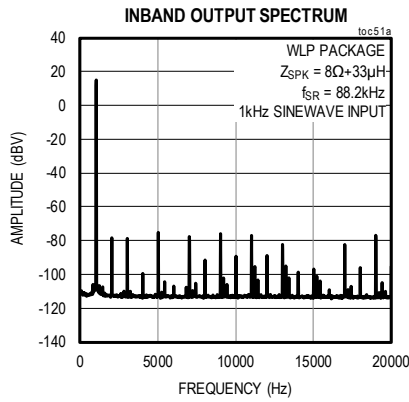

Typical Operating Characteristics (continued)

($V_{PVDD} = 12V$, $V_{DVDD} = 1.8V$, $AGND = DGND = PGND = 0V$, $C_{PVDD} = 2 \times 10\mu F + 2 \times 0.1\mu F + 1 \times 220\mu F$, $C_{DVDD} = 1\mu F$, $Z_{VREFC} = 10\mu F + 30\Omega$, $Z_{SPK} = \text{Open}$, $SPK_GAIN_MAX = 0x7$, $SPK_FSW_SEL = 0$, AC Measurement Bandwidth = 20Hz to 20kHz, PCM Interface, $f_S = 48kHz$, 24-bit data, $T_A = T_{MIN}$ to T_{MAX} . Typical values are at $T_A = +25^\circ C$.)

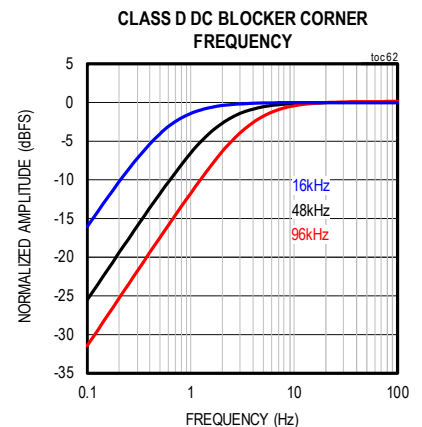
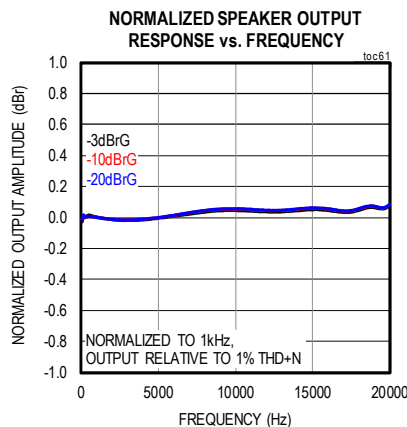
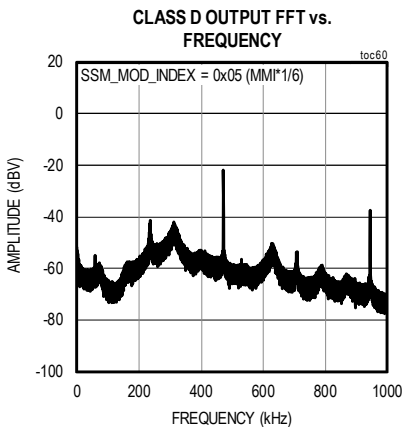
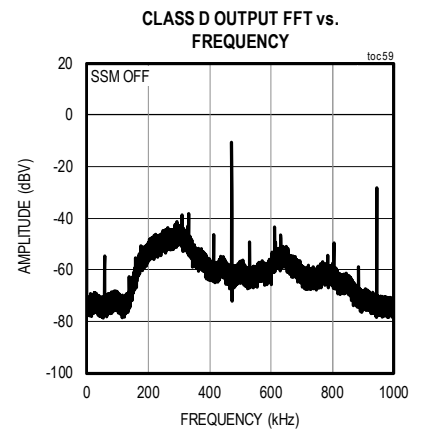
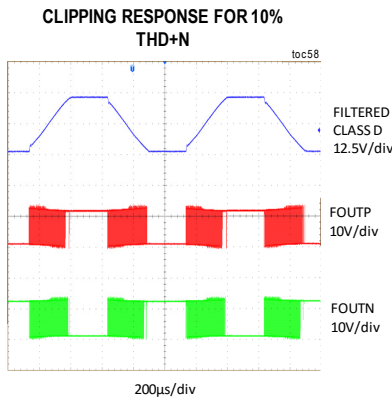
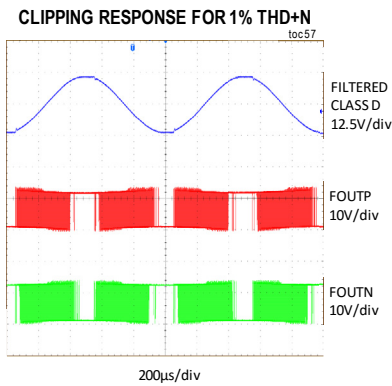
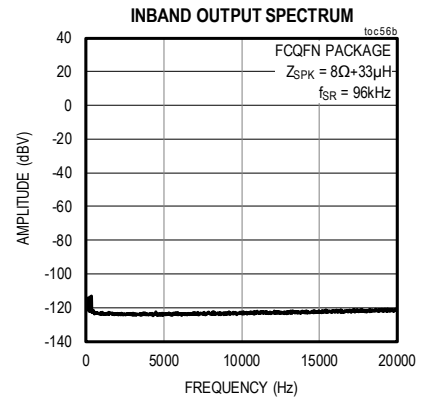
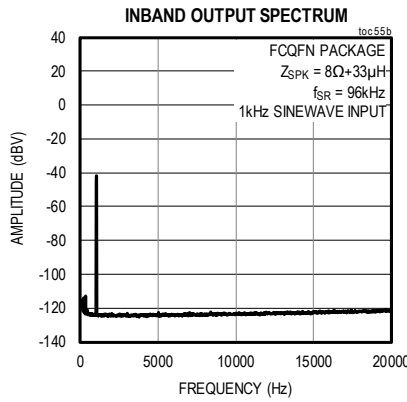
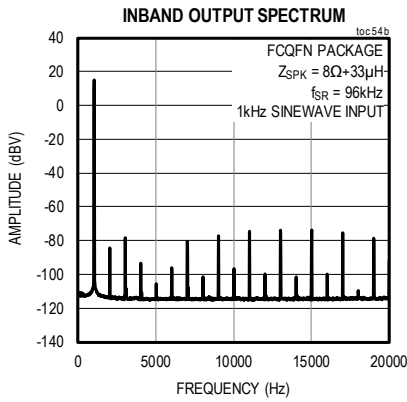

Pin Configuration (WLP)

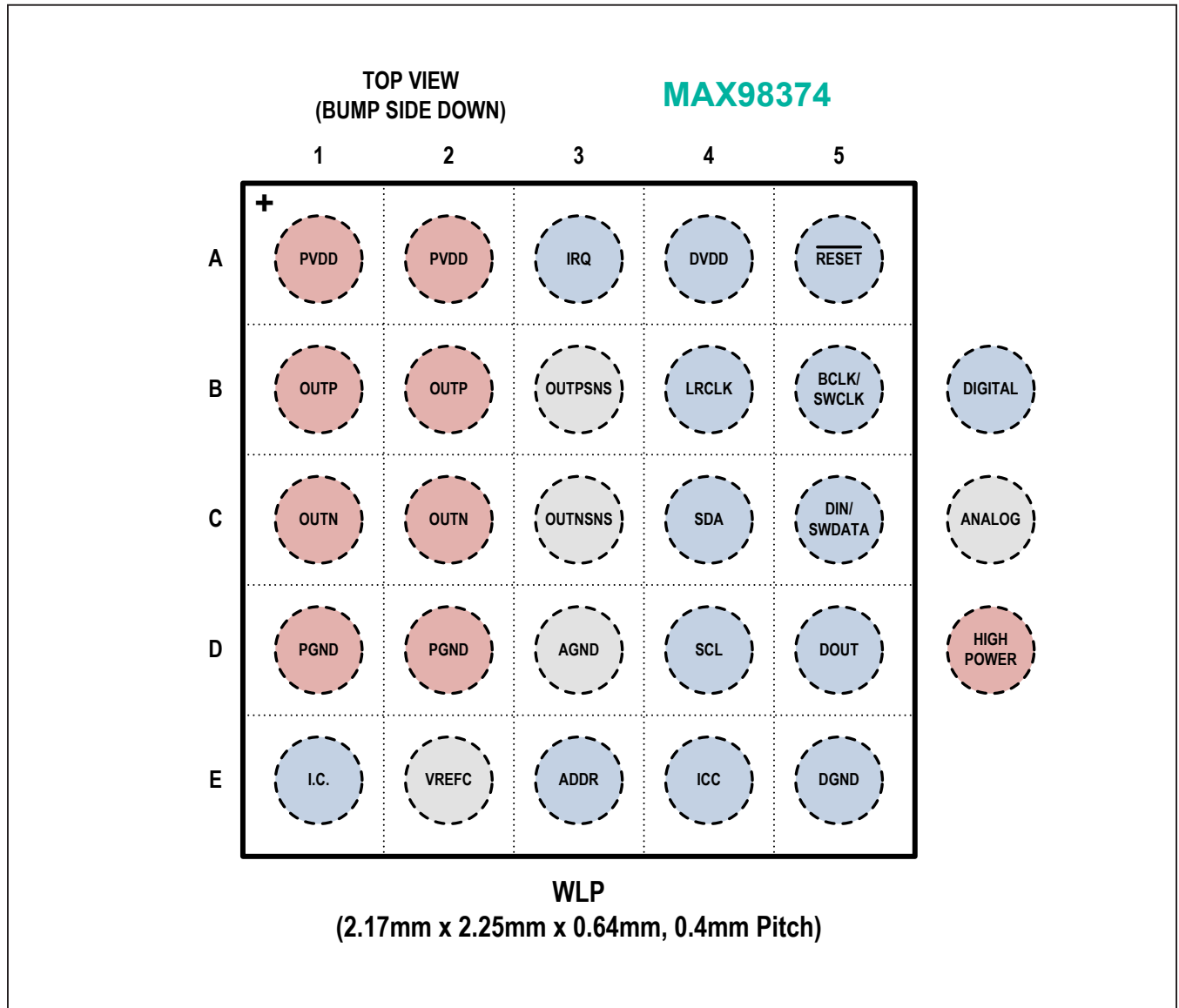

Pin Configuration (FCQFN)

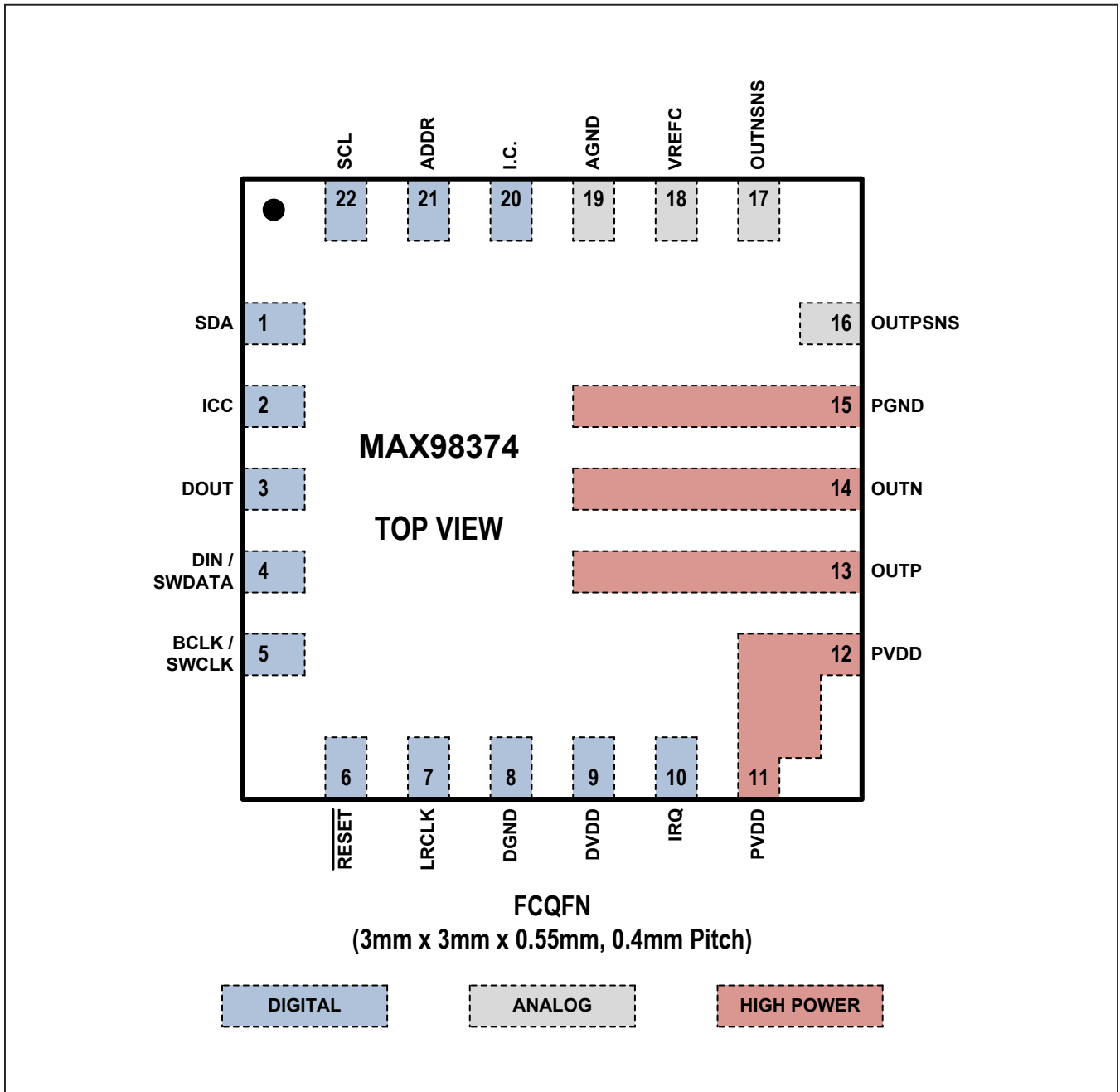

Pin Description

WLP	FCQFN	NAME	SUPPLY RAIL	FUNCTION
A1, A2	11, 12	PVDD	—	Speaker Amplifier Power Supply. Bypass each bump to PGND with a 0.1 μ F and 10 μ F capacitor (two of each total) placed as close as possible. Bypass the supply bus to PGND with a single 220 μ F bulk capacitor per device.
A3	10	IRQ	DVDD	Hardware Interrupt Output. Interrupt polarity and pin drive mode are configurable. Connect a 1.5k Ω pullup resistor to DVDD for full logic level swing in open-drain mode.
A4	9	DVDD	—	Digital Power Supply. Power supply for the digital core and digital interface pins. Bypass to DGND with 1 μ F capacitor.
A5	6	$\overline{\text{RESET}}$	DVDD	Active-Low Hardware Reset. Resets all digital portions of the device and all registers to default PoR settings. DVDD must be in the valid operating range before driving high. Do not connect directly to DVDD.
B1, B2	13	OUTP	PVDD	Positive Speaker Amplifier Output
B3	16	OUTPSNS	PVDD	Speaker Amplifier Feedback Positive Input. Connect as close as possible to the positive terminal of the loudspeaker. This pin must form a complete loop with OUTP.
B4	7	LRCLK	DVDD	PCM Interface Frame Clock Input. LRCLK frequency matches the PCM interface sample rate. Internally pulled down to DGND through R _{PD} .
B5	5	BCLK/ SWCLK	DVDD	PCM Interface Bit Clock Input/SoundWire Compatible Interface Clock Input. Internally pulled down to DGND through R _{PD} .
C1, C2	14	OUTN	PVDD	Negative Speaker Amplifier Output
C3	17	OUTNSNS	PVDD	Speaker Amplifier Feedback Negative Input. Connect as close as possible to the negative terminal of the loudspeaker. This pin must form a complete loop with OUTN.
C4	1	SDA	DVDD	I ² C-Compatible Serial-Data. Connect a 1.5k Ω pullup resistor to DVDD for full logic level swing. In SoundWire control mode, connect to either DVDD or DGND.
C5	4	DIN/ SWDATA	DVDD	PCM Interface Data Input/SoundWire Compatible Interface Data Bus. Internally pulled down to DGND through R _{IN} .
D1, D2	15	PGND	—	Speaker Amplifier Ground
D3	19	AGND	—	Analog Ground. Connecting AGND to PGND on the top layer of the PCB is not recommended.
D4	22	SCL	DVDD	I ² C-Compatible Serial-Clock. Connect a 1.5k Ω pullup resistor to DVDD for full logic level swing. In SoundWire control mode, connect to either DVDD or DGND.
D5	3	DOUT	DVDD	PCM Interface Data Output
E1	20	I.C.	DVDD	Internally Connected. Connect to DVDD externally. Do not connect to ground or leave unconnected.
E2	18	V _{REFC}	PVDD	Internal Bias. Bypass to AGND with a 30 Ω resistor and a 10 μ F capacitor.
E3	21	ADDR	DVDD	I ² C Slave Address Select. Selects one of four I ² C slave addresses.
E4	2	ICC	DVDD	Interchip Communication Data Bus. Optionally allows multiple devices to be grouped up to communicate with each other in order to provide a consistent response. Internally pulled down to DGND by R _{PD} .
E5	8	DGND	—	Digital Ground

Detailed Description

Control Interface Configuration

The device features a SoundWire compatible slave interface, an I²C slave interface, and a PCM audio interface (Figure 9). After initially powering up both supplies or when exiting hardware shutdown, the device control mode defaults to the SoundWire compatible interface. In this control mode, the SoundWire Compatible interface is used to program all device registers and for all digital audio data communication. In SoundWire control mode, the device I²C interface bus connections cannot be shared with another device, and the ADDR, SDA, and

SCL pins must each be connected to either DVDD or DGND to configure the SoundWire ID (Table 14).

Any time after initial power-up, if the device is not in hardware shutdown and an I²C start condition is detected, the device automatically switches to I²C control mode. The I²C start condition that causes the switch over can be part of a normal I²C transaction. In I²C control mode, the I²C interface is used to program the general control registers while the PCM interface is used for all digital audio data communication. Once the device is in I²C control mode, only a full supply power cycle or hardware shutdown event can return the device to SoundWire control mode.

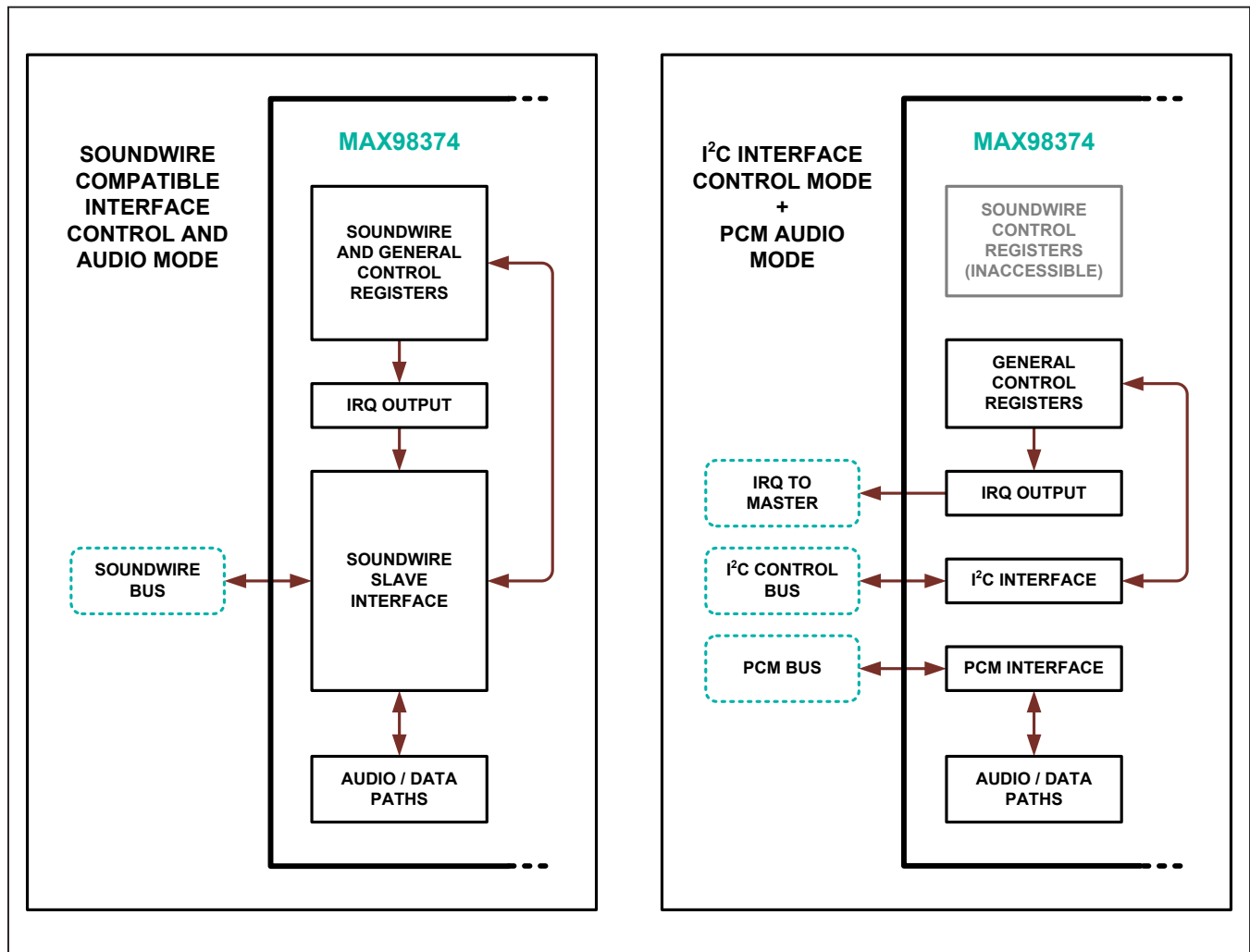

Figure 9. Control Interface Configuration Options

Device Register Map

The general control registers in the address space 0x2000 and above are accessible through both the SoundWire compatible and I²C interface and are used for configuring the device (except the SoundWire compatible interface). The registers in the address space 0x0040 to 0x0337 are only accessible through the SoundWire compatible interface and are used for configuring the SoundWire slave interface settings (Figure 9). Register bit fields come in several varieties that are summarized and color coded in Table 1.

Read-only bit fields (R) are used to indicate an internal device state and cannot be changed directly by the host. Writing to these registers has no effect. Read-only status

bit fields are the same, however, writing a 1 to these registers clears the status while writing a 0 has no effect.

Write-only bit fields (W) are single-bit push-button controls. Writing a 1 to these bit fields performs an action (i.e., software reset, interrupt clear, etc.). Writing a 0 has no effect and readback always returns a 0.

Read/write bit fields (RW) can be both read and written by the host, and the last written value is the value returned on read back.

Reserved bit fields (indicated by a “—” in Table 2) are not used to program or control the device. When writing a register that contains reserved bit fields, always write a 0 to the reserved bit field segments.

Table 1. Register Map Bit Field Color Coding

BIT FIELD TYPE	FUNCTIONAL DESCRIPTION
Read-Only Bit Field	A write to a read-only bit field has no effect.
Read-Only Status Bit Field (Clear on Write)	Write a 1 to clear a read-only status bit field. A write of 0 has no effect.
Write-Only Bit Field	Write a 1 to activate the function of a write-only bit field. A write of 0 has no effect, and readback always returns 0.
Read/Write Bit Field	Read and write commands function normally. There can be write access restrictions.
Reserved Bit Field	Always write a 0 to a reserved bit field.

Table 2. General Control Register Map

REGISTER PROPERTIES			REGISTER CONTENTS							
ADDR	POR	REGISTER NAME	BIT 7	BIT 6	BIT 5	BIT 4	BIT 3	BIT 2	BIT 1	BIT 0
SOFTWARE RESET REGISTER										
0x2000	0x00	Software Reset	—	—	—	—	—	—	—	RST
INTERRUPT REGISTERS										
0x2001	0x00	Interrupt Raw 1	THERMSHDN_BGN_RAW	THERMSHDN_END_RAW	THERMWARN_BGN_RAW	THERMWARN_END_RAW	BDE_L4_RAW	BDE_LEVEL_RAW	BDE_ACTIVE_BGN_RAW	BDE_ACTIVE_END_RAW
0x2002	0x00	Interrupt Raw 2	PWRUP_DONE_RAW	PWRDN_DONE_RAW	OTP_FAIL_RAW	SPK_OVC_RAW	CLKSTART_RAW	CLKSTOP_RAW	ICC_SYNC_ERR_RAW	ICC_DATA_ERR_RAW
0x2003	0x00	Interrupt Raw 3	PVDD_UVLO_SHDN_RAW	—	THERMFB_BGN_RAW	THERMFB_END_RAW	DHT_ACTIVE_BGN_RAW	DHT_ACTIVE_END_RAW	LMTR_ACTIVE_BGN_RAW	LMTR_ACTIVE_END_RAW
0x2004	0x00	Interrupt State 1	THERMSHDN_BGN_STATE	THERMSHDN_END_STATE	THERMWARN_BGN_STATE	THERMWARN_END_STATE	BDE_L4_STATE	BDE_LEVEL_STATE	BDE_ACTIVE_BGN_STATE	BDE_ACTIVE_END_STATE
0x2005	0x00	Interrupt State 2	PWRUP_DONE_STATE	PWRDN_DONE_STATE	OTP_FAIL_STATE	SPK_OVC_STATE	CLKSTART_STATE	CLKSTOP_STATE	ICC_SYNC_ERR_STATE	ICC_DATA_ERR_STATE
0x2006	0x00	Interrupt State 3	PVDD_UVLO_SHDN_STATE	—	THERMFB_BGN_STATE	THERMFB_END_STATE	DHT_ACTIVE_BGN_STATE	DHT_ACTIVE_END_STATE	LMTR_ACTIVE_BGN_STATE	LMTR_ACTIVE_END_STATE
0x2007	0x00	Interrupt Flag 1	THERMSHDN_BGN_FLAG	THERMSHDN_END_FLAG	THERMWARN_BGN_FLAG	THERMWARN_END_FLAG	BDE_L4_FLAG	BDE_LEVEL_FLAG	BDE_ACTIVE_BGN_FLAG	BDE_ACTIVE_END_FLAG
0x2008	0x00	Interrupt Flag 2	PWRUP_DONE_FLAG	PWRDN_DONE_FLAG	OTP_FAIL_FLAG	SPK_OVC_FLAG	CLKSTART_FLAG	CLKSTOP_FLAG	ICC_SYNC_ERR_FLAG	ICC_DATA_ERR_FLAG
0x2009	0x00	Interrupt Flag 3	PVDD_UVLO_SHDN_FLAG	—	THERMFB_BGN_FLAG	THERMFB_END_FLAG	DHT_ACTIVE_BGN_FLAG	DHT_ACTIVE_END_FLAG	LMTR_ACTIVE_BGN_FLAG	LMTR_ACTIVE_END_FLAG
0x200A	0x00	Interrupt Enable 1	THERMSHDN_BGN_EN	THERMSHDN_END_EN	THERMWARN_BGN_EN	THERMWARN_END_EN	BDE_L4_EN	BDE_LEVEL_EN	BDE_ACTIVE_BGN_EN	BDE_ACTIVE_END_EN
0x200B	0x00	Interrupt Enable 2	PWRUP_DONE_EN	PWRDN_DONE_EN	OTP_FAIL_EN	SPK_OVC_EN	CLKSTART_EN	CLKSTOP_EN	ICC_SYNC_ERR_EN	ICC_DATA_ERR_EN
0x200C	0x00	Interrupt Enable 3	PVDD_UVLO_SHDN_EN	—	THERMFB_BGN_EN	THERMFB_END_EN	DHT_ACTIVE_BGN_EN	DHT_ACTIVE_END_EN	LMTR_ACTIVE_BGN_EN	LMTR_ACTIVE_END_EN
0x200D	0x00	Interrupt Flag Clear 1	THERMSHDN_BGN_CLR	THERMSHDN_END_CLR	THERMWARN_BGN_CLR	THERMWARN_END_CLR	BDE_L4_CLR	BDE_LEVEL_CLR	BDE_ACTIVE_BGN_CLR	BDE_ACTIVE_END_CLR
0x200E	0x00	Interrupt Flag Clear 2	PWRUP_DONE_CLR	PWRDN_DONE_CLR	OTP_FAIL_CLR	SPK_OVC_CLR	CLKSTART_CLR	CLKSTOP_CLR	ICC_SYNC_ERR_CLR	ICC_DATA_ERR_CLR
0x200F	0x00	Interrupt Flag Clear 3	PVDD_UVLO_SHDN_CLR	—	THERMFB_BGN_CLR	THERMFB_END_CLR	DHT_ACTIVE_BGN_CLR	DHT_ACTIVE_END_CLR	LMTR_ACTIVE_BGN_CLR	LMTR_ACTIVE_END_CLR
0x2010	0x00	IRQ Bus Configuration	—	—	—	—	—	IRQ_MODE	IRQ_POL	IRQ_EN
THERMAL PROTECTION REGISTERS										
0x2014	0x10	Thermal-Warning Threshold Configuration	—	—	THERMWARN_THRESH[5:0]					
0x2015	0x27	Thermal-Shutdown Threshold Configuration	—	—	THERMSHDN_THRESH[5:0]					

Table 2. General Control Register Map (continued)

REGISTER PROPERTIES			REGISTER CONTENTS							
ADDR	POR	REGISTER NAME	BIT 7	BIT 6	BIT 5	BIT 4	BIT 3	BIT 2	BIT 1	BIT 0
0x2016	0x01	Thermal Hysteresis Configuration	—	—	—	—	—	—	THERM_HYST[1:0]	
0x2017	0xC0	Thermal-Foldback Settings	THERMFB_HOLD[1:0]		—	—	THERMFB_RLS[1:0]		THERMFB_SLOPE[1:0]	
0x2018	0x00	Thermal-Foldback Enable	—	—	—	—	—	—	—	THERMFB_EN
PCM INTERFACE REGISTERS										
0x201E	0x55	Digital Output Pin Drive Strength Configuration	ICC_DRV[1:0]		LRCLK_DRV[1:0]		IRQ_DRV[1:0]		DOUT_DRV[1:0]	
0x2020	0xFE	PCM Interface Data Output Channel Configuration 1	PCM_TX_CH7_HIZ	PCM_TX_CH6_HIZ	PCM_TX_CH5_HIZ	PCM_TX_CH4_HIZ	PCM_TX_CH3_HIZ	PCM_TX_CH2_HIZ	PCM_TX_CH1_HIZ	PCM_TX_CH0_HIZ
0x2021	0xFF	PCM Interface Data Output Channel Configuration 2	PCM_TX_CH15_HIZ	PCM_TX_CH14_HIZ	PCM_TX_CH13_HIZ	PCM_TX_CH12_HIZ	PCM_TX_CH11_HIZ	PCM_TX_CH10_HIZ	PCM_TX_CH9_HIZ	PCM_TX_CH8_HIZ
0x2023	0x00	PCM Interface Data Output Speaker DSP Feedback Channel Source	—	—	—	—	PCM_SPK_FB_DEST[3:0]			
0x2024	0xC0	PCM Interface Data Format Configuration	PCM_DATA_WIDTH[1:0]		PCM_FORMAT[2:0]			PCM_TX_INTERLEAVE	PCM_CHANSEL	PCM_TX_EXTRA_HIZ
0x2025	0x00	Audio Interface Mode Configuration	—	—	—	—	—	—	INTERFACE_MODE[1:0]	
0x2026	0x04	PCM Interface Clock Ratio Configuration	—	—	—	PCM_BCLKEDGE	PCM_BSEL[3:0]			
0x2027	0x08	PCM Interface Sample Rate	—	—	—	—	PCM_SR[3:0]			
0x2028	0x88	Speaker Path Sample Rate	SPK_SR[3:0]				—	—	—	—
0x2029	0x00	PCM Interface Digital Mono Mixer Configuration 1	DMMIX_CFG[1:0]		—	—	DMMIX_CH0_SOURCE[3:0]			
0x202A	0x00	PCM Interface Digital Mono Mixer Configuration 2	—	—	—	—	DMMIX_CH1_SOURCE[3:0]			
0x202B	0x00	PCM Interface Data Input (DIN) Enable	—	—	—	—	—	—	—	PCM_RX_EN
0x202C	0x00	PCM Interface Data Output (DOUT) Enable	—	—	—	—	—	—	—	PCM_TX_EN

Table 2. General Control Register Map (continued)

REGISTER PROPERTIES			REGISTER CONTENTS							
ADDR	POR	REGISTER NAME	BIT 7	BIT 6	BIT 5	BIT 4	BIT 3	BIT 2	BIT 1	BIT 0
ICC REGISTERS										
0x202E	0x00	ICC Receiver Enables 1	ICC_RX_CH7_EN	ICC_RX_CH6_EN	ICC_RX_CH5_EN	ICC_RX_CH4_EN	ICC_RX_CH3_EN	ICC_RX_CH2_EN	ICC_RX_CH1_EN	ICC_RX_CH0_EN
0x202F	0x00	ICC Receiver Enables 2	ICC_RX_CH15_EN	ICC_RX_CH14_EN	ICC_RX_CH13_EN	ICC_RX_CH12_EN	ICC_RX_CH11_EN	ICC_RX_CH10_EN	ICC_RX_CH9_EN	ICC_RX_CH8_EN
0x2030	0xFF	ICC Transmitter Channel Configuration 1	ICC_TX_CH7_HIZ	ICC_TX_CH6_HIZ	ICC_TX_CH5_HIZ	ICC_TX_CH4_HIZ	ICC_TX_CH3_HIZ	ICC_TX_CH2_HIZ	ICC_TX_CH1_HIZ	ICC_TX_CH0_HIZ
0x2031	0xFF	ICC Transmitter Channel Configuration 2	ICC_TX_CH15_HIZ	ICC_TX_CH14_HIZ	ICC_TX_CH13_HIZ	ICC_TX_CH12_HIZ	ICC_TX_CH11_HIZ	ICC_TX_CH10_HIZ	ICC_TX_CH9_HIZ	ICC_TX_CH8_HIZ
0x2032	0x30	ICC Data Link Configuration	ICC_DHT_CONFIG	ICC_LIM_CONFIG	ICC_BDE_CONFIG	ICC_THERM_CONFIG	ICC_DHT_LINK_EN	ICC_LIM_LINK_EN	ICC_BDE_LINK_EN	ICC_THERM_LINK_EN
0x2034	0x00	ICC Transmitter Configuration	ICC_SYNC_SLOT[3:0]				ICC_TX_DEST[3:0]			
0x2035	0x00	ICC Transmitter Enable	—	—	—	—	—	—	—	ICC_TX_EN
SOUNDWIRE SLAVE INTERFACE REGISTERS										
0x2036	0x05	SoundWire Input Clock Configuration	—	—	—	SWIRE_CLK_RATE[1:0]		SWIRE_CLK_SEL[2:0]		
SPEAKER PATH CONTROL REGISTERS										
0x203D	0x00	Speaker Path Digital Volume Control	—	SPK_VOL[6:0]						
0x203E	0x08	Speaker Path Output Level Scaling	SPK_GAIN[3:0]				SPK_GAIN_MAX[3:0]			
0x203F	0x02	Speaker Path DSP Configuration	SPK_VOL_SEL	—	SPK_INVERT	—	SPK_VOL_RMPDN_BYPASS	SPK_VOL_RMPUP_BYPASS	SPK_DITH_EN	SPK_DCBLK_EN
0x2040	0x00	Tone Generator Configuration	—	—	—	—	TONE_CONFIG[3:0]			
0x2041	0x03	Speaker Amplifier Configuration	SPK_SSM_EN	SPK_OSC_SEL	—	—	SPK_FSW_SEL	SPK_SSM_MOD_INDEX[2:0]		
0x2042	0x00	Speaker Amplifier Switching Edge Rate Configuration	—	—	—	—	—	SPK_EDGE_CTRL[1:0]		—
0x2043	0x00	Speaker Path and Speaker DSP Data Feedback Path Enables	—	—	—	—	—	—	SPK_FB_EN	SPK_EN

Table 2. General Control Register Map (continued)

REGISTER PROPERTIES			REGISTER CONTENTS							
ADDR	POR	REGISTER NAME	BIT 7	BIT 6	BIT 5	BIT 4	BIT 3	BIT 2	BIT 1	BIT 0
MEASUREMENT ADC REGISTERS										
0x2051	0x00	Measurement ADC Sample Rate Control	—	—	—	—	—	—	—	MEAS_ADC_SR[1:0]
0x2052	0x00	Measurement ADC PVDD Channel Filter Configuration	—	—	—	MEAS_ADC_PVDD_FILTER_EN	—	—	—	MEAS_ADC_PVDD_FILTER_COEFF[1:0]
0x2053	0x00	Measurement ADC Thermal Channel Filter Configuration	—	—	—	MEAS_ADC_TEMP_FILTER_EN	—	—	—	MEAS_ADC_TEMP_FILTER_COEFF[1:0]
0x2054	0x00	Measurement ADC PVDD Channel Readback	MEAS_ADC_PVDD_DATA[7:0]							
0x2055	0x00	Measurement ADC Thermal Channel Readback	MEAS_ADC_THERM_DATA[7:0]							
0x2056	0x00	Measurement ADC PVDD Channel Enable	—	—	—	—	—	—	—	MEAS_ADC_PVDD_EN
BDE REGISTERS										
0x2090	0x00	BDE Level Hold Time	BDE_HLD[7:0]							
0x2091	0x00	BDE Gain Reduction Attack/Release Rates	BDE_GAIN_ATK[3:0]				BDE_GAIN_RLS[3:0]			
0x2092	0x00	BDE Clipper Mode	—	—	—	—	—	—	—	BDE_CLIP_MODE
0x2097	0x00	BDE Level 1 Threshold	BDE_L1_VTHRESH[7:0]							
0x2098	0x00	BDE Level 2 Threshold	BDE_L2_VTHRESH[7:0]							
0x2099	0x00	BDE Level 3 Threshold	BDE_L3_VTHRESH[7:0]							
0x209A	0x00	BDE Level 4 Threshold	BDE_L4_VTHRESH[7:0]							
0x209B	0x00	BDE Level Threshold Hysteresis	BDE_VTHRESH_HYST[7:0]							
0x20A8	0x00	BDE Level 1 Limiter Configuration	—	—	—	—	BDE_L1_LIM[3:0]			
0x20A9	0x00	BDE Level 1 Clipper Configuration	—	—	BDE_L1_CLIP[5:0]					
0x20AA	0x00	BDE Level 1 Gain Reduction Configuration	—	—	BDE_L1_GAIN[5:0]					
0x20AB	0x00	BDE Level 2 Limiter Configuration	—	—	—	—	BDE_L2_LIM[3:0]			

Table 2. General Control Register Map (continued)

REGISTER PROPERTIES			REGISTER CONTENTS								
ADDR	POR	REGISTER NAME	BIT 7	BIT 6	BIT 5	BIT 4	BIT 3	BIT 2	BIT 1	BIT 0	
0x20AC	0x00	BDE Level 2 Clipper Configuration	—	—	BDE_L2_CLIP[5:0]						
0x20AD	0x00	BDE Level 2 Gain Reduction Configuration	—	—	BDE_L2_GAIN[5:0]						
0x20AE	0x00	BDE Level 3 Limiter Configuration	—	—	—	—	BDE_L3_LIM[3:0]				
0x20AF	0x00	BDE Level 3 Clipper Configuration	—	—	BDE_L3_CLIP[5:0]						
0x20B0	0x00	BDE Level 3 Gain Reduction Configuration	—	—	BDE_L3_GAIN[5:0]						
0x20B1	0x00	BDE Level 4 Limiter Configuration	—	—	—	—	BDE_L4_LIM[3:0]				
0x20B2	0x00	BDE Level 4 Clipper and State Configuration	BDE_L4_MUTE	BDE_L4_INF_HLD	BDE_L4_CLIP[5:0]						
0x20B3	0x00	BDE Level 4 Gain Reduction Configuration	—	—	BDE_L4_GAIN[5:0]						
0x20B4	0x00	BDE Level 4 Infinite Hold Clear	BDE_L4_HLD_RLS	—	—	—	—	—	—	—	
0x20B5	0x00	BDE Enable	—	—	—	—	—	—	—	BDE_EN	
0x20B6	0x00	BDE Current State	—	—	—	—	BDE_STATE[3:0]				
DHT REGISTERS											
0x20D1	0x01	DHT Configuration	DHT_SPK_GAIN_MIN[3:0]				DHT_VROT_PNT[3:0]				
0x20D2	0x02	DHT Attack Rate Settings	—	—	—	DHT_ATK_STEP[1:0]		DHT_ATK_RATE[2:0]			
0x20D3	0x03	DHT Release Rate Settings	—	—	—	DHT_RLS_STEP[1:0]		DHT_RLS_RATE[2:0]			
0x20D4	0x00	DHT Enable	—	—	—	—	—	—	—	DHT_EN	
LIMITER REGISTERS											
0x20E0	0x00	Limiter Threshold Configuration	—	LIM_THRESH[4:0]						—	—
0x20E1	0x00	Limiter Attack and Release Rate Configuration	LIM_ATK_RATE[3:0]				LIM_RLS_RATE[3:0]				
0x20E2	0x00	Limiter Enable	—	—	—	—	—	—	—	LIM_EN	
ENABLE REGISTERS											
0x20FE	0x00	Device Auto-Restart Configuration	—	—	—	—	OVC_AUTO_RESTART_EN	THERM_AUTO_RESTART_EN	CMON_AUTO_RESTART_EN	CMON_EN	
0x20FF	0x00	Global Enable	—	—	—	—	—	—	—	EN	
REVISION IDENTIFICATION REGISTER											
0x21FF	0x43	Device Revision Identification Number	REV_ID[7:0]								

Table 3. SoundWire Slave Interface Register Map

REGISTER PROPERTIES			REGISTER CONTENTS							
ADDR	POR	NAME	BIT 7	BIT 6	BIT 5	BIT 4	BIT 3	BIT 2	BIT 1	BIT 0
SLAVE CONTROL PORT (SCP) REGISTERS										
0x0040	0x00	SCP_IntStat_1	SCP2 Cascade	Port 3 Cascade	Port 2 Cascade	Port 1 Cascade	—	IntStat ImpDef1	IntStat Port Ready	IntStat Parity
0x0041	0x00	SCP_IntMask_1	—	—	—	—	—	IntMask ImpDef1	IntMask Bus Clash	intMask Parity
0x0042	0x00	SCP_IntStat_2	—	—	—	—	—	—	—	Port 4 Cascade
0x0044	0x00	SCP_Ctrl	ForceReset	CurrentBank	—	—	—	—	ClockStop Now	ClockStop NotFinished
0x0045	0x00	SCP_SystemCtrl	—	—	—	—	—	—	—	ClockStop Prepare
0x0046	0x00	SCP_DevNumber	—	—	Group_ID[1:0]		Device Number[3:0]			
0x0050	0x21	SCP_DevId_0	Device_ID[47:40]							
0x0051	0x01	SCP_DevId_1	Device ID[39:32]							
0x0052	0x9F	SCP_DevId_2	Device ID[31:24]							
0x0053	0x87	SCP_DevId_3	Device ID[23:16]							
0x0054	0x08	SCP_DevId_4	Device ID[15:8]							
0x0055	0x00	SCP_DevId_5	Device ID[7:0]							
0x0060	0x00	SCP_FrameCtrl	RowControl[4:0]				ColumnControl[2:0]			
0x0070	0x00	SCP_FrameCtrl	RowControl[4:0]				ColumnControl[2:0]			
DATA PORT 1 REGISTERS										
0x0100	0x00	DP1_IntStat	—	—	—	—	—	—	IntStat Port Ready	IntStat Test Fail
0x0101	0x00	DP1_IntMask	—	—	—	—	—	—	IntMask Port Ready	IntMask Test Fail
0x0102	0x20	DP1_PortCtrl	—	—	Port Direction	Next InvertBank	PortDataMode[1:0]		PortFlowMode[1:0]	
0x0103	0x00	DP1_BlockCtrl1	—	—	—	WordLength[4:0]				
0x0104	0x00	DP1_PrepareStatus	—	—	—	—	—	—	N-Finished Channel 2	N-Finished Channel 1
0x0105	0x00	DP1_PrepareCtrl	—	—	—	—	—	—	Prepare Channel 2	Prepare Channel 1
DATA PORT 1 - BANK 0 REGISTERS										
0x0120	0x00	DP1_ChannelEn	—	—	—	—	—	—	Enable Channel 2	Enable Channel 1
0x0122	0x00	DP1_SampleCtrl1	SampleIntervalLow[7:0]							
0x0123	0x00	DP1_SampleCtrl2	SampleIntervalHigh[7:0]							
0x0124	0x00	DP1_OffsetCtrl1	Offset1[7:0]							
0x0125	0x00	DP1_OffsetCtrl2	Offset2[7:0]							
0x0126	0x00	DP1_HCtrl	HStart[3:0]				HStop[3:0]			
0x0127	0x00	DP1_BlockCtrl3	—	—	—	—	—	—	—	BlockPacking Mode

Table 3. SoundWire Slave Interface Register Map (continued)

REGISTER PROPERTIES			REGISTER CONTENTS							
ADDR	POR	NAME	BIT 7	BIT 6	BIT 5	BIT 4	BIT 3	BIT 2	BIT 1	BIT 0
DATA PORT 1 - BANK 1 REGISTERS										
0x0130	0x00	DP1_ChannelEn	—	—	—	—	—	—	Enable Channel 2	Enable Channel 1
0x0132	0x00	DP1_SampleCtrl1	SampleIntervalLow[7:0]							
0x0133	0x00	DP1_SampleCtrl2	SampleIntervalHigh[7:0]							
0x0134	0x00	DP1_OffsetCtrl1	Offset1[7:0]							
0x0135	0x00	DP1_OffsetCtrl2	Offset2[7:0]							
0x0136	0x00	DP1_HCtrl	HStart[3:0]				HStop[3:0]			
0x0137	0x00	DP1_BlockCtrl3	—	—	—	—	—	—	—	BlockPacking Mode
DATA PORT 3 REGISTERS										
0x0300	0x00	DP3_IntStat	—	—	—	—	—	—	IntStat Port Ready	IntStat Test Fail
0x0301	0x00	DP3_IntMask	—	—	—	—	—	—	IntMask Port Ready	IntMask Test Fail
0x0302	0x20	DP3_PortCtrl	—	—	Port Direction	Next InvertBank	PortDataMode[1:0]		PortFlowMode[1:0]	
0x0303	0x00	DP3_BlockCtrl1	—	—	—	WordLength[4:0]				
0x0304	0x00	DP3_PrepareStatus	—	—	—	—	—	—	N-Finished Channel 2	N-Finished Channel 1
0x0305	0x00	DP3_PrepareCtrl	—	—	—	—	—	—	Prepare Channel 2	Prepare Channel 1
DATA PORT 3 - BANK 0 REGISTERS										
0x0320	0x00	DP3_ChannelEn	—	—	—	—	—	—	Enable Channel 2	Enable Channel 1
0x0322	0x00	DP3_SampleCtrl1	SampleIntervalLow[7:0]							
0x0323	0x00	DP3_SampleCtrl2	SampleIntervalHigh[7:0]							
0x0324	0x00	DP3_OffsetCtrl1	Offset1[7:0]							
0x0325	0x00	DP3_OffsetCtrl2	Offset2[7:0]							
0x0326	0x00	DP3_HCtrl	HStart[3:0]				HStop[3:0]			
0x0327	0x00	DP3_BlockCtrl3	—	—	—	—	—	—	—	BlockPacking Mode
DATA PORT 3 - BANK 1 REGISTERS										
0x0330	0x00	DP3_ChannelEn	—	—	—	—	—	—	Enable Channel 2	Enable Channel 1
0x0332	0x00	DP3_SampleCtrl1	SampleIntervalLow[7:0]							
0x0333	0x00	DP3_SampleCtrl2	SampleIntervalHigh[7:0]							
0x0334	0x00	DP3_OffsetCtrl1	Offset1[7:0]							
0x0335	0x00	DP3_OffsetCtrl2	Offset2[7:0]							
0x0336	0x00	DP3_HCtrl	HStart[3:0]				HStop[3:0]			
0x0337	0x00	DP3_BlockCtrl3	—	—	—	—	—	—	—	BlockPacking Mode

Control Bit Field Types and Write Access Restrictions

The device control bit fields fall into one of three basic types: read (R), write (W), or read and write (RW). Read-only bit fields (R) have no access restrictions and can be read back safely anytime the configured control interface is active. Every write-enabled bit field (W and RW) can also be read back safely without restriction, however, for write commands they each fall into one of three access subtypes.

The first write subtype is dynamic (denoted as -D). Dynamic bit fields effectively have no access restrictions and can be safely changed (written) in any device state where the control interface is active. The second bit field access subtype is static (denoted as -S). Static bit fields should only be changed (written) when the device is in the software shutdown state (the device enable bit EN is set to a logic low). The third and final type of bit field access

subtype is restricted (denoted with a -R). Unlike static bit fields, restricted bit fields can be written when the device is not in the software shutdown state. However, before restricted bit fields are changed (written), they require that related functional blocks (as specified in [Table 4](#)) be powered down.

The general bit field type and access subtype is provided for every register bit field in the “TYPE” column of the corresponding detailed register description table. For all bit fields with the restricted access subtype the required dependency setting is also denoted in the restriction (“RES”) column.

[Table 4](#) provides a detailed description of all bit field types, access subtypes, and restriction dependencies used by this device. The write access restrictions column lists the specific condition and block-enable control bit fields that must be disabled before changing bit fields with that restriction type.

Table 4. Bit Types, Subtypes, and Write Access Restrictions

BIT FIELD TYPE	WRITE ACCESS	“TYPE” SYMBOL	WRITE ACCESS RESTRICTIONS		“RES” SYMBOL
			DESCRIPTION	CONDITION	
Read	Read Only	R	None	—	—
Read Status	Dynamic	RS	None	—	—
Write	Dynamic	W-D	None	—	—
Read/Write	Dynamic	RW-D	None	—	—
	Static	RW-S	Device in software shutdown	EN = 0	EN
	Restricted	RW-R	Speaker amplifier output path disabled	SPK_EN = 0	SPK
			Speaker amplifier DSP feedback path disabled	SPK_FB_EN = 0	FB
			Both speaker amplifier output path and DSP path disabled	SPK_EN = 0 and SPK_FB_EN = 0	SFB
			PCM data input and output disabled	PCM_RX_EN = 0 and PCM_TX_EN = 0	PCM
			PCM data output disabled	PCM_TX_EN = 0	TXEN
			IRQ bus disabled	IRQ_EN = 0	IRQ
			BDE disabled	BDE_EN = 0	BDE
			All ICC data links disabled	ALL_ICC_x_LINK_EN = 0	ICC

Device Sequencing

To ensure proper device initialization and to prevent audible glitches, the device supplies and control registers must be configured in the correct sequence. During initial device power-up, both the PVDD and DVDD supplies must be powered above their UVLO levels before attempting to program the device. All registers are safe to program while the device is in a state of software shutdown (EN = 0).

When configuring the device for speaker playback, the best practice is to first configure all blocks prior to enabling the speaker output (SPK_EN, [Speaker Path and Speaker DSP Data Feedback Path Enables](#)). When disabling playback, the reverse is true and the speaker output should be disabled first. Playback can also be configured completely (including the speaker enable) before exiting software shutdown, and can likewise be disabled by entering software shutdown. The typical sequencing for a full power-up case is outlined in [Table 5](#), while the typical sequencing for full device shutdown case is outlined in [Table 6](#).

Table 5. Typical Full Power-Up Sequence

STEP	ACTION	DESCRIPTION
1	Power-Up Both Device Supplies	This internally initializes the device settings, starts the control interface, and places the device into the software shutdown state.
2	Drive Hardware Reset High	DVDD must be powered prior to driving the hardware reset input high ($\overline{\text{RESET}}$)
3	Select the Control Interface	After initialization, the device defaults to the SoundWire compatible interface. A start condition on the I ² C bus enables the I ² C and PCM interfaces instead.
4	Start External Clocks and Initialize Register Settings	Prior to exiting software shutdown, all external clocks must be active and stable. For simplest sequencing, program all registers prior to exiting software shutdown.
5	Exit Software Shutdown	Set the software enable bit (EN = 1). If all registers are programmed, audio playback begins within the turn-on time. Optionally, audio volume can also be ramped up to minimize the click-and-pop (SPK_VOL_RMPUP_BYPASS = 0). Note: Software shutdown is the standard idle state between audio playback cases.
6	Digital Volume/Mute	At any time, the digital volume level can be adjusted and mute can be toggled.

Table 6. Typical Full Shutdown Sequence

STEP	ACTION	DESCRIPTION
1	Disable the Speaker Amplifier and Enter Software Shutdown	The speaker amplifier is disabled by setting SPK_EN = 0. It is also automatically disabled by entering software shutdown (EN = 0). Optionally, audio volume can be ramped down to minimize click-and-pop (SPK_VOL_RMPDN_BYPASS = 0).
2	Wait for the Turn-Off Time to Expire	The device completes the transition into software shutdown after the turn-off time expires. At this point, the external clocks can be disabled and all registers can safely be reprogrammed. The speaker amplifier must not be re-enabled until after the turn-off time expires. Note: Software shutdown is the standard idle state between audio playback cases.
3	Enter Hardware Shutdown (Optional)	For system suspend states (if all supplies are not powered down) the device can be placed into hardware shutdown by pulling the $\overline{\text{RESET}}$ input low. The device should be in software shutdown before transitioning into hardware shutdown.
4	Power-Down Supplies	Disable both supplies to power down the device completely.

Device State Control

The device features a combination of both hardware and software controls that can be used to place the device into a reduced power state and/or to return the device to the initial power-on reset (PoR) state.

Hardware Shutdown

The device features an active-low hardware reset input (RESET) that is used to take the device into and out of hardware shutdown. When the reset input is asserted low, the device enters hardware shutdown. To avoid potentially audible glitches, the device should first be placed into software shutdown (EN = 0, wait for the turn-off time) before entering hardware shutdown. The device exits hardware shutdown when DVDD is above its UVLO threshold and the hardware reset input is asserted high. DVDD must be powered and above the UVLO level prior to driving the RESET input high.

In hardware shutdown, the device is configured to its lowest power state. Both the I²C and SoundWire control interfaces are disabled, and all device registers are returned to their PoR states. When exiting hardware shutdown, the device enters software shutdown.

Software Shutdown

The software enable bit field (EN) is used to take the device into and out of software shutdown. Additionally, if PVDD is powered down while DVDD is still powered, the device goes into software shutdown.

When software enable is set low, the device enters software shutdown. In software shutdown, all blocks are disabled except the active control interface. All device register states are retained and can be programmed in software shutdown. When software enable is set high, the device exits software shutdown and returns to its programmed operating state.

Power Supply UVLO

The device monitors both DVDD and PVDD for low-voltage conditions that would prevent normal operation.

If V_{DVDD} drops below the DVDD-UVLO threshold (V_{DVDD_UVLO}), the device stops operating and all device registers are reset to their default PoR values. When V_{DVDD} recovers, the device automatically enters hardware shutdown.

If V_{PVDD} drops below the PVDD-UVLO threshold (V_{PVDD_UVLO}) and DVDD is still powered, the device is placed into software shutdown and the software enable bit field (EN) is set low. When V_{PVDD} recovers, the device remains in software shutdown until software enable (EN) is set high.

Software Reset

The reset bit field (RST) is used to trigger a software reset event. When software reset (RST) is written with a 1, software reset returns the general control registers (but not the SoundWire slave interface registers) to their default (PoR) states. The software reset bit field is write only, and a read always returns 0x00. Writing a 0 to software reset has no effect.

SoundWire Bus Reset

When the device is in SoundWire control mode, a sequence of 4096 successive bit-slots of encoded logic 1s from the SoundWire Master resets all device registers (including the SoundWire slave configuration registers) to the default PoR values.

SoundWire Register Reset

When the device is in SoundWire mode, the register bit field ForceReset in the SCP_Ctrl register resets the SoundWire slave configuration registers to the default PoR values (as defined in SoundWire Specification v1.1). The ForceReset register is write only, and a read of this register always returns zero. Writing a logic-low to the ForceReset bit field has no effect.

Global Enable

REGISTER ADDRESS = 0x20FF					DESCRIPTION
BIT	PoR	BIT NAME	TYPE	RES	
7	0	RESERVED	—	—	Unused Returns 0 if read.
6	0				
5	0				
4	0				
3	0				
2	0				
1	0				
0	0	EN	RW-D	—	Global Enable Disable or enable all blocks and reset all logic except the I ² C interface and control registers. 0 = Device is powered down 1 = Device is enabled

Software Reset

REGISTER ADDRESS = 0x2000					DESCRIPTION
BIT	PoR	BIT NAME	TYPE	RES	
7	0	RESERVED	—	—	Unused Returns 0 if read.
6	0				
5	0				
4	0				
3	0				
2	0				
1	0				
0	0	RST	W-D	—	Software Reset This bit field is used to trigger a software reset event. Writing a 1 resets the device and return the general control registers to their power-on reset states. However, the SoundWire slave interface registers are not affected by a software reset event. Writing a 0 has no effect, and readback always returns 0. 0 = No action 1 = Triggers a software reset event

I²C Serial Interface

The I²C serial control interface is activated when the device detects a valid I²C start condition at the SDA and SCL pins. To detect a valid start condition, the initial power-up of both supplies must have occurred and the device cannot currently be in hardware shutdown.

I²C Slave Address

The slave address is defined as the seven most significant bits (MSBs) followed by the read/write bit. The seven MSBs are programmable through the ADDR connection, and the required SDA and SCL connections for each address are shown in [Table 7](#). The ADDR pin cannot be left unconnected (the device may not communicate). Setting the read/write bit to 1 configures the device for read mode. Setting the read/write bit to 0 configures the device for write mode. The I²C slave address is the first byte of information sent to the device after the START condition.

I²C Slave Interface Operation

The device features an I²C/SMBus™-compatible, 2-wire slave serial interface consisting of a serial data line (SDA) and a serial clock line (SCL). SDA and SCL facilitate communication between the device and the master at clock rates up to 1MHz (FM+ standard).

[Figure 10](#) shows the 2-wire I²C slave interface timing diagram. The master generates SCL and initiates data transfer on the bus. The master device writes data to the device by transmitting the proper slave address fol-

lowed by two register address bytes (most significant byte first) and then the data word. Each transmit sequence is framed by a START (S) or REPEATED START (Sr) condition and a STOP (P) condition. Each word transmitted to the device is 8 bits long and is followed by an acknowledge clock pulse.

A master reading data from the device transmits the proper slave address followed by a series of nine SCL pulses. The device transmits data on SDA in sync with the master-generated SCL pulses. The master acknowledges receipt of each byte of data. Each read sequence is framed by a START (S) or REPEATED START (Sr) condition, a not acknowledge, and a STOP (P) condition.

SDA operates as both an input and an open-drain output. A pullup resistor, typically greater than 500Ω, is required on SDA. SCL operates only as an input. A pullup resistor, typically greater than 500Ω, is required on SCL if there are multiple masters on the bus, or if the single master has an open-drain SCL output. Series resistors in line with SDA and SCL are optional. Series resistors protect the digital inputs of the device from high voltage spikes on the bus lines and minimize crosstalk and undershoot of the bus signals.

Bit Transfer

One data bit is transferred during each SCL cycle. The data on SDA must remain stable during the high period of the SCL pulse. Changes in SDA while SCL is high are control signals (see the [START and STOP Conditions](#) section).

Table 7. Configuring the I²C Slave Address

ADDR CONNECTION	I ² C SLAVE ADDRESS
Connected to DVDD	0x62
Connected to DGND	0x64
Connected to SDA	0x66
Connected to SCL	0x68

START and STOP Conditions

SDA and SCL idle high when the bus is not in use. A master initiates communication by issuing a START condition. A START condition is a high-to-low transition on SDA with SCL high. A STOP condition is a low-to-high transition on SDA while SCL is high. A START condition from the master signals the beginning of a transmission to the device. The master terminates transmission and frees the bus by issuing a STOP condition. The bus remains active if a REPEATED START condition is generated instead of a STOP condition.

Early STOP Conditions

The device recognizes a STOP condition at any point during a data transmission, except if the STOP condition occurs in the same high pulse as a START condition. For proper operation, do not send a STOP condition during the same SCL high pulse as the START condition.

Acknowledge

The acknowledge bit (ACK) is a clocked 9th bit that the device uses to handshake receipt each byte of data when in write mode (Figure 11). The device pulls down SDA during the entire master-generated 9th clock pulse if the previous byte is successfully received. Monitoring ACK allows for detection of unsuccessful data transfers. An unsuccessful data transfer occurs if a receiving device is busy or if a system fault has occurred. In the event of an unsuccessful data transfer, the bus master retries communication. The master pulls down SDA during the 9th clock cycle to acknowledge receipt of data when the device is in read mode. An acknowledge is sent by the master after each read byte to allow data transfer to continue. A not-acknowledge is sent when the master reads the final byte of data from the device, followed by a STOP condition.

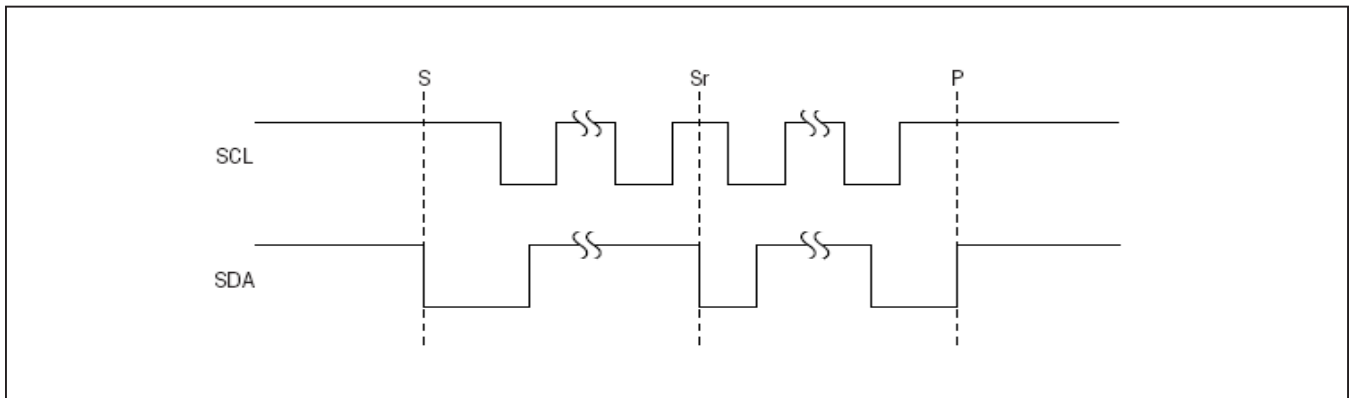

Figure 10. START, STOP, and REPEATED START Conditions

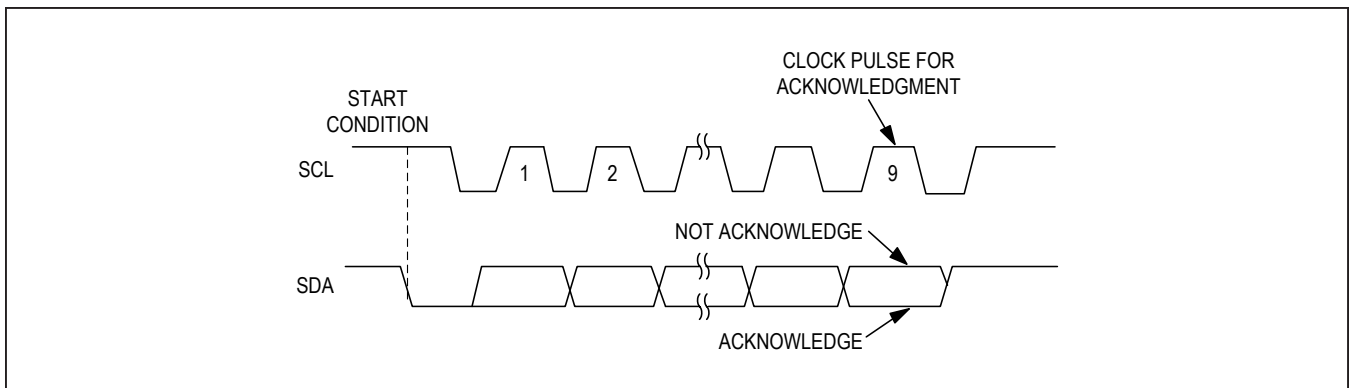

Figure 11. Acknowledge

I²C Write Data Format

A write to the device includes transmission of a START condition, the slave address with the R/W bit set to 0, two bytes of data to configure the internal register address pointer, one or more bytes of data, and a STOP condition. Figure 12 illustrates the proper frame format for writing one byte of data to the device. Figure 13 illustrates the frame format for writing n-bytes of data to the device.

The slave address with the R/W bit set to 0 indicates that the master intends to write data to the device. The device acknowledges receipt of the address byte during the master-generated 9th SCL pulse.

The second and third bytes transmitted from the master configure the device's internal register address pointer. The pointer tells the device where to write the next byte of data. An acknowledge pulse is sent by the device upon receipt of the address pointer data.

The third byte sent to the device contains the data that is written to the chosen register. An acknowledge pulse from the device signals receipt of the data byte. The address pointer auto-increments to the next register address after each received data byte. This auto-increment feature allows a master to write to sequential registers within one continuous frame. The master signals the end of transmission by issuing a STOP condition.

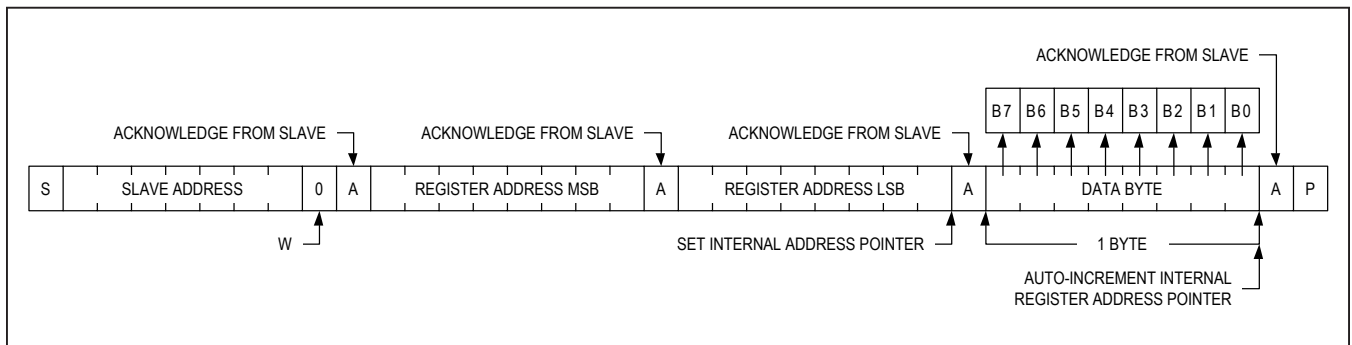

Figure 12. Writing One Byte of Data to the Slave

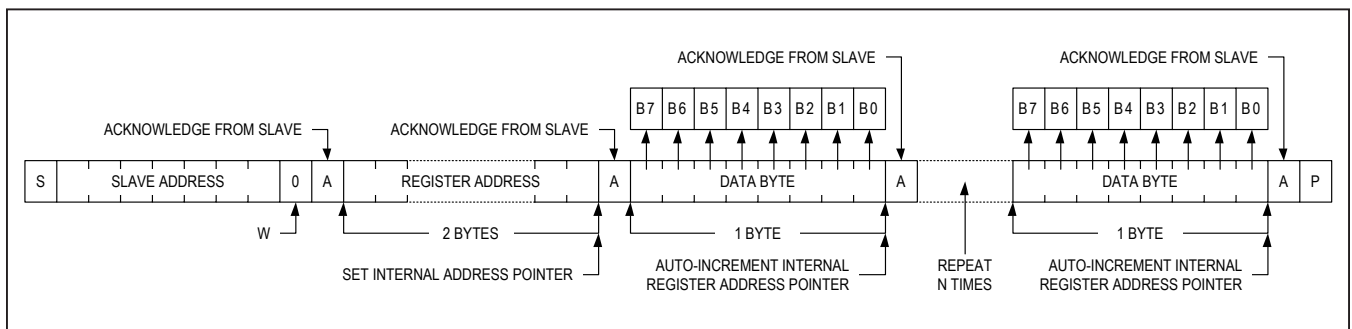

Figure 13. Writing n-Bytes of Data to the Slave

I²C Read Data Format

The device address pointer must be preset to a specific register address before a read command is issued. The master presets the slave address pointer by first sending the slave device address with the R/W bit set to 0, followed by the desired slave register address. Then, to initiate a read operation, a REPEATED START condition is sent followed by the slave device address with the R/W bit set to 1. The slave acknowledges receipt of its slave address by pulling SDA low during the 9th SCL clock pulse. The slave would then transmit the contents of the register at the preset address. Transmitted slave data is valid on the rising edge of SCL.

In I²C slave mode, the device address pointer auto-increments after each read data byte. This auto-increment feature allows all device registers to be read sequentially within one continuous frame. A STOP condition can be issued after any number of read data bytes.

The master acknowledges receipt of each read byte during the acknowledge clock pulse. The master must acknowledge all correctly received bytes except the last byte. The final byte must be followed by a not acknowledge from the master and then a STOP condition. Figure 14 illustrates the frame format for reading one byte from the device. Figure 15 illustrates the frame format for reading multiple bytes from the device.

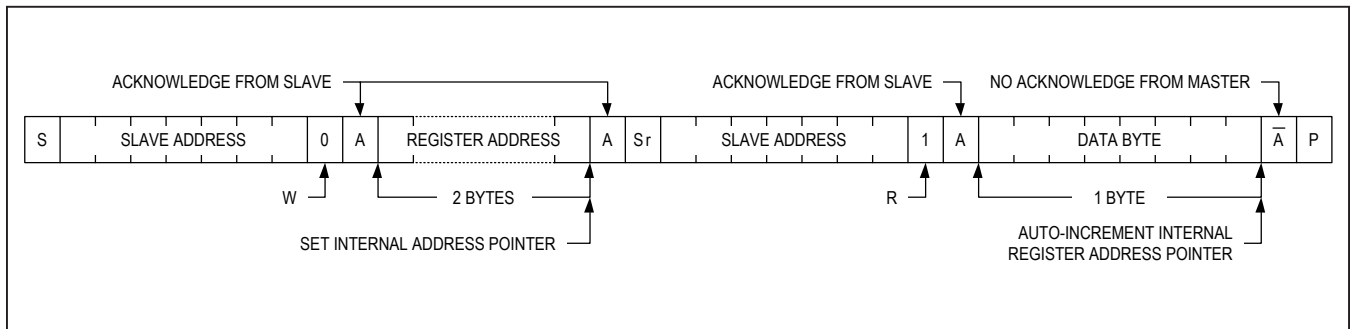

Figure 14. Reading One Byte of Data from the Slave

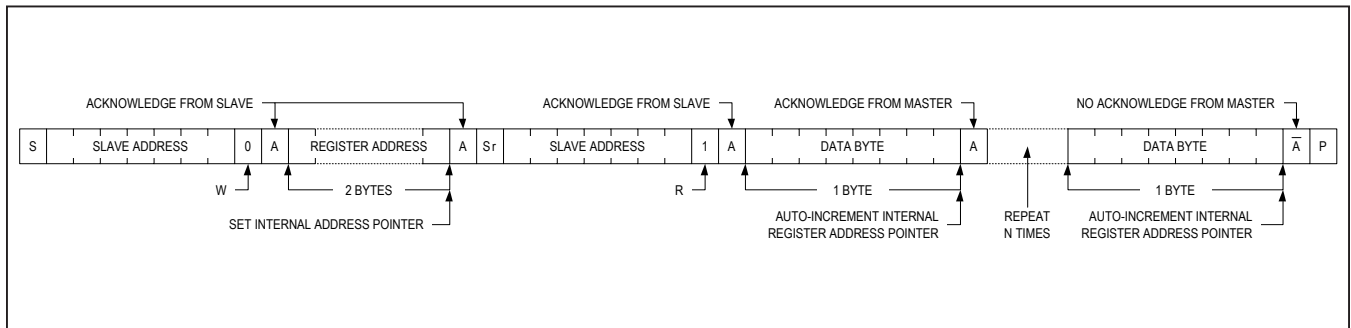

Figure 15. Reading n-Bytes of Data from the Slave

PCM Interface

The flexible PCM interface supports common sample rates from 16kHz to 96kHz, channel word lengths of 16-, 24-, and 32-bits, the standard I²S, left-justified, and TDM data formats.

PCM Clock Configuration

The digital audio interface defaults into PCM slave interface mode (INTERFACE_MODE bit field, [Audio Interface Mode Configuration](#)). The PCM slave interface requires the host to supply both BCLK and LRCLK. To configure the PCM interface clock inputs, the host must program both the device sample rate and BCLK to LRCLK ratio.

Clock Ratio Configuration

The PCM interface sample rate must be configured to match the frequency of the frame clock (LRCLK) using the PCM_SR registers. The speaker path sample rate (SPK_SR) and the PCM interface sample rate (PCM_SR) must be configured by the host to be the same.

The device supports a range of BCLK to LRCLK clock ratios (PCM_BSEL) ranging from 32 to 512. However, based on the selected PCM interface sample rate (LRCLK frequency), the configured clock ratio cannot result in a BCLK frequency that exceeds 15.36MHz.

Audio Interface Mode Configuration

REGISTER ADDRESS = 0x2025					DESCRIPTION
BIT	PoR	BIT NAME	TYPE	RES	
7	0	RESERVED	—	—	Unused Returns 0 if read.
6	0				
5	0				
4	0				
3	0				
2	0				
1	0	INTERFACE_MODE[1:0]	RW-S	EN	Audio Interface Mode Selects the digital audio data interface mode. 00 = PCM slave interface mode (BCLK input, LRCLK input) 01 = Reserved 10 = Reserved 11 = SoundWire slave interface mode (SWCLK input)
0	0				

PCM Interface Sample Rate

REGISTER ADDRESS = 0x2027					DESCRIPTION
BIT	PoR	BIT NAME	TYPE	RES	
7	0	RESERVED	—	—	Unused Returns 0 if read.
6	0				
5	0				
4	0				
3	1	PCM_SR[3:0]	RW-S	EN	PCM Sample Rate Sets the sample rate of the PCM interface. This corresponds to the input or desired LRCLK frequency. 0000-0010 = Reserved 0011 = 16kHz 0100 = 22.05kHz 0101 = 24kHz 0110 = 32kHz 0111 = 44.1kHz 1000 = 48kHz 1001 = 88.2kHz 1010 = 96kHz 1011 to 1111 = Reserved
2	0				
1	0				
0	0				

Speaker Path Sample Rate

REGISTER ADDRESS = 0x2028					DESCRIPTION
BIT	PoR	BIT NAME	TYPE	RES	
7	1	SPK_SR[3:0]	RW-S	EN	Speaker Amplifier Path Sample Rate Sets the sample rate of the speaker amplifier path. 0000-0010 = Reserved 0011 = 16kHz 0100 = 22.05kHz 0101 = 24kHz 0110 = 32kHz 0111 = 44.1kHz 1000 = 48kHz 1001 = 88.2kHz 1010 = 96kHz 1011 to 1111 = Reserved
6	0				
5	0				
4	0				
3	1				
2	0	RESERVED	—	—	Unused
1	0				
0	0				

PCM Interface Clock Ratio Configuration

REGISTER ADDRESS = 0x2026					DESCRIPTION
BIT	PoR	BIT NAME	TYPE	RES	
7	0	RESERVED	—	—	Unused Returns 0 if read.
6	0				
5	0				
4	0	PCM_BCLKEDGE	RW-S	EN	Active BCLK Edge Control Selects the active BCLK edge. 0 = Data captured and valid on rising edge of BCLK. 1 = Data captured and valid on falling edge of BCLK.
3	0	PCM_BSEL[3:0]	RW-S	EN	BCLK to LRCLK Ratio Selects the number of BCLKs per LRCLK for PCM. 0000 to 0001 = Reserved 0010 = 32 0011 = 48 0100 = 64 0101 = 96 0110 = 128 0111 = 192 1000 = 256 1001 = 384 1010 = 512 1011 = 320 1100 to 1111 = Reserved
2	1				
1	0				
0	0				

PCM Data Format Configuration

The device supports the standard I²S, left-justified, TDM data formats, and the operating mode is configured using the PCM_FORMAT bit field.

I²S and Left-Justified Mode

I²S and left-justified formats support two channels that can be 16, 24, or 32 bits in length. The BCLK to LRCLK ratio (PCM_BSEL) must be configured to be twice the desired channel length. The audio data word size is configurable to 16, 24, or 32 bits in length (PCM_DATA_WIDTH), but must be programmed to be less than or equal to the channel length. If the resulting channel length exceeds

the configured data word size, then the data input LSBs are truncated and the data output LSBs are padded with either zero or Hi-Z data based on the PCM_TX_CHm_HIZ register bit setting.

With the default PCM settings, falling LRCLK indicates the start of a new frame and the left channel data (channel 0) while rising LRCLK indicates the right channel data (channel 1). In I²S mode, the MSB of the audio word is latched on the second active BCLK edge after an LRCLK transition. In left-justified mode, the MSB of the audio word is latched on the first active BCLK edge after an LRCLK transition.

Table 8. Supported I²S/Left-Justified Mode Configurations

CHANNELS	CHANNEL LENGTH	BCLK TO LRCLK RATIO (PCM_BSEL)	SUPPORTED DATA WORD SIZES (PCM_DATA_WIDTH)
2	16	32	16
	24	48	16, 24
	32	64	16, 24, 32

The PCM_BCLKEDGE register bit selects the BCLK active edge that is used for data capture and data output. The PCM_CHANSEL bit configures which LRCLK edge indicates the start of a new frame (channel 0), and LRCLK

transitions always align with the inactive BCLK edge. The data output is valid on the same active BCLK edge as the data input. The data output also transitions on the same edge as the data input.

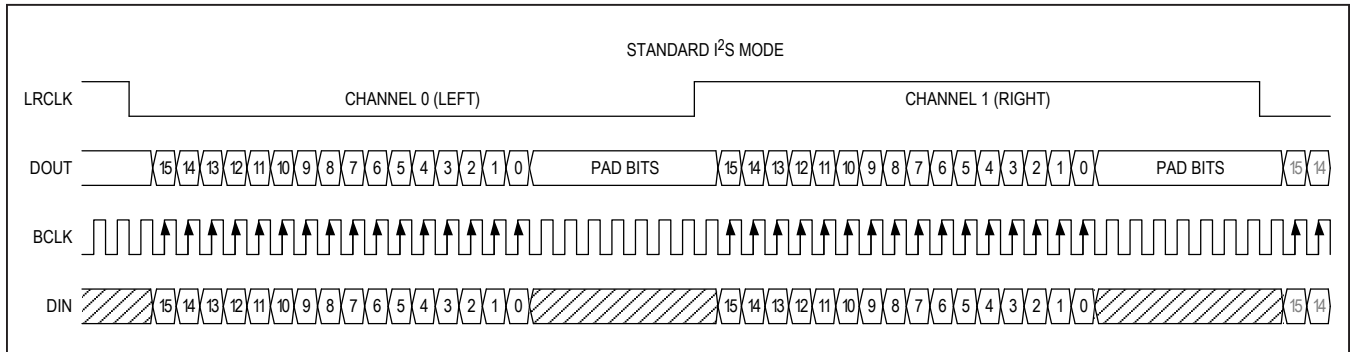

Figure 16. Standard I²S Mode Data Format Example (16-Bit Data Word, 24-Bit Channel Length)

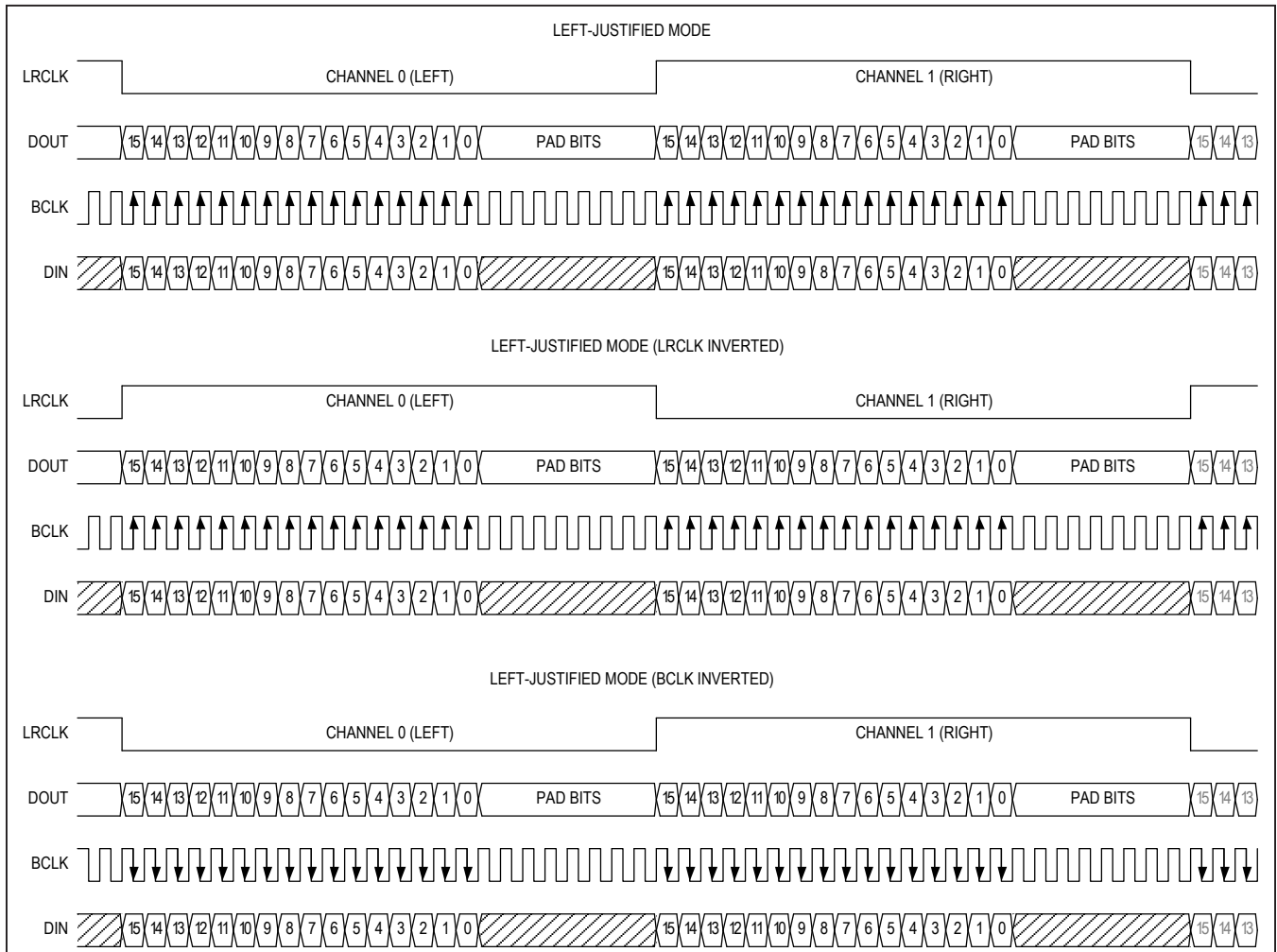

Figure 17. Left-Justified Mode Data Format Examples (16-Bit Data Word, 24-Bit Channel Length)

TDM Modes

The provided TDM modes support up to 16 audio channels of 16-, 24-, or 32-bit data each. The number of TDM channels is determined by both the selected BCLK to LRCLK ratio (PCM_BSEL) and the selected data word size (PCM_DATA_WIDTH). In TDM mode, the channel length and data word size are always equal.

With the default PCM interface settings, in TDM mode a rising frame clock (LRCLK) edge acts as the frame sync pulse and indicates the start of a new frame. The frame sync pulse width must be equal to at least one bit clock period; however, the falling edge can occur at any time if it does not violate the setup time of the next frame sync

pulse rising edge. The PCM_CHANSEL bit can be used to invert the LRCLK edges (sync pulse) used to start a TDM frame.

In TDM mode, the MSB of the first audio word can be latched on the first, second, or third active BCLK edge after the sync pulse and is programmed by the PCM_FORMAT bits (TDM mode 0, 1, and 2). Additionally, the PCM_BCLKEDGE register bit allows for programmability of the BCLK edge that is used for data capture and data output. The data output is valid on the same active BCLK edge as the data input. The data output also transitions on the same edge as data input.

Table 9. Supported TDM Mode Configurations

CHANNELS	DATA WORD SIZES (PCM_DATA_WIDTH)	BCLK TO LRCLK RATIO (PCM_BSEL)	MAXIMUM SUPPORTED SAMPLE RATE (f _{LRCLK}) (kHz)	
2	16	32	96	
	24	48		
	32	64		
4	16	64		
	24	96		
	32	128		
8	16	128	48	
	24	192		
	32	256		
10	32	320		
16	16	256		32
	24	384		
	32	512	24	

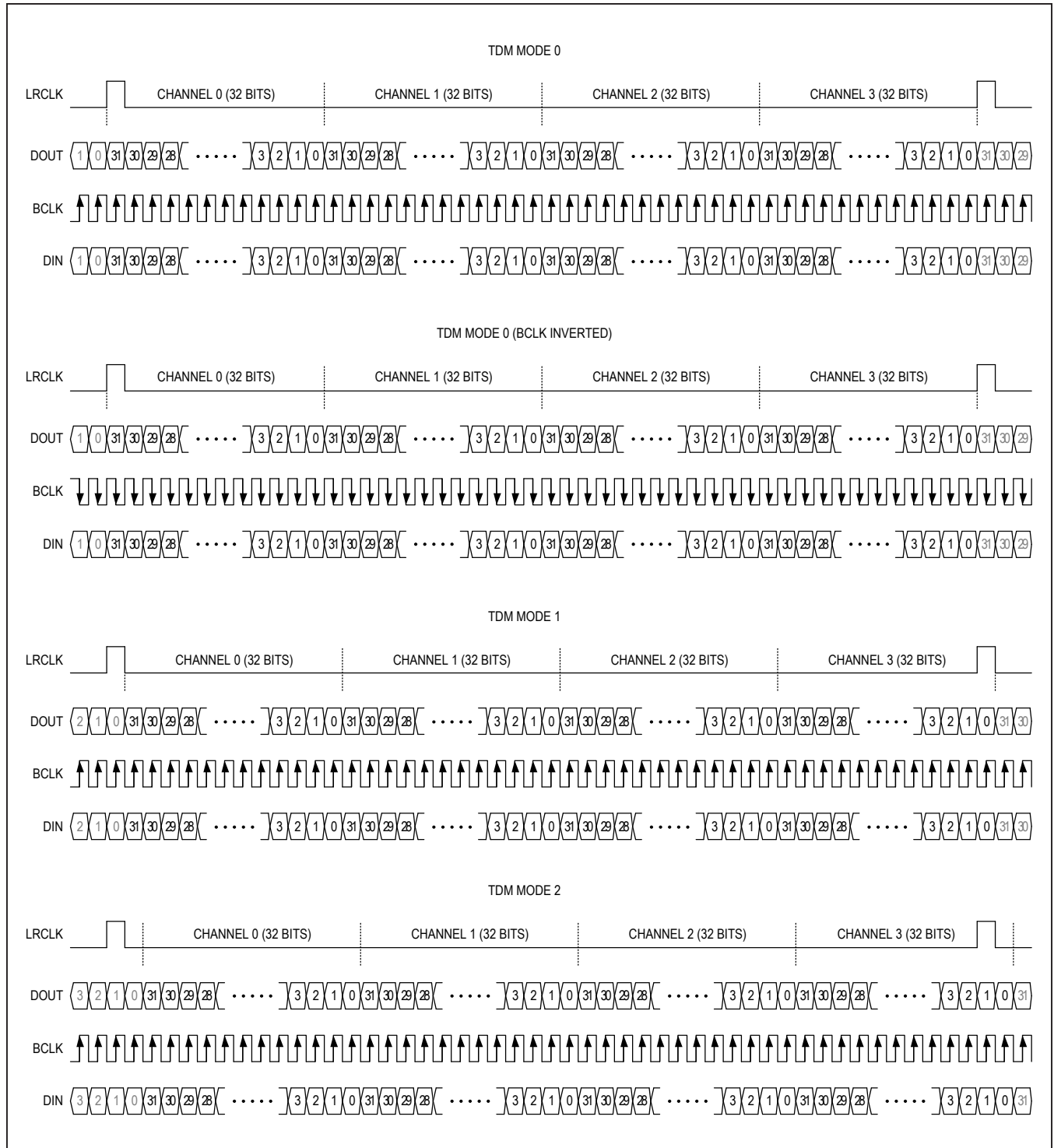

Figure 18. TDM Mode Data Format Examples (4 Channels, 32-Bit Data Word and Channel Length)

PCM Interface Data Format Configuration

REGISTER ADDRESS = 0x2024					DESCRIPTION
BIT	PoR	BIT NAME	TYPE	RES	
7	1	PCM_DATA_WIDTH[1:0]	RW-R	PCM	Data Word Size Control Configures the PCM data word size for each channel. 00 = Reserved 01 = 16-Bit 10 = 24-Bit 11 = 32-Bit
6	1				
5	0	PCM_FORMAT[2:0]	RW-R	PCM	PCM Format Select Selects the PCM data format. 000 = I ² S mode 001 = Left-justified 010 = Reserved 011 = TDM mode 0 (0 BCLK delay from LRCLK) 100 = TDM mode 1 (1 BCLK delay from LRCLK) 101 = TDM mode 2 (2 BCLK delay from LRCLK) 110 to 111 = Reserved
4	0				
3	0				
2	0	RESERVED	—	—	Unused - Returns 0 if read
1	0	PCM_CHANSEL	RW-R	PCM	Active LRCLK Edge Control Selects which LRCLK edge starts a new frame (channel 0). 0 = In I ² S and LJ modes: falling LRCLK edge starts a new frame. In TDM modes: rising LRCLK edge starts a new frame. 1 = In I ² S and LJ modes: rising LRCLK edge starts a new frame. In TDM modes: falling LRCLK edge starts a new frame.
0	0	PCM_TX_EXTRA_HIZ	RW-R	PCM	Extra BCLK Cycles Hi-Z Control Select whether DOUT is driven to zero or Hi-Z during extra BCLK cycles. 0 = Drive DOUT to zero for extra BCLK cycles. 1 = Drive DOUT to Hi-Z for extra BCLK cycles.

PCM Data Path Configuration

The PCM interface data input accepts the source data for the speaker path, while the data output accepts data from the speaker DSP monitor path.

PCM Data Input

The PCM interface data input (DIN) is enabled with the PCM_RX_EN bit and can accept data from up to 2 valid input channels. In I²S and left-justified modes, only 2 channels are available. In TDM mode, up to 16 channels of data may be available.

The device provides an input digital mono mixer that can route a single channel or can mix two PCM input channels to create a mono input to the amplifier path. The DMMIX_CFG bit is used to configure the mixer, while the DMMIX_CH0_SOURCE and DMMIX_CH1_SOURCE bits select which of the 16 PCM input channels are used as the input to the mono mixer. If the PCM data input is disabled, no data is accepted by the mono mixer input and the mono mixer output drives a zero code value into the amplifier path.

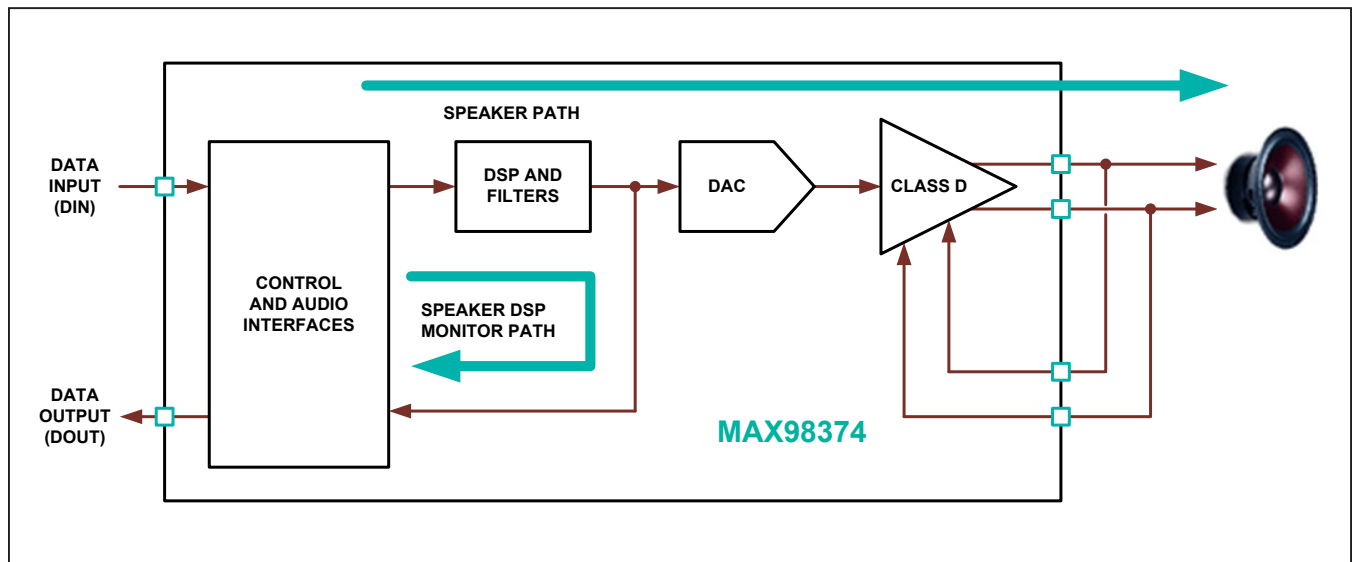

Figure 19. Device Signal Path Diagram

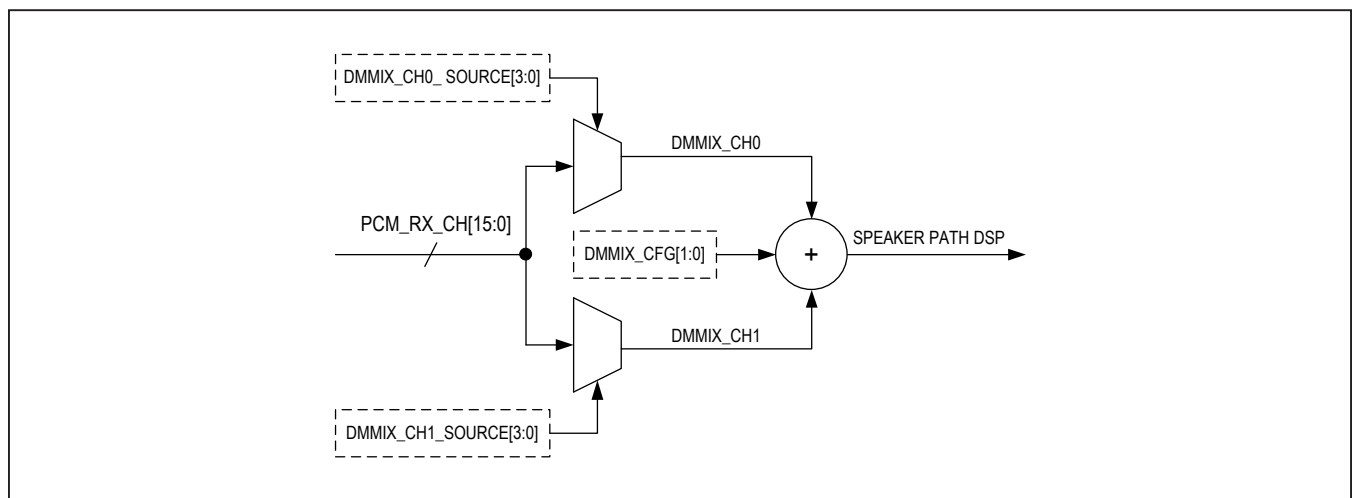

Figure 20 Digital Monomix Control

PCM Interface Data Input (DIN) Enable

REGISTER ADDRESS = 0x202B					DESCRIPTION
BIT	PoR	BIT NAME	TYPE	RES	
7	0	RESERVED	—	—	Unused Returns 0 if read.
6	0				
5	0				
4	0				
3	0				
2	0				
1	0				
0	0	PCM_RX_EN	RW-R	SFB	PCM Receiver Enable Enables the data input (DIN) of the PCM interface. 0 = PCM data input disabled 1 = PCM data input enabled

PCM Interface Digital Mono Mixer Configuration 1

REGISTER ADDRESS = 0x2029					DESCRIPTION
BIT	PoR	BIT NAME	TYPE	RES	
7	0	DMMIX_CFG[1:0]	RW-R	SFB	Mono Mixer Configuration Determines the behavior of the mono mixer circuit. 00 = Output of mono mixer is channel 0 01 = Output of mono mixer is channel 1 10 = Output of mono mixer is (channel 0 + channel 1)/2 11 = Reserved
6	0				
5	0	RESERVED	—	—	Unused Returns 0 if read.
4	0				
3	0	DMMIX_CH0_SOURCE[3:0]	RW-R	SFB	Mono Mixer Channel 0 Source Select Selects which PCM interface data input channel is assigned to channel 0 of the digital mono mixer. 0000 = Channel 0 gets PCM interface data input channel 0. 0001 = Channel 0 gets PCM interface data input channel 1. 1110 = Channel 0 gets PCM interface data input channel 14. 1111 = Channel 0 gets PCM interface data input channel 15.
2	0				
1	0				
0	0				

PCM Interface Digital Mono Mixer Configuration 2

REGISTER ADDRESS = 0x202A					DESCRIPTION
BIT	PoR	BIT NAME	TYPE	RES	
7	0	RESERVED	—	—	Unused Returns 0 if read.
6	0				
5	0				
4	0				
3	0	DMMIX_CH1_SOURCE[3:0]	RW-R	SFB	Mono Mixer Channel 1 Source Select Selects which PCM interface data input channel is assigned to channel 1 of the digital mono mixer. 0000 = Channel 1 gets PCM interface data input channel 0. 0001 = Channel 1 gets PCM interface data input channel 1. 1110 = Channel 1 gets PCM interface data input channel 14. 1111 = Channel 1 gets PCM interface data input channel 15.
2	0				
1	0				
0	0				

PCM Data Output

The PCM interface data output (DOUT) is enabled by the PCM_TX_EN bit and can drive output data onto any valid enabled output channel. In I²S and left-justified modes, only 2 output channels are available. In TDM mode, up to 16 output channels may be available.

It is possible to output the result of the speaker amplifier path DSP (taken at the input to the DAC) to the PCM Interface output by enabling the SPK_FB_EN and PCM_SPK_FB_DEST register bits. The host can use this to

monitor the data that is being driven into the DAC (after the digital volume, BDE, etc.). It is invalid for SPK_FB_EN to be 1 while SPK_EN is 0.

If an output channel is enabled and no data source is assigned to it, then the output data is all zeros. The PCM data output is Hi-Z if the device is disabled (EN = 0), the PCM data output is disabled (PCM_TX_EN = 0), or all output channels are set to a Hi-Z output (All PCM_TX_CHn_HIZ = 1). A summary of the controls for the PCM data output (DOUT) are shown in [Table 10](#).

Table 10. Control Registers and the DOUT Pin

EN	PCM_TX_CH_EN	PCM_TX_CHn_HIZ	CHANNEL n SELECTED AS THE DESTINATION FOR PATH*	DOUT FOR CHANNEL n
0	—	—	—	Hi-Z (all channels)
1	0	—	—	Hi-Z (all channels)
1	1	1	—	Hi-Z (channel n)
1	1	0	No	0 (channel n)
1	1	0	Yes	Data (channel n)

* A channel is selected if a path is both enabled and its destination bit field corresponds to that channel.

PCM Interface Data Output (DOUT) Enable

REGISTER ADDRESS = 0x202C					DESCRIPTION
BIT	PoR	BIT NAME	TYPE	RES	
7	0	RESERVED	—	—	Unused Returns 0 if read.
6	0				
5	0				
4	0				
3	0				
2	0				
1	0				
0	0	PCM_TX_EN	RW-D	—	PCM Transmitter Enable Enables the data output (DOUT) of the PCM interface. 0 = PCM data output disabled 1 = PCM data output enabled

PCM Interface Data Output Speaker DSP Feedback Channel Source

REGISTER ADDRESS = 0x2023					DESCRIPTION
BIT	PoR	BIT NAME	TYPE	RES	
7	0	RESERVED	—	—	Unused Returns 0 if read.
6	0				
5	0				
4	0				
3	0	PCM_SPK_ FB_DEST[3:0]	RW-R	FB	Speaker Amplifier DSP to PCM Feedback Destination PCM data output channel selection for the speaker amplifier DSP to PCM feedback path. 0000 = PCM channel 0 0001 = PCM channel 1 ... = ... 1110 = PCM channel 14 1111 = PCM channel 15
2	0				
1	0				
0	0				

PCM Interface Data Output Channel Configuration 1

REGISTER ADDRESS = 0x2020					DESCRIPTION
BIT	PoR	BIT NAME	TYPE	RES	
7	1	PCM_TX_CH7_HIZ	RW-R	TXEN	PCM Transmit Channel 7 Hi-Z Configuration 0 = Transmit channel 7 output is data/zeros 1 = Transmit channel 7 output is Hi-Z
6	1	PCM_TX_CH6_HIZ	RW-R	TXEN	PCM Transmit Channel 6 Hi-Z Configuration 0 = Transmit channel 6 output is data/zeros 1 = Transmit channel 6 output is Hi-Z
5	1	PCM_TX_CH5_HIZ	RW-R	TXEN	PCM Transmit Channel 5 Hi-Z Configuration 0 = Transmit channel 5 output is data/zeros 1 = Transmit channel 5 output is Hi-Z
4	1	PCM_TX_CH4_HIZ	RW-R	TXEN	PCM Transmit Channel 4 Hi-Z Configuration 0 = Transmit channel 4 output is data/zeros 1 = Transmit channel 4 output is Hi-Z
3	1	PCM_TX_CH3_HIZ	RW-R	TXEN	PCM Transmit Channel 3 Hi-Z Configuration 0 = Transmit channel 3 output is data/zeros 1 = Transmit channel 3 output is Hi-Z
2	1	PCM_TX_CH2_HIZ	RW-R	TXEN	PCM Transmit Channel 2 Hi-Z Configuration 0 = Transmit channel 2 output is data/zeros 1 = Transmit channel 2 output is Hi-Z
1	1	PCM_TX_CH1_HIZ	RW-R	TXEN	PCM Transmit Channel 1 Hi-Z Configuration 0 = Transmit channel 1 output is data/zeros 1 = Transmit channel 1 output is Hi-Z
0	0	PCM_TX_CH0_HIZ	RW-R	TXEN	PCM Transmit Channel 0 Hi-Z Configuration 0 = Transmit channel 0 output is data/zeros 1 = Transmit channel 0 output is Hi-Z

PCM Interface Data Output Channel Configuration 2

REGISTER ADDRESS = 0x2021					DESCRIPTION
BIT	PoR	BIT NAME	TYPE	RES	
7	1	PCM_TX_CH15_HIZ	RW-R	TXEN	PCM Transmit Channel 15 Hi-Z Configuration 0 = Transmit channel 15 output is data/zeros 1 = Transmit channel 15 output is Hi-Z
6	1	PCM_TX_CH14_HIZ	RW-R	TXEN	PCM Transmit Channel 14 Hi-Z Configuration 0 = Transmit channel 14 output is data/zeros 1 = Transmit channel 14 output is Hi-Z
5	1	PCM_TX_CH13_HIZ	RW-R	TXEN	PCM Transmit Channel 13 Hi-Z Configuration 0 = Transmit channel 13 output is data/zeros 1 = Transmit channel 13 output is Hi-Z
4	1	PCM_TX_CH12_HIZ	RW-R	TXEN	PCM Transmit Channel 12 Hi-Z Configuration 0 = Transmit channel 12 output is data/zeros 1 = Transmit channel 12 output is Hi-Z
3	1	PCM_TX_CH11_HIZ	RW-R	TXEN	PCM Transmit Channel 11 Hi-Z Configuration 0 = Transmit channel 11 output is data/zeros 1 = Transmit channel 11 output is Hi-Z
2	1	PCM_TX_CH10_HIZ	RW-R	TXEN	PCM Transmit Channel 10 Hi-Z Configuration 0 = Transmit channel 10 output is data/zeros 1 = Transmit channel 10 output is Hi-Z
1	1	PCM_TX_CH9_HIZ	RW-R	TXEN	PCM Transmit Channel 9 Hi-Z Configuration 0 = Transmit channel 9 output is data/zeros 1 = Transmit channel 9 output is Hi-Z
0	1	PCM_TX_CH8_HIZ	RW-R	TXEN	PCM Transmit Channel 8 Hi-Z Configuration 0 = Transmit channel 8 output is data/zeros 1 = Transmit channel 8 output is Hi-Z

SoundWire Slave Interface

When in SoundWire mode, the SoundWire compatible slave interface supports both audio and control data transport over the shared 2-wire bus comprising a clock input (SWCLK) and a bidirectional data input/output (SWDATA). For device configuration, the SoundWire master can access both the general control and SoundWire slave interface registers. The SoundWire slave interface receives and routes all enabled device status interrupts to the SoundWire master for servicing.

Set the INTERFACE_MODE bit field ([Audio Interface Mode Configuration](#)) to 0x3 to select SoundWire slave interface mode for digital audio data. For speaker path playback, the SoundWire compatible slave interface provides an input data port that accepts stereo PCM audio data.

SoundWire Slave Device Identification and Addressing

The SoundWire compatible slave interface provides a 48-bit value (Device_Id[47:0] in the SCP_Devid_0 to SCP_Devid_5 registers) that is read by the SoundWire Master to identify the connected SoundWire slave device. The SoundWire slave device identification bit field contains multiple segments each detailed in [Table 11](#). All segments are fixed except for the slave device unique ID.

The 4-bit SoundWire slave device unique ID (Device_Id[43:40]) is pin configurable and has eight possible combinations. To select the device unique ID, connect the ADDR, SDA, and SCL pins as shown in [Table 12](#).

Table 11. SoundWire Slave Device Identification

REGISTER	BIT FIELD SEGMENT	DESCRIPTION	VALUE
SCP_Devid_0	Device_Id[47:44]	SoundWire Version Number	0x2
	Device_Id[43:40]	Slave Device Unique ID Decoded From Pin	0x0 to 0x8
SCP_Devid_1 and SCP_Devid_2	Device_Id[39:24]	MIPI Assigned Manufacturer ID	0x019F
SCP_Devid_3 and SCP_Devid_4	Device_Id[23:8]	Audio Part Number (OTP Programmable)	0x8374
SCP_Devid_5	Device_Id[7:0]	Class—MIPI Reserved	0x00

Table 12. SoundWire Slave Device Unique ID Configuration

ADDR PIN	SDA PIN	SCL PIN	DEVICE UNIQUE ID
Connect to DGND	Connect to DGND	Connect to DGND	0x1
Connect to DGND	Connect to DVDD	Connect to DGND	0x2
Connect to DGND	Connect to DGND	Connect to DVDD	0x3
Connect to DGND	Connect to DVDD	Connect to DVDD	0x4
Connect to DVDD	Connect to DVDD	Connect to DVDD	0x5
Connect to DVDD	Connect to DVDD	Connect to DGND	0x6
Connect to DVDD	Connect to DGND	Connect to DVDD	0x7
Connect to DVDD	Connect to DGND	Connect to DGND	0x8

SoundWire Clock Configuration

The SoundWire compatible slave interface operates and supports device programming with any valid input SoundWire clock frequency (as specified in version 1.1 of the SoundWire specification). However, in this mode, the external SoundWire clock is also the source clock for all internal clock generation (Figure 21).

Therefore, for the device audio and data paths to operate, the external SoundWire clock frequency must either

match or be an integer divider (2/4/8) of one of the supported input clock frequencies. The expected SoundWire input clock frequency is programmed using the input clock configuration register ([SoundWire Input Clock Configuration](#)). The SoundWire clock frequency selection and rate divider are calculated with the following formula:

$$f_{SWCLK} = \frac{SWIRE_CLK_SEL[2:0]}{SWIRE_CLK_RATE[1:0]}$$

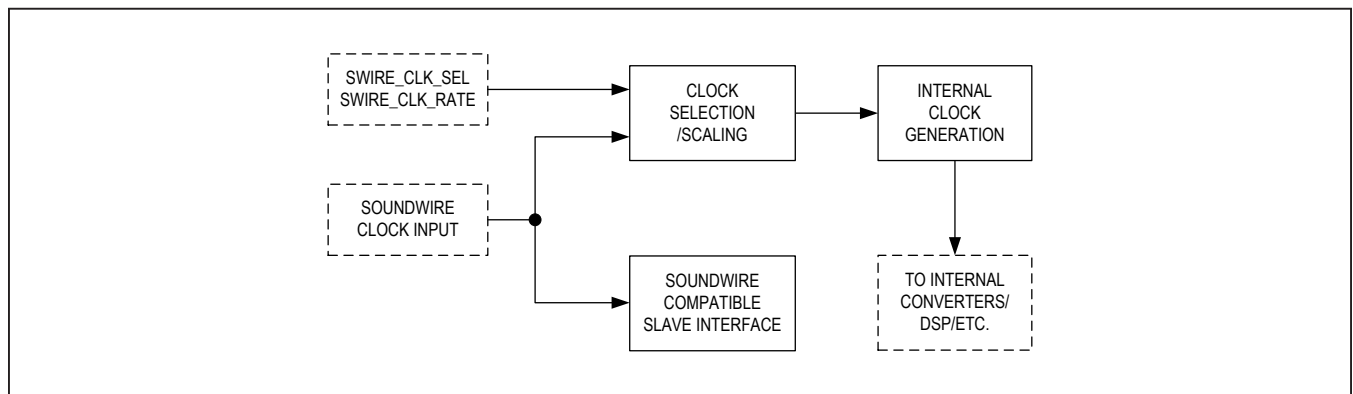

Figure 21. Internal Clock Generation in SoundWire Control Mode

SoundWire Input Clock Configuration

REGISTER ADDRESS = 0x2036					DESCRIPTION
BIT	PoR	BIT NAME	TYPE	RES	
7	0	RESERVED	—	—	Unused Returns 0 if read.
6	0				
5	0				
4	0	SWIRE_CLK_RATE[1:0]	RW-S	EN	SoundWire Input Clock Rate Divider Selects the SoundWire input clock rate divider. The SoundWire clock frequency must match the clock family selected divided by this setting. 00: Divide by 1 (default) 10: Divide by 4 01: Divide by 2 11: Divide by 8
3	0				
2	1	SWIRE_CLK_SEL[2:0]	RW-S	EN	SoundWire Input Clock Frequency Family Selects the SoundWire input clock frequency family. The input clock frequency must match or be a supported integer divided by this setting. Note: The 13MHz clock family requires a divider of either 2 or 4. 000: 7.68Mhz 100: 12.00Mhz 001: 8.40Mhz 101: 12.288Mhz 010: 9.60Mhz 110: 13.00Mhz 011: 11.2896Mhz 111: Reserved
1	0				
0	1				

SoundWire Slave Control Port (SCP) Configuration

The device SCP supports the options shown in [Table 13](#). The SCP configuration bit fields are in the SoundWire slave interface registers from address 0x0040 to address 0x0070. For detailed register and bit field descriptions, reference the full MIPI SoundWire® Specification (Version 1.1).

SoundWire Device Data Port (DP) Configuration

The SoundWire slave interface provides four data ports, each of which is described in [Table 14](#).

The speaker path and amplifier DSP path data ports support all data flow modes (Isochronous, Tx-Controlled, Rx-Controlled, Full-Asynchronous). Data port test modes (Normal, PRBS, Static-0, and Static-1) are provided.

When operating as a passive slave (device is attached to the SoundWire bus but all data ports are deactivated) the interface is optimized to minimize power consumption, and only the logic cells that need to be active are switching. Data port power is managed using the SoundWire defined Prepare-Ready-Activate mechanism. The SoundWire master should only enable and disable slave interface data ports while the device is in software shutdown.

The provided data ports support a subset of options as shown in [Table 15](#). The data port control bit fields are located in the SoundWire slave interface registers from address 0x0100 to address 0x0337. For detailed register and bit field descriptions, reference the full MIPI SoundWire® Specification (Version 1.1).

Table 13. SoundWire Slave Control Port (SCP) Options

SLAVE CONTROL PORT OPTION	PROVIDED
Implementation Defined Interrupt 1	Yes
Clock-Stop Mode 1	Yes
Clock-Stop Prepare State Machine	Simplified
Clock-Stop Asynchronous Wake Up	No
Address Paging	No
Multi-Lane	No
Bridging	No
High Phy	No
Test Mode	No
Broadcast Read Response	Command Ignored

Table 14. SoundWire Slave Interface Data Port Assignments

NUMBER	DIRECTION	TYPE	CHANNELS	WORD SIZE	FUNCTION
Data Port 0	—	—	—	—	Not Supported
Data Port 1	Rx (Input)	Full	2	32-Bit	Data Input for the Speaker Path
Data Port 2	—	—	—	—	Not Supported
Data Port 3	Tx (Output)	Full	2	16-Bit	Data Output for amplifier DSP path
Data Ports 4-14	—	—	—	—	Not Supported

Table 15. Data Port 1 and 3 Options

DATA PORT OPTIONS	PROVIDED
Implementation defined Interrupt 1	No
Implementation defined Interrupt 2	No
Implementation defined Interrupt 3	No
Flow Mode Support	Yes
Extended Buffer Operating Modes for Flow Control	No
Block Group Support	No
Prepare State Machine	Advanced

Interrupts

The device supports individually enabled status interrupts for sending feedback to the host about events that have occurred on-chip. When enabled, interrupts are transmitted on the IRQ output in I2C control mode and through the SoundWire slave interface in SoundWire control mode.

Interrupt Bit Field Composition

Each interrupt source has five individual bit field components. The function of each component is detailed below and the corresponding bit fields for each source can be identified by the appended suffix (shown in parentheses).

Raw Status (RAW)

Each interrupt source has a read-only bit to indicate the real-time raw status of the interrupt source.

State (STATE)

Each interrupt source has a read-only state bit that is set whenever a rising edge occurs on the associated raw status bit. The state bit is set regardless of the setting of the source enable bit.

Flag (FLAG)

Each interrupt source has a read-only flag bit. If the source enable bit is set, then the flag bit is set, and an interrupt can be generated whenever the source state bit is set.

Enable (EN)

Each interrupt source has a dynamic read/write enable bit. When the enable bit is set, the associated flag bit is set, and an interrupt can be generated whenever the source state bit is set.

Clear (CLR)

Each interrupt source has a dynamic write-only clear bit. Writing a 1 to a clear bit resets the associated state and flag bits to 0. Writing a 0 to a clear bit has no effect. In I2C control mode, the IRQ output is deasserted if all flag bits are 0.

IRQ Output Configuration

The device allows the user to configure the drive mode and polarity of the IRQ output. The IRQ_MODE bit controls the drive mode. If IRQ_MODE is 0, the pin is configured as an open-drained output and requires an external pullup resistor. If IRQ_MODE is 1, then IRQ is configured as a push-pull CMOS output.

The IRQ_POL bit controls the polarity of the IRQ bus. Interrupt events (a flag bit is set high) assert the IRQ bus low if IRQ_POL = 0 and high if IRQ_POL = 1. The IRQ bus deasserts if all flag bits are cleared (set low).

Interrupt Sources

The events in [Device Interrupt Sources](#) can cause device interrupts when enabled (corresponding interrupt enable set high).

IRQ Bus Configuration

REGISTER ADDRESS = 0x2010					DESCRIPTION
BIT	PoR	BIT NAME	TYPE	RES	
7	0	RESERVED	—	—	Unused Returns 0 if read.
6	0				
5	0				
4	0				
3	0				
2	0	IRQ_MODE	RW-R	IRQ	IRQ Mode Controls the drive mode of the IRQ Output. 0 = Open-drain output (an external pullup resistor is necessary) 1 = CMOS push-pull output
1	0	IRQ_POL	RW-R	IRQ	IRQ Polarity Controls the IRQ bus polarity. 0 = Low when any interrupt FLAG bits are high 1 = High when any interrupt FLAG bits are high
0	0	IRQ_EN	RW-D	—	IRQ Enable Enables the IRQ Output. 0 = IRQ output is disabled and is high-impedance 1 = IRQ output is enabled and is controlled by the interrupt controller

Device Interrupt Sources

REGISTER ADDRESS	INTERRUPT SOURCES	BIT FIELD	DESCRIPTION
0x2001 0x2004 0x2007 0x200A 0x200D	BDE Active Begin Event	BDE_ACTIVE_BGN_*	Indicates that the BDE is active.
	BDE Active End Event	BDE_ACTIVE_END_*	Indicates that the BDE is no longer active.
	BDE Level Change Event	BDE_LEVEL_*	Indicates that the BDE has transitioned between thresholds.
	BDE Level 4 Event	BDE_L4_*	Indicated that the BDE has transitioned into level 4.
	Thermal Warning Begin Event	THERMWARN_BGN_*	Indicates when the thermal-warning threshold has been exceeded.
	Thermal Warning End Event	THERMWARN_END_*	Indicates that the die temperature was previously above the thermal-warning threshold and has now dropped below the threshold.
	Thermal Shutdown Begin Event	THERMSHDN_BGN_*	Indicates when the thermal-shutdown threshold has been exceeded.
Thermal Shutdown End Event	THERMSHDN_END_*	Indicates that the die temperature was previously above the thermal-shutdown threshold and has now dropped below the threshold.	
0x2002 0x2005 0x2008 0x200B 0x200E	ICC Data Error	ICC_DATA_ERR_*	Indicates that the ICC synchronization lock for the assigned group was broken due to incorrect data.
	ICC Synchronization Error	ICC_SYNC_ERR_*	Indicates that the device has not synchronized within the ICC time-out period from when the ICC interface was enabled.
	Clock Monitor Start Event	CLKSTART_*	Indicates that the clock monitor has detected a restart of clock.
	Clock Monitor Stop Event	CLKSTOP_*	Indicates that the clock monitor has detected a loss of clock.
	Speaker Over Current Event	SPK_OVC_*	Indicates that the speaker amplifier current limit has been exceeded.
	Power-Up Done Event	PWRUP_DONE_*	Indicates when the device has completed power-up successfully.
	Power-Down Done Event	PWRDN_DONE_*	Indicates when the device has completed power-down.
	OTP Load Fail Event	OTP_FAIL_*	Indicates when the OTP load routine that runs when exiting hardware shutdown has failed to complete successfully.

Device Interrupt Sources (continued)

REGISTER ADDRESS	INTERRUPT SOURCES	BIT FIELD	DESCRIPTION
0x2003 0x2006 0x2009 0x200C 0x200F	Limiter Active Begin Event	LMTR_ACTIVE_BGN_*	Indicates that the limiter circuit is applying a hard limit (infinite compression) to the signal.
	Limiter Active End Event	LMTR_ACTIVE_END_*	Indicates that the limiter circuit has stopped applying a hard limit (infinite compression) to the signal.
	DHT Active Begin Event	DHT_ACTIVE_BGN_*	Indicates that the DHT circuit is active and is applying compression to the signal.
	DHT Active End Event	DHT_ACTIVE_END_*	Indicates that the DHT circuit has stopped applying compression to the signal.
	Thermal Foldback Begin Event	THERMFB_BGN_*	Indicates die temperature is above thermal-foldback threshold and device is attenuating the output.
	Thermal Foldback End Event	THERMFB_END_*	Indicates die temperature is below thermal-foldback threshold and device has stopped attenuating the output.
	PVDD UVLO Shutdown Event	PVDD_UVLO_SHDN_*	Indicates that PVDD has dropped below the minimum allowed voltage after initial power-up is complete.

Note: The bit fields are shown without the component suffixes. For example, *BDE_LEVEL_** refers to *BDE_LEVEL_RAW*, *BDE_LEVEL_STATE*, *BDE_LEVEL_FLAG*, *BDE_LEVEL_EN*, and *BDE_LEVEL_CLR*. All Interrupt sources have these five component bit fields.

Digital Output Pin Drive Strength

The drive strength control (*_DRV) bits set the drive strengths of the logic output pins. Four different CMOS drive strengths are available for each logic output ([Digital Output Pin Drive Strength Configuration](#)).

Digital Output Pin Drive Strength Configuration

REGISTER ADDRESS = 0x201E					DESCRIPTION
BIT	PoR	BIT NAME	TYPE	RES	
7	0	ICC_DRV[1:0]	RW-S	EN	ICC Drive Strength Control Configures the output drive strength of ICC. 00 = Reduced drive mode 01 = Normal drive mode 10 = High drive mode 11 = Highest drive mode
6	1				
5	0	LRCLK_DRV[1:0]	RW-S	EN	LRCLK Drive Strength Control Configures the output drive strength of LRCLK. 00 = Reduced drive mode 01 = Normal drive mode 10 = High drive mode 11 = Highest drive mode
4	1				
3	0	IRQ_DRV[1:0]	RW-S	EN	IRQ Drive Strength Control Configures the output drive strength of IRQ. 00 = Reduced drive mode 01 = Normal drive mode 10 = High drive mode 11 = Highest drive mode
2	1				
1	0	DOUT_DRV[1:0]	RW-S	EN	DOUT Drive Strength Control Configures the output drive strength of DOUT. 00 = Reduced drive mode 01 = Normal drive mode 10 = High drive mode 11 = Highest drive mode
0	1				

Tone Generator

The device includes a tone generator, which can be used to generate sinewave tones or DC output levels. The tone generator requires a valid interface clocking configuration. However, for tone generator operation the selected audio sample rate set by the SPK_SR bit field ([Speaker Path Sample Rate](#)) cannot exceed 48kHz.

The tone generator output is configured with the TONE_CONFIG bit field ([Tone Generator Configuration](#)). If a sinewave tone output is selected, then the frequency

is set by the audio sample rate (selected by SPK_SR) divided by the selected ratio. If a DC output is selected, it does not vary with the audio sample rate.

When the tone generator is enabled (TONE_CONFIG bit field is any setting except 0x00), the tone generator output is routed to the speaker path. When its disabled (TONE_CONFIG = 0x00), the speaker path input is set to either the PCM or SoundWire compatible interface (whichever is active).

Tone Generator Configuration

REGISTER ADDRESS = 0x2040					DESCRIPTION
BIT	PoR	BIT NAME	TYPE	RES	
7	0	RESERVED	—	—	Unused Returns 0 if read.
6	0				
5	0				
4	0				
3	0	TONE_CONFIG[3:0]	RW-R	SFB	Tone Generator Configuration Configures the output of the tone generator. For signal outputs, the frequency is a division of the sample rate (f_S). 0000 = Disabled 0001 = $f_S/4$ (at 48kHz = 12kHz) 0010 = $f_S/6$ (at 48kHz = 8kHz) 0011 = $f_S/8$ (at 48kHz = 6kHz) 0100 = $f_S/16$ (at 48kHz = 3kHz) 0101 = $f_S/32$ (at 48kHz = 1.5kHz) 0110 = $f_S/64$ (at 48kHz = 750Hz) 0111 = $f_S/128$ (at 48kHz = 375kHz) 1000 = DC Zero Code (0x0000) 1001 = DC Positive Half Scale (0x4000) 1010 = DC Negative Half Scale (0xC000) 1011 to 1111 = Reserved
2	0				
1	0				
0	0				

Speaker Path Configuration

The source input data to the speaker amplifier path is routed from either the PCM interface, the SoundWire compatible interface, or the tone generator. The data is then routed through digital filters, signal processing, and volume/gain control blocks before reaching the Class D speaker amplifier (shown in [Figure 22](#)).

Speaker Path Dither

The input data to the speaker path can optionally have dither (± 1 LSB peak-to-peak) applied if SPK_DITH_EN ([Speaker Path DSP Configuration](#)) is set to 1. No dither is applied when SPK_DITH_EN is set to 0.

Speaker Path Data Inversion

The input data to the speaker path can optionally be inverted by setting the DAC_INVERT bit ([Speaker Path DSP Configuration](#)) to 1.

Speaker Path DC Blocking Filter

A DC blocking filter can be enabled on the speaker path by setting the SPK_DCBLK_EN bit ([Speaker Path DSP Configuration](#)) to 1.

Speaker Path Digital Volume Control

The device provides a dynamically programmable speaker path digital volume control. The digital volume control provides an attenuation range of 0dB to -63dB in 0.5dB steps that is configured with the SPK_VOL bit field ([Speaker Path Digital Volume Control](#)). A digital mute is also provided, and is enabled when SPK_VOL is set to 0x7F. The digital volume control can be placed either before or after the limiter in the signal path with the SPK_VOL_SEL bit.

Digital volume ramping during speaker path start up, speaker path shutdown, and digital mute (SPK_VOL = 0x7F) is enabled by default. However, both the volume ramp up and ramp down can be individually bypassed with the SPK_VOL_RMPUP_BYPASS and SPK_VOL_RMPDN_BYPASS bit fields respectively ([Speaker Path DSP Configuration](#)). When volume ramp up or ramp down is enabled, the device turn-on and turn-off times are longer.

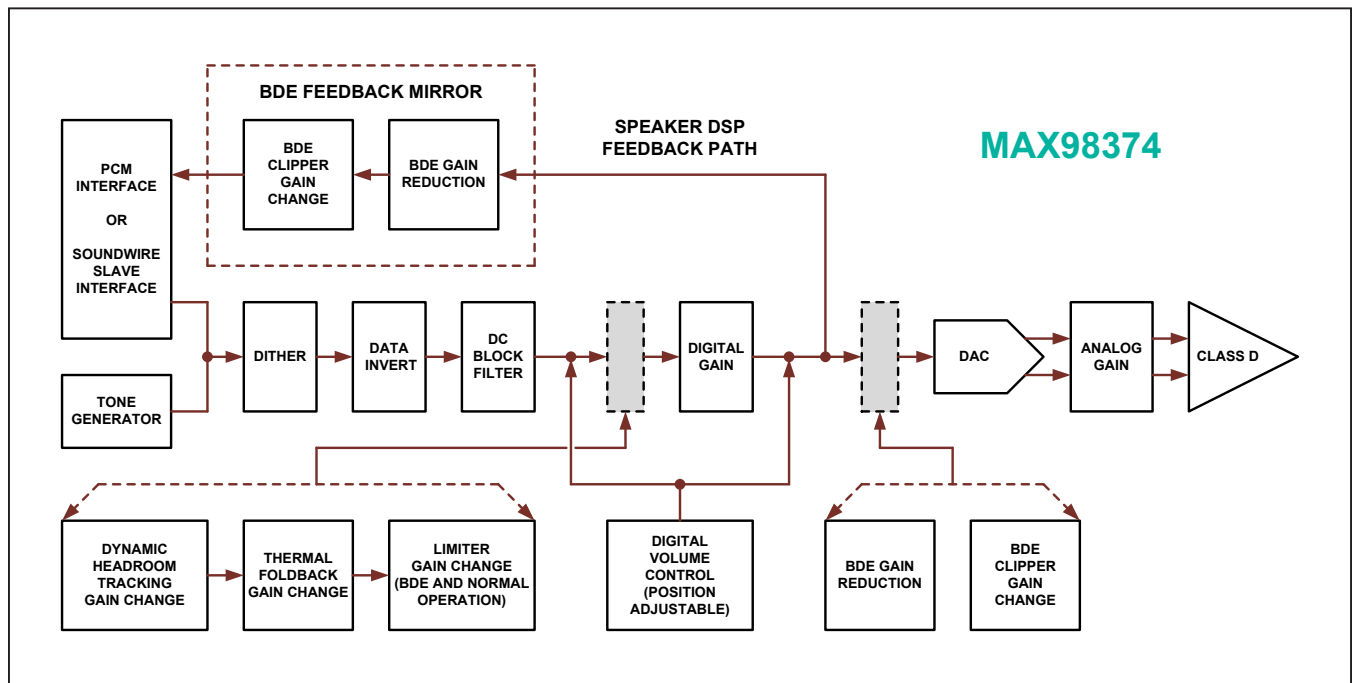

Figure 22. Speaker Path Block Diagram

Speaker Path Digital Gain Control

The device provides a programmable speaker path digital gain control. The digital gain control provides a range of 0dB to +6dB in 0.5dB steps that is configured with the SPK_GAIN bit field ([Speaker Path Output Level Scaling](#)). Unlike the digital volume control, the digital gain setting cannot be dynamically changed.

Speaker Path DSP Data Feedback Path

The speaker path DSP data can be routed from just before the DAC input back to the PCM interface, and can be assigned to any valid data output channel ([PCM Interface Data Output Speaker DSP Feedback Channel Source](#)). The speaker path DSP data feedback path is enabled with the SPK_FB_EN bit ([Speaker Path and Speaker DSP Data Feedback Path Enables](#)).

Speaker Path Maximum Peak Output-Voltage Scaling

The device operates over a large PVDD supply-voltage range, and as a result, the full-scale speaker output amplitude level is configurable to allow the output signal amplitude to be scaled. As a baseline, the full-scale output of

the speaker path DAC is 3.68dBV (typical). The speaker path no-load maximum peak output-voltage level (V_{MPO}) is then programmable relative to this baseline level. The peak output scaling range is from +8dB to +17dB and is set with the SPK_GAIN_MAX bit field ([Speaker Path Output Level Scaling](#)).

The speaker output signal level (in dBV) for a given digital input signal level (in dBFS) is calculated as follows:

$$\text{Output Signal Level (dBV)} = \text{Input Signal Level (dBFS)} + 3.68 \text{ (dBV)} + \text{SPK_GAIN_MAX (dB)}$$

(0dBFS is referenced to 0dBV)

The peak output-voltage scaling is applied to the signal path using a combination of digital gain and analog gain adjustments (See [Figure 22](#)). The analog gain adjustments are coarse and come in 3dB steps. As a result, single dB digital gain steps are automatically subtracted from the analog gain steps to provide the 1dB resolution for the peak output voltage-level configuration (SPK_GAIN_MAX). [Table 16](#) shows the combination of analog gain and digital gain levels that are paired for each peak output-voltage level setting.

Table 16. Maximum Peak Output-Voltage Scaling Configuration

SPK_GAIN_MAX	TOTAL GAIN (dB)	DIGITAL GAIN (dB)	ANALOG GAIN (dB)	MAXIMUM PEAK VOLTAGE (V_p)
0x0	8	-2	10	5.43 (11.68dBV)
0x1	9	-1	10	6.09 (12.68dBV)
0x2	10	0	10	6.83 (13.68dBV)
0x3	11	-2	13	7.67 (14.68dBV)
0x4	12	-1	13	8.60 (15.68dBV)
0x5	13	0	13	9.65 (16.68dBV)
0x6	14	-2	16	10.83 (17.68dBV)
0x7	15	-1	16	12.15 (18.68dBV)
0x8	16	0	16	13.63 (19.68dBV)
0x9	17	-2	19	15.29 (20.68dBV)

Speaker Path DSP Configuration

REGISTER ADDRESS = 0x203F					DESCRIPTION
BIT	PoR	BIT NAME	TYPE	RES	
7	0	SPK_VOL_SEL	RW-R	SFB	Speaker Path Digital Volume Control Location Select Controls where in the speaker amplifier digital signal path the digital volume is applied. 0 = Digital volume control applied before BDE limiter 1 = Digital volume control applied after BDE limiter
6	0	RESERVED	—	—	Unused Returns 0 if read.
5	0	SPK_INVERT	RW-R	SFB	Speaker Path Output Invert Inverts the speaker amplifier path output. 0 = Output is normal 1 = Output is inverted
4	0	RESERVED	—	—	Unused Returns 0 if read.
3	0	SPK_VOL_RMPDN_BYPASS	RW-R	SFB	Speaker Path Volume Ramp-Down Bypass Controls whether the speaker amplifier path volume is internally ramped down during shutdown. 0 = Volume ramp enabled 1 = Volume ramp bypassed
2	0	SPK_VOL_RMPUP_BYPASS	RW-R	SFB	Speaker Path Volume Ramp-Up Bypass Controls whether the speaker amplifier path volume is internally ramped up during startup. 0 = Volume ramp enabled 1 = Volume ramp bypassed
1	1	SPK_DITH_EN	RW-R	SFB	Speaker Path Dither Enable Selects whether or not dither is applied to the PCM input data for the speaker amplifier path. 0 = Dither disabled 1 = Dither enabled
0	0	SPK_DCBLK_EN	RW-R	SFB	Speaker Path DC Blocking Filter Enable Controls the DC blocking filter in the speaker amplifier path. 0 = DC blocking filter disabled 1 = DC blocking filter enabled

Speaker Path Digital Volume Control

REGISTER ADDRESS = 0x203D					DESCRIPTION
BIT	PoR	BIT NAME	TYPE	RES	
7	0	RESERVED	—	—	Unused Returns 0 if read.
6	0	SPK_VOL[6:0]	RW-D	—	Speaker Path Digital Volume Control Sets the digital volume level of speaker amplifier path. 0x00 = 0.0dB 0x01 = -0.5dB 0x02 = -1.0dB ... = ... (-0.5dB steps) 0x7C = -62.0dB 0x7D = -62.5dB 0x7E = -63.0 dB 0x7F = Mute
5	0				
4	0				
3	0				
2	0				
1	0				
0	0				

Speaker Path Output Level Scaling

REGISTER ADDRESS = 0x203E					DESCRIPTION
BIT	PoR	BIT NAME	TYPE	RES	
7	0	SPK_GAIN[3:0]	RW-R	SFB	Speaker Digital Gain Control Sets the digital gain level of the speaker amplifier path. 0000: 0.0dB 0110: 3.0dB 0001: 0.5dB 0111: 3.5dB 0010: 1.0dB 1000: 4.0dB 0011: 1.5dB 1001: 5.0dB 0100: 2.0dB 1010: 6.0dB 0101: 2.5dB 1011 to 1111: Reserved
6	0				
5	0				
4	0				
3	1	SPK_GAIN_MAX[3:0]	RW-R	SFB	Speaker Full-Scale Gain Maximum Control Sets the maximum peak output-voltage level (V _{MPO}) for the speaker path (no-load). Values in dB are relative to the baseline speaker path DAC full-scale output level of 3.68dBV. 0000: 5.43V _P (+8dB) 0110: 10.83V _P (+14dB) 0001: 6.09V _P (+9dB) 0111: 12.15V _P (+15dB) 0010: 6.83V _P (+10dB) 1000: 13.63V _P (+16dB) 0011: 7.66V _P (+11dB) 1001: 15.29V _P (+17dB) 0100: 8.60V _P (+12dB) 1010 – 1111: Reserved 0101: 9.65V _P (+13dB)
2	0				
1	0				
0	0				

Class D Speaker Amplifier Output Stage

The device features a Class D speaker amplifier output stage with AEL and SSM. The speaker's amplifier path is enabled and disabled using the SPK_EN bit ([Speaker Path and Speaker DSP Data Feedback Path Enables](#)). The default Class D amplifier switching frequency is 472kHz, and results in the best THD+N performance. However, the output switching frequency is programmable and can be reduced to 330kHz by setting the SPK_FSW_SEL bit field ([Speaker Amplifier Configuration](#)) to 1. The reduced switching frequency setting trades an improvement in amplifier efficiency for a reduction in THD+N performance.

Speaker Amplifier Clock Synchronization

By default, the device uses the externally provided BCLK/SWCLK as the synchronous clock source for the Class D amplifier operation. However, if the SPK_OSC_SEL bit ([Speaker Amplifier Configuration](#)) is set to 1, then an asynchronous internal oscillator is enabled and is used to derive the Class D amplifier clocking.

Speaker Amplifier Ultra-Low EMI Filterless Operation

Traditional Class D amplifiers require the use of external LC filters, or shielding, to meet electromagnetic-interference (EMI) regulation standards. However, the device features AEL which helps limit the output switching harmonics that can directly contribute to EMI and radiated emissions. As a result, the device does not require an output filter in typical applications with half power and a load length of less than 6 inches long ([Figure 23](#)). For applications with higher power or longer load lengths, a ferrite bead may be required to meet the EMC standard EN 55022 Class B ([Figure 24](#)).

The programmable speaker edge rate control is used to adjust the switching edge rate to help tune EMI performance. As the edge rate increases, the efficiency improves slightly, while as the edge rate is decreased

the efficiency drops slightly. The speaker edge rate is configured with the SPK_EDGE_CTRL bit field ([Speaker Amplifier Switching Edge Rate Configuration](#)).

The Class D speaker amplifier output also supports spread spectrum modulation (SSM). In most systems, SSM is not needed and therefore it is not enabled by default. When SSM is enabled (SPK_SSM_EN = 1, [Speaker Amplifier Configuration](#)), it optimizes the suppression and control of the output switching harmonics that can contribute to EMI and radiated emissions. The modulation index in spread-spectrum mode is controlled by the SPK_SSM_MOD_INDEX bit field ([Speaker Amplifier Configuration](#)), and the maximum modulation index (MMI) varies accordingly. Higher percentage settings of the modulation index result in the switching frequency of the amplifier being modulated by a wider range, spreading out-of-band energy across a wider bandwidth. Above 10MHz, the wideband spectrum looks like noise for EMI purposes.

Speaker Amplifier Current Limit

The device features amplifier current-limit protection that protects the amplifier output from both high current and short circuit events. If the OVC_AUTORESTART_EN bit ([Device Auto-Restart Configuration](#)) is set to 1 and the speaker amplifier output current exceeds the current-limit threshold (6A typ), the device generates an interrupt and disables the amplifier output. After 69 (typically) Class D clock cycles, the amplifier output is re-enabled. If the overcurrent condition still exists, the device continues to disable and re-enable the amplifier output automatically until the fault condition is removed.

If the OVC_AUTORESTART_EN bit is set to 0, when a speaker amplifier overcurrent event occurs the device still generates an interrupt and disables the amplifier output. However, in this case the device is placed into software shutdown and the software enable (EN, [Global Enable](#)) bit is set to 0. As a result, the host must manually re-enable the device after an overcurrent event.

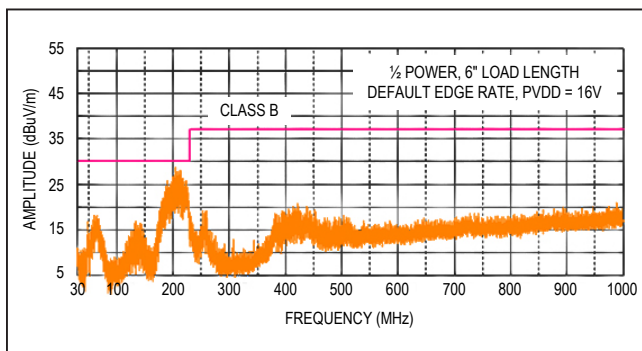

Figure 23. Filterless EMI results for EN 55022 Class B Standard

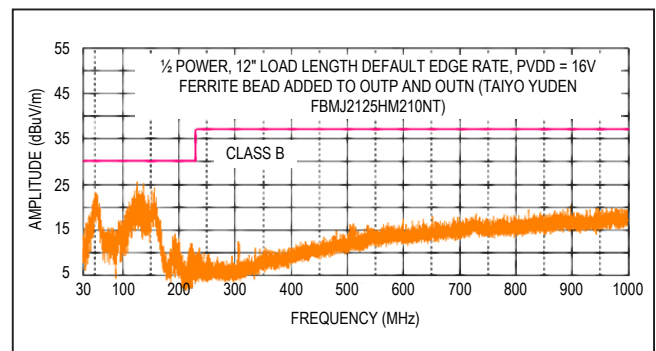

Figure 24. Filtered Output EMI results for EN 55022 Class B Standard

Speaker Path and Speaker DSP Data Feedback Path Enables

REGISTER ADDRESS = 0x2043					DESCRIPTION
BIT	PoR	BIT NAME	TYPE	RES	
7	0	RESERVED	—	—	Unused Returns 0 if read.
6	0				
5	0				
4	0				
3	0				
2	0				
1	0	SPK_FB_EN	RW-D	—	Speaker DSP Feedback Path Enable Enables the output path from the end of the amplifier baseband programming to the host through the PCM interface. 0 = Speaker DSP feedback path disabled 1 = Speaker DSP feedback path enabled
0	0	SPK_EN	RW-D	—	Speaker Path Enable Enable output amplifier path. The speaker amplifier is powered up if this bit is set and the global enable bit is set. 0 = Speaker amplifier is disabled 1 = Speaker amplifier is enabled

Speaker Amplifier Switching Edge Rate Configuration

REGISTER ADDRESS = 0x2042					DESCRIPTION
BIT	PoR	BIT NAME	TYPE	RES	
7	0	RESERVED	—	—	Unused Returns 0 if read.
6	0				
5	0				
4	0				
3	0				
2	0	SPK_EDGE_CTRL[1:0]	—	SPK	Speaker Amplifier Edge Rate Control Controls the OUTP and OUTN switching edge rates. Values are relative to the default setting (00), and are based on a 10% to 90% measurement. 00 = 30ns typical rise/fall time at $V_{PVDD} = 12V$ (default) 01 = 13% slower rise/fall time 10 = 32% slower rise/fall time 11 = 10% faster rise/fall time
1	0				
0	0	RESERVED	—	—	Unused Returns 0 if read.

Speaker Amplifier Configuration

REGISTER ADDRESS = 0x2041					DESCRIPTION
BIT	PoR	BIT NAME	TYPE	RES	
7	0	SPK_SSM_EN	RW-R	SPK	Speaker Amplifier SSM Enable Enables spread-spectrum clocking. 0 = Spread-spectrum clocking is disabled 1 = Spread-spectrum clocking is enabled
6	0	SPK_OSC_SEL	RW-R	SPK	Speaker Amplifier Clock Source Select Selects Class D amplifier clock source. 0 = Class D clock is synchronous to BCLK or SWCLK. 1 = Class D clock source is an asynchronous internal oscillator
5	0	RESERVED	—	—	Unused Returns 0 if read.
4	0				
3	0	SPK_FSW_SEL	RW-R	SPK	Speaker Amplifier Switching Frequency Select Controls the nominal switching frequency of the Class D amplifier: 0 = 472kHz 1 = 330kHz
2	0	SPK_SSM_MOD_INDEX[2:0]	RW-R	SPK	Speaker Amplifier SSM Index Selects the modulation index for the Class D amplifier spread-spectrum clocks. The modulation index can be varied as follows: 000 = MMI 001 = MMI x 5/6 010 = MMI x 4/6 011 = MMI x 3/6 (recommended for 330kHz operation) 100 = MMI x 2/6 101 = MMI x 1/6 (recommended for 472kHz operation) 110 to 111 = Reserved
1	1				
0	1				

Measurement ADC

The device features a configurable 8-bit measurement ADC. The measurement ADC has two channels, one for die temperature measurement (measurement ADC thermal channel) and the other for PVDD supply voltage measurement (measurement ADC PVDD channel). The programmable measurement ADC sample rate is identical for all channels, and supports a range from 48kHz to 333kHz. Each channel separately provides an optional programmable lowpass IIR filter.

Measurement ADC Thermal Channel

When the device is clocked, active (EN = 1), and the speaker amplifier is enabled (SPK_EN = 1), the measure-

ment ADC thermal channel automatically activates. When active, it continuously measures and reports the device die temperature over the range from -29°C to +150.2°C.

The output of the thermal ADC channel can be read-back through the MEAS_ADC_THERM_DATA bit field ([Measurement ADC Thermal Channel Readback](#)) and is the input to both the thermal protection and thermal-foldback blocks. The thermal ADC channel also provides an optional lowpass IIR filter with a programmable bandwidth that scales relative to the measurement ADC sample rate. The filter is enabled with the MEAS_ADC_TEMP_FILT_EN bit field and the bandwidth is set with the MEAS_ADC_TEMP_FILT_COEFF bit field ([Measurement ADC Thermal Channel Filter Configuration](#)).

Measurement ADC Thermal Channel

When the device is clocked, active (EN = 1), and the speaker amplifier is enabled (SPK_EN = 1), the measurement ADC thermal channel automatically activates. When active, it continuously measures and reports the device die temperature over the range from -29°C to +150.2°C.

The output of the thermal ADC channel can be read-back through the MEAS_ADC_THERM_DATA bit field ([Measurement ADC Thermal Channel Readback](#)) and

is the input to both the thermal protection and thermal-foldback blocks. The thermal ADC channel also provides an optional lowpass IIR filter with a programmable bandwidth that scales relative to the measurement ADC sample rate. The filter is enabled with the MEAS_ADC_TEMP_FILT_EN bit field and the bandwidth is set with the MEAS_ADC_TEMP_FILT_COEFF bit field ([Measurement ADC Thermal Channel Filter Configuration](#)).

Measurement ADC Sample Rate Control

REGISTER ADDRESS = <u>0x2051</u>					DESCRIPTION
BIT	PoR	BIT NAME	TYPE	RES	
7	0	RESERVED	—	—	Unused Returns 0 if read.
6	0				
5	0				
4	0				
3	0				
2	0				
1	0	MEAS_ADC_SR[1:0]	RW-S	EN	Measurement ADC Channel Sample Rate Configures the sample rate of the measurement ADC channels. 00 = 333 kHz 01 = 192 kHz 10 = 64 kHz 11 = 48 kHz
0	0				

Measurement ADC Thermal Channel Readback

REGISTER ADDRESS = <u>0x2055</u>					DESCRIPTION
BIT	PoR	BIT NAME	TYPE	RES	
7	0	MEAS_ADC_THERM_DATA[7:0]	R	—	Measurement ADC Thermal Channel Result Provides the measured temperature value. To convert the 8-bit code into a real temperature, use the following: Measured temperature (°C) = (MEAS_ADC_THERM_DATA[7:0] x 1.28°C) - 29°C
6	0				
5	0				
4	0				
3	0				
2	0				
1	0				
0	0				

Measurement ADC PVDD Channel

When the device is clocked, active (EN = 1), and the speaker amplifier is enabled (SPK_EN = 1), the measurement ADC PVDD channel can be enabled. The PVDD channel is manually enabled by setting the MEAS_ADC_PVDD_EN bit to 1 ([Measurement ADC PVDD Channel Enable](#)) and is automatically enabled if the DHT or BDE are enabled. When the channel is enabled, it continuously measures and reports the PVDD supply voltage level over the range of 5.35V to 16.15V.

The output of the measurement ADC PVDD channel can be readback through the MEAS_ADC_PVDD_DATA bit field ([Measurement ADC PVDD Channel Readback](#)) and is routed to the DHT and BDE. The PVDD channel also provides an optional lowpass IIR filter with a programmable bandwidth that scales relative to the measurement ADC sample rate. The filter is enabled with the MEAS_ADC_PVDD_FILT_EN bit and the bandwidth is set with the MEAS_ADC_PVDD_FILT_COEFF bit field ([Measurement ADC PVDD Channel Filter Configuration](#)).

Measurement ADC Thermal Channel Filter Configuration

REGISTER ADDRESS = 0x2053					DESCRIPTION					
BIT	PoR	BIT NAME	TYPE	RES						
7	0	RESERVED	—	—	Unused Returns 0 if read.					
6	0									
5	0									
4	0	MEAS_ADC_TEMP_FILT_EN	RW-S	EN	Measurement ADC Thermal Channel Filter Enable Controls whether filtering is applied to the thermal channel output. 0 = Filter is bypassed 1 = Filter is applied					
3	0	RESERVED	—	—	Unused Returns 0 if read.					
2	0									
1	0	MEAS_ADC_TEMP_FILT_COEFF[1:0]	RW-S	EN	Measurement ADC Thermal Channel Filter Configuration Sets the thermal channel IIR lowpass filter bandwidth relative to the measurement ADC sample rate.					
0	0					SETTING	MEASUREMENT ADC CHANNEL SAMPLE RATE			
							48kHz	64kHz	192kHz	333kHz
						00	0.24kHz	0.33kHz	1.0kHz	1.7kHz
						01	0.49kHz	0.66kHz	2.0kHz	3.4kHz
		10	0.75kHz	1.0kHz	3.0kHz	5.2kHz				
11	1.0kHz	1.4kHz	4.1kHz	7.0kHz						

Measurement ADC PVDD Channel Readback

REGISTER ADDRESS = 0x2054					DESCRIPTION
BIT	PoR	BIT NAME	TYPE	RES	
7	0	MEAS_ADC_PVDD_DATA[7:0]	R	—	Measurement ADC PVDD Channel Result Provides the measured PVDD value. To convert the 8-bit code into a real voltage, use the following: Measured V_{PVDD} (V) = $(\text{MEAS_ADC_PVDD_DATA}[7:0] - 32) \times 0.075\text{V}$
6	0				
5	0				
4	0				
3	0				
2	0				
1	0				
0	0				

Measurement ADC PVDD Channel Filter Configuration

REGISTER ADDRESS = 0x2052					DESCRIPTION																													
BIT	PoR	BIT NAME	TYPE	RES																														
7	0	RESERVED	—	—	Unused Returns 0 if read.																													
6	0																																	
5	0																																	
4	0	MEAS_ADC_PVDD_FILT_EN	RW-S	EN	Measurement ADC PVDD Channel Filter Enable Controls whether filtering is applied to the PVDD channel output 0 = Filter is bypassed 1 = Filter is applied																													
3	0	RESERVED	—	—	Unused Returns 0 if read.																													
2	0																																	
1	0	MEAS_ADC_PVDD_FILT_COEFF[1:0]	RW-S	EN	Measurement ADC PVDD Channel Filter Configuration Sets the PVDD channel IIR lowpass filter bandwidth relative to the measurement ADC sample rate.																													
0	0				<table border="1"> <thead> <tr> <th rowspan="2">SETTING</th> <th colspan="4">MEASUREMENT ADC CHANNEL SAMPLE RATE</th> </tr> <tr> <th>48kHz</th> <th>64kHz</th> <th>192kHz</th> <th>333kHz</th> </tr> </thead> <tbody> <tr> <td>00</td> <td>0.24kHz</td> <td>0.33kHz</td> <td>1.0kHz</td> <td>1.7kHz</td> </tr> <tr> <td>01</td> <td>0.49kHz</td> <td>0.66kHz</td> <td>2.0kHz</td> <td>3.4kHz</td> </tr> <tr> <td>10</td> <td>0.75kHz</td> <td>1.0kHz</td> <td>3.0kHz</td> <td>5.2kHz</td> </tr> <tr> <td>11</td> <td>1.0kHz</td> <td>1.4kHz</td> <td>4.1kHz</td> <td>7.0kHz</td> </tr> </tbody> </table>	SETTING	MEASUREMENT ADC CHANNEL SAMPLE RATE				48kHz	64kHz	192kHz	333kHz	00	0.24kHz	0.33kHz	1.0kHz	1.7kHz	01	0.49kHz	0.66kHz	2.0kHz	3.4kHz	10	0.75kHz	1.0kHz	3.0kHz	5.2kHz	11	1.0kHz	1.4kHz	4.1kHz	7.0kHz
					SETTING		MEASUREMENT ADC CHANNEL SAMPLE RATE																											
						48kHz	64kHz	192kHz	333kHz																									
					00	0.24kHz	0.33kHz	1.0kHz	1.7kHz																									
01	0.49kHz	0.66kHz	2.0kHz	3.4kHz																														
10	0.75kHz	1.0kHz	3.0kHz	5.2kHz																														
11	1.0kHz	1.4kHz	4.1kHz	7.0kHz																														

Measurement ADC PVDD Channel Enable

REGISTER ADDRESS = 0x2056					DESCRIPTION
BIT	PoR	BIT NAME	TYPE	RES	
7	0	RESERVED	—	—	Unused Returns 0 if read.
6	0				
5	0				
4	0				
3	0				
2	0				
1	0				
0	0	MEAS_ADC_PVDD_EN	RW-D	—	Measurement ADC PVDD Channel Enable Manually enables the measurement ADC PVDD channel. 0 = PVDD channel disabled 1 = PVDD channel enabled

Clock Monitor

The device provides an optional clock monitor that is enabled by setting `CMON_EN` ([Device Auto-Restart Configuration](#)) to 1. When enabled, the block monitors the active clock source (BCLK in I²C control/PCM interface mode and SWCLK in SoundWire control mode) and automatically places the device into shutdown if a clock source error is detected. This prevents unwanted signals from reaching the speaker path output during a fault condition.

The clock monitor detects a clock source error if the monitored clock source (BCLK or SWCLK) stops high or low for more than 60µs (typ). The timeout of the clock monitor is determined by an internal oscillator, which has a typical variability of ±10% over the devices operating temperature range.

The clock monitor can be programmed to respond to the loss and reapplication of the clock source in two ways. When the `CMON_AUTORESTART_EN` bit ([Device Auto-Restart Configuration](#)) is set to 0 and a clock source error is detected, the clock monitor generates an interrupt (`CLKSTOP_*`) and places the device into software shut-

down by setting `EN` to 0. When a valid clock is reapplied, the clock monitor generates an interrupt (`CLKSTART_*`); however, the device remains in software shutdown until the host sets `EN` to 1.

When the `CMON_AUTORESTART_EN` bit is set to 1 and a clock source error is detected, the clock monitor generates an interrupt (`CLKSTOP_*`) and places the device into shutdown internally. When a valid clock is reapplied, the clock monitor generates an interrupt (`CLKSTART_*`) and the device automatically exits shutdown. The value of `EN` is not changed in auto restart mode, and remains 1 throughout the process. As a result, when auto restart is enabled, the device does not go through the full power-down/up sequence, and audible glitches may occur.

Clock Monitor in SoundWire Control Mode

If the SoundWire master uses ClockStop events, then the clock monitor should be disabled in SoundWire control mode. In this case, to prevent audible glitches, the SoundWire master should instead place the device into software shutdown directly prior to initiating a ClockStop event.

Device Auto-Restart Configuration

REGISTER ADDRESS = 0x20FE					DESCRIPTION
BIT	PoR	BIT NAME	TYPE	RES	
7	0	RESERVED	—	—	Unused Returns 0 if read.
6	0				
5	0				
4	0				
3	0	OVC_ AUTORESTART_EN	RW-S	EN	Speaker Amplifier Overcurrent Automatic Restart Enable Controls whether or not the speaker amplifier automatically re-enables after an overcurrent fault condition. 0 = Overcurrent recovery is in manual mode 1 = Overcurrent recovery is in auto mode
2	0	THERM_ AUTORESTART_EN	RW-S	EN	Thermal Shutdown Automatic Restart Enable Controls whether or not the device automatically resumes playback when the die temperature recovers from thermal shutdown. 0 = Thermal shutdown recovery is in manual mode 1 = Thermal shutdown recovery is in auto mode
1	0	CMON_ AUTORESTART_EN	RW-S	EN	Clock Monitor Automatic Restart Enable Controls whether or not the device automatically resumes playback when the clock returns after stopping. 0 = Device does not automatically restart when a valid clock is reapplied 1 = Device automatically restarts when a valid clock is reapplied
0	0	CMON_EN	RW-S	EN	Clock Monitor Enable Enable the clock monitor. 0 = Clock monitor disabled 1 = Clock monitor enabled

Dynamic Headroom Tracking (DHT)

The device features DHT to preserve consistent dynamic range in the presence of a varying supply. DHT maintains consistent volume and listening levels up to a programmable threshold below full scale (referred to as the rotation point or RP). DHT maintains the headroom of the amplifier at signal peaks that occur above the rotation point up to full scale to ensure consistent, smooth compression in the presence of supply variations.

DHT is enabled with the DHT_EN bit ([DHT Enable](#)). When DHT is enabled, the measurement ADC PVDD channel is automatically enabled and routed to the DHT block. The conversion results are used to calculate the amount of compression (if any) that is applied to signal peaks above the configured rotation point.

The DHT functionality is configured by several key parameters. The first is the speaker path full-scale gain maximum setting (SPK_GAIN_MAX, [Speaker Path Output Level Scaling](#)). This sets the no-load maximum peak output-voltage level (V_{MPO}) that the Class D amplifier reproduces with a full-scale (0dBFS) input signal. This level is compared to the current V_{PVDD} level to determine what the available headroom is. The second parameter is the DHT voltage rotation point (V_{RP}). The rotation point is selected with the DHT_VROT_PNT bit ([DHT Configuration](#)) and sets the level in dBFS above

which compression is applied to the output signal (when the V_{PVDD} voltage level drops below V_{MPO}). Finally, DHT uses the gain minimum parameter (DHT_SPK_GAIN_MIN, [DHT Configuration](#)) to control the maximum compression ratio (V_{MIN}). This parameter enables a second inflection point on the transfer function when the current V_{PVDD} level is below the V_{MIN} setting. In this case, the compression ratio does not increase any further and signals above the currently available headroom clips instead. Note that if the limiter block is enabled with DHT active, the output-voltage level is limited anytime the input signal to the limiter block exceeds the configured limiter threshold regardless of the DHT configuration and operating point.

DHT Modes of Operation

The DHT has three general modes of operation. The mode of operation depends on the V_{PVDD} level relative to the no-load maximum peak output-voltage level (V_{MPO}) and the selected rotation point (V_{RP}).

MODE 1: V_{PVDD} is greater than V_{MPO}

If V_{PVDD} is greater than V_{MPO} , then there is no action taken by the DHT block. There is sufficient headroom for the amplifier to linearly represent any signal up to and including 0dBFS; the signal transfer function is unaffected.

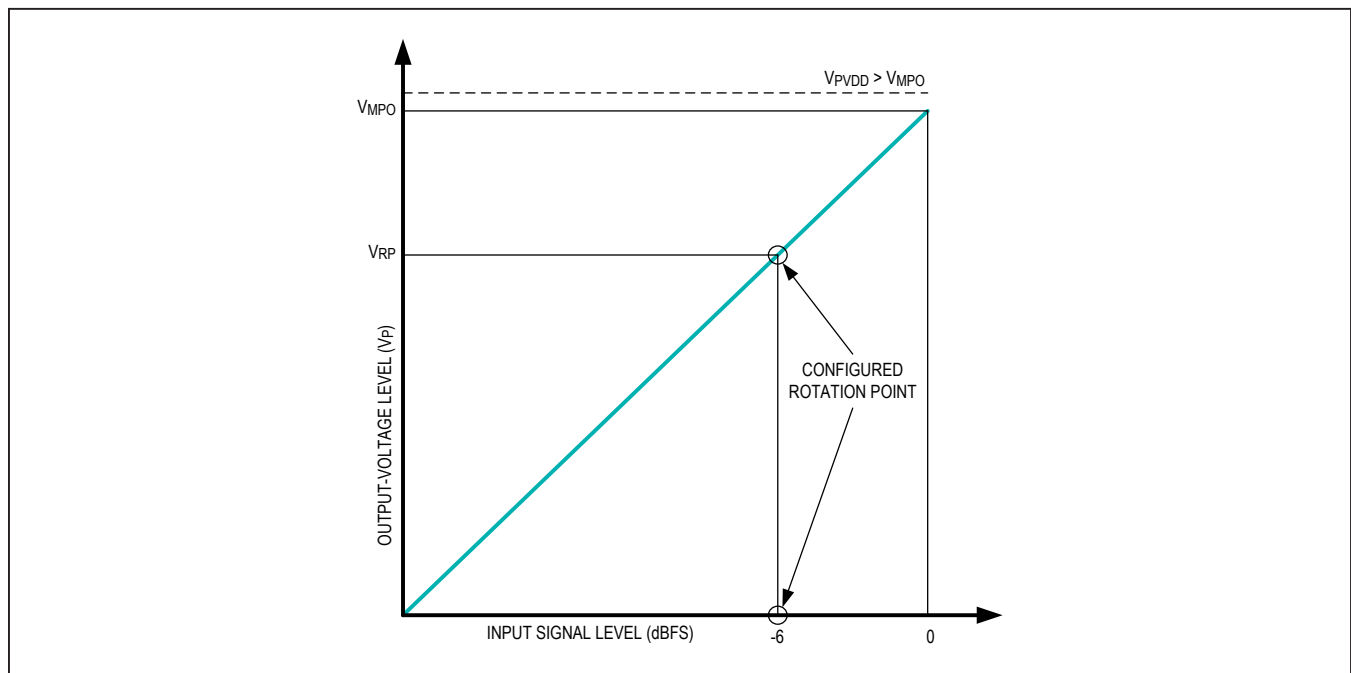

Figure 25. Example of DHT in Mode 1 Operation

MODE 2: V_{PVDD} is less than V_{MPO} and greater than V_{RP}

DHT operates in mode 2 when V_{PVDD} drops below V_{MPO} but remains above the rotation point (V_{RP}). The transfer function for signals below V_{RP} is exactly as in mode 1. However, signal levels between V_{RP} and full scale (0dBFS) are now subject to the calculated compression ratio.

The compression ratios in mode 2 are calculated from the combination of the current V_{PVDD} level, the rotation point (V_{RP}), the SPK_GAIN_MAX (V_{MPO}), and $DHT_SPK_GAIN_MIN$ (V_{MIN}) settings. DHT then applies the calculated ratio for peaks over V_{RP} at the programmed attack and release rates (see the [DHT Ballistics](#) section). [Figure 26](#) and [Figure 27](#) illustrate the mode 2 transfer function.

MODE 3a: V_{PVDD} is less than V_{RP} and greater than V_{MIN}

When the rotation point (V_{RP}) is set to a higher value than the current V_{PVDD} level, but V_{PVDD} still exceeds the configured V_{MIN} DHT operates in mode 3a. If V_{PVDD} is less than V_{RP} , then the effective rotation point must now be set by the current V_{PVDD} level. The device automatically determines this new rotation point and hard limiting (clipping) is applied to signal peaks exceeding it.

The rotation point (V_{RP}) should be selected so that this mode is never used. The rotation point typically should be set to reflect the lowest V_{PVDD} level expected.

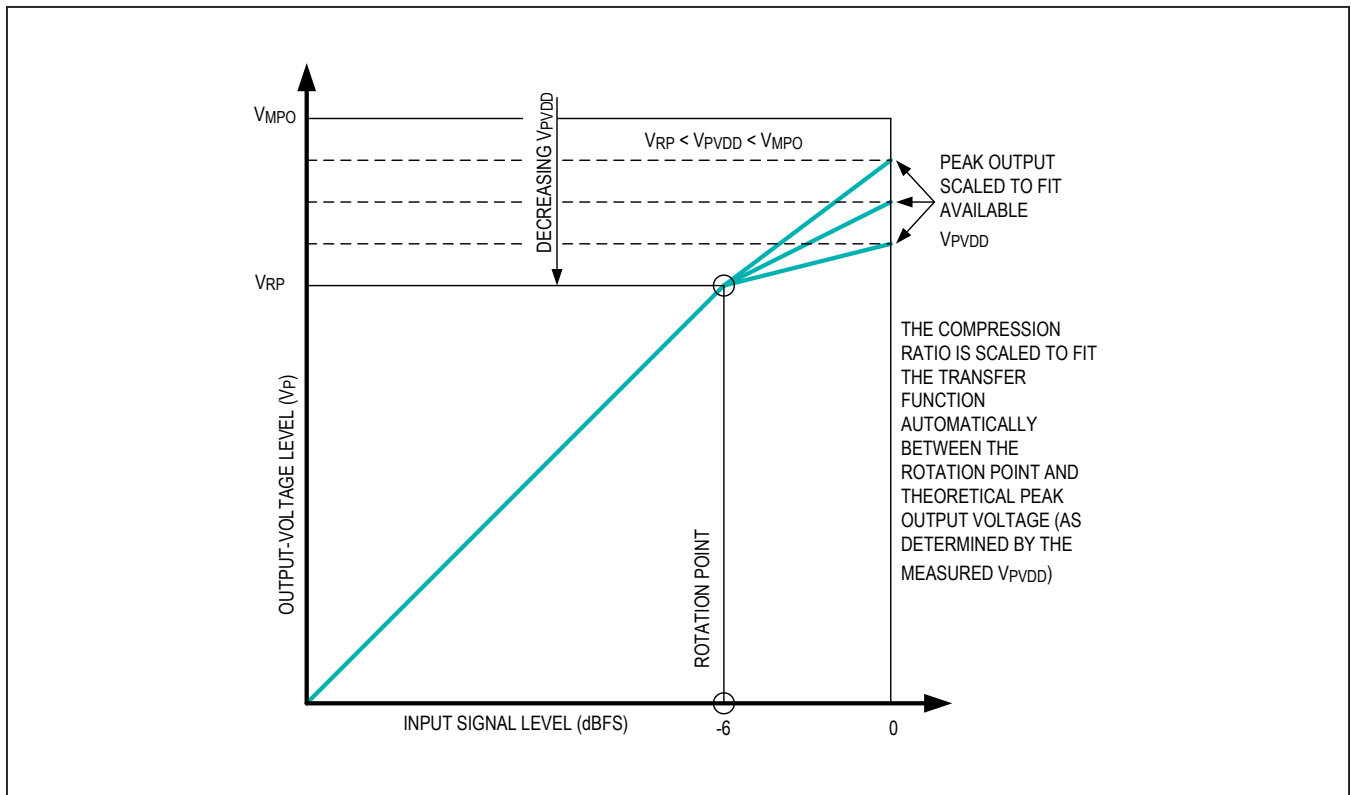

Figure 26. Example of DHT in Mode 2 Operation with $V_{RP} \geq V_{MIN}$

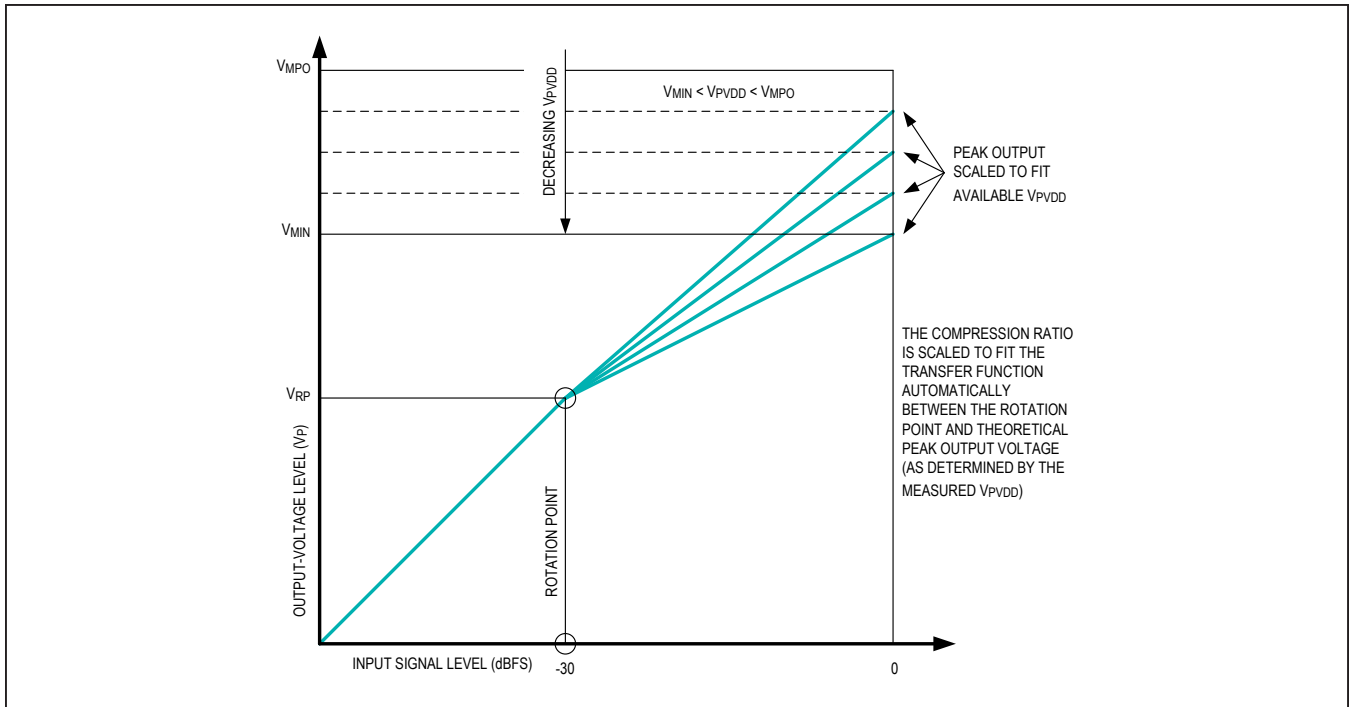

Figure 27. Example of DHT in Mode 2 Operation with $V_{RP} < V_{MIN}$

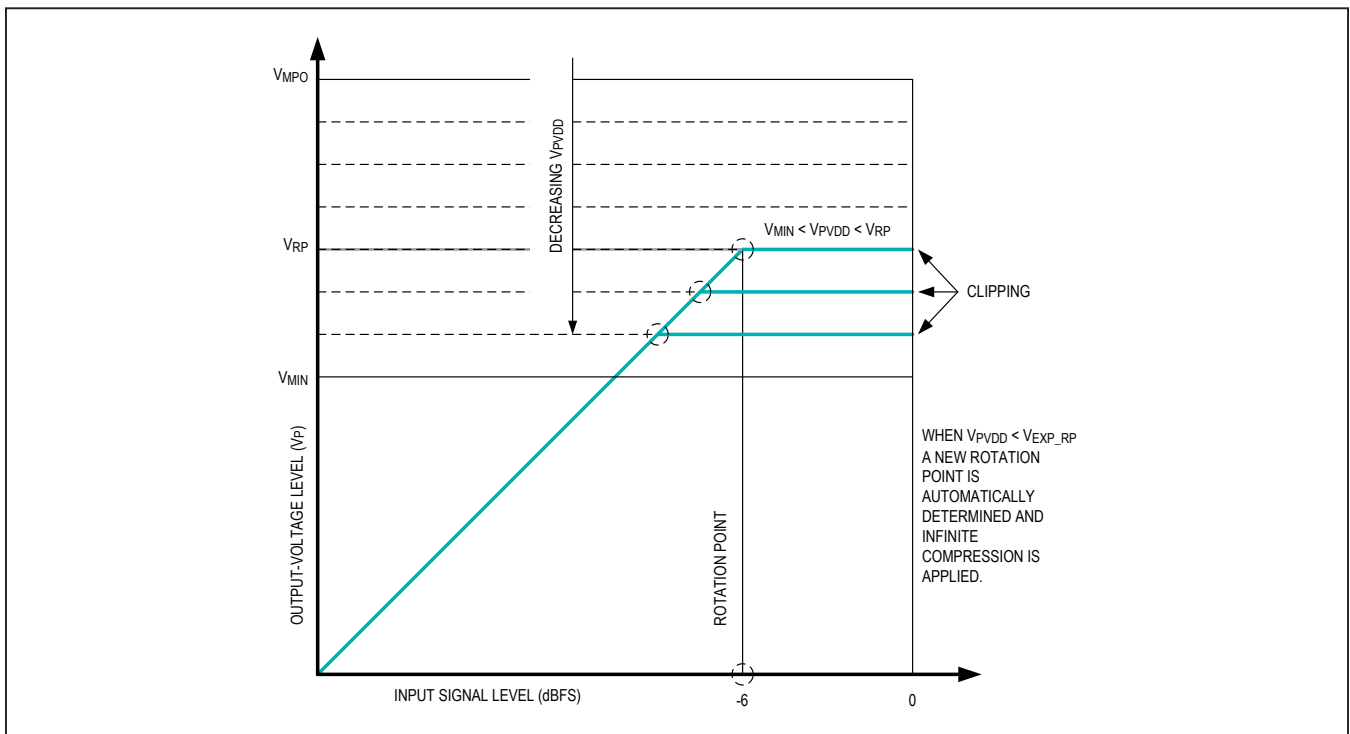

Figure 28. Example of DHT in Mode 3a Operation (Limiter Disabled)

MODE 3b: V_{PVDD} is less than V_{MIN} and greater than V_{RP}

This mode can only occur if the rotation point (V_{RP}) is set lower than V_{MIN} . In this configuration, if V_{PVDD} is less than V_{MIN} , the DHT cannot compress the signal any further. As V_{PVDD} decreases below V_{MIN} , the compression ratio stays fixed and the output signal starts to clip (Figure 29). This clipping can be eliminated if the limiter is enabled in addition to the DHT (Figure 30).

The transfer function shown in Figure 30 is typically preferable to the transfer function shown in Figure 29. When the DHT and the limiter are used together, it allows for the creation of a second inflection point on the transfer function. This second inflection point reduces the transition from compression to limiting and minimizes the audible impact of signal manipulation by the DHT.

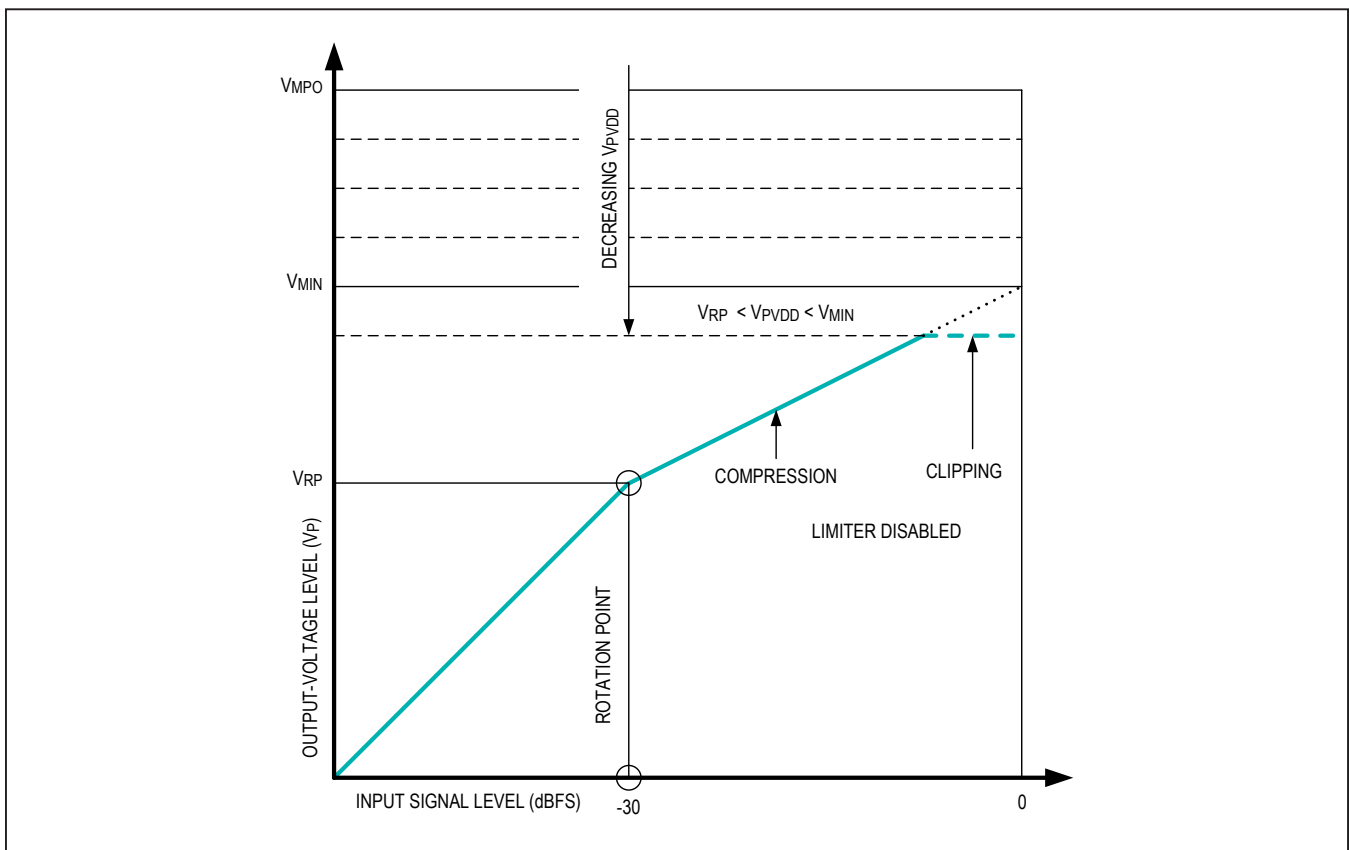

Figure 29. Example of DHT in Mode 3b Operation (Limiter Disabled)

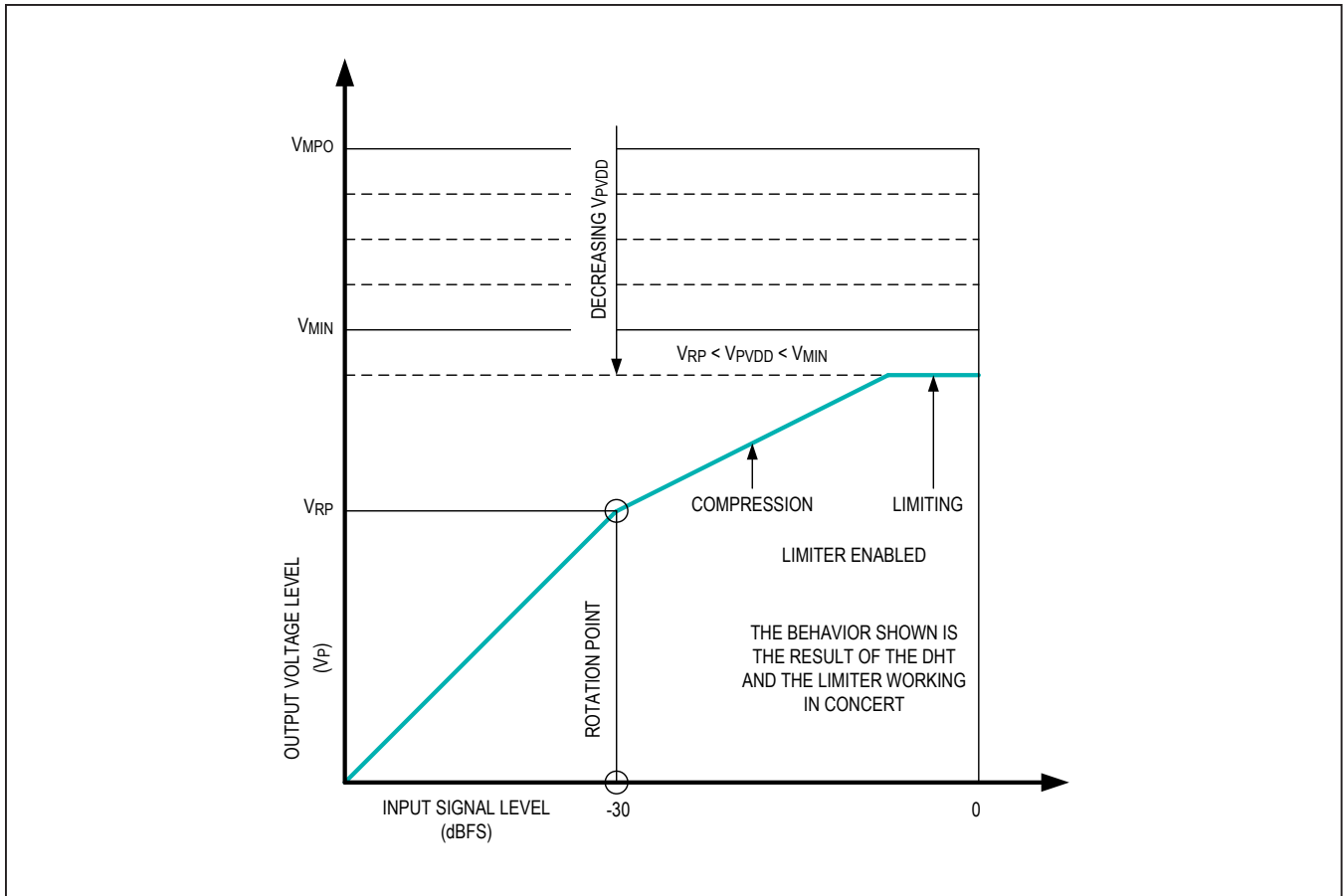

Figure 30. Example of Dynamic Headroom Tracking in Mode 3b Operation (Limiter Enabled)

DHT Enable

REGISTER ADDRESS = 0x20D4					DESCRIPTION
BIT	PoR	BIT NAME	TYPE	RES	
7	0	RESERVED	—	—	Unused Returns 0 if read.
6	0				
5	0				
4	0				
3	0				
2	0				
1	0				
0	0	DHT_EN	RW-S	EN	DHT Enable Control Select whether DHT is enabled or disabled. 0 = DHT is disabled 1 = DHT is enabled

DHT Configuration

REGISTER ADDRESS = 0x20D1					DESCRIPTION
BIT	PoR	BIT NAME	TYPE	RES	
7	0	DHT_SPK_GAIN_MIN[3:0]	RW-S	EN	DHT Speaker Gain Minimum Sets the speaker gain minimum (VMIN). Values in dB are relative to the baseline speaker path DAC full-scale output level of 3.68dBV. 0000: 5.43VP (8dB) 0110: 10.83VP (14dB) 0001: 6.09VP (9dB) 0111: 12.15VP (15dB) 0010: 6.83VP (10dB) 1000: 13.63VP (16dB) 0011: 7.66VP (11dB) 1001: 15.29VP (17dB) 0100: 8.60VP (12dB) 1010 -1111: Reserved 0101: 9.65VP (13dB)
6	0				
5	0				
4	0				
3	0	DHT_VROT_PNT[3:0]	RW-S	EN	DHT Rotation Point Sets the DHT rotation point. 0000: -0.5dBFS 1000: -10dBFS 0001: -1dBFS 1001: -12dBFS 0010: -2dBFS 1010: -15dBFS 0011: -3dBFS 1011: -18dBFS 0100: -4dBFS 1100: -20dBFS 0101: -5dBFS 1101: -22dBFS 0110: -6dBFS 1110: -25dBFS 0111: -8dBFS 1111: -30dBFS
2	0				
1	0				
0	1				

DHT Ballistics

When an input signal exceeds the rotation point (V_{RP}), DHT compression activates and attenuates the signal at the programmed attack rate. The DHT attack rate and step size are both configurable ([DHT Attack Rate Settings](#)).

The instant that a large signal is input to the device, the output tries to reproduce that signal without any attenuation from the DHT. Over the total attack time, the DHT applies compression to ensure that the signal fits within the available PVDD voltage. However, if a large enough input signal is applied suddenly, there can be hard clipping on the output for a short time. However, after the full attack time has completed, there should be no clipping if sufficient headroom is available. In cases with insufficient headroom, after the attack time has completed, clipping can be prevented by using the limiter with the DHT (see the [Limiter](#) section).

Observing the output waveform, the amount of attenuation applied increases up to when V_{IN} (dBFS) = V_{PVDD}

(dBFS). Once V_{IN} (dBFS) is greater than V_{PVDD} (dBFS), the amount of attenuation observed in the output waveform appears to decrease. This is a result of the output clipping against the PVDD voltage level. In this case, DHT still takes the same amount of time to apply the full compression as though it had the headroom to reproduce the signal.

When compression is active and the input signal falls back down below the rotation point (V_{RP}), DHT releases the applied attenuation at the configured release rate. The DHT release rate and release step size are both configurable ([DHT Release Rate Settings](#)).

When a change in PVDD level triggers the compression algorithm in the DHT block, it has a typical delay of 30µs (until attack or release begins); however, the maximum total latency can approach 60µs. This is caused by a combination of the measurement ADC latency, DSP compute time, and clock edge alignment. If a change in audio amplitude is the trigger, the total delay time is approximately 600µs.

DHT Headroom Calculation

To establish where V_{PVDD} is relative to V_{MPO} , use the following equation:

Equation 1:

$$PVDD \text{ (dB)} = 20 \log(V_{PVDD}/V_{MPO})$$

V_{PVDD} is the voltage readback from the measurement ADC PVDD channel, and V_{MPO} is the maximum peak output voltage. For example, if $V_{PVDD} = 13.63V$ and $V_{MPO} = 13.63V$ (default), then $PVDD \text{ (dB)} = 0dB$ (the maximum value for $PVDD \text{ (dB)}$). If solving Equation 1 returns a value greater than $0dB$, then $0dB$ should be used for further calculations. This is important as the DHT only ever applies attenuation and never applies positive gain.

For example, if $V_{PVDD} = 9.65V$ and $V_{MPO} = 13.63V$ (default), then solving Equation 1 yields approximately $-3dB$. This is the V_{PVDD} level relative to V_{MPO} in dB.

To find the expected compressed output voltage, use the following equation:

Equation 2:

$$ATTENUATION \text{ (dB)} = PVDD \text{ (dB)} - INPUT \text{ (dBFS)} \times (PVDD \text{ (dB)}/RP \text{ (dBFS)})$$

When $PVDD \text{ (dB)} = 0$, the $PVDD \text{ (dB)}$ and the fraction term drop out, which gives attenuation equal to zero. This makes sense because when $PVDD \text{ (dB)} = 0$ there is sufficient headroom to playback any signal input into the device and no compression is needed.

As before, assume $PVDD \text{ (dB)} = -3dBFS$. Now, if the rotation point (V_{RP}) is set to $-10dBFS$ and the input signal level is set to $-5dBFS$, equation 2 can be used to find the output signal attenuation:

$$ATTENUATION \text{ (dB)} = PVDD \text{ (dB)} - INPUT \text{ (dBFS)} \times (PVDD \text{ (dB)}/RP \text{ (dBFS)})$$

$$ATTENUATION \text{ (dB)} = -3dB - (-5dBFS \times -3dB/-10dBFS)$$

$$ATTENUATION \text{ (dB)} = -1.5dB$$

For this example, the total amount of compression applied by DHT is $1.5dB$. The output signal level can be found by summing the input signal level to the calculated output attenuation.

$$OUTPUT \text{ (dBFS)} = INPUT \text{ (dBFS)} + ATTENUATION \text{ (dB)} = -6.5dBFS$$

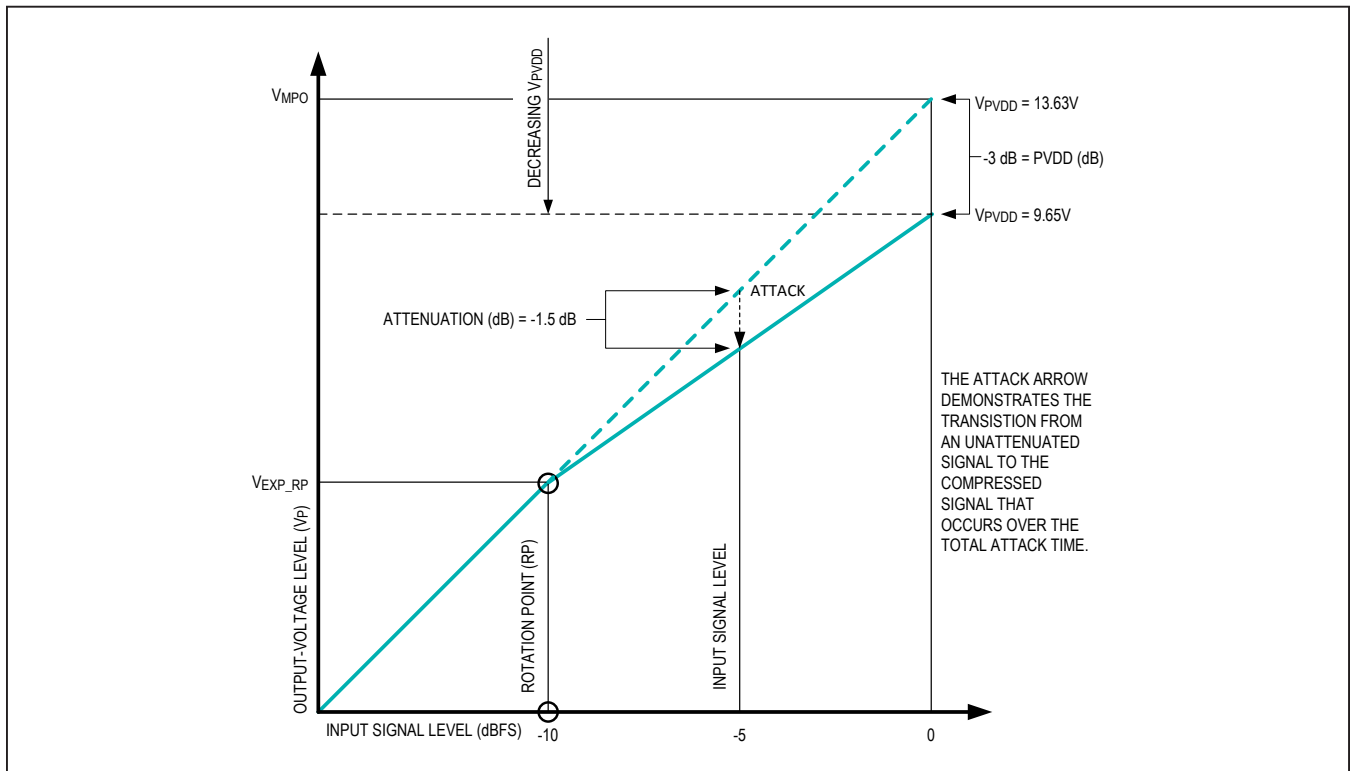

Figure 31. DHT Attack Functionality

DHT Attack Rate Settings

REGISTER ADDRESS = 0x20D2					DESCRIPTION
BIT	PoR	BIT NAME	TYPE	RES	
7	0	RESERVED	—	—	Unused Returns 0 if read.
6	0				
5	0				
4	0	DHT_ATK_STEP[1:0]	RW-S	EN	DHT Attack Step Size Sets the DHT compressor attack step size. 00: 0.25dB 01: 0.5dB 10: 1.0dB 11: 2.0dB
3	0				
2	0	DHT_ATK_RATE[2:0]	RW-S	EN	DHT Attack Rate Sets the DHT compressor attack rate. 000: 17.5µs/step 001: 35µs/step 010: 70µs/step 011: 140µs/step 100: 280µs/step 101: 560µs/step 110: 1120µs/step 111: 2240µs/step
1	1				
0	0				

DHT Release Rate Settings

REGISTER ADDRESS = 0x20D3					DESCRIPTION
BIT	PoR	BIT NAME	TYPE	RES	
7	0	RESERVED	—	—	Unused Returns 0 if read.
6	0				
5	0				
4	0	DHT_RLS_STEP[1:0]	RW-S	EN	DHT Release Step Size Sets the DHT compressor release step size. 00: 0.25dB 01: 0.5dB 10: 1.0dB 11: 2.0dB
3	0				
2	0	DHT_RLS_RATE[2:0]	RW-S	EN	DHT Release Rate Sets the DHT compressor release rate. 000: 45ms/step 001: 225ms/step 010: 450ms/step 011: 1150ms/step 100: 2250ms/step 101: 3100ms/step 110: 4500ms/step 111: 6750ms/step
1	1				
0	1				

Limiter

The device features a programmable limiter that is used to compress large near full-scale signals. The limiter functions both during normal operation (BDE disabled or inactive) and in conjunction with the BDE level configurations.

In normal operation with the BDE controller disabled (BDE_EN = 0, Brownout Detection Engine Enable) or inactive (BDE_EN = 1 and BDE_STATE = 0, Brownout Detection Engine Current State), the limiter is enabled when the LIM_EN bit (*Limiter Enable*) is set to 1. The limiter threshold is manually programmed with the LIM_THRESH bit field, (*Limiter Threshold Configuration*) and can be configured from 0dBFS to -15dBFS in 1 dB steps.

When the BDE is both enabled (BDE_EN = 1) and active (BDE_STATE > 0) the LIM_EN, LIM_THRESH_SEL, and LIM_THRESH settings are ignored. In this state, the limiter threshold is determined solely by the current BDE level. Each BDE level has an individually configured limiter threshold setting (set by BDE_Ln_LIM).

The limiter attack and release rates are programmable using the LIM_ATK_RATE and LIM_RLS_RATE bit fields respectively (*Limiter Attack and Release Rate Configuration*). Attenuation is applied when the output signal is higher than the current limiter threshold, and is released once the output signal returns to a level below that threshold. The configured limiter attack and release rates apply to all limiter operating modes.

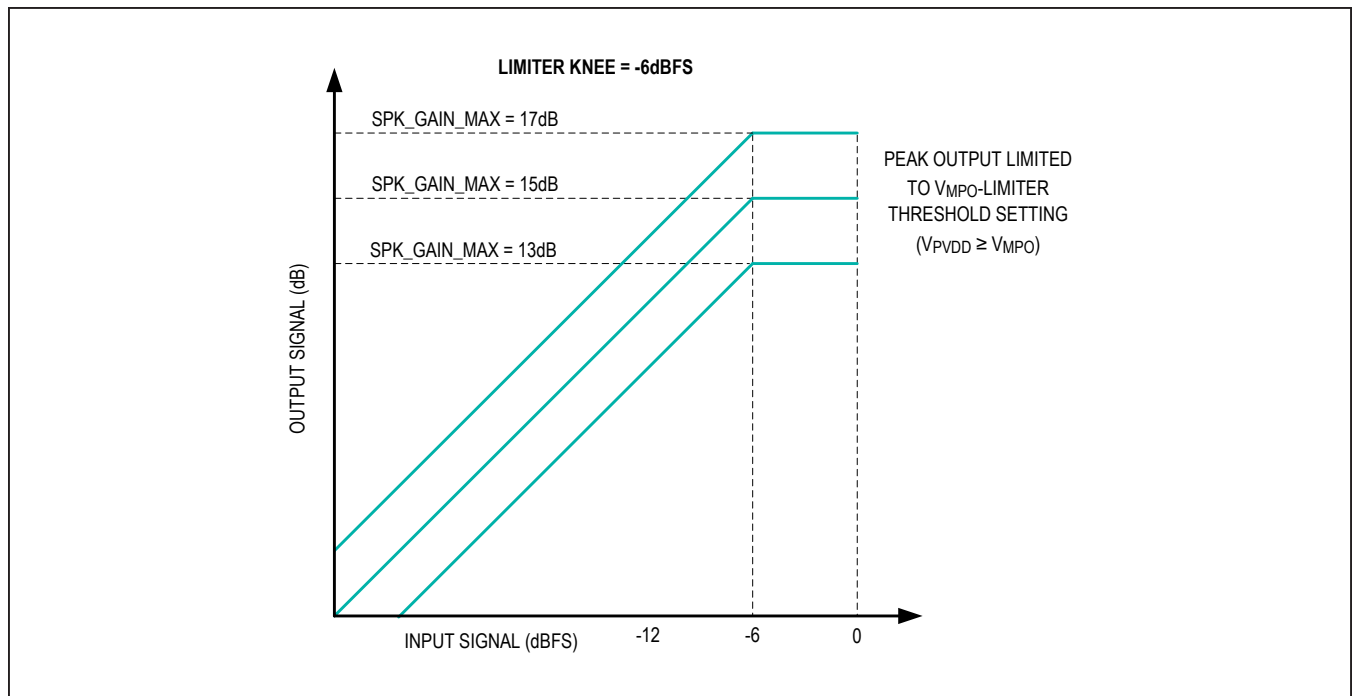

Figure 32. Example of Limiter Operation with the BDE Inactive

Limiter Enable

REGISTER ADDRESS = 0x20E2					DESCRIPTION
BIT	PoR	BIT NAME	TYPE	RES	
7	0	RESERVED	—	—	Unused Returns 0 if read.
6	0				
5	0				
4	0				
3	0				
2	0				
1	0				
0	0	LIM_EN	RW-S	EN	Limiter Enable Control Selects whether or not the limiter is enabled when the BDE is inactive. 0 = Limiter is disabled when the BDE is inactive 1 = Limiter is enabled when the BDE is inactive

Limiter Threshold Configuration

REGISTER ADDRESS = 0x20E0					DESCRIPTION
BIT	PoR	BIT NAME	TYPE	RES	
7	0	RESERVED	—	—	Unused Returns 0 if read.
6	0	LIM_THRESH[4:0]	RW-S	EN	Limiter Threshold Setting Selects the limiter threshold setting (dBFS below V_{MPO}). 00000: 0dBFS 00001: -1dBFS 00010: -2dBFS ... (-1dBFS steps) 01110: -14dBFS 01111: -15dBFS 10000 to 11111: Reserved
5	0				
4	0				
3	0				
2	0				
1	0	RESERVED	—	—	Unused Returns 0 if read.
0	0				
0	0	RESERVED	—	—	Unused Returns 0 if read.

Limiter Attack and Release Rate Configuration

REGISTER ADDRESS = 0x20E1					DESCRIPTION
BIT	PoR	BIT NAME	TYPE	RES	
7	0	LIM_ATK_RATE[3:0]	RW-S	EN	Limiter Attack Rate Selects the attack rate for the limiter. 0000 = 10µs/dB 0001 = 20µs/dB 0010 = 40µs/dB 0011 = 80µs/dB 0100 = 160µs/dB 0101 = 320µs/dB 0110 = 640µs/dB 0111 = 1.28ms/dB 1000 = 2.56ms/dB 1001 = 5.12ms/dB 1010 = 10.24ms/dB 1011 = 20.48ms/dB 1100 = 40.96ms/dB 1101 = 81.92ms/dB 1110 = 163.84ms/dB 1111 = 327.68ms/dB
6	0				
5	0				
4	0				
3	0				
2	0				
1	0				
0	0				

Brownout-Detection Engine (BDE)

The BDE allows the device to reduce its contribution to the overall system power consumption as V_{PVDD} drops. The BDE can be enabled at any time by setting the BDE_EN bit high (*BDE Enable*). However, the BDE must not be disabled when it is active (in critical supply levels 1 through 4). The BDE can be disabled safely at any time that it is inactive (see [Table 17](#)).

The input to the BDE controller comes from the measurement ADC PVDD channel. If the measurement ADC PVDD channel is not already active, enabling the BDE automatically enables it. The sample rate and filter settings for the measurement ADC determine the speed at which the BDE updates.

BDE State Controller and Level Thresholds

There are a total of four BDE critical battery levels each with individually programmable thresholds. The thresholds for each level are configured with the BDE_L1_VTHRESH to BDE_L4_VTHRESH bit fields respectively. The BDE state controller monitors the measurement ADC PVDD channel results and automatically makes state changes.

As the BDE controller progresses to higher BDE levels (e.g., from Level 2 to Level 3), transitions between states happens instantly. However, when the brownout controller progresses back to lower levels (e.g., from Level 2 to Level 1), transition thresholds include programmable hysteresis and are subject to the programmable BDE hold time. The current BDE state can be read-back at any time from the BDE_STATE bit field (*BDE Current State*).

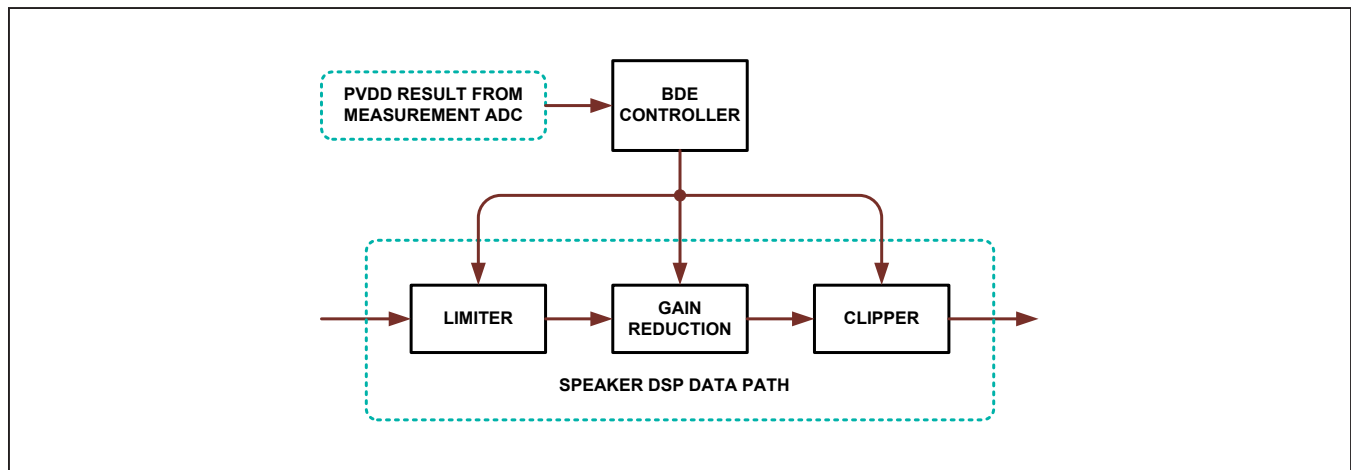

Figure 33. BDE Block Diagram

Table 17. BDE Operating Levels

CURRENT STATE	V_{PVDD} SUPPLY OPERATING RANGE
BDE Inactive (Level 0)	$V_{PVDD} > \text{Critical Battery Level 1}$
Critical Supply Level 1	Critical Battery Level 1 + Hysteresis $\geq V_{PVDD} > \text{Critical Battery Level 2}$
Critical Supply Level 2	Critical Battery Level 2 + Hysteresis $\geq V_{PVDD} > \text{Critical Battery Level 3}$
Critical Supply Level 3	Critical Battery Level 3 + Hysteresis $\geq V_{PVDD} > \text{Critical Battery Level 4}$
Critical Supply Level 4	Critical Battery Level 4 + Hysteresis $\geq V_{PVDD}$

The programmable hold time and threshold hysteresis behaves as follows (consider BDE inactive as level 0):

- In level N, transition to level N+1 when V_{PVDD} falls to less than or equal to the level N+1 threshold.
- In level N, transition to level N-1 when V_{PVDD} rises and remains above the level N threshold + hysteresis for the configured BDE hold time.

The V_{PVDD} hysteresis is programmed with the BDE_VTHRESH_HYST bit field ([BDE Level Threshold Hysteresis](#)) and can be set to be larger than the distance between two levels. Regardless, the BDE state only transitions one level at a time. As a note of caution, it is possible to program the level of hysteresis so that it is not possible to return to the lower BDE levels (even at a normal PVDD voltage level).

The BDE hold time applies to all ascending BDE level transitions and is configured with the BDE_HLD bit field ([BDE Level Hold Time](#)). In addition, BDE Level 4 provides an infinite hold option that is enabled by setting the BDE_L4_INF_HLD bit to 1 ([BDE Level 4 Clipper and State Configuration](#)). When infinite hold is enabled, once level 4 becomes the active state, the BDE controller will not transition to a lower level even if the battery voltage level rises above the level 4 threshold (including hysteresis). While in infinite hold, the BDE controller cannot exit level 4 until the BDE_L4_HLD_RLS bit field ([BDE Level 4 Infinite Hold Clear](#)) is written with a logic high or the I2C registers are reset to their PoR states.

The BDE controller makes states transition as shown in [Figure 34](#).

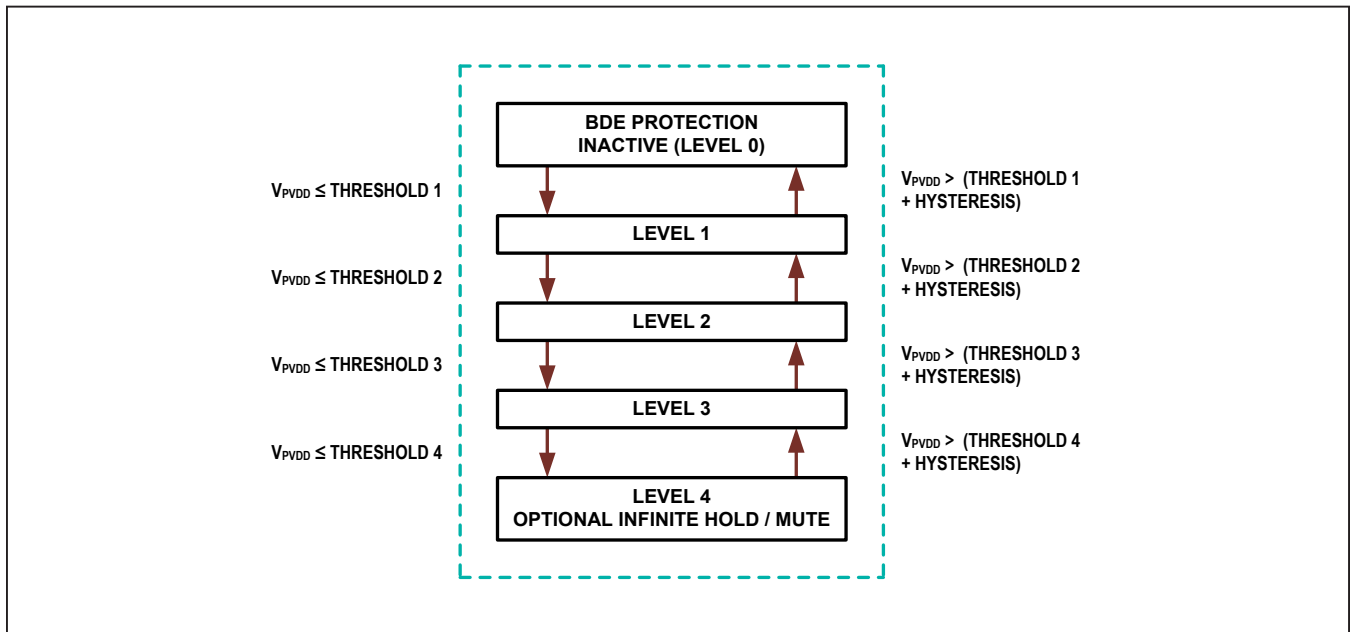

Figure 34. BDE Level State Transitions

BDE Level Configuration Options

For a given BDE level, the following options are configurable to reduce the overall device current draw:

- Programmable Speaker Amplifier Path Gain
- Programmable Speaker Amplifier Signal Limiter Knee
- Programmable Speaker Amplifier Clipping Limit

Each of these configuration options are individually configurable for each BDE level. In addition, level 4 also includes an optional digital mute. The BDE level 4 digital mute is a protection feature, and if enabled, mute engages rapidly (without regard to attack time settings) upon entering level 4. When exiting level 4, the digital mute releases according to the configured gain reduction release rate ([BDE Gain Reduction Attack/Release Rates](#)).

Table 18 is provided as an example case (at the global conditions) as opposed to a definitive use case. The illus-

trative case assumes that the BDE is active, but the DHT block is disabled.

BDE Gain Reduction

The gain reduction block applies smooth digital gain changes to the signal path. The gain reduction is programmable from 0dB to -15dB of attenuation in 0.25dB steps and can be selected individually by BDE level using the BDE_Ln_GAIN bit fields.

The attack rate is programmable to either be instantaneous (no ramp) or over a range from 10µs/dB to 163.84ms/dB using the BDE_GAIN_ATK bit field ([BDE Gain Reduction Attack/Release Rates](#)). The release rate is also programmable over a range from 40µs/dB to 1310.73ms/dB using the BDE_GAIN_RLS bit field ([BDE Gain Reduction Attack/Release Rates](#)). The selected attack and release rate is common to all BDE levels.

Table 18. Example of BDE Settings

LEVEL NUMBER	V _{PVDD} THRESHOLD	LIMITER KNEE	GAIN REDUCTION	CLIPPER LEVEL
BDE Inactive	N/A	0dBFS	0dBFS	0dBFS
BDE Level 1	8.100V	-5dBFS	0dBFS	0dBFS
BDE Level 2	7.200V	-7dBFS	0dBFS	0dBFS
BDE Level 3	6.300V	-9dBFS	-3dBFS	-9dBFS
BDE Level 4	5.475V	N/A	Mute	N/A

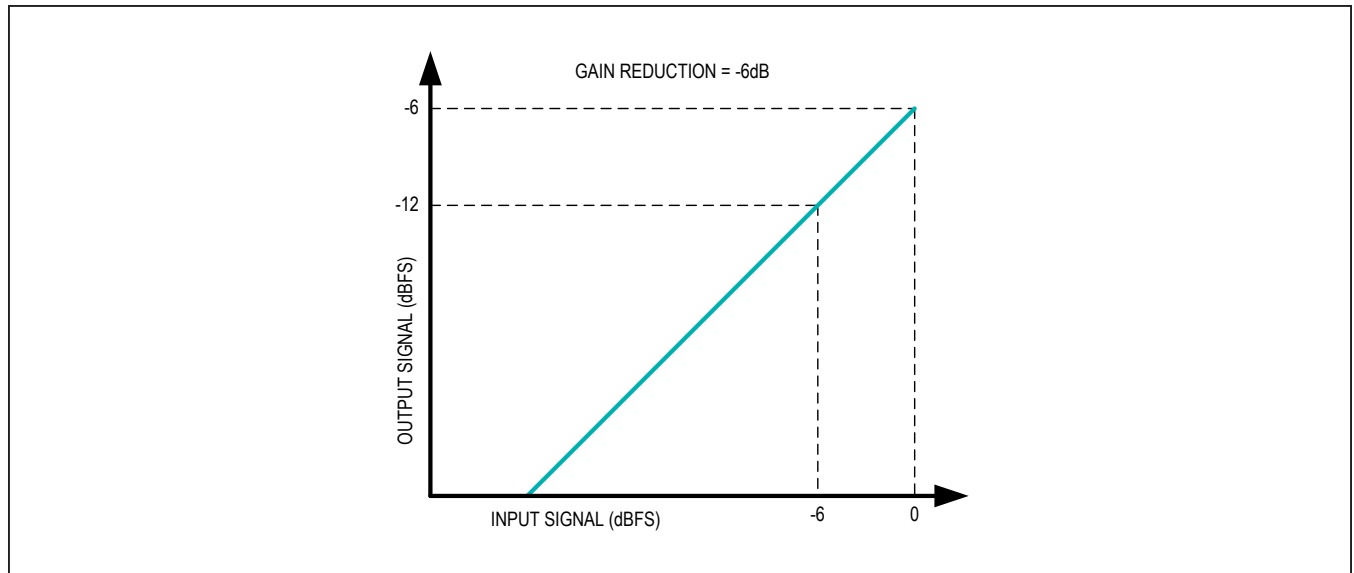

Figure 35. Gain Reduction Profile Example with -6dB Setting

BDE Limiter Function

When the BDE is enabled ($BDE_EN = 1$) and active ($BDE_STATE > 0$), the limiter ignores the LIM_EN and LIM_THRESH settings ([Limiter Enable](#) and [Limiter Threshold Configuration](#)). In this state, the limiter knee threshold is determined solely by the current BDE level. Each BDE level has an individually configured limiter threshold (set by BDE_Ln_LIM) that is programmable from 0dBFS and -15dBFS in 1dB steps.

Input signals that exceed the limiter knee threshold are attenuated, while input signals below the threshold are not. The attack and release rates are programmable, and all BDE levels use the same settings ([Limiter Attack and Release Rate Configuration](#)).

BDE Clipper Function

The BDE clipper limits the maximum digital output codes to a programmable value. The clipper level range is from 0dBFS to -15dBFS in 0.25dB steps and is configured by level using the BDE_Ln_CLIP bit fields. The BDE clipper level threshold is applied based on the current-signal level relative to full scale at the input to the clipper block.

Therefore, signal gain/level adjustments from blocks preceding the clipper block impacts the configured clipper level threshold ([Figure 22](#)).

An example of this is the speaker path maximum peak output-voltage scaling configuration (SPK_GAIN_MAX , [Speaker Path Output Level Scaling](#)). This control uses a combination of digital and analog gain ([Table 16](#)). However, the BDE clipper block is positioned between the digital gain and the analog gain blocks in the signal path. Since the digital gain portion of the selected peak output-voltage setting is located before the clipper block, its setting can impact the clipper threshold level. Therefore, it should be accounted for when choosing the clipper level threshold.

The BDE clipper changes can be configured with the BDE_CLIP_MODE bit ([BDE Clipper Mode](#)) to either be applied to the signal path either immediately or to wait until after a zero cross event. If the signal is DC (or similar) and a zero cross events never occur, then the clipper must be configured to make changes immediately.

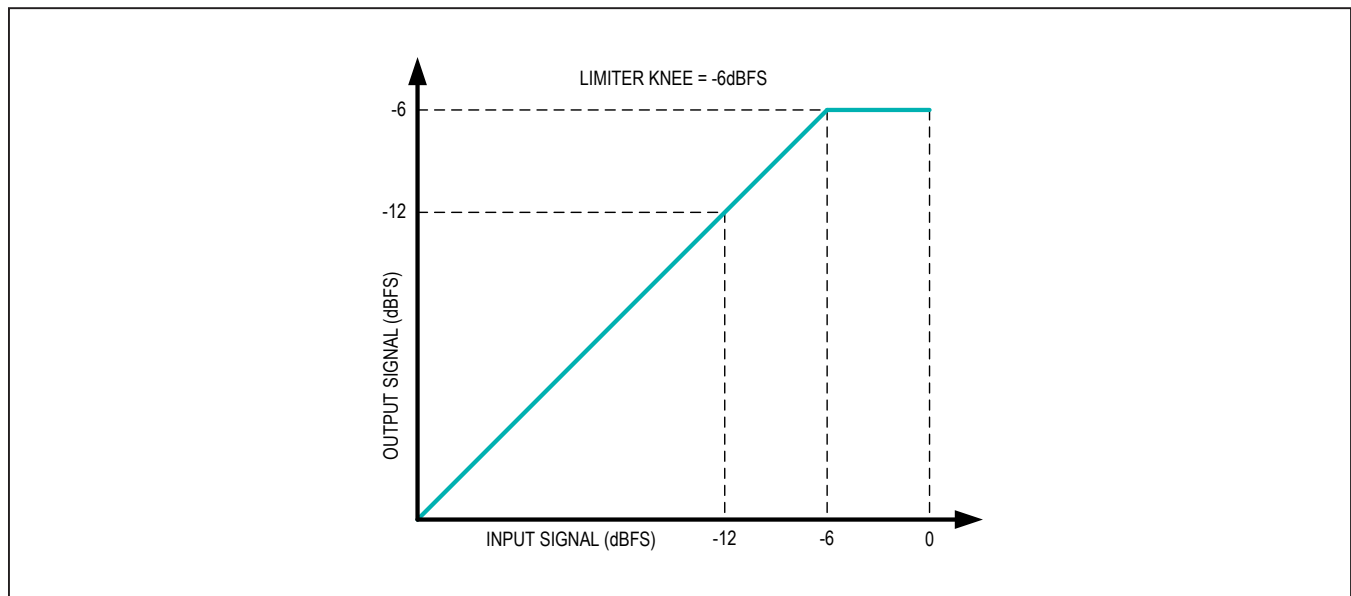

Figure 36. Limiter Profile Example with -6dBFS Knee Level

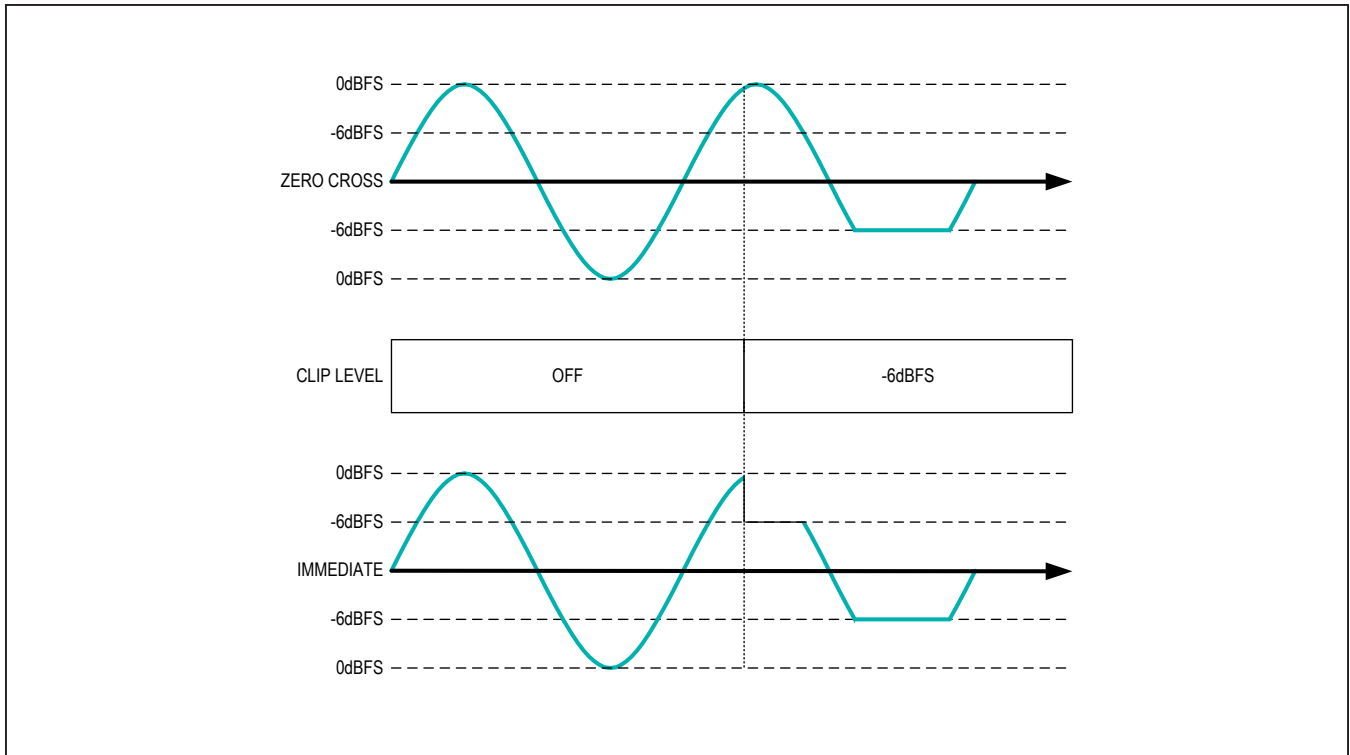

Figure 37. Clipper Example with -6dBFS Threshold

BDE Current State

REGISTER ADDRESS = 0x20B6					DESCRIPTION
BIT	PoR	BIT NAME	TYPE	RES	
7	0	RESERVED	—	—	Unused Returns 0 if read.
6	0				
5	0				
4	0				
3	0	BDE_STATE[3:0]	R	—	BDE Controller Current State Current level of the BDE controller. 0000 = BDE is either disabled or inactive 0001 to 0100 = Reserved 0101 = Level 1 0110 = Level 2 0111 = Level 3 1000 = Level 4 1001 to 1111 = Reserved
2	0				
1	0				
0	0				

BDE Level Hold Time

REGISTER ADDRESS = 0x2090					DESCRIPTION
BIT	PoR	BIT NAME	TYPE	RES	
7	0	BDE_HLD[7:0]	RW-R	BDE	BDE Level Hold Time Sets the hold time for each ascending state in the BDE controller. 0x00 = 0 ms 0x01 = 1 ms 0x02 = 2 ms ... = (1 ms steps) 0xFD = 253 ms 0xFE = 254 ms 0xFF = 255 ms
6	0				
5	0				
4	0				
3	0				
2	0				
1	0				
0	0				

BDE Enable

REGISTER ADDRESS = 0x20B5					DESCRIPTION
BIT	PoR	BIT NAME	TYPE	RES	
7	0	RESERVED	—	—	Unused Returns 0 if read.
6	0				
5	0				
4	0				
3	0				
2	0				
1	0				
0	0	BDE_EN	RW-D	—	BDE Controller Enable Enables and disables the BDE controller. Do not disable the BDE controller when it is actively protecting the system (in levels 1 to 4). 0 = BDE controller disabled 1 = BDE controller enabled

BDE Level 1 Threshold

REGISTER ADDRESS = 0x2097					DESCRIPTION
BIT	PoR	BIT NAME	TYPE	RES	
7	0	BDE_L1_VTHRESH[7:0]	RW-R	BDE	BDE Level 1 Threshold Setting Sets the VPVDD threshold for BDE Level 1. The threshold voltage is calculated with the following formula: $V_{PVDD} \text{ Threshold} = (\text{BDE_L1_VTHRESH}[7:0] - 32) \times 0.075V$ A value of 0x00 (all zeros) means this level is not used and is entirely bypassed (no hold times).
6	0				
5	0				
4	0				
3	0				
2	0				
1	0				
0	0				

BDE Level 2 Threshold

REGISTER ADDRESS = 0x2098					DESCRIPTION
BIT	PoR	BIT NAME	TYPE	RES	
7	0	BDE_L2_VTHRESH[7:0]	RW-R	BDE	<p>BDE Level 2 Threshold Setting</p> <p>Sets the V_{PVDD} threshold for BDE Level 2. The threshold voltage is calculated with the following formula:</p> $V_{PVDD} \text{ threshold} = (\text{BDE_L2_VTHRESH}[7:0] - 32) \times 0.075V$ <p>A value of 0x00 (all zeros) means this level is not used and is entirely bypassed (no hold times).</p>
6	0				
5	0				
4	0				
3	0				
2	0				
1	0				
0	0				

BDE Level 3 Threshold

REGISTER ADDRESS = 0x2099					DESCRIPTION
BIT	PoR	BIT NAME	TYPE	RES	
7	0	BDE_L3_VTHRESH[7:0]	RW-R	BDE	<p>BDE Level 3 Threshold Setting</p> <p>Sets the V_{PVDD} threshold for BDE Level 3. The threshold voltage is calculated with the following formula:</p> $V_{PVDD} \text{ threshold} = (\text{BDE_L3_VTHRESH}[7:0] - 32) \times 0.075V$ <p>A value of 0x00 (all zeros) means this level is not used and is entirely bypassed (no hold times).</p>
6	0				
5	0				
4	0				
3	0				
2	0				
1	0				
0	0				

BDE Level 4 Threshold

REGISTER ADDRESS = 0x209A					DESCRIPTION
BIT	PoR	BIT NAME	TYPE	RES	
7	0	BDE_L4_VTHRESH[7:0]	RW-R	BDE	<p>BDE Level 4 Threshold Setting</p> <p>Sets the V_{PVDD} threshold for BDE level 4. The threshold voltage is calculated with the following formula:</p> $V_{PVDD} \text{ threshold} = (\text{BDE_L4_VTHRESH}[7:0] - 32) \times 0.075V$ <p>A value of 0x00 (all zeros) means this level is not used and is entirely bypassed (no hold times).</p>
6	0				
5	0				
4	0				
3	0				
2	0				
1	0				
0	0				

BDE Level Threshold Hysteresis

REGISTER ADDRESS = 0x209B					DESCRIPTION
BIT	PoR	BIT NAME	TYPE	RES	
7	0	BDE_VTHRESH_HYST[7:0]	RW-R	BDE	<p>BDE Threshold Hysteresis</p> <p>Sets the BDE level threshold hysteresis for increasing V_{PVDD}.</p> <p>00000000 = No hysteresis 00000001 = 1 LSB of hysteresis 00000010 = 2 LSBs of hysteresis ... = (1 LSB steps) 11111110 = 254 LSBs of hysteresis 11111111 = 255 LSBs of hysteresis</p>
6	0				
5	0				
4	0				
3	0				
2	0				
1	0				
0	0				

BDE Gain Reduction Attack/Release Rates

REGISTER ADDRESS = 0x2091					DESCRIPTION	
BIT	PoR	BIT NAME	TYPE	RES		
7	0	BDE_GAIN_ATK[3:0]	RW-R	SFB	BDE Gain Reduction Attack Rate Control Selects the attack rate for BDE gain reduction. 0000 = Instantaneous (step change, no ramp) 0001 = 10µs/dB 0010 = 20µs/dB 0011 = 40µs/dB 0100 = 80µs/dB 0101 = 160µs/dB 0110 = 320µs/dB 0111 = 640µs/dB 1000 = 1.28ms/dB 1001 = 2.56ms/dB 1010 = 5.12ms/dB 1011 = 10.24ms/dB 1100 = 20.48ms/dB 1101 = 40.96ms/dB 1110 = 81.92ms/dB 1111 = 163.84ms/dB	
6	0					
5	0					
4	0					
3	0	BDE_GAIN_RLS[3:0]	RW-R	SFB		BDE Gain Reduction Release Rate Control Selects the release rate for BDE gain reduction. 0000 = 40µs/dB 0001 = 80µs/dB 0010 = 160µs/dB 0011 = 320µs/dB 0100 = 640µs/dB 0101 = 1.28ms/dB 0110 = 2.56ms/dB 0111 = 5.12ms/dB 1000 = 10.24ms/dB 1001 = 20.48ms/dB 1010 = 40.96ms/dB 1011 = 81.92ms/dB 1100 = 163.84ms/dB 1101 = 327.68ms/dB 1110 = 655.36ms/dB 1111 = 1310.72ms/dB
2	0					
1	0					
0	0					

BDE Clipper Mode

REGISTER ADDRESS = 0x2092					DESCRIPTION
BIT	PoR	BIT NAME	TYPE	RES	
7	0	RESERVED	—	—	Unused Returns 0 if read.
6	0				
5	0				
4	0				
3	0				
2	0				
1	0				
0	0	BDE_CLIP_MODE	RW-R	SFB	BDE Clipper Level Change Mode Controls when the BDE clipper level changes are applied. 0 = Clip level changes occur on zero cross event 1 = Clip level changes occur as soon as possible

BDE Level 1 Limiter Configuration

REGISTER ADDRESS = 0x20A8					DESCRIPTION
BIT	PoR	BIT NAME	TYPE	RES	
7	0	RESERVED	—	—	Unused Returns 0 if read.
6	0				
5	0				
4	0				
3	0	BDE_L1_LIM[3:0]	RW-R	BDE	BDE Level 1 Limiter Threshold Sets the BDE limiter threshold for Level 1. 0 = 0dBFS 1 = -1dBFS 2 = -2dBFS = (-1dBFS steps) 14 = -14dBFS 15 = -15dBFS
2	0				
1	0				
0	0				

BDE Level 1 Clipper Configuration

REGISTER ADDRESS = 0x20A9					DESCRIPTION
BIT	PoR	BIT NAME	TYPE	RES	
7	0	RESERVED	—	—	Unused Returns 0 if read.
6	0				
5	0	BDE_L1_CLIP[5:0]	RW-R	BDE	BDE Level 1 Clipper Threshold Sets the threshold at which clipping occurs in BDE level 1. 000000 = 0dBFS 000001 = -0.25dBFS 000010 = -0.50dBFS 000011 = -0.75dBFS = (-0.25dBFS steps) 111010 = -14.50dBFS 111011 = -14.75dBFS 111100 = -15.00dBFS 111101-111111 = Reserved
4	0				
3	0				
2	0				
1	0				
0	0				

BDE Level 1 Gain Reduction Configuration

REGISTER ADDRESS = 0x20AA					DESCRIPTION
BIT	PoR	BIT NAME	TYPE	RES	
7	0	RESERVED	—	—	Unused Returns 0 if read.
6	0				
5	0	BDE_L1_GAIN[5:0]	RW-R	BDE	BDE Level 1 Gain Reduction Sets the gain reduction for BDE level 1. 000000 = 0dB 000001 = -0.25dB 000010 = -0.50dB 000011 = -0.75dB = in -0.25dB steps 111010 = -14.50dB 111011 = -14.75dB 111100 = -15.00dB 111101-111111 = Reserved
4	0				
3	0				
2	0				
1	0				
0	0				

BDE Level 2 Limiter Configuration

REGISTER ADDRESS = 0x20AB					DESCRIPTION
BIT	PoR	BIT NAME	TYPE	RES	
7	0	RESERVED	—	—	Unused Returns 0 if read.
6	0				
5	0				
4	0				
3	0	BDE_L2_LIM[3:0]	RW-R	BDE	BDE Level 2 Limiter Threshold Sets the BDE limiter threshold for Level 2. 0 = 0dBFS 1 = -1dBFS 2 = -2dBFS = (-1dBFS steps) 14 = -14dBFS 15 = -15dBFS
2	0				
1	0				
0	0				

BDE Level 2 Clipper Configuration

REGISTER ADDRESS = 0x20AC					DESCRIPTION
BIT	PoR	BIT NAME	TYPE	RES	
7	0	RESERVED	—	—	Unused Returns 0 if read.
6	0				
5	0	BDE_L2_CLIP[5:0]	RW-R	BDE	BDE Level 2 Clipper Threshold Sets the threshold at which clipping occurs in BDE level 2. 000000 = 0dBFS 000001 = -0.25dBFS 000010 = -0.50dBFS 000011 = -0.75dBFS = (-0.25dBFS steps) 111010 = -14.50dBFS 111011 = -14.75dBFS 111100 = -15.00dBFS 111101-111111 = Reserved
4	0				
3	0				
2	0				
1	0				
0	0				

BDE Level 2 Gain Reduction Configuration

REGISTER ADDRESS = 0x20AD					DESCRIPTION
BIT	PoR	BIT NAME	TYPE	RES	
7	0	RESERVED	—	—	Unused Returns 0 if read.
6	0				
5	0	BDE_L2_GAIN[5:0]	RW-R	BDE	BDE Level 2 Gain Reduction Sets the gain reduction for BDE level 2. 000000 = 0dB 000001 = -0.25dB 000010 = -0.50dB 000011 = -0.75dB = in -0.25dB steps 111010 = -14.50dB 111011 = -14.75dB 111100 = -15.00dB 111101-111111 = Reserved
4	0				
3	0				
2	0				
1	0				
0	0				

BDE Level 3 Limiter Configuration

REGISTER ADDRESS = 0x20AE					DESCRIPTION
BIT	PoR	BIT NAME	TYPE	RES	
7	0	RESERVED	—	—	Unused Returns 0 if read.
6	0				
5	0				
4	0				
3	0	BDE_L3_LIM[3:0]	RW-R	BDE	BDE Level 3 Limiter Threshold Sets the BDE limiter threshold for level 3. 0 = 0dBFS 1 = -1dBFS 2 = -2dBFS = in -1dBFS steps 14 = -14dBFS 15 = -15dBFS
2	0				
1	0				
0	0				

BDE Level 3 Clipper Configuration

REGISTER ADDRESS = 0x20AF					DESCRIPTION
BIT	PoR	BIT NAME	TYPE	RES	
7	0	RESERVED	—	—	Unused Returns 0 if read.
6	0				
5	0	BDE_L3_CLIP[5:0]	RW-R	BDE	BDE Level 3 Clipper Threshold Sets the threshold at which clipping occurs in BDE level 3. 000000 = 0dBFS 000001 = -0.25dBFS 000010 = -0.50dBFS 000011 = -0.75dBFS = (-0.25dBFS steps) 111010 = -14.50dBFS 111011 = -14.75dBFS 111100 = -15.00dBFS 111101-111111 = Reserved
4	0				
3	0				
2	0				
1	0				
0	0				

BDE Level 3 Gain Reduction Configuration

REGISTER ADDRESS = 0x20B0					DESCRIPTION
BIT	PoR	BIT NAME	TYPE	RES	
7	0	RESERVED	—	—	Unused Returns 0 if read.
6	0				
5	0	BDE_L3_GAIN[5:0]	RW-R	BDE	BDE Level 3 Gain Reduction Sets the gain reduction for BDE level 3. 000000 = 0dB 000001 = -0.25dB 000010 = -0.50dB 000011 = -0.75dB = in -0.25dB steps 111010 = -14.50dB 111011 = -14.75dB 111100 = -15.00dB 111101-111111 = Reserved
4	0				
3	0				
2	0				
1	0				
0	0				

BDE Level 4 Limiter Configuration

REGISTER ADDRESS = 0x20B1					DESCRIPTION
BIT	PoR	BIT NAME	TYPE	RES	
7	0	RESERVED	—	—	Unused Returns 0 if read.
6	0				
5	0				
4	0				
3	0	BDE_L4_LIM[3:0]	RW-R	BDE	BDE Level 4 Limiter Threshold Sets the BDE limiter threshold for level 4. 0 = 0dBFS 1 = -1dBFS 2 = -2dBFS = in -1dBFS steps 14 = -14dBFS 15 = -15dBFS
2	0				
1	0				
0	0				

BDE Level 4 Clipper and State Configuration

REGISTER ADDRESS = 0x20B2					DESCRIPTION
BIT	PoR	BIT NAME	TYPE	RES	
7	0	BDE_L4_MUTE	RW-R	BDE	BDE Level 4 Mute Enable Mutes the audio stream when in BDE level 4. 0 = Not muted in BDE level 4 1 = Muted in BDE level 4
6	0	BDE_L4_INF_HLD	RW-R	BDE	BDE Controller Level 4 Infinite Hold Enable Enables the BDE level 4 infinite hold feature. 0 = Transition from level 4 automatically based on PVDD level 1 = Transition from level 4 only after writing to BDE_L4_HLD_RLS
5	0	BDE_L4_CLIP[5:0]	RW-R	BDE	BDE Level 4 Clipper Threshold Sets the threshold at which clipping occurs in BDE level 4. 000000 = 0dBFS 000001 = -0.25dBFS 000010 = -0.50dBFS 000011 = -0.75dBFS = (-0.25dBFS steps) 111010 = -14.50dBFS 111011 = -14.75dBFS 111100 = -15.00dBFS 111101-111111 = Reserved
4	0				
3	0				
2	0				
1	0				
0	0				

BDE Level 4 Gain Reduction Configuration

REGISTER ADDRESS = 0x20B3					DESCRIPTION
BIT	PoR	BIT NAME	TYPE	RES	
7	0	RESERVED	—	—	Unused Returns 0 if read.
6	0				
5	0	BDE_L4_GAIN[5:0]	RW-R	BDE	BDE Level 4 Gain Reduction Sets the gain reduction for BDE level 4. 000000 = 0dB 000001 = -0.25dB 000010 = -0.50dB 000011 = -0.75dB = in -0.25dB steps 111010 = -14.50dB 111011 = -14.75dB 111100 = -15.00dB 111101-111111 = Reserved
4	0				
3	0				
2	0				
1	0				
0	0				

BDE Level 4 Infinite Hold Clear

REGISTER ADDRESS = 0x20B4					DESCRIPTION
BIT	PoR	BIT NAME	TYPE	RES	
7	0	BDE_L4_HLD_RLS	W-D	—	BDE Controller Level 4 Infinite Hold Release Manually releases the BDE controller from level 4 when infinite hold is enabled. 0 = Writing zero has no effect 1 = Release brownout controller from level 4
6	0	RESERVED	—	—	Unused Returns 0 if read.
5	0				
4	0				
3	0				
2	0				
1	0				
0	0				

Thermal Protection

When the device is active, the measurement ADC thermal channel is automatically enabled and continuously monitors die temperature to ensure that it does not exceed the configured thermal thresholds. Interrupt registers are provided so that the device can notify the host when the die temperature crosses the thermal-warning threshold, the thermal-shutdown threshold, or when thermal foldback starts and stops.

Thermal Warning and Shutdown Threshold Configuration

The thermal-warning threshold is configured by the THERMWARN_THRESH[5:0] bit field ([Thermal-Warning Threshold Configuration](#)) and the thermal-shutdown threshold is configured by the THERMSHDN_THRESH[5:0] bit field ([Thermal-Shutdown Threshold Configuration](#)). When the die temperature is decreasing, hysteresis is applied to both thresholds. The temperature hysteresis is configured with the THERM_HYST bit field ([Thermal Hysteresis Configuration](#)). The thermal-warning threshold temperature should never be configured higher than the thermal-shutdown threshold temperature minus hysteresis.

Thermal-Warning Threshold Configuration

REGISTER ADDRESS = 0x2014					DESCRIPTION
BIT	PoR	BIT NAME	TYPE	RES	
7	0	RESERVED	—	—	Unused Returns 0 if read.
6	0				
5	0	THERMWARN_THRESH[5:0]	RW-S	EN	Thermal-Warning Threshold Sets the thermal-warning threshold temperature. 0x00 to 0x05 = Reserved 0x06 = 107.96°C 0x07 = 109.24°C 0x08 = 110.52°C ... = (1.28°C steps) 0x25 = 147.64°C 0x26 = 148.92°C 0x27 to 0x3F = 150.2°C
4	1				
3	0				
2	0				
1	0				
0	0				

Thermal-Shutdown Threshold Configuration

REGISTER ADDRESS = 0x2015					DESCRIPTION
BIT	PoR	BIT NAME	TYPE	RES	
7	0	RESERVED	—	—	Unused Returns 0 if read.
6	0				
5	1	THERMSHDN_THRESH[5:0]	RW-S	EN	Thermal-Shutdown Threshold Sets the thermal-shutdown threshold temperature. 0x00 to 0x05 = Reserved 0x06 = 107.96°C 0x07 = 109.24°C 0x08 = 110.52°C ... = (1.28°C steps) 0x25 = 147.64°C 0x26 = 148.92°C 0x27 to 0x3F = 150.2°C
4	0				
3	0				
2	1				
1	1				
0	1				

Thermal Hysteresis Configuration

REGISTER ADDRESS = 0x2016					DESCRIPTION
BIT	PoR	BIT NAME	TYPE	RES	
7	0	RESERVED	—	—	Unused Returns 0 if read.
6	0				
5	0				
4	0				
3	0				
2	0				
1	0	THERM_HYST[4:0]	RW-S	EN	Thermal Threshold Hysteresis Controls the amount of hysteresis applied to the thermal-threshold measurements. 00 = 2.56°C 01 = 3.84°C 10 = 5.12°C 11 = 6.40°C
0	0				

Thermal Shutdown Recovery Configuration

The device thermal shutdown recovery behavior is determined by the state of the THERM_AUTORESTART_EN bit ([Device Auto-Restart Configuration](#)). When the THERM_AUTORESTART_EN bit is set to 0, the thermal shutdown recovery is in manual mode. In manual mode, when the die temperature exceeds the thermal-shutdown threshold, an interrupt is generated and the amplifier output is automatically disabled. Once the die temperature drops below the thermal shutdown and warning thresholds, the appropriate interrupts are generated to notify the host. In addition, once the die temperature drops below the thermal warning threshold, the device is placed into software shutdown (EN is set to 0) and remains in that state until the host manually re-enables the device.

When the THERM_AUTORESTART_EN bit is set to 1, the thermal shutdown recovery is in automatic mode. In automatic mode, when the die temperature exceeds the thermal-shutdown threshold, an interrupt is generated and the amplifier is automatically disabled. Once the die temperature drops below the thermal-shutdown threshold, an interrupt is generated but the amplifier remains disabled. When the temperature drops below the thermal-warning threshold, another interrupt is generated and (unlike manual mode) the amplifier is then automatically re-enabled.

Thermal Foldback Configuration

The device features thermal foldback to allow for a smoother audio response to high temperature events. Thermal foldback is enabled by setting the THERMFB_EN bit to 1 ([Thermal-Foldback Enable](#)). Once enabled, when the die temperature exceeds the configured thermal-warning threshold (+120°C by default, [Thermal-Warning Threshold Configuration](#)), an interrupt is generated and attenuation is applied to the speaker amplifier path. As the die temperature increases, the level of attenuation also increases proportionally up to a maximum level of -12dB (unless the thermal-shutdown threshold is exceeded first). Likewise, as die temperature decreases (including hysteresis and hold time), the applied attenuation also proportionally decreases. The slope of the thermal-foldback attenuation is programmed with the THERMFB_SLOPE bit field ([Thermal-Foldback Settings](#)).

When thermal foldback is active, the attenuation attack rate (for increasing temperature) is fixed at 10µs/dB. However, the attenuation release rate (for decreasing temperature) is programmable and is configured with the THERMFB_RLS bit field ([Thermal-Foldback Settings](#)). For thermal foldback to end, the die temperature must drop below the thermal-warning threshold (including the programmed hysteresis) and remain there for longer than the configured hold time (set with the THERMFB_HOLD bit field, [Thermal-Foldback Settings](#)). When this occurs, an interrupt is generated and the attenuation completely releases at the programmed release rate.

Thermal-Foldback Settings

REGISTER ADDRESS = 0x2017					DESCRIPTION
BIT	PoR	BIT NAME	TYPE	RES	
7	1	THERMFB_HOLD[1:0]	RW-S	EN	Thermal-Foldback Hold Time The thermal-foldback hold time controls how long the device temperature must remain below the configured thermal-threshold hysteresis before thermal-foldback release begins. 00: 0ms 01: 20ms 10: 40ms 11: 80ms (default)
6	1				
5	0	RESERVED	—	—	Unused Returns 0 if read.
4	0				
3	0	THERMFB_RLS[1:0]	RW-S	EN	Thermal-Foldback Release Rate This sets the release rate of the thermal-foldback attenuation. 00: 3ms/dB 01: 10ms/dB 10: 100ms/dB 11: 300ms/dB
2	0				
1	0	THERMFB_SLOPE[1:0]	RW-S	EN	Thermal-Foldback Attenuation Slope This sets the slope of the thermal-foldback attenuation. 00: 0.5dB/°C 01: 1.0dB/°C 10: 2.0dB/°C 11: Reserved
0	0				

Thermal-Foldback Enable

REGISTER ADDRESS = 0x2018					DESCRIPTION
BIT	PoR	BIT NAME	TYPE	RES	
7	0	RESERVED	—	—	Unused Returns 0 if read.
6	0				
5	0				
4	0				
3	0				
2	0				
1	0				
7	0	THERMFB_EN	RW-S	EN	Thermal-Foldback Enable Enables thermal foldback. 0: Thermal foldback disabled 1: Thermal foldback enabled

ICC Interface

The ICC interface enables multiple MAX98374 devices to be grouped to synchronize device changes from the BDE, limiter, thermal foldback, and DHT blocks. In each group, a single device takes on the role of synchronization master and establishes and aligns the data transfer. Each device in each group transmits one or more channels of data. Each device receives the data of the other grouped devices and reacts accordingly. ICC only operates in I²C control mode, and grouped devices communicate over a single wire ICC bus connected to the bidirectional ICC pin on each device.

ICC Interface Data Format

ICC device data is 16 bits in length, and contains both a 4 bit data tag and a 12 bit payload. The data tag is located in the first 4 bits of the data, and decodes to a unique value that indicates the type of data currently being transmitted. Table 19 shows the tag decode values for each data source. Data tag values from 0x0 to 0x3 correspond to the four device data types while all other data tag values are reserved. The data payload is located in the next 12 bits, and contains the current device data for the transmitted data type. Trailing padding bits are inserted if the configured channel length exceeds 16 bits.

ICC Interface Device Group Assignment

The ICC interface allows for devices to be grouped so that adjustments are synchronized. The receive channel enables (ICC_RX_CHn_EN, [ICC Receiver Enables 1](#)

and [ICC Receiver Enables 2](#)) are used to define groups, and devices receive data from all selected channels. The configured set of receive channels must also include the transmit channel of a given device. Each device in a given group must have identical settings for all ICC receive channel enables. The minimum group size is two devices, however a single group can contain up to four devices.

The ICC transmit channel enable bit (ICC_TX_CH_EN, [ICC Transmitter Enable](#)) enables the device to output data to an assigned ICC channel. The ICC transmit channel destination bit field (ICC_TX_DEST[3:0], [ICC Transmitter Configuration](#)) selects the data channel used for ICC data transmission. For each device, the ICC transmit channel Hi-Z controls (ICC_TX_CHn_HIZ, [ICC Transmitter Channel Configuration 1](#), and [ICC Transmitter Channel Configuration 2](#)) should be configured to enable data transmission on the selected destination channel.

ICC Data Transmit and Receive

The ICC pin is externally connected to the ICC pins of all other grouped MAX98374 devices to form the ICC bus. Each device uses the ICC bus to provide data feedback to the other grouped devices. The ICC bus operates with the same clock source and data format as the current PCM interface configuration and each grouped device sends a single channel of 16-bit ICC data per frame ([Figure 39](#)). Multiple independent groups can share a single ICC bus as long as enough channels are available and no channel assignments overlap across groups.

Table 19. ICC Tag Decode Values

TAG VALUE	DATA TAG DECODE
0x0	Thermal Foldback Data
0x1	BDE Data
0x2	Limiter Attenuation Data
0x3	DHT Data
0x4 to 0xF	Reserved

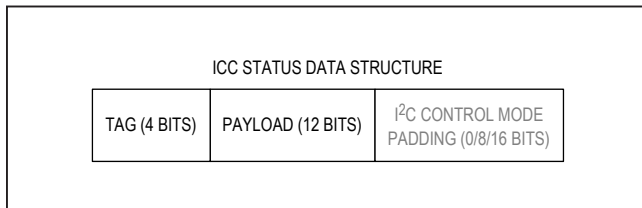

Figure 38. ICC Data Structure

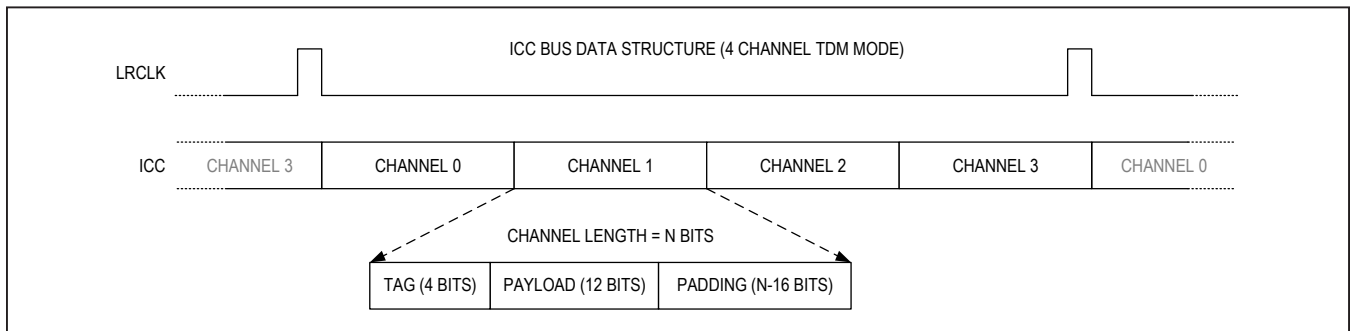

Figure 39. ICC Bus Data Structure

Zero padding bits occupy any extra channel BCLK cycles if the selected channel length is larger than the 16 bits required for the ICC bus data structure (Figure 39).

Device data is transmitted on the ICC bus in a round-robin sequence. Each sequence starts with a data tag of 0 on the first frame, and data is transmitted to each frame in the order of ascending numerical tag values. When the last frame in the sequence is complete (data tag of 3), the next frame restarts the sequence (data tag of 0). Each sequence always contains a frame for each data tag (4 frames per sequence), even if the ICC link for any given data tag is not enabled. Each frame contains one channel of data (for the current data tag) for each device in a given group. Figure 40 illustrates the ICC bus round-robin data sequence.

ICC Interface Group Data Synchronization

At the end of each frame, each device makes the adjustments for each data type that corresponds to either the highest or lowest value reported by all devices within the assigned group. The configuration register bit fields (ICC_x_CONFIG, ICC Data Link Configuration) are used to select whether the highest and lowest value for each data type is used. The configuration settings must match across all devices within an assigned group. This ensures that the adjustments applied by the devices in an assigned group are identical.

Once all grouped devices have reported their data, the selected value for that data type is applied to all devices in

the group. For all data types (except BDE data) there is a delay of two frames until a change is made to the devices in a given group.

For BDE data, a given device immediately uses its own state if it would move the device to a higher BDE level. The BDE data is still transmitted during the appropriate frame, and can then be applied to the other devices in the assigned group.

The delay for ICC data propagating through a configured group is six frames. This is comprised of up to four frames for the data tag to come up in the round-robin rotation, plus the two frame delay for a change to be made.

ICC Interface Link Synchronization

A single device in each group is programmed to be the ICC synchronization master. This device synchronizes the selected data links and aligns the round-robin data transmissions. A single device is configured as the ICC sync master if its selected transmit channel destination (ICC_TX_DEST[3:0]) matches the selected sync master transmit channel (ICC_SYNC_SLOT[3:0]). All other devices in the assigned group are configured as ICC slave devices. The ICC sync master transmit channel setting (ICC_SYNC_SLOT[3:0]) must be identical across all devices in each group, otherwise synchronization is not possible. It is recommended (but not required) that the device with the lowest channel assignment be selected as the ICC sync master.

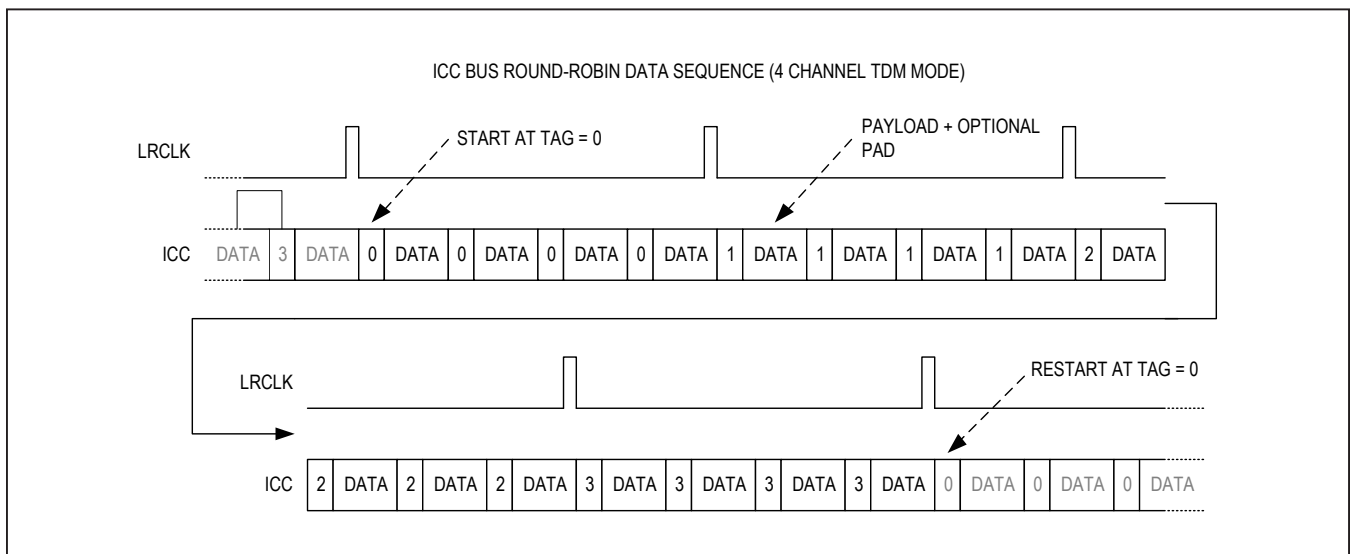

Figure 40. ICC Bus Round-Robin Data Sequence

The ICC synchronization process for a device begins once any data links are enabled (one of more ICC_x_LINK_EN = 1) and the device is not in software shutdown (EN = 1). When this condition is met, a given device attempts ICC synchronization. If ICC synchronization for a given device is not successful before the internal timeout ($16383 / f_{LRCLK}$) expires, then the synchronization process stops and the device generates an ICC synchronization error interrupt (ICC_SYNC_ERR_*, [Device Interrupt Sources](#)). To restart the ICC synchronization process, the host must disable and then re-enable ICC for all timed out devices in an assigned group.

When ICC synchronization is enabled for all devices in an assigned group, synchronization locks on and the round-robin data transmissions begin. If ICC synchronization for all devices in each group is already enabled when the data link of the last device is enabled, then the ICC synchronization lock-on takes no more than 16 frames to complete. If the ICC of the last device in an assigned group is enabled by exiting software shutdown (Setting EN = 1), then the ICC synchronization lock time is negligible relative to the total device turn-on time.

When the ICC synchronization is locked and the round-robin data sequence is active, all devices in a given group must transmit the correct data tags. In any given frame

where an incorrect data tag is present, the grouped devices retain and use the data from the last valid frame of that data type. For the duration of the link, if any combination of devices in each group transmits a combined total of three incorrect data tags, then the synchronization lock is broken. In this case, ICC data transmissions stop and an ICC data error interrupt is generated (ICC_DATA_ERR_*, [Device Interrupt Sources](#)). For any devices where the ICC interface is still enabled, the last valid data for each data type is retained and the synchronization process restarts. A device fully reverts to its own data only if the ICC interface is disabled.

For any device, if all data links are disabled (all ICC_x_LINK_EN = 0) or the device enters a shutdown state (such as by setting EN = 0 or due to an event such as thermal shutdown) the transmitted data tags will be incorrect. This results in the ICC synchronization lock being broken for all devices in the group. The ICC synchronization lock must be restored before the data transmission sequence can resume.

For successful ICC synchronization and for a balanced group response, the host must ensure that the register bits for the following blocks are set to the same values across all devices in an assigned group:

Table 20. Register Settings that Must Match Across an ICC Group

FUNCTIONAL BLOCK	MATCHED FUNCTIONALITY
PCM Interface	All Clock and Data Format Registers
ICC Bus and Data Link Configuration	ALL ICC Registers Except for the Device Specific Transmit Channel
BDE Configuration	All Registers Must Match if the BDE Data Link is Enabled
Limiter Configuration	All Register Must Match if the Limiter Data Link is Enabled
Thermal Foldback Configuration	All Register Must Match if the Thermal-Foldback Data Link is Enabled
DHT Configuration	All Register Must Match if the DHT Data Link is Enabled

ICC Data Link Configuration

REGISTER ADDRESS = 0x2032					DESCRIPTION
BIT	PoR	BIT NAME	TYPE	RES	
7	0	ICC_DHT_CONFIG	RW-R	ICC	ICC DHT Link Configuration Configures the ICC link to react to the highest or lowest DHT value of all devices in the same ICC group 0 = Use the lowest DHT attenuation for the DHT link 1 = Use the highest DHT attenuation for the DHT link
6	0	ICC_LIM_CONFIG	RW-R	ICC	ICC Limiter Link Configuration Configures the ICC link to react to the highest or lowest Limiter value of all devices in the same ICC group. 0 = Use the lowest limiter attenuation for the limiter link 1 = Use the highest limiter attenuation for the limiter link
5	1	ICC_BDE_CONFIG	RW-R	ICC	ICC BDE Link Configuration Configures the ICC link to react to the highest or lowest BDE value of all devices in the same ICC group. 0 = Use the lowest BDE level for the BDE link 1 = Use the highest BDE level for the BDE link
4	1	ICC_THERM_CONFIG	RW-R	ICC	ICC Thermal Link Configuration Configures the ICC link to react to the highest or lowest thermal value of all devices in the same ICC group. 0 = Use the lowest temperature result for the thermal link 1 = Use the highest temperature result for the thermal link
3	0	ICC_DHT_LINK_EN	RW-D	—	ICC DHT Link Enable Enables ICC DHT link between devices. 0 = ICC DHT link disabled 1 = ICC DHT link enabled
2	0	ICC_LIM_LINK_EN	RW-D	—	ICC Limiter Link Enable Enables ICC LIM link between devices. 0 = ICC limiter link disabled 1 = ICC limiter link enabled
1	0	ICC_BDE_LINK_EN	RW-D	—	ICC BDE Link Enable Enables ICC BDE link between devices. 0 = ICC BDE link disabled 1 = ICC BDE link enabled
0	0	ICC_THERM_LINK_EN	RW-D	—	ICC Thermal Link Enable Enables ICC thermal link between devices. 0 = ICC thermal link disabled 1 = ICC thermal link enabled

ICC Receiver Enables 1

REGISTER ADDRESS = 0x202E					DESCRIPTION
BIT	PoR	BIT NAME	TYPE	RES	
7	0	ICC_RX_CH7_EN	RW-R	ICC	ICC Receive Channel 7 Enable 0 = ICC receive channel 7 is disabled 1 = ICC receive channel 7 is enabled
6	0	ICC_RX_CH6_EN	RW-R	ICC	ICC Receive Channel 6 Enable 0 = ICC receive channel 6 is disabled 1 = ICC receive channel 6 is enabled
5	0	ICC_RX_CH5_EN	RW-R	ICC	ICC Receive Channel 5 Enable 0 = ICC receive channel 5 is disabled 1 = ICC receive channel 5 is enabled
4	0	ICC_RX_CH4_EN	RW-R	ICC	ICC Receive Channel 4 Enable 0 = ICC receive channel 4 is disabled 1 = ICC receive channel 4 is enabled
3	0	ICC_RX_CH3_EN	RW-R	ICC	ICC Receive Channel 3 Enable 0 = ICC receive channel 3 is disabled 1 = ICC receive channel 3 is enabled
2	0	ICC_RX_CH2_EN	RW-R	ICC	ICC Receive Channel 2 Enable 0 = ICC receive channel 2 is disabled 1 = ICC receive channel 2 is enabled
1	0	ICC_RX_CH1_EN	RW-R	ICC	ICC Receive Channel 1 Enable 0 = ICC receive channel 1 is disabled 1 = ICC receive channel 1 is enabled
0	0	ICC_RX_CH0_EN	RW-R	ICC	ICC Receive Channel 0 Enable 0 = ICC receive channel 0 is disabled 1 = ICC receive channel 0 is enabled

ICC Receiver Enables 2

REGISTER ADDRESS = 0x202F					DESCRIPTION
BIT	PoR	BIT NAME	TYPE	RES	
7	0	ICC_RX_CH15_EN	RW-R	ICC	ICC Receive Channel 15 Enable 0 = ICC receive channel 15 is disabled 1 = ICC receive channel 15 is enabled
6	0	ICC_RX_CH14_EN	RW-R	ICC	ICC Receive Channel 14 Enable 0 = ICC receive channel 14 is disabled 1 = ICC receive channel 14 is enabled
5	0	ICC_RX_CH13_EN	RW-R	ICC	ICC Receive Channel 13 Enable 0 = ICC receive channel 13 is disabled 1 = ICC receive channel 13 is enabled
4	0	ICC_RX_CH12_EN	RW-R	ICC	ICC Receive Channel 12 Enable 0 = ICC receive channel 12 is disabled 1 = ICC receive channel 12 is enabled
3	0	ICC_RX_CH11_EN	RW-R	ICC	ICC Receive Channel 11 Enable 0 = ICC receive channel 11 is disabled 1 = ICC receive channel 11 is enabled
2	0	ICC_RX_CH10_EN	RW-R	ICC	ICC Receive Channel 10 Enable 0 = ICC receive channel 10 is disabled 1 = ICC receive channel 10 is enabled
1	0	ICC_RX_CH9_EN	RW-R	ICC	ICC Receive Channel 9 Enable 0 = ICC receive channel 9 is disabled 1 = ICC receive channel 9 is enabled
0	0	ICC_RX_CH8_EN	RW-R	ICC	ICC Receive Channel 8 Enable 0 = ICC receive channel 8 is disabled 1 = ICC receive channel 8 is enabled

ICC Transmitter Configuration

REGISTER ADDRESS = 0x2034					DESCRIPTION
BIT	PoR	BIT NAME	TYPE	RES	
7	0	ICC_SYNC_SLOT[3:0]	RW-R	ICC	ICC Synchronization Master Channel Selection Selects the transmit channel for the ICC synchronization master. 0000 = ICC channel 0 0001 = ICC channel 1 ... = ... 1110 = ICC channel 14 1111 = ICC channel 15
6	0				
5	0				
4	0				
3	0	ICC_TX_DEST[3:0]	RW-R	ICC	ICC Data Transmit Channel Selection Selects the device transmit channel for ICC data. 0000 = ICC channel 0 0001 = ICC channel 1 ... = ... 1110 = ICC channel 14 1111 = ICC channel 15
2	0				
1	0				
0	0				

ICC Transmitter Channel Configuration 1

REGISTER ADDRESS = 0x2030					DESCRIPTION
BIT	PoR	BIT NAME	TYPE	RES	
7	1	ICC_TX_CH7_HIZ	RW-R	ICC	ICC Data Transmit Channel 7 Hi-Z Control 0 = Channel 7 drives data (selected as a destination) or zeros (if not) 1 = Channel 7 is Hi-Z
6	1	ICC_TX_CH6_HIZ	RW-R	ICC	ICC Data Transmit Channel 6 Hi-Z Control 0 = Channel 6 drives data (selected as a destination) or zeros (if not) 1 = Channel 6 is Hi-Z
5	1	ICC_TX_CH5_HIZ	RW-R	ICC	ICC Data Transmit Channel 5 Hi-Z Control 0 = Channel 5 drives data (selected as a destination) or zeros (if not) 1 = Channel 5 is Hi-Z
4	1	ICC_TX_CH4_HIZ	RW-R	ICC	ICC Data Transmit Channel 4 Hi-Z Control 0 = Channel 4 drives data (selected as a destination) or zeros (if not) 1 = Channel 4 is Hi-Z
3	1	ICC_TX_CH3_HIZ	RW-R	ICC	ICC Data Transmit Channel 3 Hi-Z Control 0 = Channel 3 drives data (selected as a destination) or zeros (if not) 1 = Channel 3 is Hi-Z
2	1	ICC_TX_CH2_HIZ	RW-R	ICC	ICC Data Transmit Channel 2 Hi-Z Control 0 = Channel 2 drives data (selected as a destination) or zeros (if not) 1 = Channel 2 is Hi-Z
1	1	ICC_TX_CH1_HIZ	RW-R	ICC	ICC Data Transmit Channel 1 Hi-Z Control 0 = Channel 1 drives data (selected as a destination) or zeros (if not) 1 = Channel 1 is Hi-Z
0	1	ICC_TX_CH0_HIZ	RW-R	ICC	ICC Data Transmit Channel 0 Hi-Z Control 0 = Channel 0 drives data (selected as a destination) or zeros (if not) 1 = Channel 0 is Hi-Z

ICC Transmitter Channel Configuration 2

REGISTER ADDRESS = 0x2031					DESCRIPTION
BIT	PoR	BIT NAME	TYPE	RES	
7	1	ICC_TX_CH15_HIZ	RW-R	ICC	ICC Data Transmit Channel 15 Hi-Z Control 0 = Channel 15 drives data (selected as a destination) or zeros (if not) 1 = Channel 15 is Hi-Z
6	1	ICC_TX_CH14_HIZ	RW-R	ICC	ICC Data Transmit Channel 14 Hi-Z Control 0 = Channel 14 drives data (selected as a destination) or zeros (if not) 1 = Channel 14 is Hi-Z
5	1	ICC_TX_CH13_HIZ	RW-R	ICC	ICC Data Transmit Channel 13 Hi-Z Control 0 = Channel 13 drives data (selected as a destination) or zeros (if not) 1 = Channel 13 is Hi-Z
4	1	ICC_TX_CH12_HIZ	RW-R	ICC	ICC Data Transmit Channel 12 Hi-Z Control 0 = Channel 12 drives data (selected as a destination) or zeros (if not) 1 = Channel 12 is Hi-Z
3	1	ICC_TX_CH11_HIZ	RW-R	ICC	ICC Data Transmit Channel 11 Hi-Z Control 0 = Channel 11 drives data (selected as a destination) or zeros (if not) 1 = Channel 11 is Hi-Z
2	1	ICC_TX_CH10_HIZ	RW-R	ICC	ICC Data Transmit Channel 10 Hi-Z Control 0 = Channel 10 drives data (selected as a destination) or zeros (if not) 1 = Channel 10 is Hi-Z
1	1	ICC_TX_CH9_HIZ	RW-R	ICC	ICC Data Transmit Channel 9 Hi-Z Control 0 = Channel 9 drives data (selected as a destination) or zeros (if not) 1 = Channel 9 is Hi-Z
0	1	ICC_TX_CH8_HIZ	RW-R	ICC	ICC Data Transmit Channel 8 Hi-Z Control 0 = Channel 8 drives data (selected as a destination) or zeros (if not) 1 = Channel 8 is Hi-Z

ICC Transmitter Enable

REGISTER ADDRESS = 0x2035					DESCRIPTION
BIT	PoR	BIT NAME	TYPE	RES	
7	0	RESERVED	—	—	Unused Returns 0 if read.
6	0				
5	0				
4	0				
3	0				
2	0				
1	0				
0	0	ICC_TX_EN	RW-R	ICC	ICC Transmit Control Select whether the ICC pin transmitter is enabled/disabled. 0 = ICC transmit disabled 1 = ICC transmit enabled

Layout and Grounding

Proper layout and grounding are essential for optimum performance. Use at least four PCB layers, and add thermal vias to the ground/power plane close to the device to ensure good thermal performance and high-end output power. Good grounding improves audio performance and prevents switching noise from coupling into the audio signal. Ground the power signals and the analog signals of the IC separately at the system ground plane, to prevent switching interference from corrupting sensitive analog signals. Place the recommended supply decoupling capacitors as close as possible to the IC. The PVDD to PGND connection must be kept short and should have minimum trace length and loop area to ensure optimal performance. Use wide, low-resistance output, supply and ground traces. As load impedance decreases, the current drawn from the device outputs increase. At higher current, the resistance of the output traces decreases the power delivered to the load. For example, if 2W is delivered from the speaker output to a 4Ω load through a

100mΩ trace, 49mW is consumed in the trace. If power is delivered through a 10mΩ trace, only 5mW is consumed in the trace. Wide output, supply, and ground traces also improve the power dissipation of the device. The device is inherently designed for excellent RF immunity. For best performance, add ground fills around all signal traces on the top and bottom PCB planes. It is advisable to follow the layout of the MAX98374 EV kit as closely as possible in the application. Thermal and performance measurements shown in this data sheet were measured with a 6-layer board with 2 signal layers and 4 ground layers. As a result, the EV kit performance is likely better than what can be achieved with a JEDEC standard board.

WLP Applications Information

For the latest application details on WLP construction, dimensions, tape carrier information, PCB techniques, bump-pad layout, and recommended reflow temperature profile, as well as the latest information on reliability testing results, refer to the [Application Note 1891: Wafer-Level Packaging \(WLP\) and its Applications](#).

Table 21. Recommended External Components

BUMP	VALUE	SIZE	VOLTAGE RATING (V)	DIELECTRIC
PVDD	10μF	0603	25	X5R
PVDD	10μF	0603	25	X5R
PVDD	0.1μF	0402	25	X5R
PVDD	0.1μF	0402	25	X5R
PVDD	220μF	—	35	Alum-Elec
VREFC	10μF+30Ω	0201	12	X5R
DVDD	1μF	0201	6.3	X5R

See the [Typical Application Circuit](#) for component placement.

Table 22. Unused Connections

WLP	FCQFN	NAME	CONNECTION
E1	20	I.C.	Connect to DVDD
A3	10	IRQ	Leave unconnected if unused
D5	3	DOUT	Leave unconnected if unused
E4	2	ICC	Connect to DGND if unused
B4	7	LRCLK	Connect to DGND if unused

Typical Application Circuit

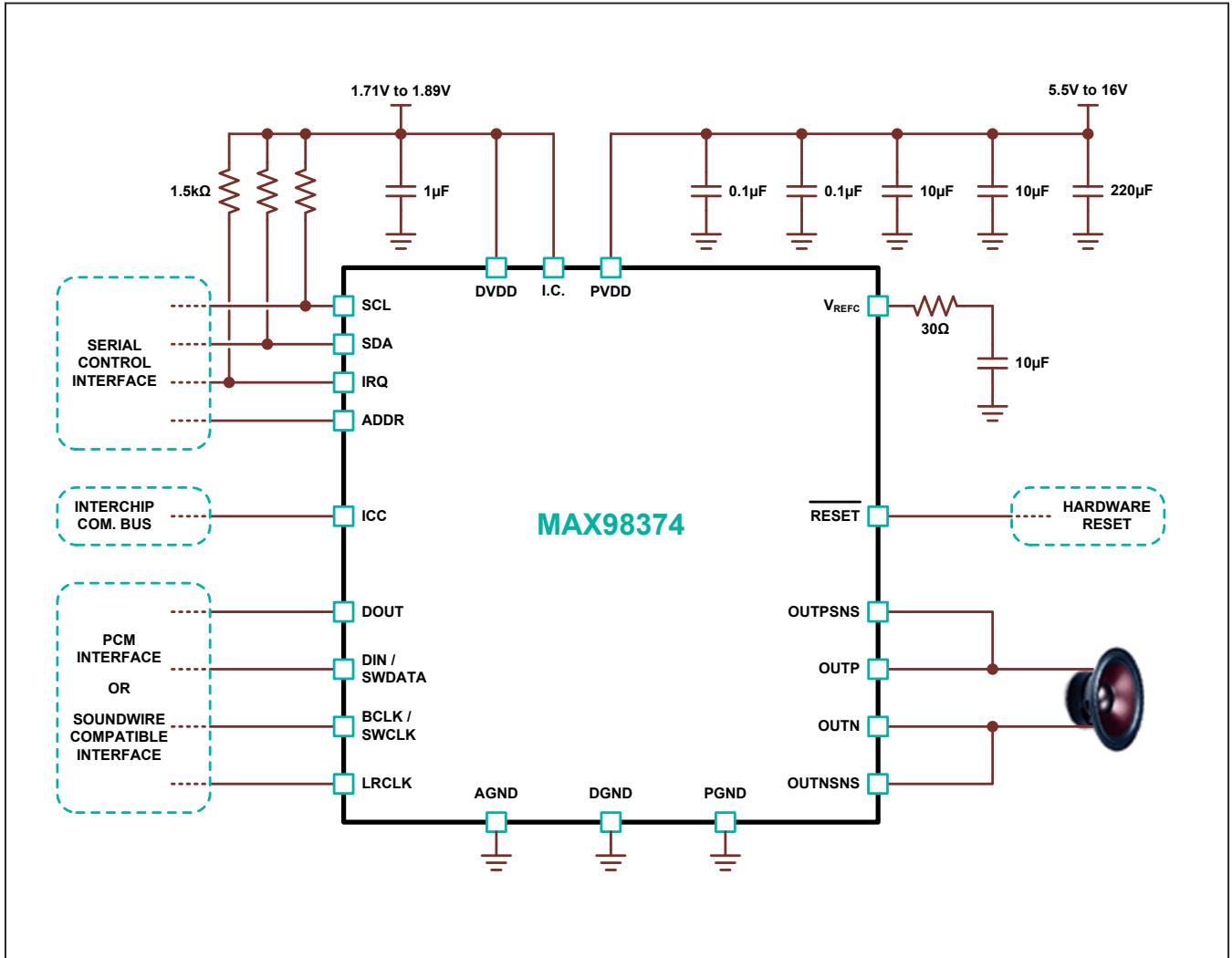

Revision Identification Number

The device provides a register containing the device revision identification number. The revision identification

number reflects the current physical hardware version and is updated with any hardware revision ([Device Revision Identification Number](#)).

Device Revision Identification Number

REGISTER ADDRESS = 0x21FF					DESCRIPTION
BIT	PoR	BIT NAME	TYPE	RES	
7	0	REV_ID[7:0]	R	—	Device Revision Identification Number Revision of the device. Updated at every device revision.
6	1				
5	0				
4	0				
3	0				
2	0				
1	1				
0	1				

Ordering Information

PART NUMBER	TEMP RANGE	PIN-PACKAGE
MAX98374EWA+T	-40°C to +85°C	25 WLP
MAX98374EWA+	-40°C to +85°C	25 WLP
MAX98374EFF+T	-40°C to +85°C	22 FCQFN
MAX98374EFF+	-40°C to +85°C	22 FCQFN

+Denotes a lead(Pb) free/ROHS compliant package.

T = Tape and reel.

Chip Information

PROCESS: CMOS

Package Information

For the latest package outline information and land patterns (footprints), go to www.maximintegrated.com/packages. Note that a "+", "#", or "-" in the package code indicates RoHS status only. Package drawings may show a different suffix character, but the drawing pertains to the package regardless of RoHS status.

PACKAGE TYPE	PACKAGE CODE	OUTLINE NO.	LAND PATTERN NO.
25 WLP	W252C2-2	21-100162	Refer to: Application Note 1891
22 FCQFN	F223A3F+1	21-100223	90-100080

Revision History

REVISION NUMBER	REVISION DATE	DESCRIPTION	PAGES CHANGED
0	3/18	Initial release	—

For pricing, delivery, and ordering information, please contact Maxim Direct at 1-888-629-4642, or visit Maxim Integrated's website at www.maximintegrated.com.

Maxim Integrated cannot assume responsibility for use of any circuitry other than circuitry entirely embodied in a Maxim Integrated product. No circuit patent licenses are implied. Maxim Integrated reserves the right to change the circuitry and specifications without notice at any time. The parametric values (min and max limits) shown in the Electrical Characteristics table are guaranteed. Other parametric values quoted in this data sheet are provided for guidance.



Компания «ЭлектроПласт» предлагает заключение долгосрочных отношений при поставках импортных электронных компонентов на взаимовыгодных условиях!

Наши преимущества:

- Оперативные поставки широкого спектра электронных компонентов отечественного и импортного производства напрямую от производителей и с крупнейших мировых складов;
- Поставка более 17-ти миллионов наименований электронных компонентов;
- Поставка сложных, дефицитных, либо снятых с производства позиций;
- Оперативные сроки поставки под заказ (от 5 рабочих дней);
- Экспресс доставка в любую точку России;
- Техническая поддержка проекта, помощь в подборе аналогов, поставка прототипов;
- Система менеджмента качества сертифицирована по Международному стандарту ISO 9001;
- Лицензия ФСБ на осуществление работ с использованием сведений, составляющих государственную тайну;
- Поставка специализированных компонентов (Xilinx, Altera, Analog Devices, Intersil, Interpoint, Microsemi, Aeroflex, Peregrine, Syfer, Eurofarad, Texas Instrument, Miteq, Cobham, E2V, MA-COM, Hittite, Mini-Circuits, General Dynamics и др.);

Помимо этого, одним из направлений компании «ЭлектроПласт» является направление «Источники питания». Мы предлагаем Вам помощь Конструкторского отдела:

- Подбор оптимального решения, техническое обоснование при выборе компонента;
- Подбор аналогов;
- Консультации по применению компонента;
- Поставка образцов и прототипов;
- Техническая поддержка проекта;
- Защита от снятия компонента с производства.



Как с нами связаться

Телефон: 8 (812) 309 58 32 (многоканальный)

Факс: 8 (812) 320-02-42

Электронная почта: org@eplast1.ru

Адрес: 198099, г. Санкт-Петербург, ул. Калинина, дом 2, корпус 4, литера А.