

Panasonic

2014

CATALOG

Electrolytic Capacitors
(Radial Lead Type Aluminum Electrolytic Capacitors)



Small can type Aluminum Electrolytic Capacitors

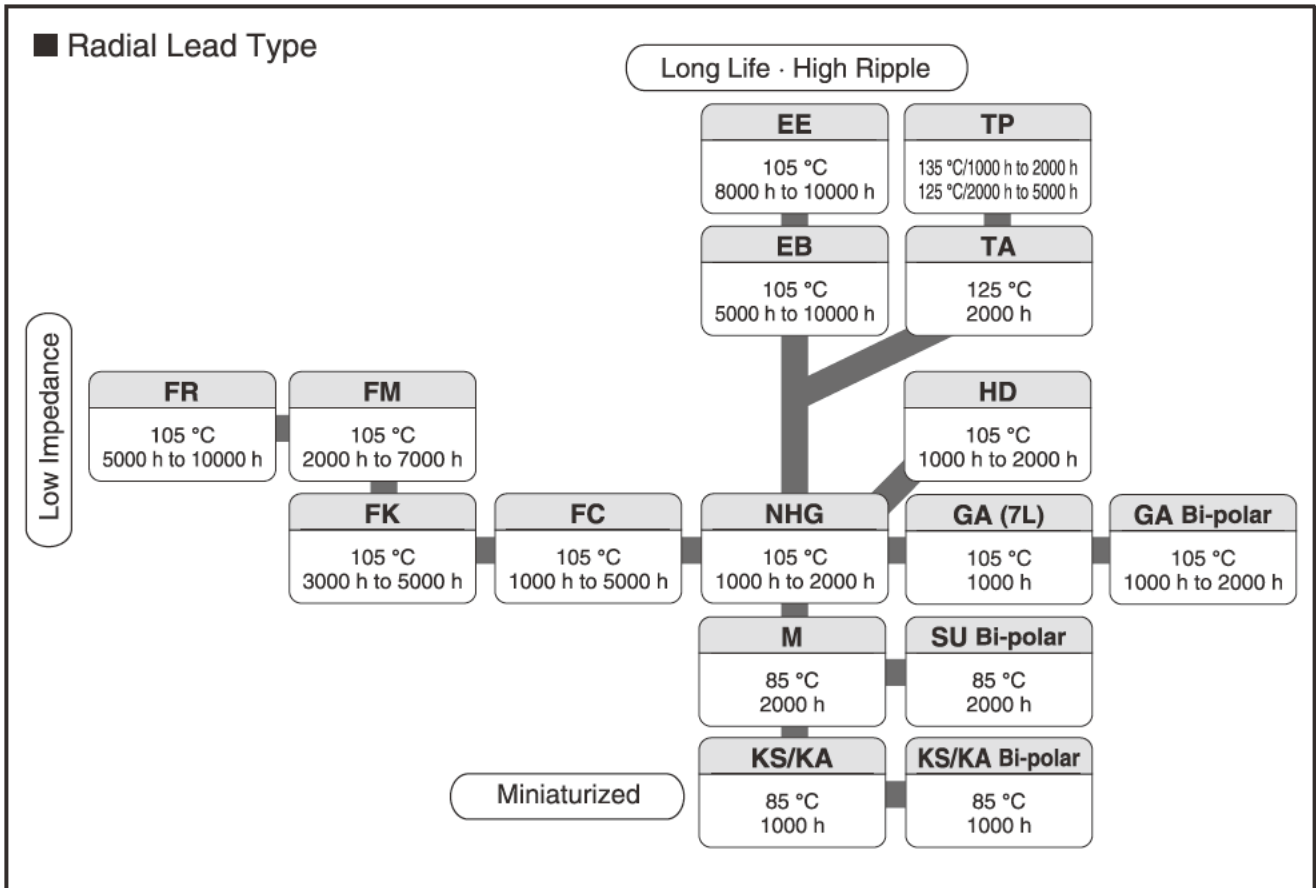

Radial Lead Type

Series: **FC** Type: **A**



■ Features

- Endurance : 105 °C 1000 h to 5000 h
- Low impedance
- AEC-Q200 qualified*
- RoHS directive compliant

■ Specifications

Category Temp. Range	-55 °C to +105 °C									
Rated W.V. Range	6.3 V.DC to 100 V.DC									
Nominal Cap. Range	2.2 μF to 15000 μF									
Capacitance Tolerance	±20 % (120 Hz/+20 °C)									
DC Leakage Current	$I \leq 0.01 CV$ or 3 (μA) After 2 minutes (Whichever is greater)									
tan δ	W.V. (V)	6.3	10	16	25	35	50	63	100	(120 Hz/+20 °C)
	tan δ	0.22	0.19	0.16	0.14	0.12	0.10	0.08	0.07	
For capacitance value $\geq 1000 \mu\text{F}$, add 0.02 per every 1000 μF .										
Endurance	After following life test with DC voltage and +105 °C±2 °C ripple current value applied (The sum of DC and ripple peak voltage shall not exceed the rated working voltage) when the capacitors are restored to 20 °C, the capacitors shall meet the limits specified below. Duration : φ4 to φ6.3: 1000 hours, φ8: 2000 hours, φ10: 3000 hours, φ12.5 to φ18: 5000 hours									
	Capacitance change	±20 % of initial measured value								
	tan δ	≤ 200 % of initial specified value								
	DC leakage current	≤ initial specified value								
Shelf Life	After storage for 1000 hours at +105 °C±2 °C with no voltage applied and then being stabilized at +20 °C, capacitors shall meet the limits specified in Endurance. (With voltage treatment)									

■ Frequency correction factor for ripple current

W.V.(V.DC)	Cap (μF)	Frequency (Hz)				
		60	120	1 k	10 k	100 k
6.3 to 100	2.2 to 330	0.55	0.65	0.85	0.90	1.00
	390 to 1000	0.70	0.75	0.90	0.95	1.00
	1200 to 2200	0.75	0.80	0.90	0.95	1.00
	2700 to 15000	0.80	0.85	0.95	1.00	1.00

■ Dimensions in mm (not to scale)

(Unit : mm)

*L≤16 : L±1.0 (*φ8×15, φ16×15, φ18×15 : L±1.5)
L≥20 : L±2.0

	L≥11								L=7		
Body Dia. φD	4	5	6.3	8	10	12.5	16	18	4	5	6.3
Body Length L						15 to 25	30 to 40				
Lead Dia. φd	0.45	0.5	0.5	0.6	0.6	0.6	0.8	0.8	0.45	0.45	0.45
Lead space F	1.5	2.0	2.5	3.5	5.0	5.0	5.0	7.5	7.5	1.5	2.0

* This product qualify for AEC-Q200, but it has some deviations.

Design and specifications are each subject to change without notice. Ask factory for the current technical specifications before purchase and/or use. Should a safety concern arise regarding this product, please be sure to contact us immediately.

■ Case size/ Impedance/ Ripple Current

W.V(V.DC) Case size (ϕ D×L)	6.3 V to 35 V			50 V			63 V			100 V		
	Impedance (Ω)/(100 kHz)		Ripple Current (mA r.m.s) (/100 kHz)	Impedance (Ω)/(100 kHz)		Ripple Current (mA r.m.s) (/100 kHz)	Impedance (Ω)/(100 kHz)		Ripple Current (mA r.m.s) (/100 kHz)	Impedance (Ω)/(100 kHz)		Ripple Current (mA r.m.s) (/100 kHz)
	20 °C	-10 °C		20 °C	-10 °C		20 °C	-10 °C		20 °C	-10 °C	
4 × 7	2.00	5.00	65									
5 × 7	0.950	2.40	120									
6.3 × 7	0.450	1.20	200									
4 × 11	1.30	2.60	120	2.50	5.00	90	3.50	7.00	80			
5 × 11	0.800	1.60	175	*	*	*	2.00	4.00	145	4.10	8.20	80
5 × 15	0.500	1.00	235	0.900	1.80	215	1.30	2.60	200	2.80	5.60	90
6.3 × 11.2	0.350	0.700	290	0.600	1.20	260	1.00	2.00	240	1.80	3.60	114
6.3 × 15	0.250	0.500	400	0.400	0.800	360	0.700	1.40	330	1.10	2.20	155
8 × 11.5	0.117	0.234	555	0.234	0.468	485	0.342	0.684	405	0.680	1.36	260
8 × 15	0.085	0.170	730	0.155	0.310	635	0.230	0.460	535	0.450	0.900	340
8 × 20	0.065	0.130	995	0.120	0.240	860	0.178	0.356	690	0.330	0.660	455
10 × 12.5	0.090	0.180	755	0.162	0.324	615	0.256	0.512	535	0.530	1.06	306
10 × 16	0.068	0.136	1050	0.119	0.238	850	0.194	0.388	600	0.360	0.720	400
10 × 20	0.052	0.104	1220	0.090	0.180	1030	0.147	0.294	885	0.240	0.480	463
10 × 25	0.045	0.090	1440	0.082	0.164	1200	0.130	0.260	1050	0.210	0.420	599
10 × 30	0.035	0.070	1815	0.060	0.120	1610	0.090	0.180	1300	0.150	0.300	698
12.5 × 15	0.065	0.130	1205	0.110	0.220	1150	0.150	0.300	1020	0.230	0.460	511
12.5 × 20	0.038	0.076	1655	0.063	0.126	1480	0.085	0.170	1285	0.180	0.360	671
12.5 × 25	0.030	0.060	1945	0.050	0.100	1832	0.070	0.140	1720	0.110	0.220	807
12.5 × 30	0.025	0.050	2310	0.040	0.080	2215	0.055	0.110	2090	0.098	0.196	937
12.5 × 35	0.022	0.044	2510	0.034	0.068	2285	0.047	0.094	2265	0.087	0.174	1040
12.5 × 40	0.018	0.036	2655	0.030	0.060	2590	0.042	0.084	2560	0.072	0.144	1130
16 × 15	0.043	0.086	1690	0.080	0.160	1610	0.090	0.180	1410	0.140	0.280	793
16 × 20	0.029	0.058	2205	0.048	0.096	1835	0.059	0.118	1765	0.110	0.220	995
16 × 25	0.022	0.044	2555	0.034	0.068	2235	0.050	0.100	2160	0.089	0.178	1170
16 × 31.5	0.018	0.036	3010	0.028	0.056	2700	0.043	0.086	2670	0.062	0.124	1520
16 × 35.5	0.016	0.032	3150	0.025	0.050	2790	0.036	0.072	2770	0.053	0.106	1730
16 × 40	0.015	0.030	3360	0.023	0.046	2845	0.030	0.060	2825	0.047	0.094	1920
18 × 15	0.038	0.076	2000	0.068	0.136	1900	0.086	0.172	1690	0.120	0.240	917
18 × 20	0.028	0.056	2490	0.042	0.084	2420	0.055	0.110	2290	0.080	0.160	1230
18 × 25	0.020	0.040	2740	0.029	0.058	2610	0.043	0.086	2585	0.070	0.140	1420
18 × 31.5	0.016	0.032	3635	0.025	0.050	3000	0.032	0.064	2950	0.062	0.124	1600
18 × 35.5	0.015	0.030	3680	0.023	0.046	3100	0.030	0.060	3095	0.041	0.082	1770
18 × 40	0.014	0.028	3735	-	-	-	0.025	0.050	3205	0.036	0.072	2300

*

Case size (ϕ D×L)	Capacitance (μ F)	Impedance (Ω)/(100 kHz)		Ripple Current (mA r.m.s)(100 kHz)
		20 °C	-10 °C	
5 × 11	1.0	2.40	4.80	20
	2.2	1.80	3.60	45
	3.3	1.30	2.60	65
	4.7	1.30	2.60	95
	10	1.30	2.60	125
	12	1.30	2.60	135
	15	1.30	2.60	145
	18	1.30	2.60	155
	22	1.30	2.60	155

Design and specifications are each subject to change without notice. Ask factory for the current technical specifications before purchase and/or use.
Should a safety concern arise regarding this product, please be sure to contact us immediately.

Standard Products

Endurance : 105 °C ϕ 4 to ϕ 6.3=1000 h, ϕ 8=2000 h, ϕ 10=3000 h, ϕ 12.5 to ϕ 18=5000 h

W.V. (V)	Cap. (\pm 20 %) (μ F)	Case size		Specification			Lead Length				Part No.	Min. Packaging Qty	
		Dia. (mm)	Length (mm)	Ripple Current (100 kHz) (+105 °C) (mA r.m.s.)	Impedance (100 kHz) (+20 °C) (Ω)	Endurance (hours)	Lead Dia. (mm)	Lead Space				Straight Leads (pcs)	Taping (pcs)
								Straight (mm)	Taping *B (mm)	Taping *H (mm)			
6.3	27	4	7	65	2.000	1000	0.45	1.5	5.0	2.5	EEAFC0J270()	200	2000
	56	5	7	120	0.950	1000	0.45	2.0	5.0	2.5	EEAFC0J560()	200	2000
	68	4	11	120	1.300	1000	0.45	1.5	5.0	2.5	EEUFC0J680()***	200	2000
	100	5	11	175	0.800	1000	0.50	2.0	5.0	2.5	EEUFC0J101()	200	2000
	120	6.3	7	200	0.450	1000	0.45	2.5	5.0	2.5	EEAFC0J121()	200	2000
	150	5	15	235	0.500	1000	0.50	2.0	5.0	2.5	EEUFC0J151()***	200	2000
	220	6.3	11.2	290	0.350	1000	0.50	2.5	5.0	2.5	EEUFC0J221()	200	2000
	270	6.3	11.2	290	0.350	1000	0.50	2.5	5.0	2.5	EEUFC0J271()	200	2000
	330	6.3	11.2	290	0.350	1000	0.50	2.5	5.0	2.5	EEUFC0J331S()	200	2000
		6.3	15	400	0.250	1000	0.50	2.5	5.0	2.5	EEUFC0J331()***	200	2000
	390	8	11.5	555	0.117	2000	0.60	3.5	5.0		EEUFC0J391()	200	1000
	470	8	11.5	555	0.117	2000	0.60	3.5	5.0		EEUFC0J471()	200	1000
	560	8	11.5	555	0.117	2000	0.60	3.5	5.0		EEUFC0J561()	200	1000
	820	8	15	730	0.085	2000	0.60	3.5	5.0		EEUFC0J821L()	200	1000
		10	12.5	755	0.090	3000	0.60	5.0	5.0		EEUFC0J821()	200	500
	1000	10	12.5	755	0.090	3000	0.60	5.0	5.0		EEUFC0J102()	200	500
	1200	8	20	995	0.065	2000	0.60	3.5	5.0		EEUFC0J122L()	200	1000
		10	16	1050	0.068	3000	0.60	5.0	5.0		EEUFC0J122()	200	500
	1500	10	20	1220	0.052	3000	0.60	5.0	5.0		EEUFC0J152()	200	500
		12.5	15	1205	0.065	5000	0.60	5.0	5.0		EEUFC0J152S()	200	500
	1800	10	25	1440	0.045	3000	0.60	5.0	5.0		EEUFC0J182()	200	500
	2200	10	25	1440	0.045	3000	0.60	5.0	5.0		EEUFC0J222()	200	500
		16	15	1690	0.043	5000	0.80	7.5	7.5		EEUFC0J222S()	100	250
	2700	10	30	1815	0.035	3000	0.60	5.0			EEUFC0J272L	100	
		12.5	20	1655	0.038	5000	0.60	5.0	5.0		EEUFC0J272()	200	500
		16	15	1690	0.043	5000	0.80	7.5	7.5		EEUFC0J272S()	100	250
	3300	12.5	20	1655	0.038	5000	0.60	5.0	5.0		EEUFC0J332()	200	500
		18	15	2000	0.038	5000	0.80	7.5	7.5		EEUFC0J332S()	100	250
	3900	12.5	25	1945	0.030	5000	0.60	5.0	5.0		EEUFC0J392()	200	500
	4700	12.5	30	2310	0.025	5000	0.80	5.0			EEUFC0J472	100	
16		20	2205	0.029	5000	0.80	7.5	7.5		EEUFC0J472S()	100	250	
5600	12.5	35	2510	0.022	5000	0.80	5.0			EEUFC0J562L	100		
	16	20	2205	0.029	5000	0.80	7.5	7.5		EEUFC0J562()	100	250	
6800	12.5	40	2655	0.018	5000	0.80	5.0			EEUFC0J682L	100		
	16	25	2555	0.022	5000	0.80	7.5	7.5		EEUFC0J682()	100	250	
	18	20	2490	0.028	5000	0.80	7.5	7.5		EEUFC0J682S()	100	250	
8200	16	31.5	3010	0.018	5000	0.80	7.5			EEUFC0J822	100		
10000	16	35.5	3150	0.016	5000	0.80	7.5			EEUFC0J103	100		
	18	25	2740	0.020	5000	0.80	7.5	7.5		EEUFC0J103S()	100	250	
12000	16	40	3360	0.015	5000	0.80	7.5			EEUFC0J123L	100		
	18	31.5	3635	0.016	5000	0.80	7.5			EEUFC0J123	50		
15000	18	35.5	3680	0.015	5000	0.80	7.5			EEUFC0J153	50		

· When requesting taped product, please put the letter "B" or "H" between the "()". Lead wire pitch *B=5 mm, 7.5 mm, H=2.5 mm.

· Please refer to the page of "Taping Dimensions".

*** Please kindly accept last shipment : 30/Jun/2015

Standard Products

Endurance : 105 °C ϕ 4 to ϕ 6.3=1000 h, ϕ 8=2000 h, ϕ 10=3000 h, ϕ 12.5 to ϕ 18=5000 h

W.V. (V)	Cap. (\pm 20 %) (μ F)	Case size		Specification			Lead Length				Part No.	Min. Packaging Qty	
		Dia. (mm)	Length (mm)	Ripple Current (100 kHz) (+105 °C) (mA r.m.s.)	Impedance (100 kHz) (+20 °C) (Ω)	Endurance (hours)	Lead Dia. (mm)	Lead Space				Straight Leads (pcs)	Taping (pcs)
								Straight (mm)	Taping *B (mm)	Taping *H (mm)			
10	22	4	7	65	2.000	1000	0.45	1.5	5.0	2.5	EEAFC1A220()	200	2000
	39	5	7	120	0.950	1000	0.45	2.0	5.0	2.5	EEAFC1A390()	200	2000
	47	4	11	120	1.300	1000	0.45	1.5	5.0	2.5	EEUFC1A470()***	200	2000
	82	5	11	175	0.800	1000	0.50	2.0	5.0	2.5	EEUFC1A820()	200	2000
		6.3	7	200	0.450	1000	0.45	2.5	5.0	2.5	EEAFC1A820()	200	2000
	100	5	11	175	0.800	1000	0.50	2.0	5.0	2.5	EEUFC1A101S()	200	2000
		5	15	235	0.500	1000	0.50	2.0	5.0	2.5	EEUFC1A101()***	200	2000
	150	6.3	11.2	290	0.350	1000	0.50	2.5	5.0	2.5	EEUFC1A151()	200	2000
	180	6.3	11.2	290	0.350	1000	0.50	2.5	5.0	2.5	EEUFC1A181()	200	2000
	220	6.3	11.2	290	0.350	1000	0.50	2.5	5.0	2.5	EEUFC1A221S()	200	2000
		6.3	15	400	0.250	1000	0.50	2.5	5.0	2.5	EEUFC1A221()***	200	2000
	330	8	11.5	555	0.117	2000	0.60	3.5	5.0		EEUFC1A331()	200	1000
	390	8	11.5	555	0.117	2000	0.60	3.5	5.0		EEUFC1A391()	200	1000
	470	8	11.5	555	0.117	2000	0.60	3.5	5.0		EEUFC1A471()	200	1000
	560	10	12.5	755	0.090	3000	0.60	5.0	5.0		EEUFC1A561()	200	500
	680	8	15	730	0.085	2000	0.60	3.5	5.0		EEUFC1A681L()	200	1000
		10	12.5	755	0.090	3000	0.60	5.0	5.0		EEUFC1A681()	200	500
	820	10	16	1050	0.068	3000	0.60	5.0	5.0		EEUFC1A821()	200	500
	1000	8	20	995	0.065	2000	0.60	3.5	5.0		EEUFC1A102L()	200	1000
		10	16	1050	0.068	3000	0.60	5.0	5.0		EEUFC1A102()	200	500
	1200	10	20	1220	0.052	3000	0.60	5.0	5.0		EEUFC1A122()	200	500
		12.5	15	1205	0.065	5000	0.60	5.0	5.0		EEUFC1A122S()	200	500
	1500	10	25	1440	0.045	3000	0.60	5.0	5.0		EEUFC1A152()	200	500
	1800	12.5	20	1655	0.038	5000	0.60	5.0	5.0		EEUFC1A182()	200	500
		16	15	1690	0.043	5000	0.80	7.5	7.5		EEUFC1A182S()	100	250
	2200	10	30	1815	0.035	3000	0.60	5.0			EEUFC1A222L	100	
		12.5	20	1655	0.038	5000	0.60	5.0	5.0		EEUFC1A222()	200	500
	2700	12.5	25	1945	0.030	5000	0.60	5.0	5.0		EEUFC1A272()	200	500
		18	15	2000	0.038	5000	0.80	7.5	7.5		EEUFC1A272S()	100	250
	3300	12.5	30	2310	0.025	5000	0.80	5.0			EEUFC1A332	100	
16		20	2205	0.029	5000	0.80	7.5	7.5		EEUFC1A332S()	100	250	
3900	12.5	35	2510	0.022	5000	0.80	5.0			EEUFC1A392L	100		
	16	20	2205	0.029	5000	0.80	7.5	7.5		EEUFC1A392()	100	250	
4700	12.5	40	2655	0.018	5000	0.80	5.0			EEUFC1A472L	100		
	16	25	2555	0.022	5000	0.80	7.5	7.5		EEUFC1A472()	100	250	
5600	16	25	2555	0.022	5000	0.80	7.5	7.5		EEUFC1A562()	100	250	
	18	20	2490	0.028	5000	0.80	7.5	7.5		EEUFC1A562S()	100	250	
6800	16	31.5	3010	0.018	5000	0.80	7.5			EEUFC1A682	100		
	18	25	2740	0.020	5000	0.80	7.5	7.5		EEUFC1A682S()	100	250	
8200	16	35.5	3150	0.016	5000	0.80	7.5			EEUFC1A822L	100		
	18	31.5	3635	0.016	5000	0.80	7.5			EEUFC1A822	50		
10000	18	35.5	3680	0.015	5000	0.80	7.5			EEUFC1A103	50		
12000	18	40	3735	0.014	5000	0.80	7.5			EEUFC1A123	50		

· When requesting taped product, please put the letter "B" or "H" between the "()". Lead wire pitch *B=5 mm, 7.5 mm, H=2.5 mm.
· Please refer to the page of "Taping Dimensions".

*** Please kindly accept last shipment : 30/Jun/2015

Standard Products

Endurance : 105 °C ϕ 4 to ϕ 6.3=1000 h, ϕ 8=2000 h, ϕ 10=3000 h, ϕ 12.5 to ϕ 18=5000 h

W.V. (V)	Cap. (\pm 20 %) (μ F)	Case size		Specification			Lead Length				Part No.	Min. Packaging Qty	
		Dia. (mm)	Length (mm)	Ripple Current (100 kHz) (+105 °C) (mA r.m.s.)	Impedance (100 kHz) (+20 °C) (Ω)	Endurance (hours)	Lead Dia. (mm)	Lead Space				Straight Leads (pcs)	Taping (pcs)
								Straight (mm)	Taping *B (mm)	Taping *H (mm)			
16	15	4	7	65	2.000	1000	0.45	1.5	5.0	2.5	EEAFC1C150()	200	2000
	27	5	7	120	0.950	1000	0.45	2.0	5.0	2.5	EEAFC1C270()	200	2000
	39	4	11	120	1.30	1000	0.45	1.5	5.0	2.5	EEUFC1C390()***	200	2000
	47	5	11	175	0.800	1000	0.50	2.0	5.0	2.5	EEUFC1C470()	200	2000
	56	5	11	175	0.800	1000	0.50	2.0	5.0	2.5	EEUFC1C560()	200	2000
		6.3	7	200	0.450	1000	0.45	2.5	5.0	2.5	EEAFC1C560()	200	2000
	68	5	11	175	0.800	1000	0.50	2.0	5.0	2.5	EEUFC1C680()	200	2000
	82	5	15	235	0.500	1000	0.50	2.0	5.0	2.5	EEUFC1C820()***	200	2000
	100	6.3	11.2	290	0.350	1000	0.50	2.5	5.0	2.5	EEUFC1C101()	200	2000
	120	6.3	11.2	290	0.350	1000	0.50	2.5	5.0	2.5	EEUFC1C121()	200	2000
	180	6.3	15	400	0.250	1000	0.50	2.5	5.0	2.5	EEUFC1C181()***	200	2000
	220	8	11.5	555	0.117	2000	0.60	3.5	5.0		EEUFC1C221()	200	1000
	270	8	11.5	555	0.117	2000	0.60	3.5	5.0		EEUFC1C271()	200	1000
	330	8	11.5	555	0.117	2000	0.60	3.5	5.0		EEUFC1C331()	200	1000
	390	10	12.5	755	0.090	3000	0.60	5.0	5.0		EEUFC1C391()	200	500
	470	8	15	730	0.085	2000	0.60	3.5	5.0		EEUFC1C471L()	200	1000
		10	12.5	755	0.090	3000	0.60	5.0	5.0		EEUFC1C471()	200	500
	560	10	16	1050	0.068	3000	0.60	5.0	5.0		EEUFC1C561()	200	500
	680	8	20	995	0.065	2000	0.60	3.5	5.0		EEUFC1C681L()	200	1000
		10	16	1050	0.068	3000	0.60	5.0	5.0		EEUFC1C681()	200	500
	820	10	20	1220	0.052	3000	0.60	5.0	5.0		EEUFC1C821()	200	500
		12.5	15	1205	0.065	5000	0.60	5.0	5.0		EEUFC1C821S()	200	500
	1000	10	20	1220	0.052	3000	0.60	5.0	5.0		EEUFC1C102S()	200	500
		10	25	1440	0.045	3000	0.60	5.0	5.0		EEUFC1C102()	200	500
	1200	10	25	1440	0.045	3000	0.60	5.0	5.0		EEUFC1C122()	200	500
		16	15	1690	0.043	5000	0.80	7.5	7.5		EEUFC1C122S()	100	250
	1500	10	30	1815	0.035	3000	0.60	5.0			EEUFC1C152L	100	
		12.5	20	1655	0.038	5000	0.60	5.0	5.0		EEUFC1C152()	200	500
	16	16	15	1690	0.043	5000	0.80	7.5	7.5		EEUFC1C152S()	100	250
	1800	12.5	25	1945	0.030	5000	0.60	5.0	5.0		EEUFC1C182()	200	500
18		15	2000	0.038	5000	0.80	7.5	7.5		EEUFC1C182S()	100	250	
2200	12.5	25	1945	0.030	5000	0.60	5.0	5.0		EEUFC1C222()	200	500	
	16	20	2205	0.029	5000	0.80	7.5	7.5		EEUFC1C222S()	100	250	
2700	12.5	30	2310	0.025	5000	0.80	5.0			EEUFC1C272L	100		
	16	20	2205	0.029	5000	0.80	7.5	7.5		EEUFC1C272()	100	250	
3300	12.5	35	2510	0.022	5000	0.80	5.0			EEUFC1C332	100		
	18	20	2490	0.028	5000	0.80	7.5	7.5		EEUFC1C332S()	100	250	
3900	16	25	2555	0.022	5000	0.80	7.5	7.5		EEUFC1C392()	100	250	
	18	20	2490	0.028	5000	0.80	7.5	7.5		EEUFC1C392S()	100	250	
4700	16	31.5	3010	0.018	5000	0.80	7.5			EEUFC1C472	100		
	18	25	2740	0.020	5000	0.80	7.5	7.5		EEUFC1C472S()	100	250	
5600	16	35.5	3150	0.016	5000	0.80	7.5			EEUFC1C562L	100		
	18	31.5	3635	0.016	5000	0.80	7.5			EEUFC1C562	50		
6800	16	40	3360	0.015	5000	0.80	7.5			EEUFC1C682	100		
8200	18	35.5	3680	0.015	5000	0.80	7.5			EEUFC1C822	50		

· When requesting taped product, please put the letter "B" or "H" between the "()". Lead wire pitch *B=5 mm, 7.5 mm, H=2.5 mm.

· Please refer to the page of "Taping Dimensions".

*** Please kindly accept last shipment : 30/Jun/2015

Standard Products

Endurance : 105 °C ϕ 4 to ϕ 6.3=1000 h, ϕ 8=2000 h, ϕ 10=3000 h, ϕ 12.5 to ϕ 18=5000 h

W.V. (V)	Cap. (\pm 20 %) (μ F)	Case size		Specification			Lead Length				Part No.	Min. Packaging Qty	
		Dia. (mm)	Length (mm)	Ripple Current (100 kHz) (+105 °C) (mA r.m.s.)	Impedance (100 kHz) (+20 °C) (Ω)	Endurance (hours)	Lead Dia. (mm)	Lead Space				Straight Leads (pcs)	Taping (pcs)
								Straight (mm)	Taping *B (mm)	Taping *H (mm)			
25	10	4	7	65	2.000	1000	0.45	1.5	5.0	2.5	EEAFC1E100()	200	2000
	22	5	7	120	0.950	1000	0.45	2.0	5.0	2.5	EEAFC1E220()	200	2000
	27	4	11	120	1.30	1000	0.45	1.5	5.0	2.5	EEUFC1E270()***	200	2000
	39	5	11	175	0.800	1000	0.50	2.0	5.0	2.5	EEUFC1E390()	200	2000
		6.3	7	200	0.450	1000	0.45	2.5	5.0	2.5	EEAFC1E390()	200	2000
	47	5	11	175	0.800	1000	0.50	2.0	5.0	2.5	EEUFC1E470()	200	2000
	56	5	15	235	0.500	1000	0.50	2.0	5.0	2.5	EEUFC1E560()***	200	2000
	82	6.3	11.2	290	0.350	1000	0.50	2.5	5.0	2.5	EEUFC1E820()	200	2000
	100	6.3	11.2	290	0.350	1000	0.50	2.5	5.0	2.5	EEUFC1E101S()	200	2000
	120	6.3	15	400	0.250	1000	0.50	2.5	5.0	2.5	EEUFC1E121()***	200	2000
	180	8	11.5	555	0.117	2000	0.60	3.5	5.0		EEUFC1E181()	200	1000
	220	8	11.5	555	0.117	2000	0.60	3.5	5.0		EEUFC1E221()	200	1000
	270	10	12.5	755	0.090	3000	0.60	5.0	5.0		EEUFC1E271()	200	500
	330	8	15	730	0.085	2000	0.60	3.5	5.0		EEUFC1E331L()	200	1000
		10	12.5	755	0.090	3000	0.60	5.0	5.0		EEUFC1E331()	200	500
	390	10	16	1050	0.068	3000	0.60	5.0	5.0		EEUFC1E391()	200	500
	470	8	20	995	0.065	2000	0.60	3.5	5.0		EEUFC1E471L()	200	1000
		10	16	1050	0.068	3000	0.60	5.0	5.0		EEUFC1E471()	200	500
	560	10	20	1220	0.052	3000	0.60	5.0	5.0		EEUFC1E561()	200	500
		12.5	15	1205	0.065	5000	0.60	5.0	5.0		EEUFC1E561S()	200	500
	680	10	20	1220	0.052	3000	0.60	5.0	5.0		EEUFC1E681()	200	500
	820	10	25	1440	0.045	3000	0.60	5.0	5.0		EEUFC1E821()	200	500
		12.5	20	1655	0.038	5000	0.60	5.0	5.0		EEUFC1E821S()	200	500
	1000	10	30	1815	0.035	3000	0.60	5.0			EEUFC1E102L	100	
		12.5	20	1655	0.038	5000	0.60	5.0	5.0		EEUFC1E102()	200	500
		16	15	1690	0.043	5000	0.80	7.5	7.5		EEUFC1E102S()	100	250
	1200	12.5	25	1945	0.030	5000	0.60	5.0	5.0		EEUFC1E122()	200	500
		18	15	2000	0.038	5000	0.80	7.5	7.5		EEUFC1E122S()	100	250
	1500	12.5	25	1945	0.030	5000	0.60	5.0	5.0		EEUFC1E152()	200	500
		16	20	2205	0.029	5000	0.80	7.5	7.5		EEUFC1E152S()	100	250
1800	12.5	30	2310	0.025	5000	0.80	5.0			EEUFC1E182L	100		
	16	20	2205	0.029	5000	0.80	7.5	7.5		EEUFC1E182()	100	250	
2200	12.5	35	2510	0.022	5000	0.80	5.0			EEUFC1E222	100		
	18	20	2490	0.028	5000	0.80	7.5	7.5		EEUFC1E222S()	100	250	
2700	16	25	2555	0.022	5000	0.80	7.5	7.5		EEUFC1E272()	100	250	
3300	16	31.5	3010	0.018	5000	0.80	7.5			EEUFC1E332	100		
	18	25	2740	0.020	5000	0.80	7.5	7.5		EEUFC1E332S()	100	250	
3900	16	35.5	3150	0.016	5000	0.80	7.5			EEUFC1E392L	100		
	18	31.5	3635	0.016	5000	0.80	7.5			EEUFC1E392	50		
4700	18	35.5	3680	0.015	5000	0.80	7.5			EEUFC1E472	50		
5600	18	40	3735	0.014	5000	0.80	7.5			EEUFC1E562	50		

· When requesting taped product, please put the letter "B" or "H" between the "()". Lead wire pitch *B=5 mm, 7.5 mm, H=2.5 mm.

· Please refer to the page of "Taping Dimensions".

*** Please kindly accept last shipment : 30/Jun/2015

Standard Products

Endurance : 105 °C ϕ 4 to ϕ 6.3=1000 h, ϕ 8=2000 h, ϕ 10=3000 h, ϕ 12.5 to ϕ 18=5000 h

W.V. (V)	Cap. (\pm 20 %) (μ F)	Case size		Specification			Lead Length				Part No.	Min. Packaging Qty	
		Dia. (mm)	Length (mm)	Ripple Current (100 kHz) (+105 °C) (mA r.m.s.)	Impedance (100 kHz) (+20 °C) (Ω)	Endurance (hours)	Lead Dia. (mm)	Lead Space				Straight Leads (pcs)	Taping (pcs)
								Straight (mm)	Taping *B (mm)	Taping *H (mm)			
35	6.8	4	7	65	2.000	1000	0.45	1.5	5.0	2.5	EEAFC1V6R8()	200	2000
	12	5	7	120	0.950	1000	0.45	2.0	5.0	2.5	EEAFC1V120()	200	2000
	18	4	11	120	1.300	1000	0.45	1.5	5.0	2.5	EEUFC1V180()***	200	2000
	22	5	11	175	0.800	1000	0.50	2.0	5.0	2.5	EEUFC1V220()	200	2000
	27	5	11	175	0.800	1000	0.50	2.0	5.0	2.5	EEUFC1V270()	200	2000
		6.3	7	200	0.450	1000	0.45	2.5	5.0	2.5	EEAFC1V270()	200	2000
	33	5	11	175	0.080	1000	0.50	2.0	5.0	2.5	EEUFC1V330()	200	2000
	39	5	15	235	0.500	1000	0.50	2.0	5.0	2.5	EEUFC1V390()***	200	2000
	47	6.3	11.2	290	0.350	1000	0.50	2.5	5.0	2.5	EEUFC1V470()	200	2000
	56	6.3	11.2	290	0.350	1000	0.50	2.5	5.0	2.5	EEUFC1V560()	200	2000
	68	6.3	11.2	290	0.350	1000	0.50	2.5	5.0	2.5	EEUFC1V680()	200	2000
	82	6.3	15	400	0.250	1000	0.50	2.5	5.0	2.5	EEUFC1V820()***	200	2000
	100	8	11.5	555	0.117	2000	0.60	3.5	5.0		EEUFC1V101()	200	1000
	120	8	11.5	555	0.117	2000	0.60	3.5	5.0		EEUFC1V121()	200	1000
	150	8	11.5	555	0.117	2000	0.60	3.5	5.0		EEUFC1V151()	200	1000
	180	10	12.5	755	0.090	3000	0.60	5.0	5.0		EEUFC1V181()	200	500
	220	8	15	730	0.085	2000	0.60	3.5	5.0		EEUFC1V221L()	200	1000
		10	12.5	755	0.090	3000	0.60	5.0	5.0		EEUFC1V221()	200	500
	270	10	16	1050	0.068	3000	0.60	5.0	5.0		EEUFC1V271()	200	500
	330	8	20	995	0.065	2000	0.60	3.5	5.0		EEUFC1V331L()	200	1000
		10	16	1050	0.068	3000	0.60	5.0	5.0		EEUFC1V331()	200	500
	390	10	20	1220	0.052	3000	0.60	5.0	5.0		EEUFC1V391()	200	500
		12.5	15	1205	0.065	5000	0.60	5.0	5.0		EEUFC1V391S()	200	500
	470	10	20	1220	0.052	3000	0.60	5.0	5.0		EEUFC1V471()	200	500
	560	10	25	1440	0.045	3000	0.60	5.0	5.0		EEUFC1V561()	200	500
		12.5	20	1655	0.038	5000	0.60	5.0	5.0		EEUFC1V561S()	200	500
	680	10	30	1815	0.035	3000	0.60	5.0			EEUFC1V681L	100	
		12.5	20	1655	0.038	5000	0.60	5.0	5.0		EEUFC1V681()	200	500
		16	15	1690	0.043	5000	0.80	7.5	7.5		EEUFC1V681S()	100	250
	820	12.5	25	1945	0.030	5000	0.60	5.0	5.0		EEUFC1V821L()	200	500
		18	15	2000	0.038	5000	0.80	7.5	7.5		EEUFC1V821()	100	250
	1000	12.5	25	1945	0.030	5000	0.60	5.0	5.0		EEUFC1V102()	200	500
		16	20	2205	0.029	5000	0.80	7.5	7.5		EEUFC1V102S()	100	250
1200	12.5	30	2310	0.025	5000	0.80	5.0			EEUFC1V122L	100		
	16	20	2205	0.029	5000	0.80	7.5	7.5		EEUFC1V122()	100	250	
1500	12.5	35	2510	0.022	5000	0.80	5.0			EEUFC1V152L	100		
	16	25	2555	0.022	5000	0.80	7.5	7.5		EEUFC1V152()	100	250	
	18	20	2490	0.028	5000	0.80	7.5	7.5		EEUFC1V152S()	100	250	
1800	12.5	40	2655	0.018	5000	0.80	5.0			EEUFC1V182L	100		
	16	25	2555	0.022	5000	0.80	7.5	7.5		EEUFC1V182()	100	250	
	18	20	2490	0.028	5000	0.80	7.5	7.5		EEUFC1V182S()	100	250	
2200	16	31.5	3010	0.018	5000	0.80	7.5			EEUFC1V222	100		
	18	25	2740	0.020	5000	0.80	7.5	7.5		EEUFC1V222S()	100	250	
2700	16	35.5	3150	0.016	5000	0.80	7.5			EEUFC1V272L	100		
	18	31.5	3635	0.016	5000	0.80	7.5			EEUFC1V272	50		
3300	18	35.5	3680	0.015	5000	0.80	7.5			EEUFC1V332	50		
3900	18	40	3735	0.014	5000	0.80	7.5			EEUFC1V392	50		

· When requesting taped product, please put the letter "B" or "H" between the "()". Lead wire pitch *B=5 mm, 7.5 mm, H=2.5 mm.

· Please refer to the page of "Taping Dimensions".

*** Please kindly accept last shipment : 30/Jun/2015

Standard Products

Endurance : 105 °C ϕ 4 to ϕ 6.3=1000 h, ϕ 8=2000 h, ϕ 10=3000 h, ϕ 12.5 to ϕ 18=5000 h

W.V. (V)	Cap. (\pm 20 %) (μ F)	Case size		Specification			Lead Length				Part No.	Min. Packaging Qty	
		Dia. (mm)	Length (mm)	Ripple Current (100 kHz) (+105 °C) (mA r.m.s.)	Impedance (100 kHz) (+20 °C) (Ω)	Endurance (hours)	Lead Dia. (mm)	Lead Space				Straight Leads (pcs)	Taping (pcs)
								Straight (mm)	Taping *B (mm)	Taping *H (mm)			
50	1.0	5	11	20	2.400	1000	0.50	2.0	5.0	2.5	EEUFC1H1R0()**	200	2000
	2.2	5	11	45	1.800	1000	0.50	2.0	5.0	2.5	EEUFC1H2R2()	200	2000
	3.3	5	11	65	1.300	1000	0.50	2.0	5.0	2.5	EEUFC1H3R3()	200	2000
	4.7	5	11	95	1.300	1000	0.50	2.0	5.0	2.5	EEUFC1H4R7()	200	2000
	10	4	11	90	2.500	1000	0.45	1.5	5.0	2.5	EEUFC1H100()***	200	2000
		5	11	125	1.300	1000	0.50	2.0	5.0	2.5	EEUFC1H100L()	200	2000
	12	5	11	135	1.300	1000	0.50	2.0	5.0	2.5	EEUFC1H120()	200	2000
	15	5	11	145	1.300	1000	0.50	2.0	5.0	2.5	EEUFC1H150()	200	2000
	18	5	11	155	1.300	1000	0.50	2.0	5.0	2.5	EEUFC1H180()	200	2000
	22	5	11	155	1.300	1000	0.50	2.0	5.0	2.5	EEUFC1H220()	200	2000
	27	5	15	215	0.900	1000	0.50	2.0	5.0	2.5	EEUFC1H270()***	200	2000
	33	6.3	11.2	260	0.600	1000	0.50	2.5	5.0	2.5	EEUFC1H330()	200	2000
	39	6.3	11.2	260	0.600	1000	0.50	2.5	5.0	2.5	EEUFC1H390()	200	2000
	47	6.3	11.2	260	0.600	1000	0.50	2.5	5.0	2.5	EEUFC1H470()	200	2000
	56	6.3	15	360	0.400	1000	0.50	2.5	5.0	2.5	EEUFC1H560()***	200	2000
	68	8	11.5	485	0.234	2000	0.60	3.5	5.0		EEUFC1H680()	200	1000
	82	8	11.5	485	0.234	2000	0.60	3.5	5.0		EEUFC1H820()	200	1000
	100	10	12.5	615	0.162	3000	0.60	5.0	5.0		EEUFC1H101()	200	500
	120	8	15	635	0.155	2000	0.60	3.5	5.0		EEUFC1H121L()	200	1000
		10	12.5	615	0.162	3000	0.60	5.0	5.0		EEUFC1H121()	200	500
	150	10	16	850	0.119	3000	0.60	5.0	5.0		EEUFC1H151()	200	500
	180	8	20	860	0.120	2000	0.60	3.5	5.0		EEUFC1H181L()	200	1000
		10	16	850	0.119	3000	0.60	5.0	5.0		EEUFC1H181()	200	500
	220	10	20	1030	0.090	3000	0.60	5.0	5.0		EEUFC1H221()	200	500
		12.5	15	1150	0.110	5000	0.60	5.0	5.0		EEUFC1H221S()	200	500
	270	10	25	1200	0.082	3000	0.60	5.0	5.0		EEUFC1H271()	200	500
	330	10	30	1610	0.060	3000	0.60	5.0			EEUFC1H331L	100	
		12.5	20	1480	0.063	5000	0.60	5.0	5.0		EEUFC1H331()	200	500
	390	12.5	20	1480	0.063	5000	0.60	5.0	5.0		EEUFC1H391()	200	500
		16	15	1610	0.080	5000	0.80	7.5	7.5		EEUFC1H391S()	100	250
470	10	30	1610	0.060	3000	0.60	5.0			EEUFC1H471L	100		
	12.5	25	1832	0.050	5000	0.60	5.0	5.0		EEUFC1H471()	200	500	
560	12.5	25	1832	0.050	5000	0.60	5.0	5.0		EEUFC1H561()	200	500	
	18	15	1900	0.068	5000	0.80	7.5	7.5		EEUFC1H561S()	100	250	
680	12.5	30	2215	0.040	5000	0.80	5.0			EEUFC1H681L	100		
	16	20	1835	0.048	5000	0.80	7.5	7.5		EEUFC1H681()	100	250	
820	12.5	35	2285	0.034	5000	0.80	5.0			EEUFC1H821L	100		
	18	20	2420	0.042	5000	0.80	7.5	7.5		EEUFC1H821()	100	250	
1000	12.5	40	2590	0.030	5000	0.80	5.0			EEUFC1H102L	100		
	16	25	2235	0.034	5000	0.80	7.5	7.5		EEUFC1H102()	100	250	
1200	16	31.5	2700	0.028	5000	0.80	7.5			EEUFC1H122	100		
	18	25	2610	0.029	5000	0.80	7.5	7.5		EEUFC1H122S()	100	250	
1500	16	35.5	2790	0.025	5000	0.80	7.5			EEUFC1H152L	100		
1800	16	40	2845	0.023	5000	0.80	7.5			EEUFC1H182L	100		
	18	31.5	3000	0.025	5000	0.80	7.5			EEUFC1H182	50		
2200	18	35.5	3100	0.023	5000	0.80	7.5			EEUFC1H222	50		

· When requesting taped product, please put the letter "B" or "H" between the "()". Lead wire pitch *B=5 mm, 7.5 mm, H=2.5 mm.
· Please refer to the page of "Taping Dimensions".

** Please kindly accept last shipment : 31/Mar/2015

*** Please kindly accept last shipment : 30/Jun/2015

Standard Products

Endurance : 105 °C ϕ 4 to ϕ 6.3=1000 h, ϕ 8=2000 h, ϕ 10=3000 h, ϕ 12.5 to ϕ 18=5000 h

W.V. (V)	Cap. (\pm 20 %) (μ F)	Case size		Specification			Lead Length				Part No.	Min. Packaging Q'ty	
		Dia. (mm)	Length (mm)	Ripple Current (100 kHz) (+105 °C) (mA r.m.s.)	Impedance (100 kHz) (+20 °C) (Ω)	Endurance (hours)	Lead Dia. (mm)	Lead Space				Straight Leads (pcs)	Taping (pcs)
								Straight (mm)	Taping *B (mm)	Taping *H (mm)			
63	6.8	4	11	80	3.500	1000	0.45	1.5	5.0	2.5	EEUFC1J6R8()***	200	2000
	12	5	11	145	2.000	1000	0.50	2.0	5.0	2.5	EEUFC1J120()	200	2000
	18	5	15	200	1.300	1000	0.50	2.0	5.0	2.5	EEUFC1J180()***	200	2000
	22	6.3	11.2	240	1.000	1000	0.50	2.5	5.0	2.5	EEUFC1J220()	200	2000
	33	6.3	11.2	240	1.000	1000	0.50	2.5	5.0	2.5	EEUFC1J330()	200	2000
	39	6.3	15	330	0.700	1000	0.50	2.5	5.0	2.5	EEUFC1J390()***	200	2000
	47	8	11.5	405	0.342	2000	0.60	3.5	5.0		EEUFC1J470()	200	1000
	56	8	11.5	405	0.342	2000	0.60	3.5	5.0		EEUFC1J560()	200	1000
	68	8	11.5	405	0.342	2000	0.60	3.5	5.0		EEUFC1J680()	200	1000
	82	10	12.5	535	0.256	3000	0.60	5.0	5.0		EEUFC1J820()	200	500
	100	8	15	535	0.230	2000	0.60	3.5	5.0		EEUFC1J101L()	200	1000
		10	12.5	535	0.256	3000	0.60	5.0	5.0		EEUFC1J101()	200	500
	120	10	16	600	0.194	3000	0.60	5.0	5.0		EEUFC1J121()	200	500
	150	8	20	690	0.178	2000	0.60	3.5	5.0		EEUFC1J151()	200	1000
	180	10	20	885	0.147	3000	0.60	5.0	5.0		EEUFC1J181()	200	500
		12.5	15	1020	0.150	5000	0.60	5.0	5.0		EEUFC1J181S()	200	500
	220	10	20	885	0.147	3000	0.60	5.0	5.0		EEUFC1J221X()	200	500
		10	25	1050	0.130	3000	0.60	5.0	5.0		EEUFC1J221()	200	500
		12.5	20	1285	0.085	5000	0.60	5.0	5.0		EEUFC1J221S()	200	500
	270	16	15	1410	0.090	5000	0.80	7.5	7.5		EEUFC1J271()	100	250
	330	10	30	1300	0.090	3000	0.60	5.0			EEUFC1J331L	100	
		12.5	20	1285	0.085	5000	0.60	5.0	5.0		EEUFC1J331()	200	500
	390	12.5	25	1720	0.070	5000	0.60	5.0	5.0		EEUFC1J391()	200	500
		18	15	1690	0.086	5000	0.80	7.5	7.5		EEUFC1J391S()	100	250
	470	12.5	30	2090	0.055	5000	0.80	5.0			EEUFC1J471L	100	
		16	20	1765	0.059	5000	0.80	7.5	7.5		EEUFC1J471()	100	250
	560	16	25	2160	0.050	5000	0.80	7.5	7.5		EEUFC1J561()	100	250
	680	12.5	35	2265	0.047	5000	0.80	5.0			EEUFC1J681L	100	
		16	25	2160	0.050	5000	0.80	7.5	7.5		EEUFC1J681()	100	250
		18	20	2290	0.055	5000	0.80	7.5	7.5		EEUFC1J681S()	100	250
820	12.5	40	2560	0.042	5000	0.80	5.0			EEUFC1J821L	100		
	16	31.5	2670	0.043	5000	0.80	7.5			EEUFC1J821	100		
	18	25	2585	0.043	5000	0.80	7.5	7.5		EEUFC1J821S()	100	250	
1000	16	31.5	2670	0.043	5000	0.80	7.5			EEUFC1J102U	100		
	16	35.5	2770	0.036	5000	0.80	7.5			EEUFC1J102	100		
1200	16	40	2825	0.030	5000	0.80	7.5			EEUFC1J122L	100		
	18	31.5	2950	0.032	5000	0.80	7.5			EEUFC1J122	50		
1500	18	35.5	3095	0.030	5000	0.80	7.5			EEUFC1J152	50		
1800	18	40	3205	0.025	5000	0.80	7.5			EEUFC1J182	50		

· When requesting taped product, please put the letter "B" or "H" between the "()". Lead wire pitch *B=5 mm, 7.5 mm, H=2.5 mm.
 · Please refer to the page of "Taping Dimensions".

*** Please kindly accept last shipment : 30/Jun/2015

Standard Products

Endurance : 105 °C ϕ 4 to ϕ 6.3=1000 h, ϕ 8=2000 h, ϕ 10=3000 h, ϕ 12.5 to ϕ 18=5000 h

W.V. (V)	Cap. (\pm 20 %) (μ F)	Case size		Specification			Lead Length				Part No.	Min. Packaging Qty	
		Dia. (mm)	Length (mm)	Ripple Current (100 kHz) (+105 °C) (mA r.m.s.)	Impedance (100 kHz) (+20 °C) (Ω)	Endurance (hours)	Lead Dia. (mm)	Lead Space				Straight Leads (pcs)	Taping (pcs)
								Straight (mm)	Taping *B (mm)	Taping *H (mm)			
100	5.6	5	11	80	4.10	1000	0.5	2.0	5.0	2.5	EEUFC2A5R6()	200	2000
	8.2	5	15	90	2.80	1000	0.5	2.0	5.0	2.5	EEUFC2A8R2()***	200	2000
	12	6.3	11.2	114	1.80	1000	0.5	2.5	5.0	2.5	EEUFC2A120()	200	2000
	18	6.3	15	155	1.10	1000	0.5	2.5	5.0	2.5	EEUFC2A180()***	200	2000
	22	8	11.5	260	0.680	2000	0.6	3.5	5.0		EEUFC2A220()	200	1000
	33	8	15	340	0.450	2000	0.6	3.5	5.0		EEUFC2A330L()	200	1000
		10	12.5	306	0.530	3000	0.6	5.0	5.0		EEUFC2A330()	200	500
	39	8	20	455	0.330	2000	0.6	5.0	5.0		EEUFC2A390L()	200	1000
		10	16	400	0.360	3000	0.6	5.0	5.0		EEUFC2A390()	200	500
	56	10	20	463	0.240	3000	0.6	5.0	5.0		EEUFC2A560()	200	500
	68	10	25	599	0.210	3000	0.6	5.0	5.0		EEUFC2A680L()	200	500
		12.5	15	511	0.230	5000	0.6	5.0	5.0		EEUFC2A680()	200	500
	100	10	30	698	0.150	3000	0.6	5.0			EEUFC2A101L	100	
		12.5	20	671	0.180	5000	0.6	5.0	5.0		EEUFC2A101()	200	500
	120	16	15	793	0.140	5000	0.8	7.5	7.5		EEUFC2A121S()	100	250
	150	12.5	25	807	0.110	5000	0.6	5.0	5.0		EEUFC2A151()	200	500
		18	15	917	0.120	5000	0.8	7.5	7.5		EEUFC2A151S()	100	250
	180	12.5	30	937	0.098	5000	0.8	5.0			EEUFC2A181L	100	
		16	20	995	0.110	5000	0.8	7.5	7.5		EEUFC2A181()	100	250
	220	12.5	35	1040	0.087	5000	0.8	5.0			EEUFC2A221L	100	
		16	25	1170	0.089	5000	0.8	7.5	7.5		EEUFC2A221()	100	250
	270	12.5	40	1130	0.072	5000	0.8	5.0			EEUFC2A271L	100	
		18	20	1230	0.080	5000	0.8	7.5	7.5		EEUFC2A271S()	100	250
	330	16	31.5	1520	0.062	5000	0.8	7.5			EEUFC2A331	100	
18		25	1420	0.070	5000	0.8	7.5	7.5		EEUFC2A331S()	100	250	
390	16	35.5	1730	0.053	5000	0.8	7.5			EEUFC2A391L	100		
	18	31.5	1600	0.062	5000	0.8	7.5			EEUFC2A391	50		
470	16	40	1920	0.047	5000	0.8	7.5			EEUFC2A471	100		
560	18	35.5	1770	0.041	5000	0.8	7.5			EEUFC2A561	50		
680	18	40	2300	0.036	5000	0.8	7.5			EEUFC2A681	50		

· When requesting taped product, please put the letter "B" or "H" between the "()". Lead wire pitch *B=5 mm, 7.5 mm, H=2.5 mm.
· Please refer to the page of "Taping Dimensions".

*** Please kindly accept last shipment : 30/Jun/2015

Radial Lead Type

Series: **FK** Type: **A**

■ Features

- Low impedance (10 % to 30 % less than FC Series)
Miniaturization (30 % to 40 % less than FC Series)
- Endurance : 3000 h to 5000 h at +105 °C
- AEC-Q200 qualified*
- RoHS directive compliant



■ Specifications

Category Temp. Range	-55 °C to +105 °C						
Rated W.V. Range	6.3 V.DC to 35 V.DC						
Nominal Cap. Range	180 μF to 12000 μF						
Capacitance Tolerance	±20 % (120 Hz/+20 °C)						
DC Leakage Current	$I \leq 0.01 CV$ (μA) After 2 minutes						
tan δ	W.V.	6.3	10	16	25	35	(120 Hz/+20 °C)
	tan δ	0.22	0.19	0.16	0.14	0.12	
Add 0.02 per 1000 μF for products of 1000 μF or more.							
Endurance	After following life test with DC voltage and +105 °C±2 °C ripple current value applied (The sum of DC and ripple peak voltage shall not exceed the rated working voltage), when the capacitors are restored to 20 °C, the capacitors shall meet the limits specified bellow. Duration : φ8: 3000 hours , φ10: 4000 hours , φ12.5 to φ18: 5000 hours						
	Capacitance change	±20 % of initial measured value					
	tan δ	≤ 200 % of initial specified value					
	DC leakage current	≤ initial specified value					
Shelf Life	After storage for 1000 hours at +105 °C±2 °C with no voltage applied and then being stabilized at +20 °C, capacitors shall meet the limits specified in Endurance. (With voltage treatment)						

■ Frequency correction factor for ripple current

W.V.(V.DC)	Cap (μF)	Frequency (Hz)				
		60	120	1 k	10 k	100 k
6.3 to 35	180 to 330	0.60	0.70	0.85	0.95	1.00
	390 to 1000	0.65	0.75	0.90	0.98	1.00
	1200 to 12000	0.75	0.80	0.95	1.00	1.00

■ Dimensions in mm (not to scale)

(Unit : mm)

	8	10	12.5	16	18
Body Dia. φD	8	10	12.5	16	18
Body Length L	—	—	12.5 to 25	30 to 40	—
Lead Dia. φd	0.6	0.6	0.6	0.8	0.8
Lead space F	3.5	5.0	5.0	5.0	7.5

* This product qualify for AEC-Q200, but it has some deviations.

Design and specifications are each subject to change without notice. Ask factory for the current technical specifications before purchase and/or use.
Should a safety concern arise regarding this product, please be sure to contact us immediately.

01 May. 2014

■ Case size/Impedance/Ripple current

Case size (ϕ D×L)	Impedance (Ω)/(100 kHz)		Ripple Current (mA r.m.s.)/(100 kHz)
	+20 °C	-10 °C	+105 °C
8 × 11.5	0.090	0.180	630
8 × 15	0.062	0.124	860
8 × 20	0.044	0.088	1220
10 × 12.5	0.063	0.126	900
10 × 16	0.049	0.098	1240
10 × 20	0.035	0.070	1490
10 × 25	0.033	0.066	1680
10 × 30	0.025	0.050	2140
12.5 × 15	0.048	0.096	1400
12.5 × 20	0.029	0.058	1890
12.5 × 25	0.022	0.044	2280
12.5 × 30	0.018	0.036	2720
12.5 × 35	0.016	0.032	2940
12.5 × 40	0.014	0.028	3010
16 × 15	0.038	0.076	1800
16 × 20	0.026	0.052	2330
16 × 25	0.019	0.038	2760
18 × 15	0.036	0.072	2060
18 × 20	0.025	0.050	2640
18 × 25	0.018	0.036	2850

Standard Products

Endurance : 105 °C ϕ 8=3000 h, ϕ 10=4000 h, ϕ 12.5 to ϕ 18=5000 h

W.V.	Cap. (±20 %)	Case size		Specification			Lead Length			Part No.	Min. Packaging Q'ty	
		Dia.	Length	Ripple Current (100 kHz) (+105 °C) (mA r.m.s.)	Impedance (100 kHz) (+20 °C) (Ω)	Endurance (hours)	Lead Dia.	Lead Space			Straight Leads (pcs)	Taping (pcs)
								Straight	Taping *B			
(V)	(μ F)	(mm)	(mm)	(mA r.m.s.)	(Ω)	(hours)	(mm)	(mm)	(mm)		(pcs)	(pcs)
6.3	680	8	11.5	630	0.090	3000	0.6	3.5	5.0	EEUFK0J681()	200	1000
	1000	8	15	860	0.062	3000	0.6	3.5	5.0	EEUFK0J102L()	200	1000
		10	12.5	900	0.063	4000	0.6	5.0	5.0	EEUFK0J102()	200	500
	1500	8	20	1220	0.044	3000	0.6	3.5	5.0	EEUFK0J152L()	200	1000
		10	16	1240	0.049	4000	0.6	5.0	5.0	EEUFK0J152()	200	500
	1800	12.5	15	1400	0.048	5000	0.6	5.0	5.0	EEUFK0J182S()	200	500
	2200	10	20	1490	0.035	4000	0.6	5.0	5.0	EEUFK0J222()	200	500
		10	25	1680	0.033	4000	0.6	5.0	5.0	EEUFK0J222L()	200	500
	3300	10	30	2140	0.025	4000	0.6	5.0		EEUFK0J332L	100	
		12.5	20	1890	0.029	5000	0.6	5.0	5.0	EEUFK0J332()	200	500
		16	15	1800	0.038	5000	0.8	7.5	7.5	EEUFK0J332S()	100	250
	4700	12.5	25	2280	0.022	5000	0.6	5.0	5.0	EEUFK0J472()	200	500
		18	15	2060	0.036	5000	0.8	7.5	7.5	EEUFK0J472S()	100	250
	5600	12.5	30	2720	0.018	5000	0.8	5.0		EEUFK0J562L	100	
		16	20	2330	0.026	5000	0.8	7.5	7.5	EEUFK0J562S()	100	250
	6800	12.5	35	2940	0.016	5000	0.8	5.0		EEUFK0J682L	100	
	8200	12.5	40	3010	0.014	5000	0.8	5.0		EEUFK0J822L	100	
		16	25	2760	0.019	5000	0.8	7.5	7.5	EEUFK0J822()	100	250
18		20	2640	0.025	5000	0.8	7.5	7.5	EEUFK0J822S()	100	250	
12000	18	25	2850	0.018	5000	0.8	7.5	7.5	EEUFK0J123S()	100	250	
10	560	8	11.5	630	0.090	3000	0.6	3.5	5.0	EEUFK1A561()	200	1000
	820	8	15	860	0.062	3000	0.6	3.5	5.0	EEUFK1A821L()	200	1000
		10	12.5	900	0.063	4000	0.6	5.0	5.0	EEUFK1A821()	200	500
	1200	8	20	1220	0.044	3000	0.6	3.5	5.0	EEUFK1A122L()	200	1000
		10	16	1240	0.049	4000	0.6	5.0	5.0	EEUFK1A122()	200	500
	1500	12.5	15	1400	0.048	5000	0.6	5.0	5.0	EEUFK1A152S()	200	500
	1800	10	20	1490	0.035	4000	0.6	5.0	5.0	EEUFK1A182()	200	500
		10	25	1680	0.033	4000	0.6	5.0	5.0	EEUFK1A182L()	200	500
	2700	10	30	2140	0.025	4000	0.6	5.0		EEUFK1A272L	100	
		12.5	20	1890	0.029	5000	0.6	5.0	5.0	EEUFK1A272()	200	500
		16	15	1800	0.038	5000	0.8	7.5	7.5	EEUFK1A272S()	100	250
	3900	12.5	25	2280	0.022	5000	0.6	5.0	5.0	EEUFK1A392()	200	500
		18	15	2060	0.036	5000	0.8	7.5	7.5	EEUFK1A392S()	100	250
	4700	12.5	30	2720	0.018	5000	0.8	5.0		EEUFK1A472L	100	
		16	20	2330	0.026	5000	0.8	7.5	7.5	EEUFK1A472S()	100	250
	5600	12.5	35	2940	0.016	5000	0.8	5.0		EEUFK1A562L	100	
	6800	12.5	40	3010	0.014	5000	0.8	5.0		EEUFK1A682L	100	
		16	25	2760	0.019	5000	0.8	7.5	7.5	EEUFK1A682()	100	250
18		20	2640	0.025	5000	0.8	7.5	7.5	EEUFK1A682S()	100	250	
8200	18	25	2850	0.018	5000	0.8	7.5	7.5	EEUFK1A822S()	100	250	

- When requesting taped product, please put the letter "B" between the "()". Lead wire pitch *B=5 mm, 7.5 mm.
- Please refer to the page of "Taping Dimensions".

Standard Products

Endurance : 105 °C $\phi 8=3000$ h, $\phi 10=4000$ h, $\phi 12.5$ to $\phi 18=5000$ h

W.V. (V)	Cap. ($\pm 20\%$) (μF)	Case size		Specification			Lead Length			Part No.	Min. Packaging Q'ty	
		Dia. (mm)	Length (mm)	Ripple Current (100 kHz) (+105 °C) (mA r.m.s.)	Impedance (100 kHz) (+20 °C) (Ω)	Endurance (hours)	Lead Dia. (mm)	Lead Space			Straight Leads (pcs)	Taping (pcs)
								Straight (mm)	Taping *B (mm)			
16	390	8	11.5	630	0.090	3000	0.6	3.5	5.0	EEUFK1C391()	200	1000
	680	8	15	860	0.062	3000	0.6	3.5	5.0	EEUFK1C681L()	200	1000
		10	12.5	900	0.063	4000	0.6	5.0	5.0	EEUFK1C681()	200	500
	820	8	20	1220	0.044	3000	0.6	3.5	5.0	EEUFK1C821L()	200	1000
	1000	10	16	1240	0.049	4000	0.6	5.0	5.0	EEUFK1C102()	200	500
	1200	10	20	1490	0.035	4000	0.6	5.0	5.0	EEUFK1C122()	200	500
		12.5	15	1400	0.048	5000	0.6	5.0	5.0	EEUFK1C122S()	200	500
	1500	10	25	1680	0.033	4000	0.6	5.0	5.0	EEUFK1C152L()	200	500
	2200	10	30	2140	0.025	4000	0.6	5.0		EEUFK1C222L	100	
		12.5	20	1890	0.029	5000	0.6	5.0	5.0	EEUFK1C222()	200	500
		16	15	1800	0.038	5000	0.8	7.5	7.5	EEUFK1C222S()	100	250
	2700	12.5	25	2280	0.022	5000	0.6	5.0	5.0	EEUFK1C272()	200	500
		18	15	2060	0.036	5000	0.8	7.5	7.5	EEUFK1C272S()	100	250
	3300	12.5	30	2720	0.018	5000	0.8	5.0		EEUFK1C332L	100	
	3900	12.5	35	2940	0.016	5000	0.8	5.0		EEUFK1C392L	100	
		16	20	2330	0.026	5000	0.8	7.5	7.5	EEUFK1C392S()	100	250
	4700	12.5	40	3010	0.014	5000	0.8	5.0		EEUFK1C472L	100	
		18	20	2640	0.025	5000	0.8	7.5	7.5	EEUFK1C472S()	100	250
5600	16	25	2760	0.019	5000	0.8	7.5	7.5	EEUFK1C562()	100	250	
6800	18	25	2850	0.018	5000	0.8	7.5	7.5	EEUFK1C682S()	100	250	
25	270	8	11.5	630	0.090	3000	0.6	3.5	5.0	EEUFK1E271()	200	1000
	390	8	15	860	0.062	3000	0.6	3.5	5.0	EEUFK1E391L()	200	1000
	470	10	12.5	900	0.063	4000	0.6	5.0	5.0	EEUFK1E471()	200	500
	560	8	20	1220	0.044	3000	0.6	3.5	5.0	EEUFK1E561L()	200	1000
		10	16	1240	0.049	4000	0.6	5.0	5.0	EEUFK1E561()	200	500
	820	10	20	1490	0.035	4000	0.6	5.0	5.0	EEUFK1E821()	200	500
		12.5	15	1400	0.048	5000	0.6	5.0	5.0	EEUFK1E821S()	200	500
	1000	10	25	1680	0.033	4000	0.6	5.0	5.0	EEUFK1E102L()	200	500
	1200	12.5	20	1890	0.029	5000	0.6	5.0	5.0	EEUFK1E122()	200	500
	1500	10	30	2140	0.025	4000	0.6	5.0		EEUFK1E152L	100	
		16	15	1800	0.038	5000	0.8	7.5	7.5	EEUFK1E152S()	100	250
	1800	12.5	25	2280	0.022	5000	0.6	5.0	5.0	EEUFK1E182()	200	500
		18	15	2060	0.036	5000	0.8	7.5	7.5	EEUFK1E182S()	100	250
	2200	12.5	30	2720	0.018	5000	0.8	5.0		EEUFK1E222L	100	
		16	20	2330	0.026	5000	0.8	7.5	7.5	EEUFK1E222S()	100	250
	2700	12.5	35	2940	0.016	5000	0.8	5.0		EEUFK1E272L	100	
	3300	12.5	40	3010	0.014	5000	0.8	5.0		EEUFK1E332L	100	
		16	25	2760	0.019	5000	0.8	7.5	7.5	EEUFK1E332()	100	250
18		20	2640	0.025	5000	0.8	7.5	7.5	EEUFK1E332S()	100	250	
4700	18	25	2850	0.018	5000	0.8	7.5	7.5	EEUFK1E472S()	100	250	

- When requesting taped product, please put the letter "B" between the "()". Lead wire pitch *B=5 mm, 7.5 mm.
- Please refer to the page of "Taping Dimensions".

■ Standard Products

Endurance : 105 °C ϕ 8=3000 h, ϕ 10=4000 h, ϕ 12.5 to ϕ 18=5000 h

W.V. (V)	Cap. (\pm 20 %) (μ F)	Case size		Specification			Lead Length			Part No.	Min. Packaging Q'ty	
		Dia. (mm)	Length (mm)	Ripple Current (100 kHz) (+105 °C) (mA r.m.s.)	Impedance (100 kHz) (+20 °C) (Ω)	Endurance (hours)	Lead Dia. (mm)	Lead Space			Straight Leads (pcs)	Taping (pcs)
								Straight (mm)	Taping *B (mm)			
35	180	8	11.5	630	0.090	3000	0.6	3.5	5.0	EEUFK1V181()	200	1000
	270	8	15	860	0.062	3000	0.6	3.5	5.0	EEUFK1V271L()	200	1000
		10	12.5	900	0.063	4000	0.6	5.0	5.0	EEUFK1V271()	200	500
	390	8	20	1220	0.044	3000	0.6	3.5	5.0	EEUFK1V391L()	200	1000
		10	16	1240	0.049	4000	0.6	5.0	5.0	EEUFK1V391()	200	500
	560	10	20	1490	0.035	4000	0.6	5.0	5.0	EEUFK1V561()	200	500
		12.5	15	1400	0.048	5000	0.6	5.0	5.0	EEUFK1V561S()	200	500
	680	10	25	1680	0.033	4000	0.6	5.0	5.0	EEUFK1V681L()	200	500
	820	12.5	20	1890	0.029	5000	0.6	5.0	5.0	EEUFK1V821()	200	500
	1000	10	30	2140	0.025	4000	0.6	5.0		EEUFK1V102L	100	
		16	15	1800	0.038	5000	0.8	7.5	7.5	EEUFK1V102S()	100	250
	1200	12.5	25	2280	0.022	5000	0.6	5.0	5.0	EEUFK1V122()	200	500
		18	15	2060	0.036	5000	0.8	7.5	7.5	EEUFK1V122S()	100	250
	1500	12.5	30	2720	0.018	5000	0.8	5.0		EEUFK1V152L	100	
	1800	12.5	35	2940	0.016	5000	0.8	5.0		EEUFK1V182L	100	
		16	20	2330	0.026	5000	0.8	7.5	7.5	EEUFK1V182S()	100	250
	2200	12.5	40	3010	0.014	5000	0.8	5.0		EEUFK1V222L	100	
		16	25	2760	0.019	5000	0.8	7.5	7.5	EEUFK1V222()	100	250
		18	20	2640	0.025	5000	0.8	7.5	7.5	EEUFK1V222S()	100	250
	3300	18	25	2850	0.018	5000	0.8	7.5	7.5	EEUFK1V332S()	100	250

- When requesting taped product, please put the letter "B" between the "()". Lead wire pitch *B=5 mm, 7.5 mm.
- Please refer to the page of "Taping Dimensions".

Radial Lead Type

Series: **FM** Type: **A**

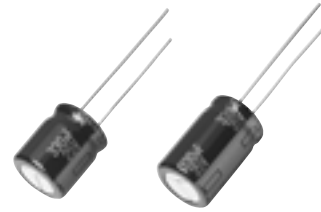

■ Features

- Low impedance (40 % to 70 % less than FC Series)
- Endurance : 2000 h to 7000 h at +105 °C
- RoHS directive compliant

■ Attention

Not applicable for automotive

■ Specifications

Category Temp. Range	-40 °C to +105 °C							
Rated W.V. Range	6.3 V.DC to 50 V.DC							
Nominal Cap. Range	22 μF to 6800 μF							
Capacitance Tolerance	±20 % (120 Hz/+20 °C)							
DC Leakage Current	I ≤ 0.01 CV (μA) After 2 minutes							
tan δ	W.V.	6.3	10	16	25	35	50	(max.) (120 Hz/+20 °C)
	tan δ	0.22	0.19	0.16	0.14	0.12	0.10	
Add 0.02 per 1000 μF for products of 1000 μF or more.								
Endurance	After following life test with DC voltage and +105 °C±2 °C ripple current value applied. (The sum of DC and ripple peak voltage shall not exceed the rated working voltage) when the capacitors are restored to 20 °C, the capacitors shall meet the limits specified below.							
	Duration							
	φ5 to φ6.3 : 2000 hours, φ8×11.5 to φ8×15: 3000 hours φ8×20 to φ10×16 : 4000 hours, φ10×20 to φ12.5×20/ φ16×20: 5000 hours φ12.5×25 to φ12.5×35/ φ16×25 : 7000 hours							
	Capacitance change	±25 % of initial measured value (6.3 V to 10 V : ±30 %)						
	tan δ	≤ 200 % of initial specified value						
	DC leakage current	≤ initial specified value						
Shelf Life	After storage for 1000 hours at +105 °C±2 °C with no voltage applied and then being stabilized at +20 °C, capacitors shall meet the limits specified in Endurance. (With voltage treatment)							

■ Frequency correction factor for ripple current

W.V.(V.DC)	Cap (μF)	Frequency (Hz)				
		60	120	1 k	10 k	100 k
6.3 to 50	22 to 33	0.45	0.55	0.75	0.90	1.00
	47 to 330	0.60	0.70	0.85	0.95	1.00
	390 to 1000	0.65	0.75	0.90	0.98	1.00
	1200 to 6800	0.75	0.80	0.95	1.00	1.00

■ Dimensions in mm (not to scale)

(Unit : mm)

Body Dia. φD	5	6.3	8	10	12.5	16
Body Length L	—	—	—	—	12.5 to 25	30 to 40
Lead Dia. φd	0.5	0.5	0.6	0.6	0.6	0.8
Lead space F	2.0	2.5	3.5	5.0	5.0	7.5

Design and specifications are each subject to change without notice. Ask factory for the current technical specifications before purchase and/or use. Should a safety concern arise regarding this product, please be sure to contact us immediately.

01 May, 2014

■ Case size/Impedance/Ripple current

W.V.(V.DC) Case size (ϕ D×L)	6.3 V to 35 V			50 V		
	Impedance (Ω /100 kHz)		Ripple Current (mA r.m.s./100 kHz)	Impedance (Ω /100 kHz)		Ripple Current (mA r.m.s./100 kHz)
	+20 °C	-10 °C	+105 °C	+20 °C	-10 °C	+105 °C
5 × 11	0.300	1.000	280	0.340	1.130	250
6.3 × 11.2	0.130	0.430	455	0.140	0.460	405
8 × 11.5	0.056	0.168	950	0.061	0.183	870
8 × 15	0.041	0.123	1240	0.045	0.135	1140
8 × 20	0.030	0.090	1560	0.033	0.099	1430
10 × 12.5	0.038	0.114	1290	0.042	0.126	1170
10 × 16	0.026	0.078	1790	0.030	0.090	1650
10 × 20	0.019	0.057	2180	0.023	0.069	1890
10 × 25	0.018	0.054	2470	0.022	0.066	2150
12.5 × 20	0.018	0.045	2600	0.022	0.055	2260
12.5 × 25	0.015	0.038	3190	0.018	0.045	2660
12.5 × 30	0.013	0.033	3630	0.016	0.040	3160
12.5 × 35	0.012	0.030	3750	0.014	0.035	3270
16 × 20	0.017	0.043	3300	0.019	0.048	2870
16 × 25	0.014	0.035	3820	0.016	0.040	3320

Standard Products

W.V. (V)	Cap. (±20 %) (μF)	Case size		Specification			Lead Length				Part No.	Min. Packaging Qty	
		Dia. (mm)	Length (mm)	Ripple Current (100 kHz) (+105 °C) (mA r.m.s.)	Impedance (100 kHz) (+20 °C) (Ω)	Endurance (hours)	Lead Dia. (mm)	Lead Space				Long Lead (pcs)	Taping (pcs)
								Straight (mm)	Taping *B (mm)	Taping *H (mm)			
6.3	150	5	11	280	0.300	2000	0.5	2.0	5.0	2.5	EEUFM0J151()	200	2000
	330	6.3	11.2	455	0.130	2000	0.5	2.5	5.0	2.5	EEUFM0J331()	200	2000
	560	8	11.5	950	0.056	3000	0.6	3.5	5.0		EEUFM0J561()	200	1000
	820	8	15	1240	0.041	3000	0.6	3.5	5.0		EEUFM0J821L()	200	1000
	1000	10	12.5	1290	0.038	4000	0.6	5.0	5.0		EEUFM0J102()	200	500
	1200	8	20	1560	0.030	4000	0.6	3.5	5.0		EEUFM0J122L()	200	1000
		10	16	1790	0.026	4000	0.6	5.0	5.0		EEUFM0J122()	200	500
	1500	10	20	2180	0.019	5000	0.6	5.0	5.0		EEUFM0J152()	200	500
	2200	10	25	2470	0.018	5000	0.6	5.0	5.0		EEUFM0J222L()	200	500
	3300	12.5	20	2600	0.018	5000	0.6	5.0	5.0		EEUFM0J332()	200	500
	3900	12.5	25	3190	0.015	7000	0.6	5.0	5.0		EEUFM0J392()	200	500
	4700	12.5	30	3630	0.013	7000	0.8	5.0			EEUFM0J472L	100	
	5600	12.5	35	3750	0.012	7000	0.8	5.0			EEUFM0J562L	100	
		16	20	3300	0.017	5000	0.8	7.5	7.5		EEUFM0J562S()	100	250
6800	16	25	3820	0.014	7000	0.8	7.5	7.5		EEUFM0J682()	100	250	
10	100	5	11	280	0.300	2000	0.5	2.0	5.0	2.5	EEUFM1A101()	200	2000
	220	6.3	11.2	455	0.130	2000	0.5	2.5	5.0	2.5	EEUFM1A221()	200	2000
	470	8	11.5	950	0.056	3000	0.6	3.5	5.0		EEUFM1A471()	200	1000
	680	8	15	1240	0.041	3000	0.6	3.5	5.0		EEUFM1A681L()	200	1000
		10	12.5	1290	0.038	4000	0.6	5.0	5.0		EEUFM1A681()	200	500
	1000	8	20	1560	0.030	4000	0.6	3.5	5.0		EEUFM1A102L()	200	1000
		10	16	1790	0.026	4000	0.6	5.0	5.0		EEUFM1A102()	200	500
	1200	10	20	2180	0.019	5000	0.6	5.0	5.0		EEUFM1A122()	200	500
	1500	10	25	2470	0.018	5000	0.6	5.0	5.0		EEUFM1A152L()	200	500
	2200	12.5	20	2600	0.018	5000	0.6	5.0	5.0		EEUFM1A222()	200	500
	3300	12.5	25	3190	0.015	7000	0.6	5.0	5.0		EEUFM1A332()	200	500
	3900	12.5	30	3630	0.013	7000	0.8	5.0			EEUFM1A392L	100	
		16	20	3300	0.017	5000	0.8	7.5	7.5		EEUFM1A392S()	100	250
	4700	12.5	35	3750	0.012	7000	0.8	5.0			EEUFM1A472L	100	
5600	16	25	3820	0.014	7000	0.8	7.5	7.5		EEUFM1A562()	100	250	
16	68	5	11	280	0.300	2000	0.5	2.0	5.0	2.5	EEUFM1C680()	200	2000
	120	6.3	11.2	455	0.130	2000	0.5	2.5	5.0	2.5	EEUFM1C121()	200	2000
	330	8	11.5	950	0.056	3000	0.6	3.5	5.0		EEUFM1C331()	200	1000
	470	8	15	1240	0.041	3000	0.6	3.5	5.0		EEUFM1C471L()	200	1000
		10	12.5	1290	0.038	4000	0.6	5.0	5.0		EEUFM1C471()	200	500
	680	8	20	1560	0.030	4000	0.6	3.5	5.0		EEUFM1C681L()	200	1000
		10	16	1790	0.026	4000	0.6	5.0	5.0		EEUFM1C681()	200	500
	1000	10	20	2180	0.019	5000	0.6	5.0	5.0		EEUFM1C102()	200	500
	1200	10	25	2470	0.018	5000	0.6	5.0	5.0		EEUFM1C122L()	200	500
	1500	12.5	20	2600	0.018	5000	0.6	5.0	5.0		EEUFM1C152()	200	500
	2200	12.5	25	3190	0.015	7000	0.6	5.0	5.0		EEUFM1C222()	200	500
	2700	12.5	30	3630	0.013	7000	0.8	5.0			EEUFM1C272L	100	
		16	20	3300	0.017	5000	0.8	7.5	7.5		EEUFM1C272S()	100	250
	3300	12.5	35	3750	0.012	7000	0.8	5.0			EEUFM1C332L	100	
3900	16	25	3820	0.014	7000	0.8	7.5	7.5		EEUFM1C392()	100	250	

· When requesting taped product, please put the letter "B" or "H" between the "()". Lead wire pitch *B=5 mm, 7.5 mm, H=2.5 mm.
 · Please refer to the page of "Taping Dimensions".

Design and specifications are each subject to change without notice. Ask factory for the current technical specifications before purchase and/or use.
 Should a safety concern arise regarding this product, please be sure to contact us immediately.

01 May, 2014

Standard Products

W.V. (V)	Cap. (±20 %) (μF)	Case size		Specification			Lead Length				Part No.	Min. Packaging Qty	
		Dia. (mm)	Length (mm)	Ripple Current (100 kHz) (+105 °C) (mA r.m.s.)	Impedance (100 kHz) (+20 °C) (Ω)	Endurance (hours)	Lead Dia. (mm)	Lead Space				Long Lead (pcs)	Taping (pcs)
								Straight (mm)	Taping *B (mm)	Taping *H (mm)			
25	47	5	11	280	0.300	2000	0.5	2.0	5.0	2.5	EEUFM1E470()	200	2000
	100	6.3	11.2	455	0.130	2000	0.5	2.5	5.0	2.5	EEUFM1E101()	200	2000
	220	8	11.5	950	0.056	3000	0.6	3.5	5.0		EEUFM1E221()	200	1000
	330	8	15	1240	0.041	3000	0.6	3.5	5.0		EEUFM1E331L()	200	1000
		10	12.5	1290	0.038	4000	0.6	5.0	5.0		EEUFM1E331()	200	500
	470	8	20	1560	0.030	4000	0.6	3.5	5.0		EEUFM1E471L()	200	1000
		10	16	1790	0.026	4000	0.6	5.0	5.0		EEUFM1E471()	200	500
	680	10	20	2180	0.019	5000	0.6	5.0	5.0		EEUFM1E681()	200	500
	820	10	25	2470	0.018	5000	0.6	5.0	5.0		EEUFM1E821L()	200	500
	1000	12.5	20	2600	0.018	5000	0.6	5.0	5.0		EEUFM1E102()	200	500
	1500	12.5	25	3190	0.015	7000	0.6	5.0	5.0		EEUFM1E152()	200	500
	1800	12.5	30	3630	0.013	7000	0.8	5.0			EEUFM1E182L	100	
		16	20	3300	0.017	5000	0.8	7.5	7.5		EEUFM1E182S()	100	250
2200	12.5	35	3750	0.012	7000	0.8	5.0			EEUFM1E222L	100		
2700	16	25	3820	0.014	7000	0.8	7.5	7.5		EEUFM1E272()	100	250	
35	33	5	11	280	0.300	2000	0.5	2.0	5.0	2.5	EEUFM1V330()	200	2000
	68	6.3	11.2	455	0.130	2000	0.5	2.5	5.0	2.5	EEUFM1V680()	200	2000
	150	8	11.5	950	0.056	3000	0.6	3.5	5.0		EEUFM1V151()	200	1000
	220	8	15	1240	0.041	3000	0.6	3.5	5.0		EEUFM1V221L()	200	1000
		10	12.5	1290	0.038	4000	0.6	5.0	5.0		EEUFM1V221()	200	500
	330	8	20	1560	0.030	4000	0.6	3.5	5.0		EEUFM1V331L()	200	1000
		10	16	1790	0.026	4000	0.6	5.0	5.0		EEUFM1V331()	200	500
	470	10	20	2180	0.019	5000	0.6	5.0	5.0		EEUFM1V471()	200	500
	560	10	25	2470	0.018	5000	0.6	5.0	5.0		EEUFM1V561L()	200	500
	680	12.5	20	2600	0.018	5000	0.6	5.0	5.0		EEUFM1V681()	200	500
	1000	12.5	25	3190	0.015	7000	0.6	5.0	5.0		EEUFM1V102()	200	500
	1200	12.5	30	3630	0.013	7000	0.8	5.0			EEUFM1V122L	100	
		16	20	3300	0.017	5000	0.8	7.5	7.5		EEUFM1V122S()	100	250
1500	12.5	35	3750	0.012	7000	0.8	5.0			EEUFM1V152L	100		
1800	16	25	3820	0.014	7000	0.8	7.5	7.5		EEUFM1V182()	100	250	
50	22	5	11	250	0.340	2000	0.5	2.0	5.0	2.5	EEUFM1H220()	200	2000
	56	6.3	11.2	405	0.140	2000	0.5	2.5	5.0	2.5	EEUFM1H560()	200	2000
	100	8	11.5	870	0.061	3000	0.6	3.5	5.0		EEUFM1H101()	200	1000
	120	8	15	1140	0.045	3000	0.6	3.5	5.0		EEUFM1H121L()	200	1000
	150	10	12.5	1170	0.042	4000	0.6	5.0	5.0		EEUFM1H151()	200	500
	180	8	20	1430	0.033	4000	0.6	3.5	5.0		EEUFM1H181L()	200	1000
	220	10	16	1650	0.030	4000	0.6	5.0	5.0		EEUFM1H221()	200	500
	270	10	20	1890	0.023	5000	0.6	5.0	5.0		EEUFM1H271()	200	500
	330	10	25	2150	0.022	5000	0.6	5.0	5.0		EEUFM1H331L()	200	500
	470	12.5	20	2260	0.022	5000	0.6	5.0	5.0		EEUFM1H471()	200	500
	560	12.5	25	2660	0.018	7000	0.6	5.0	5.0		EEUFM1H561()	200	500
	680	12.5	30	3160	0.016	7000	0.8	5.0			EEUFM1H681L	100	
	820	12.5	35	3270	0.014	7000	0.8	5.0			EEUFM1H821L	100	
16		20	2870	0.019	5000	0.8	7.5	7.5		EEUFM1H821S()	100	250	
1000	16	25	3320	0.016	7000	0.8	7.5	7.5		EEUFM1H102()	100	250	

· When requesting taped product, please put the letter "B" or "H" between the "()". Lead wire pitch *B=5 mm, 7.5 mm, H=2.5 mm.
 · Please refer to the page of "Taping Dimensions".

Design and specifications are each subject to change without notice. Ask factory for the current technical specifications before purchase and/or use.
 Should a safety concern arise regarding this product, please be sure to contact us immediately.

01 May, 2014

Radial Lead Type

Series: **FR** Type: **A**

■ Features

- Low ESR (Same as FM Series)
- Endurance : 5000 h to 10000 h at +105 °C
- RoHS directive compliant

■ Country of origin

Malaysia



■ Attention

Not applicable for automotive

■ Specifications

Category Temp. Range	-40 °C to +105 °C									
Rated W.V. Range	6.3 V.DC to 100 V.DC									
Nominal Cap. Range	4.7 μF to 8200 μF									
Capacitance Tolerance	±20 % (120 Hz/+20 °C)									
DC Leakage Current	I ≤ 0.01 CV (μA) After 2 minutes									
tan δ	W.V.	6.3	10	16	25	35	50	63	100	(120 Hz/+20 °C)
	tan δ	0.22	0.19	0.16	0.14	0.12	0.10	0.09	0.08	
Add 0.02 per 1000 μF for products of 1000 μF or more.										
Endurance	After following life test with DC voltage and +105 °C±2 °C ripple current value applied. (The sum of DC and ripple peak voltage shall not exceed the rated working voltage) when the capacitors are restored to 20 °C, the capacitors shall meet the limits specified below.									
	Duration									
	φ5×11/ φ6.3×11.2 : 5000 hours									
	φ8×11.5/ φ10×12.5 : 6000 hours (* Only EEUFR1V331U (φ10×12.5) 5000 hours)									
	φ8×15/ φ10×16 : 8000 hours, φ8×20 : 9000 hours φ10×20 to φ10×25/ φ12.5×20 to φ12.5×35/ φ16×20 to φ16×25 : 10000 hours									
Capacitance change	±25 % of initial measured value (6.3 V to 10 V : ±30 %)									
tan δ	≤ 200 % of initial specified value									
DC leakage current	≤ initial specified value									
Shelf Life	After storage for 1000 hours at +105 °C±2 °C with no voltage applied and then being stabilized at +20 °C, capacitors shall meet the limits specified in Endurance. (With voltage treatment)									

■ Frequency correction factor for ripple current

W.V.(V.DC)	Cap (μF)	Frequency (Hz)				
		60	120	1 k	10 k	100 k
6.3 to 100	4.7 to 33	0.45	0.55	0.75	0.90	1.00
	47 to 330	0.60	0.70	0.85	0.95	1.00
	390 to 1000	0.65	0.75	0.90	0.98	1.00
	1200 to 8200	0.75	0.80	0.95	1.00	1.00

■ Dimensions in mm (not to scale)

(Unit : mm)

Body Dia. φD	5	6.3	8	10	12.5	16
Body Length L	—	—	—	—	12.5 to 25	30 to 35
Lead Dia. φd	0.5	0.5	0.6	0.6	0.6	0.8
Lead space F	2.0	2.5	3.5	5.0	5.0	7.5

Design and specifications are each subject to change without notice. Ask factory for the current technical specifications before purchase and/or use. Should a safety concern arise regarding this product, please be sure to contact us immediately.

06 Nov. 2014

■ Case size/Impedance/Ripple current

W.V.(V.DC) Case size (ϕ D×L)	6.3 V to 35 V			50 V		
	Impedance (Ω /100 kHz)		Ripple Current (mA r.m.s./100 kHz)	Impedance (Ω /100 kHz)		Ripple Current (mA r.m.s./100 kHz)
	+20 °C	-10 °C	+105 °C	+20 °C	-10 °C	+105 °C
5 × 11	0.300	1.000	280	0.340	1.130	250
6.3 × 11.2	0.130	0.430	455	0.140	0.460	405
8 × 11.5	0.056	0.168	950	0.061	0.183	870
8 × 15	0.041	0.123	1240	0.045	0.135	1140
8 × 20	0.030	0.090	1560	0.033	0.099	1430
10 × 12.5	0.043	0.114	1290	0.042	0.126	1170
10 × 16	0.028	0.078	1790	0.030	0.090	1650
10 × 20	0.020	0.057	2180	0.023	0.069	1890
10 × 25	0.018	0.054	2470	0.022	0.066	2150
12.5 × 20	0.018	0.045	2600	0.022	0.055	2260
12.5 × 25	0.015	0.038	3190	0.018	0.045	2660
12.5 × 30	0.013	0.033	3630	0.016	0.040	3160
12.5 × 35	0.012	0.030	3750	0.014	0.035	3270
16 × 20	0.017	0.043	3300	0.019	0.048	2870
16 × 25	0.014	0.035	3820	0.016	0.040	3320

W.V.(V.DC) Case size (ϕ D×L)	63 V		
	Impedance (Ω /100 kHz)		Ripple Current (mA r.m.s./100 kHz)
	+20 °C	-10 °C	+105 °C
5 × 11	0.510	2.040	175
6.3 × 11.2	0.210	0.840	284
8 × 11.5	0.092	0.368	566
8 × 15	0.068	0.272	741
8 × 20	0.050	0.200	930
10 × 12.5	0.063	0.252	761
10 × 16	0.045	0.180	1073
10 × 20	0.035	0.140	1229
10 × 25	0.033	0.132	1500
12.5 × 20	0.033	0.125	1582
12.5 × 25	0.027	0.092	1995
12.5 × 30	0.024	0.082	2528
12.5 × 35	0.021	0.071	2780
16 × 20	0.029	0.093	2153
16 × 25	0.024	0.074	2988

W.V.(V.DC) Case size (ϕ D×L)	100 V		
	Impedance (Ω /100 kHz)		Ripple Current (mA r.m.s./100 kHz)
	+20 °C	-10 °C	+105 °C
10 × 20	0.084	0.336	1500

Design and specifications are each subject to change without notice. Ask factory for the current technical specifications before purchase and/or use.
Should a safety concern arise regarding this product, please be sure to contact us immediately.

Standard Products

W.V. (V)	Cap. (±20 %) (μF)	Case size		Specification			Lead Length			Part No.	Min. Packaging Qty		
		Dia. (mm)	Length (mm)	Ripple Current (100 kHz) (+105 °C) (mA r.m.s.)	Impedance (100 kHz) (+20 °C) (Ω)	Endurance (hours)	Lead Dia. (mm)	Lead Space			Straight Leads (pcs)	Taping (pcs)	
								Straight (mm)	Taping *B (mm)				Taping *H (mm)
6.3	150	5	11	280	0.300	5000	0.5	2.0	5.0	2.5	EEUFR0J151()	200	2000
	220	6.3	11.2	455	0.130	5000	0.5	2.5	5.0	2.5	EEUFR0J221()	200	2000
	330	6.3	11.2	455	0.130	5000	0.5	2.5	5.0	2.5	EEUFR0J331()	200	2000
	470	6.3	11.2	455	0.130	5000	0.5	2.5	5.0	2.5	EEUFR0J471()	200	2000
	820	8	11.5	950	0.056	6000	0.6	3.5	5.0		EEUFR0J821()	200	1000
	1000	8	11.5	950	0.056	6000	0.6	3.5	5.0		EEUFR0J102()	200	1000
	1200	8	15	1240	0.041	8000	0.6	3.5	5.0		EEUFR0J122L()	200	1000
		10	12.5	1290	0.043	6000	0.6	5.0	5.0		EEUFR0J122()	200	500
	1500	8	20	1560	0.030	9000	0.6	3.5	5.0		EEUFR0J152L()	200	1000
	1800	10	16	1790	0.028	8000	0.6	5.0	5.0		EEUFR0J182()	200	500
	2200	10	20	2180	0.020	10000	0.6	5.0	5.0		EEUFR0J222()	200	500
	2700	10	25	2470	0.018	10000	0.6	5.0	5.0		EEUFR0J272L()	200	500
	3300	10	25	2470	0.018	10000	0.6	5.0	5.0		EEUFR0J332L()	200	500
	3900	12.5	20	2600	0.018	10000	0.6	5.0	5.0		EEUFR0J392()	200	500
	4700	12.5	25	3190	0.015	10000	0.6	5.0	5.0		EEUFR0J472()	200	500
	5600	12.5	30	3630	0.013	10000	0.8	5.0			EEUFR0J562L	100	
	6800	12.5	35	3750	0.012	10000	0.8	5.0			EEUFR0J682L	100	
		16	20	3300	0.017	10000	0.8	7.5	7.5		EEUFR0J682S()	100	250
8200	16	25	3820	0.014	10000	0.8	7.5	7.5		EEUFR0J822()	100	250	
10	100	5	11	280	0.300	5000	0.5	2.0	5.0	2.5	EEUFR1A101()	200	2000
	150	5	11	280	0.300	5000	0.5	2.0	5.0	2.5	EEUFR1A151()	200	2000
	220	6.3	11.2	455	0.130	5000	0.5	2.5	5.0	2.5	EEUFR1A221()	200	2000
	270	6.3	11.2	455	0.130	5000	0.5	2.5	5.0	2.5	EEUFR1A271()	200	2000
	470	8	11.5	950	0.056	6000	0.6	3.5	5.0		EEUFR1A471()	200	1000
	680	8	11.5	950	0.056	6000	0.6	3.5	5.0		EEUFR1A681()	200	1000
	820	10	12.5	1290	0.043	6000	0.6	5.0	5.0		EEUFR1A821()	200	500
	1000	10	16	1790	0.028	8000	0.6	5.0	5.0		EEUFR1A102()	200	500
		8	15	1240	0.041	8000	0.6	3.5	5.0		EEUFR1A102L()	200	1000
	1500	8	20	1560	0.030	9000	0.6	3.5	5.0		EEUFR1A152L()	200	1000
		10	16	1790	0.028	8000	0.6	5.0	5.0		EEUFR1A152()	200	500
	1800	10	20	2180	0.020	10000	0.6	5.0	5.0		EEUFR1A182()	200	500
	2200	10	25	2470	0.018	10000	0.6	5.0	5.0		EEUFR1A222L()	200	500
	3300	12.5	20	2600	0.018	10000	0.6	5.0	5.0		EEUFR1A332()	200	500
	3900	12.5	25	3190	0.015	10000	0.6	5.0	5.0		EEUFR1A392()	200	500
	4700	12.5	30	3630	0.013	10000	0.8	5.0			EEUFR1A472L	100	
		16	20	3300	0.017	10000	0.8	7.5	7.5		EEUFR1A472S()	100	250
	5600	12.5	35	3750	0.012	10000	0.8	5.0			EEUFR1A562L	100	
6800	12.5	35	3750	0.012	10000	0.8	5.0			EEUFR1A682L	100		
	16	25	3820	0.014	10000	0.8	7.5	7.5		EEUFR1A682()	100	250	

· When requesting taped product, please put the letter "B" or "H" between the "()". Lead wire pitch *B=5 mm, 7.5 mm, H=2.5 mm.
 · Please refer to the page of "Taping Dimensions".

Standard Products

W.V. (V)	Cap. (±20 %) (μF)	Case size		Specification			Lead Length			Part No.	Min. Packaging Q'ty		
		Dia. (mm)	Length (mm)	Ripple Current (100 kHz) (+105 °C) (mA r.m.s.)	Impedance (100 kHz) (+20 °C) (Ω)	Endurance (hours)	Lead Dia. (mm)	Lead Space			Straight Leads (pcs)	Taping (pcs)	
								Straight (mm)	Taping *B (mm)				Taping *H (mm)
16	68	5	11	280	0.300	5000	0.5	2.0	5.0	2.5	EEUFR1C680()	200	2000
	100	5	11	280	0.300	5000	0.5	2.0	5.0	2.5	EEUFR1C101()	200	2000
	120	6.3	11.2	455	0.130	5000	0.5	2.5	5.0	2.5	EEUFR1C121()	200	2000
	220	6.3	11.2	455	0.130	5000	0.5	2.5	5.0	2.5	EEUFR1C221()	200	2000
	470	8	11.5	950	0.056	6000	0.6	3.5	5.0		EEUFR1C471()	200	1000
	680	8	15	1240	0.041	8000	0.6	3.5	5.0		EEUFR1C681L()	200	1000
		10	12.5	1290	0.043	6000	0.6	5.0	5.0		EEUFR1C681()	200	500
	1000	8	20	1560	0.030	9000	0.6	3.5	5.0		EEUFR1C102L()	200	1000
		10	16	1790	0.028	8000	0.6	5.0	5.0		EEUFR1C102()	200	500
	1500	10	20	2180	0.020	10000	0.6	5.0	5.0		EEUFR1C152()	200	500
		10	25	2470	0.018	10000	0.6	5.0	5.0		EEUFR1C152L()	200	500
	1800	10	25	2470	0.018	10000	0.6	5.0	5.0		EEUFR1C182L()	200	500
	2200	12.5	20	2600	0.018	10000	0.6	5.0	5.0		EEUFR1C222()	200	500
	2700	12.5	25	3190	0.015	10000	0.6	5.0	5.0		EEUFR1C272()	200	500
	3300	12.5	30	3630	0.013	10000	0.8	5.0			EEUFR1C332L	100	
		16	20	3300	0.017	10000	0.8	7.5	7.5		EEUFR1C332S()	100	250
	3900	12.5	35	3750	0.012	10000	0.8	5.0			EEUFR1C392L	100	
		16	20	3300	0.017	10000	0.8	7.5	7.5		EEUFR1C392S()	100	250
	4700	12.5	35	3750	0.012	10000	0.8	5.0			EEUFR1C472L	100	
		16	25	3820	0.014	10000	0.8	7.5	7.5		EEUFR1C472()	100	250
5600	16	25	3820	0.014	10000	0.8	7.5	7.5		EEUFR1C562()	100	250	
25	47	5	11	280	0.300	5000	0.5	2.0	5.0	2.5	EEUFR1E470()	200	2000
	68	5	11	280	0.300	5000	0.5	2.0	5.0	2.5	EEUFR1E680()	200	2000
	100	6.3	11.2	455	0.130	5000	0.5	2.5	5.0	2.5	EEUFR1E101()	200	2000
	150	6.3	11.2	455	0.130	5000	0.5	2.5	5.0	2.5	EEUFR1E151()	200	2000
	220	8	11.5	950	0.056	6000	0.6	3.5	5.0		EEUFR1E221()	200	1000
	330	8	11.5	950	0.056	6000	0.6	3.5	5.0		EEUFR1E331()	200	1000
	390	8	15	1240	0.041	8000	0.6	3.5	5.0		EEUFR1E391L()	200	1000
	470	8	15	1240	0.041	8000	0.6	3.5	5.0		EEUFR1E471Y()	200	1000
		8	20	1560	0.030	9000	0.6	3.5	5.0		EEUFR1E471L()	200	1000
		10	12.5	1290	0.043	6000	0.6	5.0	5.0		EEUFR1E471()	200	500
	560	8	20	1560	0.030	9000	0.6	3.5	5.0		EEUFR1E561L()	200	1000
	680	8	20	1560	0.030	9000	0.6	3.5	5.0		EEUFR1E681L()	200	1000
		10	16	1790	0.028	8000	0.6	5.0	5.0		EEUFR1E681()	200	500
	820	10	20	2180	0.020	10000	0.6	5.0	5.0		EEUFR1E821()	200	500
	1000	10	20	2180	0.020	10000	0.6	5.0	5.0		EEUFR1E102()	200	500
		10	25	2470	0.018	10000	0.6	5.0	5.0		EEUFR1E102L()	200	500
	1200	10	25	2470	0.018	10000	0.6	5.0	5.0		EEUFR1E122L()	200	500
	1500	12.5	20	2600	0.018	10000	0.6	5.0	5.0		EEUFR1E152()	200	500
	1800	12.5	25	3190	0.015	10000	0.6	5.0	5.0		EEUFR1E182()	200	500
		16	20	3300	0.017	10000	0.8	7.5	7.5		EEUFR1E182S()	100	250
2200	12.5	30	3630	0.013	10000	0.8	5.0			EEUFR1E222L	100		
	16	20	3300	0.017	10000	0.8	7.5	7.5		EEUFR1E222S()	100	250	
2700	12.5	35	3750	0.012	10000	0.8	5.0			EEUFR1E272L	100		
	16	20	3300	0.017	10000	0.8	7.5	7.5		EEUFR1E272S()	100	250	
3300	16	25	3820	0.014	10000	0.8	7.5	7.5		EEUFR1E332()	100	250	

· When requesting taped product, please put the letter "B" or "H" between the "()". Lead wire pitch *B=5 mm, 7.5 mm, H=2.5 mm.
 · Please refer to the page of "Taping Dimensions".

Design and specifications are each subject to change without notice. Ask factory for the current technical specifications before purchase and/or use.
 Should a safety concern arise regarding this product, please be sure to contact us immediately.

Standard Products

W.V. (V)	Cap. (±20 %) (μF)	Case size		Specification			Lead Length				Part No.	Min. Packaging Qty	
		Dia. (mm)	Length (mm)	Ripple Current (100 kHz) (+105 °C) (mA r.m.s.)	Impedance (100 kHz) (+20 °C) (Ω)	Endurance (hours)	Lead Dia. (mm)	Lead Space				Straight Leads (pcs)	Taping (pcs)
								Straight (mm)	Taping *B (mm)	Taping *H (mm)			
35	33	5	11	280	0.300	5000	0.5	2.0	5.0	2.5	EEUFR1V330()	200	2000
	68	6.3	11.2	455	0.130	5000	0.5	2.5	5.0	2.5	EEUFR1V680()	200	2000
	100	8	11.5	950	0.056	6000	0.6	3.5	5.0		EEUFR1V101()	200	1000
	180	8	11.5	950	0.056	6000	0.6	3.5	5.0		EEUFR1V181()	200	1000
	220	8	11.5	950	0.056	6000	0.6	3.5	5.0		EEUFR1V221()	200	1000
	270	8	15	1240	0.041	8000	0.6	3.5	5.0		EEUFR1V271L()	200	1000
		10	12.5	1290	0.043	6000	0.6	5.0	5.0		EEUFR1V271()	200	500
	330	10	12.5	1330	0.043	5000	0.6	5.0	5.0		EEUFR1V331U()	200	500
	390	8	20	1560	0.030	9000	0.6	3.5	5.0		EEUFR1V391L()	200	1000
	470	8	20	1560	0.030	9000	0.6	3.5	5.0		EEUFR1V471L()	200	1000
		10	16	1790	0.028	8000	0.6	5.0	5.0		EEUFR1V471()	200	500
	560	10	20	2180	0.020	10000	0.6	5.0	5.0		EEUFR1V561()	200	500
	680	10	20	2180	0.020	10000	0.6	5.0	5.0		EEUFR1V681()	200	500
		10	25	2470	0.018	10000	0.6	5.0	5.0		EEUFR1V681L()	200	500
	820	10	25	2470	0.018	10000	0.6	5.0	5.0		EEUFR1V821L()	200	500
	1000	12.5	20	2600	0.018	10000	0.6	5.0	5.0		EEUFR1V102()	200	500
	1200	12.5	25	3190	0.015	10000	0.6	5.0	5.0		EEUFR1V122()	200	500
	1500	12.5	30	3630	0.013	10000	0.8	5.0			EEUFR1V152L	100	
		16	20	3300	0.017	10000	0.8	7.5	7.5		EEUFR1V152S()	100	250
	1800	12.5	35	3750	0.012	10000	0.8	5.0			EEUFR1V182L	100	
16		25	3820	0.014	10000	0.8	7.5	7.5		EEUFR1V182()	100	250	
2200	12.5	35	3750	0.012	10000	0.8	5.0			EEUFR1V222L	100		
	16	25	3820	0.014	10000	0.8	7.5	7.5		EEUFR1V222()	100	250	
50	4.7	5	11	185	0.620	5000	0.5	2.0	5.0	2.5	EEUFR1H4R7()	200	2000
	10	5	11	250	0.340	5000	0.5	2.0	5.0	2.5	EEUFR1H100()	200	2000
	22	5	11	250	0.340	5000	0.5	2.0	5.0	2.5	EEUFR1H220()	200	2000
	47	6.3	11.2	405	0.140	5000	0.5	2.5	5.0		EEUFR1H470()	200	2000
	56	6.3	11.2	405	0.140	5000	0.5	2.5	5.0	2.5	EEUFR1H560()	200	2000
	100	8	11.5	870	0.061	6000	0.6	3.5	5.0		EEUFR1H101()	200	1000
	120	8	15	1140	0.045	8000	0.6	3.5	5.0		EEUFR1H121L()	200	1000
	150	10	12.5	1170	0.042	6000	0.6	5.0	5.0		EEUFR1H151()	200	500
	180	8	20	1430	0.033	9000	0.6	3.5	5.0		EEUFR1H181L()	200	1000
	220	10	16	1650	0.030	8000	0.6	5.0	5.0		EEUFR1H221()	200	500
	270	10	20	1890	0.023	10000	0.6	5.0	5.0		EEUFR1H271()	200	500
	330	10	25	2150	0.022	10000	0.6	5.0	5.0		EEUFR1H331L()	200	500
	470	12.5	20	2260	0.022	10000	0.6	5.0	5.0		EEUFR1H471()	200	500
	560	12.5	25	2660	0.018	10000	0.6	5.0	5.0		EEUFR1H561()	200	500
	680	12.5	30	3160	0.016	10000	0.8	5.0			EEUFR1H681L	100	
	820	12.5	35	3270	0.014	10000	0.8	5.0			EEUFR1H821L	100	
16		20	2870	0.019	10000	0.8	7.5	7.5		EEUFR1H821S()	100	250	
1000	16	25	3320	0.016	10000	0.8	7.5	7.5		EEUFR1H102()	100	250	
63	18	5	11	175	0.510	5000	0.5	2.0	5.0	2.5	EEUFR1J180()	200	2000
	47	6.3	11.2	284	0.210	5000	0.5	2.5	5.0	2.5	EEUFR1J470()	200	2000
	82	8	11.5	566	0.092	6000	0.6	3.5	5.0		EEUFR1J820()	200	1000
	100	8	15	741	0.068	8000	0.6	3.5	5.0		EEUFR1J101L()	200	1000
		10	12.5	761	0.063	6000	0.6	5.0	5.0		EEUFR1J101()	200	500
	120	8	20	930	0.050	9000	0.6	3.5	5.0		EEUFR1J121L()	200	1000
		10	16	1073	0.045	8000	0.6	5.0	5.0		EEUFR1J121()	200	500
	150	8	20	930	0.050	9000	0.6	3.5	5.0		EEUFR1J151L()	200	1000
		10	16	1073	0.045	8000	0.6	5.0	5.0		EEUFR1J151()	200	500
	180	10	20	1229	0.035	10000	0.6	5.0	5.0		EEUFR1J181()	200	500
	220	10	25	1500	0.033	10000	0.6	5.0	5.0		EEUFR1J221L()	200	500
		10	20	1229	0.035	10000	0.6	5.0	5.0		EEUFR1J271U()	200	500
	270	10	25	1500	0.033	10000	0.6	5.0	5.0		EEUFR1J271L()	200	500
		12.5	20	1582	0.033	10000	0.6	5.0	5.0		EEUFR1J271()	200	500
	330	12.5	20	1582	0.033	10000	0.6	5.0	5.0		EEUFR1J331()	200	500
	390	12.5	25	1995	0.027	10000	0.6	5.0	5.0		EEUFR1J391()	200	500
	470	12.5	25	1995	0.027	10000	0.6	5.0	5.0		EEUFR1J471()	200	500
	560	12.5	30	2528	0.024	10000	0.8	5.0			EEUFR1J561L	100	
16		20	2153	0.029	10000	0.8	7.5	7.5		EEUFR1J561S()	100	250	
680	12.5	35	2780	0.021	10000	0.8	5.0			EEUFR1J681L	100		
820	16	25	2988	0.024	10000	0.8	7.5	7.5		EEUFR1J821()	100	250	
100	100	10	20	1500	0.084	10000	0.6	5.0	5.0		EEUFR2A101()	200	500

· When requesting taped product, please put the letter "B" or "H" between the "()". Lead wire pitch *B=5 mm, 7.5 mm, H=2.5 mm.
 · Please refer to the page of "Taping Dimensions".

Design and specifications are each subject to change without notice. Ask factory for the current technical specifications before purchase and/or use.
 Should a safety concern arise regarding this product, please be sure to contact us immediately.

Radial Lead Type

Series: **EB** Type: **A**



■ Features

- Endurance : +105 °C 5000 h to 10000 h
- High ripple high frequency (High Voltage)
- RoHS directive compliant

■ Specifications

Category Temp. Range	-40 °C to +105 °C	-25 °C to +105 °C
Rated W.V. Range	10 V.DC to 63 V.DC	160 V.DC to 450 V.DC
Nominal Cap. Range	2.2 μF to 3300 μF	10 μF to 330 μF
Capacitance Tolerance	±20 % (120 Hz/+20 °C)	
DC Leakage Current	I ≤ 0.01 CV or 3 (μA) After 2 minutes application of rated working voltage at +20 °C (Whichever is greater)	
tan δ	Please see the attached standard products list	
Endurance	After following life test with DC voltage and +105 °C±2 °C ripple current value applied (The sum of DC and ripple peak voltage shall not exceed the rated working voltage), when the capacitors are restored to 20 °C, the capacitors shall meet the limits specified below.	
	(10 to 63 V.DC) Duration : φ5×11 to φ8×11.5 : 5000 hours φ8×15 to φ12.5×25 : 10000 hours	
	Capacitance change	±30 % of initial measured value
	tan δ	≤ 300 % of initial specified value
	DC leakage current	≤ initial specified value
	(160 to 450 V.DC) Duration : 5000 hours	
	Capacitance change	±20 % of initial measured value
	DC leakage current	≤ initial specified value
Shelf Life	After storage for 1000 hours at +105 °C±2 °C with no voltage applied and then being stabilized at +20 °C, capacitors shall meet the limits specified in Endurance. (With voltage treatment)	

■ Frequency correction factor for ripple current (10 ~ 63 V.DC)

Capacitance (μF)	Frequency (Hz)				
	60	120	1 k	10 k	100 k
2.2 to 10	0.75	1.00	1.40	1.55	1.65
22 to 470	0.85	1.00	1.20	1.25	1.30
1000 to 3300	0.95	1.00	1.05	1.10	1.15

W. V. (V. DC)	Frequency (Hz)			
	120	1 k	10 k to 30k	30 k to 100k
160 to 250	0.55	0.85	0.90	1.00
350 to 450	0.50	0.80	0.90	1.00

■ Dimensions in mm (not to scale)

(Unit : mm)



Design and specifications are each subject to change without notice. Ask factory for the current technical specifications before purchase and/or use. Should a safety concern arise regarding this product, please be sure to contact us immediately.

03 Jun. 2014

Standard Products

Endurance : 105 °C $\phi 5 \times 11$ to $\phi 8 \times 11.5 = 5000$ h, $\phi 5 \times 15$ to $\phi 6.3 \times 15 = 7000$ h, $\phi 8 \times 15$ to $\phi 12.5 \times 25 = 10000$ h

W.V. (V)	Cap. ($\pm 20\%$) (μF)	Case size		Specification			Lead Length				Part No.	Min. Packaging Qty		
		Dia. (mm)	Length (mm)	Ripple Current (120 Hz) (+105 °C) (mA r.m.s.)	$\tan \delta$ (120 Hz) (+20 °C)	Endurance (hours)	Lead Dia. (mm)	Lead Space				Straight Leads (pcs)	Taping (pcs)	
								Straight (mm)	Taping *B (mm)	Taping *H (mm)				
10	100	5	15	105	0.30	7000	0.5	2.0	5.0	2.5	EEUEB1A101()***	200	2000	
		5	11	66	0.30	5000	0.5	2.0	5.0	2.5	EEUEB1A101S()	200	2000	
	220	6.3	15	152	0.30	7000	0.5	2.5	5.0	2.5	EEUEB1A221()***	200	2000	
		6.3	11.2	100	0.30	5000	0.5	2.5	5.0	2.5	EEUEB1A221S()	200	2000	
	470	8	15	278	0.30	10000	0.6	3.5	5.0		EEUEB1A471()	200	1000	
		8	11.5	180	0.30	5000	0.6	3.5	5.0		EEUEB1A471S()	200	1000	
16	2200	12.5	20	540	0.32	10000	0.6	5.0	5.0		EEUEB1A222()	200	500	
		12.5	25	802	0.34	10000	0.6	5.0	5.0		EEUEB1A332()	200	500	
	1000	10	20	430	0.25	10000	0.6	5.0	5.0		EEUEB1C102()	200	500	
		12.5	25	706	0.27	10000	0.6	5.0	5.0		EEUEB1C222()	200	500	
	25	47	5	15	78	0.22	7000	0.5	2.0	5.0	2.5	EEUEB1E470()***	200	2000
			5	11	55	0.22	5000	0.5	2.0	5.0	2.5	EEUEB1E470S()	200	2000
100		6.3	15	135	0.22	7000	0.5	2.5	5.0	2.5	EEUEB1E101()***	200	2000	
		6.3	11.2	95	0.22	5000	0.5	2.5	5.0	2.5	EEUEB1E101S()	200	2000	
220		8	11.5	125	0.22	5000	0.6	3.5	5.0		EEUEB1E221S()	200	1000	
330		8	15	255	0.22	10000	0.6	3.5	5.0		EEUEB1E331()	200	1000	
35	470	10	16	321	0.22	10000	0.6	5.0	5.0		EEUEB1E471()	200	500	
		12.5	20	498	0.22	10000	0.6	5.0	5.0		EEUEB1E102()	200	500	
	1000	5	15	66	0.18	7000	0.5	2.0	5.0	2.5	EEUEB1V330()***	200	2000	
		5	11	46	0.18	5000	0.5	2.0	5.0	2.5	EEUEB1V330S()	200	2000	
	220	8	15	197	0.18	10000	0.6	3.5	5.0		EEUEB1V221()	200	1000	
	330	10	16	278	0.18	10000	0.6	5.0	5.0		EEUEB1V331()	200	500	
50	470	10	20	349	0.18	10000	0.6	5.0	5.0		EEUEB1V471()	200	500	
		12.5	25	586	0.18	10000	0.6	5.0	5.0		EEUEB1V102()	200	500	
	0.47	5	11	4	0.15	5000	0.5	2.0	5.0	2.5	EEUEB1HR47S()**	200	2000	
		1	5	11	8	0.15	5000	0.5	2.0	5.0	2.5	EEUEB1H1R0S()**	200	2000
	2.2	5	11	15	0.15	5000	0.5	2.0	5.0	2.5	EEUEB1H2R2S()	200	2000	
	3.3	5	11	18	0.15	5000	0.5	2.0	5.0	2.5	EEUEB1H3R3S()	200	2000	
	4.7	5	11	18	0.15	5000	0.5	2.0	5.0	2.5	EEUEB1H4R7S()	200	2000	
	10	5	11	27	0.15	5000	0.5	2.0	5.0	2.5	EEUEB1H100S()	200	2000	
	22	5	15	55	0.15	7000	0.5	2.0	5.0	2.5	EEUEB1H220()***	200	2000	
		5	11	39	0.15	5000	0.5	2.0	5.0	2.5	EEUEB1H220S()	200	2000	
	47	6.3	15	87	0.15	7000	0.5	2.5	5.0	2.5	EEUEB1H470()***	200	2000	
		6.3	11.2	61	0.15	5000	0.5	2.5	5.0	2.5	EEUEB1H470S()	200	2000	
	100	8	11.5	99	0.15	5000	0.6	3.5	5.0		EEUEB1H101S()	200	1000	
	220	10	16	234	0.15	10000	0.6	5.0	5.0		EEUEB1H221()	200	500	
330	10	20	293	0.15	10000	0.6	5.0	5.0		EEUEB1H331()	200	500		
470	12.5	20	370	0.15	10000	0.6	5.0	5.0		EEUEB1H471()	200	500		
63	0.47	5	15	6	0.12	7000	0.5	2.0	5.0	2.5	EEUEB1JR47()**	200	2000	
		5	11	4.5	0.12	5000	0.5	2.0	5.0	2.5	EEUEB1JR47S()**	200	2000	
	1	5	15	12	0.12	7000	0.5	2.0	5.0	2.5	EEUEB1J1R0()**	200	2000	
		5	11	9	0.12	5000	0.5	2.0	5.0	2.5	EEUEB1J1R0S()**	200	2000	
	2.2	5	11	16.5	0.12	5000	0.5	2.0	5.0	2.5	EEUEB1J2R2S()	200	2000	
	3.3	5	15	30	0.12	7000	0.5	2.0	5.0	2.5	EEUEB1J3R3()***	200	2000	
		5	11	20	0.12	5000	0.5	2.0	5.0	2.5	EEUEB1J3R3S()	200	2000	
	4.7	5	15	30	0.12	7000	0.5	2.0	5.0	2.5	EEUEB1J4R7()***	200	2000	
		5	11	23	0.12	5000	0.5	2.0	5.0	2.5	EEUEB1J4R7S()	200	2000	
	10	5	15	46	0.12	7000	0.5	2.0	5.0	2.5	EEUEB1J100()***	200	2000	
		5	11	30	0.12	5000	0.5	2.0	5.0	2.5	EEUEB1J100S()	200	2000	
	22	6.3	15	55	0.12	7000	0.5	2.5	5.0	2.5	EEUEB1J220()***	200	2000	
		6.3	11.2	40	0.12	5000	0.5	2.5	5.0	2.5	EEUEB1J220S()	200	2000	
	33	6.3	15	71	0.12	7000	0.5	2.5	5.0	2.5	EEUEB1J330()***	200	2000	
6.3		11.2	50	0.12	5000	0.5	2.5	5.0	2.5	EEUEB1J330S()	200	2000		
47	8	15	94	0.12	10000	0.6	3.5	5.0		EEUEB1J470()	200	1000		
	8	11.5	80	0.12	5000	0.6	3.5	5.0		EEUEB1J470S()	200	1000		
100	8	15	180	0.12	10000	0.6	3.5	5.0		EEUEB1J101()	200	1000		
220	10	20	292	0.12	10000	0.6	5.0	5.0		EEUEB1J221()	200	500		
330	12.5	20	381	0.12	10000	0.6	5.0	5.0		EEUEB1J331()	200	500		
470	12.5	25	454	0.12	10000	0.6	5.0	5.0		EEUEB1J471()	200	500		

· When requesting taped product, please put the letter "B" or "H" between the "()". Lead wire pitch *B=5 mm, 7.5 mm, H=2.5 mm.

· Please refer to the page of "Taping Dimensions".

** Please kindly accept last shipment : 31/Mar/2015

*** Please kindly accept last shipment : 30/Jun/2015

Design and specifications are each subject to change without notice. Ask factory for the current technical specifications before purchase and/or use.
Should a safety concern arise regarding this product, please be sure to contact us immediately.

Standard Products

Endurance : 105 °C 5000 h

W.V.	Cap. (±20 %)	Case size		Specification			Lead Length			Part No.	Min. Packaging Q'ty		
		Dia.	Length	Ripple Current (100 kHz) (+105 °C) (mA r.m.s.)	tan δ (120 Hz) (+20 °C)	Endurance (hours)	Lead Dia.	Lead Space			Straight Leads	Taping	
								Straight	Taping *B				
(V)	(μF)	(mm)	(mm)	(mA r.m.s.)	(+20 °C)	(hours)	(mm)	(mm)	(mm)	(pcs)	(pcs)		
160	22	10	20	470	0.15	5000	0.6	5.0	5.0	EEUEB2C220()	200	500	
	33	10	20	470	0.15	5000	0.6	5.0	5.0	EEUEB2C330()	200	500	
	47	12.5	20	600	0.15	5000	0.6	5.0	5.0	EEUEB2C470()	200	500	
	68	12.5	25	750	0.15	5000	0.6	5.0	5.0	EEUEB2C680()	200	500	
		16	20	750	0.15	5000	0.8	7.5	7.5	EEUEB2C680S()	100	250	
	100	16	25	1060	0.15	5000	0.8	7.5	7.5	EEUEB2C101()	100	250	
		18	20	1060	0.15	5000	0.8	7.5	7.5	EEUEB2C101S()	100	250	
	150	16	31.5	1280	0.15	5000	0.8	7.5	–	EEUEB2C151	100	–	
		18	25	1280	0.15	5000	0.8	7.5	7.5	EEUEB2C151S()	100	250	
	220	16	31.5	1280	0.15	5000	0.8	7.5	–	EEUEB2C221	100	–	
18		25	1280	0.15	5000	0.8	7.5	7.5	EEUEB2C221S()	100	250		
330	18	31.5	1690	0.15	5000	0.8	7.5	–	EEUEB2C331	50	–		
200	22	10	20	470	0.15	5000	0.6	5.0	5.0	EEUEB2D220()	200	500	
	33	12.5	20	600	0.15	5000	0.6	5.0	5.0	EEUEB2D330()	200	500	
	47	12.5	20	600	0.15	5000	0.6	5.0	5.0	EEUEB2D470()	200	500	
	68	12.5	25	750	0.15	5000	0.6	5.0	5.0	EEUEB2D680()	200	500	
		16	20	750	0.15	5000	0.8	7.5	7.5	EEUEB2D680S()	100	250	
	100	16	25	1060	0.15	5000	0.8	7.5	7.5	EEUEB2D101()	100	250	
		18	20	1060	0.15	5000	0.8	7.5	7.5	EEUEB2D101S()	100	250	
	150	16	31.5	1280	0.15	5000	0.8	7.5	–	EEUEB2D151	100	–	
		18	25	1280	0.15	5000	0.8	7.5	7.5	EEUEB2D151S()	100	250	
	220	18	31.5	1690	0.15	5000	0.8	7.5	–	EEUEB2D221	50	–	
250	22	12.5	20	560	0.15	5000	0.6	5.0	5.0	EEUEB2E220()	200	500	
	33	12.5	20	560	0.15	5000	0.6	5.0	5.0	EEUEB2E330()	200	500	
	47	12.5	25	710	0.15	5000	0.6	5.0	5.0	EEUEB2E470()	200	500	
		16	20	710	0.15	5000	0.8	7.5	7.5	EEUEB2E470S()	100	250	
	68	16	25	990	0.15	5000	0.8	7.5	7.5	EEUEB2E680()	100	250	
		18	20	990	0.15	5000	0.8	7.5	7.5	EEUEB2E680S()	100	250	
	100	16	31.5	1200	0.15	5000	0.8	7.5	–	EEUEB2E101	100	–	
		18	25	1200	0.15	5000	0.8	7.5	7.5	EEUEB2E101S()	100	250	
	150	18	31.5	1470	0.15	5000	0.8	7.5	–	EEUEB2E151	50	–	
	350	10	10	20	270	0.20	5000	0.6	5.0	5.0	EEUEB2V100()	200	500
22		12.5	20	350	0.20	5000	0.6	5.0	5.0	EEUEB2V220()	200	500	
33		16	20	480	0.20	5000	0.8	7.5	7.5	EEUEB2V330S()	100	250	
		16	25	640	0.20	5000	0.8	7.5	7.5	EEUEB2V470()	100	250	
47		18	20	640	0.20	5000	0.8	7.5	7.5	EEUEB2V470S()	100	250	
		16	31.5	780	0.20	5000	0.8	7.5	–	EEUEB2V680	100	–	
68		18	25	780	0.20	5000	0.8	7.5	7.5	EEUEB2V680S()	100	250	
		100	18	31.5	970	0.20	5000	0.8	7.5	–	EEUEB2V101	50	–
400		10	10	20	250	0.24	5000	0.6	5.0	5.0	EEUEB2G100()	200	500
		22	12.5	25	410	0.24	5000	0.6	5.0	5.0	EEUEB2G220()	200	500
	16		20	410	0.24	5000	0.8	7.5	7.5	EEUEB2G220S()	100	250	
	33	16	25	600	0.24	5000	0.8	7.5	7.5	EEUEB2G330()	100	250	
		18	20	600	0.24	5000	0.8	7.5	7.5	EEUEB2G330S()	100	250	
	47	16	31.5	730	0.24	5000	0.8	7.5	–	EEUEB2G470	100	–	
		18	25	730	0.24	5000	0.8	7.5	7.5	EEUEB2G470S()	100	250	
	450	10	12.5	20	310	0.24	5000	0.6	5.0	5.0	EEUEB2W100()	200	500
		22	16	25	560	0.24	5000	0.8	7.5	7.5	EEUEB2W220()	100	250
			18	20	560	0.24	5000	0.8	7.5	7.5	EEUEB2W220S()	100	250
33		16	31.5	680	0.24	5000	0.8	7.5	–	EEUEB2W330()	100	–	
		18	25	680	0.24	5000	0.8	7.5	7.5	EEUEB2W330S()	100	250	
47		18	31.5	850	0.24	5000	0.8	7.5	–	EEUEB2W470	50	–	

· When requesting taped product, please put the letter "B" between the "()". Lead wire pitch *B=5 mm, 7.5 mm.
 · Please refer to the page of "Taping Dimensions".

Radial Lead Type

Series: **EE** Type: **A**

■ Features

- High ripple current (at high frequency):
40 % higher than ED Series
- Endurance: 105 °C 8000 h to 10000 h
- RoHS directive compliant

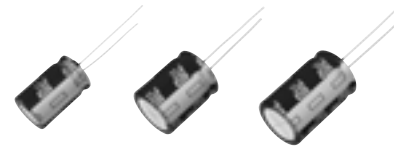

■ Specifications

Category Temp. Range	-25 °C to + 105 °C							
Rated W.V. Range	160 V .DC to 450 V .DC							
Nominal Cap. Range	10 μF to 330 μF							
Capacitance Tolerance	±20 % (120 Hz/+20 °C)							
DC Leakage Current	$I \leq 0.06 CV + 10$ (μA) After 2 minutes							
tan δ	W.V.	160	200	250	350	400	450	(120 Hz/+20 °C)
	tan δ	0.15	0.15	0.15	0.20	0.24	0.24	
Endurance	After following life test with DC voltage and +105 °C±2 °C ripple current value applied (The sum of DC and ripple peak voltage shall not exceed the rated working voltage), when the capacitors are restored to 20 °C, the capacitors shall meet the limits specified below. Duration φ10 : 8000 hours φ12.5 to φ18 : 10000 hours							
	Capacitance change	±20 % of initial measured value						
	tan δ	≤ 200 % of initial specified value						
	DC leakage current	≤ initial specified value						
Shelf Life	After storage for 1000 hours at +105 °C±2 °C with no voltage applied and then being stabilized at +20 °C, capacitors shall meet the limits specified in Endurance. (With voltage treatment)							

■ Frequency correction factor for ripple current

W. V. (V. DC)	Cap. (μF)	Frequency (Hz)					
		60 ≤	120 ≤	300 ≤	1 k ≤	10 k ≤	100 k ≤
160 to 450	10 to 82	0.25	0.35	0.50	0.65	0.90	1.00
	100 to 330	0.30	0.40	0.55	0.70	0.90	1.00

■ Dimensions in mm (not to scale)

(Unit : mm)

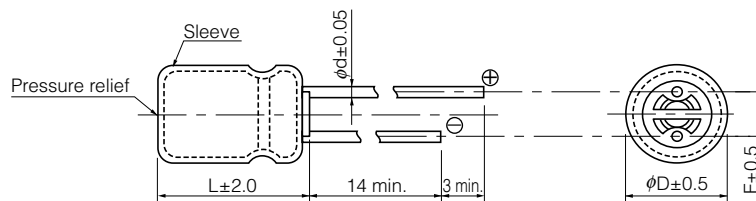

Body Dia. φD	10	12.5	16	18
Lead Dia. φd	0.6	0.6	0.8	0.8
Lead space F	5.0	5.0	7.5	7.5

Design and specifications are each subject to change without notice. Ask factory for the current technical specifications before purchase and/or use.
Should a safety concern arise regarding this product, please be sure to contact us immediately.

02 May, 2014

■ Case size/Ripple current

Cap. (μ F)	160 V			200 V		
	Case size (ϕ D×L)	Ripple current (mA r.m.s.) 105 °C		Case size (ϕ D×L)	Ripple current (mA r.m.s.) 105 °C	
		120 Hz	100 kHz		120 Hz	100 kHz
22	10 × 20	245	700	10 × 20	300	850
33	10 × 20	280	810	10 × 20	320	920
47	10 × 20	370	1065	12.5 × 20	385	1100
68	12.5 × 20	470	1350	12.5 × 25 16 × 20S	465 465	1330 1330
82	12.5 × 25	520	1480	16 × 20S	510	1460
100	12.5 × 25 16 × 20S	660 680	1660 1700	16 × 25 18 × 20S	690 670	1730 1665
150	16 × 25 18 × 20S	755 730	1890 1820	16 × 25	740	1860
220	16 × 31.5 18 × 25S	910 780	2280 1950	18 × 31.5	1175	2600
330	18 × 31.5	1040	2600	18 × 40	1250	3120

Cap. (μ F)	250 V			350 V		
	Case size (ϕ D×L)	Ripple current (mA r.m.s.) 105 °C		Case size (ϕ D×L)	Ripple current (mA r.m.s.) 105 °C	
		120 Hz	100 kHz		120 Hz	100 kHz
15				10 × 20	170	480
22	10 × 20	275	785	12.5 × 20	230	660
33	12.5 × 20	350	995	12.5 × 25 16 × 20S	275 315	790 900
47	12.5 × 25 16 × 20S	450 490	1290 1400	16 × 25 18 × 20S	375 375	1070 1070
68	16 × 20S	490	1400	16 × 31.5 18 × 25S	535 465	1530 1330
82	16 × 25 18 × 20S	590 590	1680 1680	18 × 25S	535	1530
100	16 × 31.5 18 × 25S	840 840	2100 2100	18 × 31.5	640	1600
150	18 × 31.5	1010	2520			
220	18 × 40	1175	2940			

Cap. (μ F)	400 V			450 V		
	Case size (ϕ D×L)	Ripple current (mA r.m.s.) 105 °C		Case size (ϕ D×L)	Ripple current (mA r.m.s.) 105 °C	
		120 Hz	100 kHz		120 Hz	100 kHz
10	10 × 20	150	430	10 × 20U 12.5 × 20	115 170	330 490
15	12.5 × 20	205	590	12.5 × 25	270	780
22	12.5 × 25 16 × 20S	265 300	760 860	16 × 20S	330	945
33	16 × 20S	355	1020	16 × 25 18 × 20S	350 350	1000 1000
47	16 × 25 18 × 20S	410 410	1180 1180	16 × 31.5 18 × 25S	420 420	1200 1200
56				18 × 31.5	480	1380
68	18 × 25	515	1470	18 × 40	630	1800
82	18 × 31.5	575	1645			
100	18 × 40	825	2060			

Design and specifications are each subject to change without notice. Ask factory for the current technical specifications before purchase and/or use.
Should a safety concern arise regarding this product, please be sure to contact us immediately.

Standard Products

Endurance : 105 °C ϕ 10=8000 h, ϕ 12.5 to ϕ 18=10000 h

W.V.	Cap. ($\pm 20\%$)	Case size		Specification			Lead Length			Part No.	Min. Packaging Q'ty		
		Dia.	Length	Ripple Current (100 kHz) (+105 °C) (mA r.m.s.)	$\tan \delta$ (120 Hz) (+20 °C)	Endurance (hours)	Lead Dia.	Lead Space			Straight Leads (pcs)	Taping (pcs)	
								Straight	Taping *B				
(V)	(μ F)	(mm)	(mm)	(mA r.m.s.)	(120 Hz) (+20 °C)	(hours)	(mm)	(mm)	(mm)	(pcs)	(pcs)		
160	22	10	20	700	0.15	8000	0.6	5.0	5.0	EEUEE2C220()	200	500	
	33	10	20	810	0.15	8000	0.6	5.0	5.0	EEUEE2C330()	200	500	
	47	10	20	1065	0.15	8000	0.6	5.0	5.0	EEUEE2C470()	200	500	
	68	12.5	20	1350	0.15	10000	0.6	5.0	5.0	EEUEE2C680()	200	500	
	82	12.5	25	1480	0.15	10000	0.6	5.0	5.0	EEUEE2C820()	200	500	
	100	100	12.5	25	1660	0.15	10000	0.6	5.0	5.0	EEUEE2C101()	200	500
			16	20	1700	0.15	10000	0.8	7.5	7.5	EEUEE2C101S()	100	250
	150	150	16	25	1890	0.15	10000	0.8	7.5	7.5	EEUEE2C151()	100	250
			18	20	1820	0.15	10000	0.8	7.5	7.5	EEUEE2C151S()	100	250
	220	220	16	31.5	2280	0.15	10000	0.8	7.5		EEUEE2C221	100	
18			25	1950	0.15	10000	0.8	7.5	7.5	EEUEE2C221S()	100	250	
330	330	18	31.5	2600	0.15	10000	0.8	7.5		EEUEE2C331	50		
200	22	10	20	850	0.15	8000	0.6	5.0	5.0	EEUEE2D220()	200	500	
	33	10	20	920	0.15	8000	0.6	5.0	5.0	EEUEE2D330()	200	500	
	47	12.5	20	1100	0.15	10000	0.6	5.0	5.0	EEUEE2D470()	200	500	
	68	68	12.5	25	1330	0.15	10000	0.6	5.0	5.0	EEUEE2D680()	200	500
			16	20	1330	0.15	10000	0.8	7.5	7.5	EEUEE2D680S()	100	250
	82	16	20	1460	0.15	10000	0.8	7.5	7.5	EEUEE2D820S()	100	250	
	100	100	16	25	1730	0.15	10000	0.8	7.5	7.5	EEUEE2D101()	100	250
			18	20	1665	0.15	10000	0.8	7.5	7.5	EEUEE2D101S()	100	250
	150	150	16	25	1860	0.15	10000	0.8	7.5	7.5	EEUEE2D151()	100	250
	220	220	18	31.5	2600	0.15	10000	0.8	7.5		EEUEE2D221	50	
330	330	18	40	3120	0.15	10000	0.8	7.5		EEUEE2D331	50		
250	22	10	20	785	0.15	8000	0.6	5.0	5.0	EEUEE2E220()	200	500	
	33	12.5	20	995	0.15	10000	0.6	5.0	5.0	EEUEE2E330()	200	500	
	47	47	12.5	25	1290	0.15	10000	0.6	5.0	5.0	EEUEE2E470()	200	500
			16	20	1400	0.15	10000	0.8	7.5	7.5	EEUEE2E470S()	100	250
	68	16	20	1400	0.15	10000	0.8	7.5	7.5	EEUEE2E680S()	100	250	
	82	82	16	25	1680	0.15	10000	0.8	7.5	7.5	EEUEE2E820()	100	250
			18	20	1680	0.15	10000	0.8	7.5	7.5	EEUEE2E820S()	100	250
	100	100	16	31.5	2100	0.15	10000	0.8	7.5		EEUEE2E101	100	
			18	25	2100	0.15	10000	0.8	7.5	7.5	EEUEE2E101S()	100	250
	150	150	18	31.5	2520	0.15	10000	0.8	7.5		EEUEE2E151	50	
220	220	18	40	2940	0.15	10000	0.8	7.5		EEUEE2E221	50		
350	15	10	20	480	0.20	8000	0.6	5.0	5.0	EEUEE2V150()	200	500	
	22	12.5	20	660	0.20	10000	0.6	5.0	5.0	EEUEE2V220()	200	500	
	33	33	12.5	25	790	0.20	10000	0.6	5.0	5.0	EEUEE2V330()	200	500
			16	20	900	0.20	10000	0.8	7.5	7.5	EEUEE2V330S()	100	250
	47	47	16	25	1070	0.20	10000	0.8	7.5	7.5	EEUEE2V470()	100	250
			18	20	1070	0.20	10000	0.8	7.5	7.5	EEUEE2V470S()	100	250
	68	68	16	31.5	1530	0.20	10000	0.8	7.5		EEUEE2V680	100	
			18	25	1330	0.20	10000	0.8	7.5	7.5	EEUEE2V680S()	100	250
	82	82	18	25	1530	0.20	10000	0.8	7.5	7.5	EEUEE2V820S()	100	250
	100	100	18	31.5	1600	0.20	10000	0.8	7.5		EEUEE2V101	50	

· When requesting taped product, please put the letter "B" between the "()". Lead wire pitch *B=5 mm, 7.5 mm.
 · Please refer to the page of "Taping Dimensions".

■ Standard Products

Endurance : 105 °C ϕ 10=8000 h, ϕ 12.5 to ϕ 18=10000 h

W.V. (V)	Cap. (\pm 20 %) (μ F)	Case size		Specification			Lead Length			Part No.	Min. Packaging Q'ty	
		Dia. (mm)	Length (mm)	Ripple Current (100 kHz) (+105 °C) (mA r.m.s.)	tan δ (120 Hz) (+20 °C)	Endurance (hours)	Lead Dia. (mm)	Lead Space			Straight Leads (pcs)	Taping (pcs)
								Straight (mm)	Taping *B (mm)			
400	10	10	20	430	0.24	8000	0.6	5.0	5.0	EEUEE2G100()	200	500
	15	12.5	20	590	0.24	10000	0.6	5.0	5.0	EEUEE2G150()	200	500
	22	12.5	25	760	0.24	10000	0.6	5.0	5.0	EEUEE2G220()	200	500
		16	20	860	0.24	10000	0.8	7.5	7.5	EEUEE2G220S()	100	250
	33	16	20	1020	0.24	10000	0.8	7.5	7.5	EEUEE2G330S()	100	250
	47	16	25	1180	0.24	10000	0.8	7.5	7.5	EEUEE2G470()	100	250
		18	20	1180	0.24	10000	0.8	7.5	7.5	EEUEE2G470S()	100	250
	68	18	25	1470	0.24	10000	0.8	7.5	7.5	EEUEE2G680()	100	250
	82	18	31.5	1645	0.24	10000	0.8	7.5		EEUEE2G820	50	
100	18	40	2060	0.24	10000	0.8	7.5		EEUEE2G101	50		
450	10	10	20	330	0.24	8000	0.6	5.0	5.0	EEUEE2W100U()	200	500
		12.5	20	490	0.24	10000	0.6	5.0	5.0	EEUEE2W100()	200	500
	15	12.5	25	780	0.24	10000	0.6	5.0	5.0	EEUEE2W150()	200	500
	22	16	20	945	0.24	10000	0.8	7.5	7.5	EEUEE2W220S()	100	250
	33	16	25	1000	0.24	10000	0.8	7.5	7.5	EEUEE2W330()	100	250
		18	20	1000	0.24	10000	0.8	7.5	7.5	EEUEE2W330S()	100	250
	47	16	31.5	1200	0.24	10000	0.8	7.5		EEUEE2W470	100	
		18	25	1200	0.24	10000	0.8	7.5	7.5	EEUEE2W470S()	100	250
	56	18	31.5	1380	0.24	10000	0.8	7.5		EEUEE2W560	50	
68	18	40	1800	0.24	10000	0.8	7.5		EEUEE2W680	50		

- When requesting taped product, please put the letter "B" between the "()". Lead wire pitch *B=5 mm, 7.5 mm.
- Please refer to the page of "Taping Dimensions".

Radial Lead Type

Series: **TA** Type: **A**

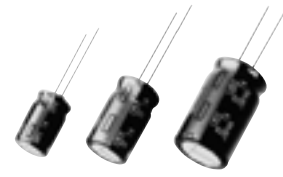

■ Features

- Endurance: 125 °C 2000 h
- Heat cycle: 1000 cycle -40 °C to +125 °C
- AEC-Q200 qualified*
- RoHS directive compliant

■ Specifications

Category Temp. Range	-40 °C to + 125 °C							
Rated W.V. Range	10 V .DC to 63 V .DC							
Nominal Cap. Range	2.2 μF to 4700 μF							
Capacitance Tolerance	±20 % (120 Hz/+20 °C)							
DC Leakage Current	$I \leq 0.01 CV$ or 3 (μA) After 2 minutes (Whichever is greater)							
tan δ	W.V.(V)	10	16	25	35	50	63	(120Hz / +20 °C)
	tan δ	0.20	0.16	0.14	0.12	0.10	0.09	
For capacitance value $\geq 1000 \mu\text{F}$, add 0.02 per every 1000 μF.								
Endurance	After following life test with DC voltage and +125 °C±2 °C ripple current value applied (The sum of DC and ripple peak voltage shall not exceed the rated working voltage), for 2000 hours, when the capacitors are restored to 20 °C, the capacitors, shall meet the limits specified below.							
	Capacitance change	±30% of initial measured value						
	tan δ	≤ 300 % of initial specified value						
	DC leakage current	≤ initial specified value						
Shelf Life	After storage for 1000 hours at +125 °C±2 °C with no voltage applied and then being stabilized at +20 °C, capacitors shall meet the limits specified in Endurance. (With voltage treatment)							

■ Frequency correction factor for ripple current

W.V. (V.DC)	Cap. (μF)	Frequency (Hz)				
		60	120	1 k	10 k	100 k
10 to 63	1 to 330	0.55	0.65	0.85	0.90	1.00
	470 to 1000	0.70	0.75	0.90	0.95	1.00
	2200 to 4700	0.75	0.80	0.90	0.95	1.00

■ Dimensions in mm (not to scale)

(Unit : mm)

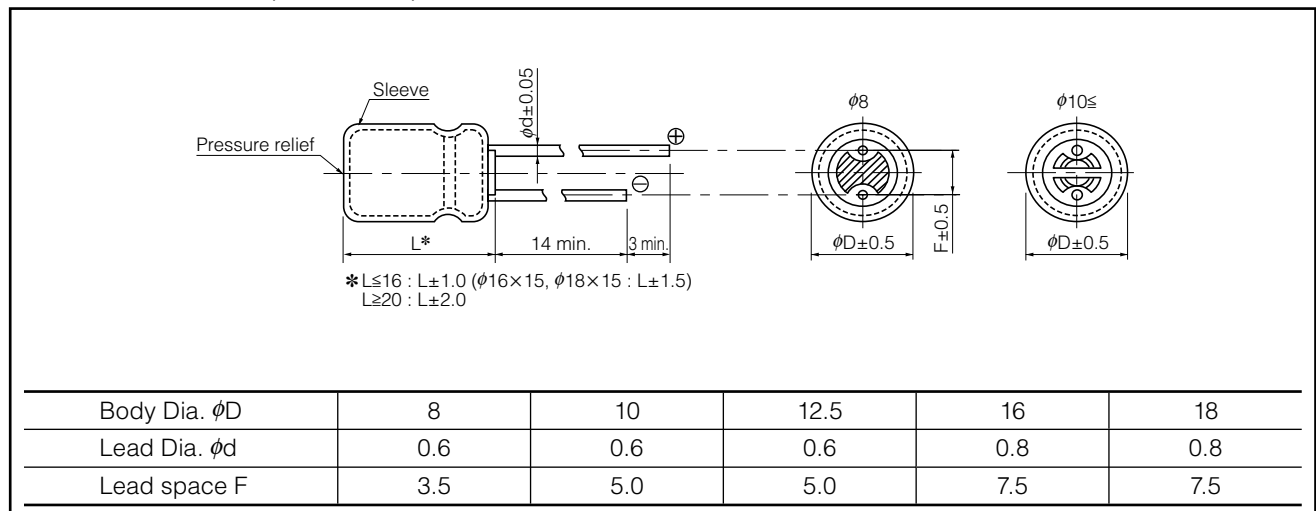

* This product qualify for AEC-Q200, but it has some deviations.

Design and specifications are each subject to change without notice. Ask factory for the current technical specifications before purchase and/or use. Should a safety concern arise regarding this product, please be sure to contact us immediately.

02 May. 2014

■ Standard Products

Endurance : 125 °C 2000 h

W.V.	Cap. (±20 %)	Case size		Specification		Lead Length			Part No.	Min. Packaging Q'ty		
		Dia.	Length	Ripple Current (100 kHz) (+125 °C) (mA r.m.s.)	Impedance (100 kHz) (+20 °C) (Ω)	Lead Dia. (mm)	Lead Space			Straight Leads (pcs)	Taping (pcs)	
							Straight (mm)	Taping *B (mm)				
(V)	(μF)	(mm)	(mm)	(mA r.m.s.)	(Ω)	(mm)	(mm)	(mm)		(pcs)	(pcs)	
10	330	8	11.5	500	0.130	0.6	3.5	5.0	EEUTA1A331()	200	1000	
	470	10	12.5	680	0.100	0.6	5.0	5.0	EEUTA1A471()	200	500	
	1000	10	20	1100	0.057	0.6	5.0	5.0	EEUTA1A102()	200	500	
			12.5	15	1085	0.070	0.6	5.0	5.0	EEUTA1A102S()	200	500
	2200	12.5	25	1750	0.033	0.6	5.0	5.0	EEUTA1A222L()	200	500	
			16	20	1985	0.032	0.8	7.5	7.5	EEUTA1A222()	100	250
			18	15	1800	0.042	0.8	7.5	7.5	EEUTA1A222S()	100	250
	3300	16	25	2300	0.024	0.8	7.5	7.5	EEUTA1A332()	100	250	
			18	20	2250	0.031	0.8	7.5	7.5	EEUTA1A332S()	100	250
	4700	16	31.5	2710	0.020	0.8	7.5		EEUTA1A472	100		
18			25	2470	0.022	0.8	7.5	7.5	EEUTA1A472S()	100	250	
16	220	8	11.5	500	0.130	0.6	3.5	5.0	EEUTA1C221()	200	1000	
	330	10	12.5	680	0.100	0.6	5.0	5.0	EEUTA1C331()	200	500	
	470	10	16	945	0.075	0.6	5.0	5.0	EEUTA1C471()	200	500	
	1000	12.5	20	1490	0.042	0.6	5.0	5.0	EEUTA1C102()	200	500	
			16	15	1520	0.047	0.8	7.5	7.5	EEUTA1C102S()	100	250
	2200	16	25	2300	0.024	0.8	7.5	7.5	EEUTA1C222()	100	250	
			18	20	2250	0.031	0.8	7.5	7.5	EEUTA1C222S()	100	250
	3300	16	31.5	2710	0.020	0.8	7.5		EEUTA1C332	100		
			18	25	2470	0.022	0.8	7.5	7.5	EEUTA1C332S()	100	250
	4700	18	31.5	3270	0.018	0.8	7.5		EEUTA1C472	50		
25	100	8	11.5	500	0.130	0.6	3.5	5.0	EEUTA1E101()	200	1000	
	220	10	12.5	680	0.100	0.6	5.0	5.0	EEUTA1E221()	200	500	
	330	10	16	945	0.075	0.6	5.0	5.0	EEUTA1E331()	200	500	
	470	10	20	1100	0.057	0.6	5.0	5.0	EEUTA1E471()	200	500	
			12.5	15	1085	0.070	0.6	5.0	5.0	EEUTA1E471S()	200	500
	1000	12.5	25	1750	0.033	0.6	5.0	5.0	EEUTA1E102L()	200	500	
			16	20	1985	0.032	0.8	7.5	7.5	EEUTA1E102()	100	250
			18	15	1800	0.042	0.8	7.5	7.5	EEUTA1E102S()	100	250
	2200	16	31.5	2710	0.020	0.8	7.5		EEUTA1E222	100		
			18	25	2470	0.022	0.8	7.5	7.5	EEUTA1E222S()	100	250
3300	18	35.5	3310	0.017	0.8	7.5		EEUTA1E332	50			
35	100	10	12.5	555	0.180	0.6	5.0	5.0	EEUTA1V101()	200	500	
	220	10	16	765	0.130	0.6	5.0	5.0	EEUTA1V221()	200	500	
	330	10	20	930	0.100	0.6	5.0	5.0	EEUTA1V331()	200	500	
	470	12.5	20	1330	0.070	0.6	5.0	5.0	EEUTA1V471()	200	500	
			16	15	1450	0.088	0.8	7.5	7.5	EEUTA1V471S()	100	250
	1000	16	25	2010	0.037	0.8	7.5	7.5	EEUTA1V102()	100	250	
			18	20	2180	0.046	0.8	7.5	7.5	EEUTA1V102S()	100	250
	2200	18	35.5	2790	0.025	0.8	7.5		EEUTA1V222	50		

- When requesting taped product, please put the letter "B" between the "()". Lead wire pitch *B=5 mm, 7.5 mm.
- Please refer to the page of "Taping Dimensions".

■ Standard Products

Endurance : 125 °C 2000 h

W.V.	Cap. (±20 %)	Case size		Specification		Lead Length			Part No.	Min. Packaging Q'ty	
		Dia.	Length	Ripple Current (100 kHz) (+125 °C) (mA r.m.s.)	Impedance (100 kHz) (+20 °C) (Ω)	Lead Dia.	Lead Space			Straight Leads	Taping
							Straight	Taping *B			
(V)	(μF)	(mm)	(mm)	(mA r.m.s.)	(Ω)	(mm)	(mm)	(mm)		(pcs)	(pcs)
50	1	8	11.5	35	2.00	0.6	3.5	5.0	EEUTA1H1R0()***	200	1000
	10	8	11.5	180	0.950	0.6	3.5	5.0	EEUTA1H100()	200	1000
	22	8	11.5	250	0.650	0.6	3.5	5.0	EEUTA1H220()	200	1000
	33	8	11.5	300	0.450	0.6	3.5	5.0	EEUTA1H330()	200	1000
	47	8	11.5	440	0.350	0.6	3.5	5.0	EEUTA1H470S()	200	1000
	100	10	12.5	555	0.180	0.6	5.0	5.0	EEUTA1H101()	200	500
	220	10	20	930	0.100	0.6	5.0	5.0	EEUTA1H221()	200	500
	330	12.5	20	1330	0.070	0.6	5.0	5.0	EEUTA1H331()	200	500
		16	15	1450	0.088	0.8	7.5	7.5	EEUTA1H331S()	100	250
	470	12.5	25	1650	0.055	0.6	5.0	5.0	EEUTA1H471L()	200	500
		16	20	1650	0.053	0.8	7.5	7.5	EEUTA1H471()	100	250
		18	15	1710	0.075	0.8	7.5	7.5	EEUTA1H471S()	100	250
	1000	16	31.5	2430	0.031	0.8	7.5		EEUTA1H102	100	
		18	25	2350	0.032	0.8	7.5	7.5	EEUTA1H102S()	100	250
	63	22	8	11.5	310	0.470	0.6	3.5	5.0	EEUTA1J220()	200
33		10	12.5	410	0.360	0.6	5.0	5.0	EEUTA1J330()	200	500
47		10	16	460	0.270	0.6	5.0	5.0	EEUTA1J470()	200	500
100		10	20	680	0.205	0.6	5.0	5.0	EEUTA1J101()	200	500
220		12.5	25	1325	0.100	0.6	5.0	5.0	EEUTA1J221L()	200	500
		16	20	1360	0.085	0.8	7.5	7.5	EEUTA1J221()	100	250
		18	15	1300	0.120	0.8	7.5	7.5	EEUTA1J221S()	100	250
330		16	25	1660	0.070	0.8	7.5	7.5	EEUTA1J331()	100	250
		18	20	1760	0.077	0.8	7.5	7.5	EEUTA1J331S()	100	250
470		16	31.5	2055	0.060	0.8	7.5		EEUTA1J471	100	
		18	25	1990	0.060	0.8	7.5	7.5	EEUTA1J471S()	100	250

· When requesting taped product, please put the letter "B" between the "()". Lead wire pitch *B=5 mm, 7.5 mm.

· Please refer to the page of "Taping Dimensions".

*** Please kindly accept last shipment : 31/Mar/2015

Radial Lead Type

Series: **TP** Type: **A**



■ Features

- Endurance: 125 °C 2000 h to 5000 h or 135 °C 1000 h to 2000 h
- Smaller than series TA
- High ripple current (at high frequency) : 20 to 40% higher than TA series
- AEC-Q200 qualified*
- RoHS directive compliant

■ Specifications

Category Temp. Range	-40 °C to + 135 °C		
Rated W.V. Range	25 V .DC to 35 V .DC		
Nominal Cap. Range	100 μF to 5100 μF		
Capacitance Tolerance	±20 % (120 Hz/+20 °C)		
DC Leakage Current	I ≤ 0.01 CV After 2 minutes		
tan δ	W.V.(V)	25	35
	tan δ	0.14	0.12
(120Hz / +20 °C) For capacitance value ≥ 1000 μF , add 0.02 per every 1000 μF.			
Endurance 1	After following life test with DC voltage and +125 °C±2 °C ripple current value applied. (The sum of DC and ripple peak voltage shall not exceed the rated working voltage) when the capacitors are restored to 20 °C, the capacitors shall meet the limits specified below. Duration φ8 : 2000 hours, φ10 : 3000 hours, φ12.5 : 4000 hours, φ16 to φ18 : 5000 hours		
	Capacitance change	±30% of initial measured value	
	tan δ	≤ 300 % of initial specified value	
	DC leakage current	≤ initial specified value	
Endurance 2	After following life test with DC voltage and +135 °C±2 °C ripple current value applied. (The sum of DC and ripple peak voltage shall not exceed the rated working voltage) when the capacitors are restored to 20 °C, the capacitors shall meet the limits specified below. Duration φ8 : 1000 hours, φ10 to φ18 : 2000 hours		
	Capacitance change	±30% of initial measured value	
	tan δ	≤ 300 % of initial specified value	
	DC leakage current	≤ initial specified value	
Shelf Life 1	After storage for 1000 hours at +125 °C±2 °C with no voltage applied and then being stabilized at +20 °C, capacitors shall meet the limits specified in Endurance. (With voltage treatment)		
Shelf Life 2	After storage for 1000 hours at +135 °C±2 °C with no voltage applied and then being stabilized at +20 °C, capacitors shall meet the limits specified in Endurance. (With voltage treatment)		

■ Frequency correction factor for ripple current

W.V. (V.DC)	Cap. (μF)	Frequency (Hz)				
		60	120	1 k	10 k	100 k
25 to 35	to 330	0.55	0.65	0.85	0.90	1.00
	390 to 1000	0.70	0.75	0.90	0.95	1.00
	1200 to	0.75	0.80	0.90	0.95	1.00

■ Dimensions in mm (not to scale)

(Unit : mm)

Body Dia. φD	8	10	12.5	16	18
Lead Dia. φd	0.6	0.6	0.6	0.8	0.8
Lead space F	3.5	5.0	5.0	7.5	7.5

* This product qualify for AEC-Q200, but it has some deviations.

Design and specifications are each subject to change without notice. Ask factory for the current technical specifications before purchase and/or use.
Should a safety concern arise regarding this product, please be sure to contact us immediately.

02 May. 2014

■ Standard Products

W.V.	Cap. (±20 %)	Case size		Specification						Lead Length			Part No. * : Substandard (E24series numbers)	Min. Packaging Q'ty	
		Dia.	Length	Ripple Current (100 kHz) (+125 °C) (mA r.m.s.)	Ripple Current (100 kHz) (+135 °C) (mA r.m.s.)	E.S.R (100 kHz) (+20 °C) (Ω)	tan δ (120 kHz) (+20 °C)	125 °C Endurance (hours)	135 °C Endurance (hours)	Lead Dia.	Lead Space			Straight Leads	Taping
											Straight	Taping *B			
(V)	(μF)	(mm)	(mm)							(mm)	(mm)				
25	220	10	12.5	580	500	0.190	0.14	3000	2000	0.6	5.0	5.0	EEUTP1E221()	200	500
	330	10	16	1100	945	0.130	0.14	3000	2000	0.6	5.0	5.0	EEUTP1E331()	200	500
	470	8	20	1060	760	0.067	0.14	2000	1000	0.6	3.5	5.0	EEUTP1E471L()	200	1000
		10	16	1100	945	0.130	0.14	3000	2000	0.6	5.0	5.0	EEUTP1E471()	200	500
	510	10	16	1100	945	0.130	0.14	3000	2000	0.6	5.0	5.0	EEUTP1E511()*	200	500
	820	10	20	1540	1100	0.052	0.14	3000	2000	0.6	5.0	5.0	EEUTP1E821()	200	500
	1000	12.5	20	1860	1490	0.038	0.14	4000	2000	0.6	5.0	5.0	EEUTP1E102()	200	500
	1200	12.5	20	1860	1490	0.038	0.14	4000	2000	0.6	5.0	5.0	EEUTP1E122()	200	500
	1800	12.5	25	2180	1750	0.030	0.14	4000	2000	0.6	5.0	5.0	EEUTP1E182()	200	500
		16	20	2380	1985	0.029	0.14	5000	2000	0.8	7.5	7.5	EEUTP1E182S()	100	250
	2000	16	20	2380	1985	0.029	0.16	5000	2000	0.8	7.5	7.5	EEUTP1E202S()*	100	250
	2200	16	25	2760	2300	0.022	0.16	5000	2000	0.8	7.5	7.5	EEUTP1E222()	100	250
		18	20	2700	2250	0.028	0.16	5000	2000	0.8	7.5	7.5	EEUTP1E222S()	100	250
	2700	16	25	2760	2300	0.022	0.16	5000	2000	0.8	7.5	7.5	EEUTP1E272()	100	250
		18	20	2700	2250	0.028	0.16	5000	2000	0.8	7.5	7.5	EEUTP1E272S()	100	250
	3300	16	31.5	3250	2710	0.018	0.18	5000	2000	0.8	7.5		EEUTP1E332	100	
		18	25	2960	2470	0.020	0.18	5000	2000	0.8	7.5	7.5	EEUTP1E332S()	100	250
	3900	16	31.5	3250	2710	0.018	0.18	5000	2000	0.8	7.5		EEUTP1E392	100	
		18	25	2960	2470	0.020	0.18	5000	2000	0.8	7.5	7.5	EEUTP1E392S()	100	250
	4700	18	31.5	3480	2900	0.016	0.20	5000	2000	0.8	7.5		EEUTP1E472	50	
5100	18	31.5	3480	2900	0.016	0.22	5000	2000	0.8	7.5		EEUTP1E512*	50		
35	100	10	12.5	580	500	0.190	0.12	3000	2000	0.6	5.0	5.0	EEUTP1V101()	200	500
	120	10	12.5	580	500	0.190	0.12	3000	2000	0.6	5.0	5.0	EEUTP1V121()	200	500
	220	8	20	1060	760	0.067	0.12	2000	1000	0.6	3.5	5.0	EEUTP1V221L()	200	1000
		10	16	1100	945	0.130	0.12	3000	2000	0.6	5.0	5.0	EEUTP1V221()	200	500
	270	8	20	1060	760	0.067	0.12	2000	1000	0.6	3.5	5.0	EEUTP1V271L()	200	1000
		10	16	1100	945	0.130	0.12	3000	2000	0.6	5.0	5.0	EEUTP1V271()	200	500
	330	10	20	1540	1100	0.052	0.12	3000	2000	0.6	5.0	5.0	EEUTP1V331()	200	500
	390	10	20	1540	1100	0.052	0.12	3000	2000	0.6	5.0	5.0	EEUTP1V391()	200	500
	470	12.5	20	1860	1490	0.038	0.12	4000	2000	0.6	5.0	5.0	EEUTP1V471()	200	500
	560	12.5	20	1860	1490	0.038	0.12	4000	2000	0.6	5.0	5.0	EEUTP1V561()	200	500
	620	12.5	20	1860	1490	0.038	0.12	4000	2000	0.6	5.0	5.0	EEUTP1V621()*	200	500
	820	12.5	25	2180	1750	0.030	0.12	4000	2000	0.6	5.0	5.0	EEUTP1V821()	200	500
	1000	16	20	2380	1985	0.029	0.12	5000	2000	0.8	7.5	7.5	EEUTP1V102()	100	250
	1200	16	20	2380	1985	0.029	0.12	5000	2000	0.8	7.5	7.5	EEUTP1V122()	100	250
	1500	16	25	2760	2300	0.022	0.12	5000	2000	0.8	7.5	7.5	EEUTP1V152()	100	250
		18	20	2700	2250	0.028	0.12	5000	2000	0.8	7.5	7.5	EEUTP1V152S()	100	250
	1600	16	25	2760	2300	0.022	0.12	5000	2000	0.8	7.5	7.5	EEUTP1V162()*	100	250
	1800	16	31.5	3250	2710	0.018	0.12	5000	2000	0.8	7.5		EEUTP1V182	100	
		18	25	2960	2470	0.020	0.12	5000	2000	0.8	7.5	7.5	EEUTP1V182S()	100	250
	2000	16	31.5	3250	2710	0.018	0.14	5000	2000	0.8	7.5		EEUTP1V202*	100	
18		25	2960	2470	0.020	0.14	5000	2000	0.8	7.5	7.5	EEUTP1V202S()*	100	250	
2200	18	31.5	3480	2900	0.016	0.14	5000	2000	0.8	7.5		EEUTP1V222	50		
2700	18	31.5	3480	2900	0.016	0.14	5000	2000	0.8	7.5		EEUTP1V272	50		

· When requesting taped product, please put the letter "B" between the "()". Lead wire pitch *B=5 mm, 7.5 mm.
 · Please refer to the page of "Taping Dimensions".

Radial Lead Type

Series: **NHG** Type: **A**



■ Features

- Endurance : 105 °C 1000 h to 2000 h
- RoHS directive compliant

■ Specifications

Category Temp. Range	-55 °C to +105 °C	-25 °C to +105 °C
Rated W.V. Range	6.3 V.DC to 100 V.DC	160 V.DC to 450 V.DC
Nominal Cap. Range	2.2 μF to 22000 μF	1 μF to 330 μF
Capacitance Tolerance	±20 % (120 Hz/+20 °C)	
DC Leakage Current	$I \leq 0.01 CV$ or $3 (\mu A)$ After 2 minutes (Which is greater)	$I \leq 0.06 CV + 10 (\mu A)$ After 2 minutes
tan δ	Please see the attached standard products list	
Endurance	After following life test with DC voltage and +105 °C±2 °C ripple current value applied (The sum of DC and ripple peak voltage shall not exceed the rated working voltage), When the capacitors are restored to 20 °C, the capacitors shall meet the limits specified below. Duration : 6.3 V.DC to 100 V.DC : (φ5 to φ8)=1000 hours, (φ10 to φ18)=2000 hours 160 V.DC to 450 V.DC : 2000 hours	
	Capacitance change	±20 % of initial measured value
	tan δ	≤ 200 % of initial specified value
	DC leakage current	≤ initial specified value
Shelf Life	After storage for 1000 hours at +105 °C±2 °C with no voltage applied and then being stabilized at +20 °C, capacitors shall meet the limits specified in Endurance. (With voltage treatment)	

■ Frequency correction factor for ripple current

W.V.(V.DC)	Cap. (μF)	Frequency (Hz)				
		60	120	1 k	10 k	100 k
6.3 to 100	2.2 to 33	0.75	1.00	1.55	1.80	2.00
	47 to 470	0.80	1.00	1.35	1.50	1.50
	1000 to 22000	0.85	1.00	1.10	1.15	1.15
160 to 450	1 to 330	0.80	1.00	1.35	1.50	1.50

■ Dimensions in mm (not to scale)

(Unit : mm)



Design and specifications are each subject to change without notice. Ask factory for the current technical specifications before purchase and/or use. Should a safety concern arise regarding this product, please be sure to contact us immediately.

02 May. 2014

■ Standard Products

W.V. (V)	Cap. (±20 %) (μF)	Case size		Specification			Lead Length				Part No.	Min. Packaging Q'ty	
		Dia. (mm)	Length (mm)	Ripple Current (120 Hz) (+105 °C) (mA r.m.s.)	tan δ (120 Hz) (+20 °C)	Endurance (hours)	Lead Dia. (mm)	Lead Space				Straight Leads (pcs)	Taping (pcs)
								Straight (mm)	Taping *B (mm)	Taping *i (mm)			
6.3	220	5	11	140	0.28	1000	0.5	2.0	5.0	2.5	ECA0JHG221()	200	2000
	470	6.3	11.2	230	0.28	1000	0.5	2.5	5.0	2.5	ECA0JHG471()	200	2000
	1000	8	11.5	380	0.28	1000	0.6	3.5	5.0		ECA0JHG102()	200	1000
	2200	10	16	710	0.30	2000	0.6	5.0	5.0		ECA0JHG222()	200	500
	3300	10	20	840	0.32	2000	0.6	5.0	5.0		ECA0JHG332()	200	500
	4700	12.5	20	1090	0.34	2000	0.6	5.0	5.0		ECA0JHG472()	200	500
	6800	12.5	25	1350	0.38	2000	0.6	5.0	5.0		ECA0JHG682()	200	500
	10000	16	25	1650	0.46	2000	0.8	7.5	7.5		ECA0JHG103()	100	250
	15000	16	31.5	2010	0.56	2000	0.8	7.5			ECA0JHG153	100	
10	330	6.3	11.2	200	0.24	1000	0.5	2.5	5.0	2.5	ECA1AHG331()	200	2000
	470	8	11.5	250	0.24	1000	0.6	3.5	5.0		ECA1AHG471()	200	1000
	1000	10	12.5	460	0.24	2000	0.6	5.0	5.0		ECA1AHG102()	200	500
	2200	10	20	760	0.26	2000	0.6	5.0	5.0		ECA1AHG222()	200	500
	3300	12.5	20	1000	0.28	2000	0.6	5.0	5.0		ECA1AHG332()	200	500
	4700	12.5	25	1260	0.30	2000	0.6	5.0	5.0		ECA1AHG472()	200	500
	6800	16	25	1570	0.34	2000	0.8	7.5	7.5		ECA1AHG682()	100	250
	10000	16	31.5	1890	0.42	2000	0.8	7.5			ECA1AHG103	100	
	15000	18	35.5	2180	0.52	2000	0.8	7.5			ECA1AHG153	50	
16	100	5	11	110	0.20	1000	0.5	2.0	5.0	2.5	ECA1CHG101()	200	2000
	220	6.3	11.2	180	0.20	1000	0.5	2.5	5.0	2.5	ECA1CHG221()	200	2000
	330	8	11.5	260	0.20	1000	0.6	3.5	5.0		ECA1CHG331()	200	1000
	470	8	11.5	310	0.20	1000	0.6	3.5	5.0		ECA1CHG471()	200	1000
	1000	10	16	560	0.20	2000	0.6	5.0	5.0		ECA1CHG102()	200	500
	2200	12.5	20	920	0.22	2000	0.6	5.0	5.0		ECA1CHG222()	200	500
	3300	12.5	25	1170	0.24	2000	0.6	5.0	5.0		ECA1CHG332()	200	500
	4700	16	25	1480	0.26	2000	0.8	7.5	7.5		ECA1CHG472()	100	250
	6800	16	31.5	1780	0.30	2000	0.8	7.5			ECA1CHG682	100	
	10000	18	35.5	2060	0.38	2000	0.8	7.5			ECA1CHG103	50	
25	47	5	11	91	0.16	1000	0.5	2.0	5.0	2.5	ECA1EHG470()	200	2000
	100	6.3	11.2	130	0.16	1000	0.5	2.5	5.0	2.5	ECA1EHG101()	200	2000
	220	8	11.5	230	0.16	1000	0.6	3.5	5.0		ECA1EHG221()	200	1000
	330	8	11.5	310	0.16	1000	0.6	3.5	5.0		ECA1EHG331()	200	1000
	470	10	12.5	380	0.16	2000	0.6	5.0	5.0		ECA1EHG471()	200	500
	1000	10	20	680	0.16	2000	0.6	5.0	5.0		ECA1EHG102()	200	500
	2200	12.5	25	1090	0.18	2000	0.6	5.0	5.0		ECA1EHG222()	200	500
	3300	16	25	1400	0.20	2000	0.8	7.5	7.5		ECA1EHG332()	100	250
	4700	16	31.5	1750	0.22	2000	0.8	7.5			ECA1EHG472	100	
	6800	18	35.5	2040	0.26	2000	0.8	7.5			ECA1EHG682	50	
35	47	5	11	90	0.14	1000	0.5	2.0	5.0	2.5	ECA1VHG470()	200	2000
	100	6.3	11.2	150	0.14	1000	0.5	2.5	5.0	2.5	ECA1VHG101()	200	2000
	220	8	11.5	270	0.14	1000	0.6	3.5	5.0		ECA1VHG221()	200	1000
	330	10	12.5	350	0.14	2000	0.6	5.0	5.0		ECA1VHG331()	200	500
	470	10	16	460	0.14	2000	0.6	5.0	5.0		ECA1VHG471()	200	500
	1000	12.5	20	810	0.14	2000	0.6	5.0	5.0		ECA1VHG102()	200	500
	2200	16	25	1260	0.16	2000	0.8	7.5	7.5		ECA1VHG222()	100	250
	3300	16	31.5	1610	0.18	2000	0.8	7.5			ECA1VHG332	100	
	4700	18	35.5	1910	0.20	2000	0.8	7.5			ECA1VHG472	50	

· When requesting taped product, please put the letter "B" or "i" between the "()". Lead wire pitch *B=5 mm, 7.5 mm, i=2.5 mm.
 · Please refer to the page of "Taping Dimensions".

■ Standard Products

W.V. (V)	Cap. (±20 %) (μF)	Case size		Specification			Lead Length				Part No.	Min. Packaging Qty	
		Dia. (mm)	Length (mm)	Ripple Current (120 Hz) (+105 °C) (mA r.m.s.)	tan δ (120 Hz) (+20 °C)	Endurance (hours)	Lead Dia. (mm)	Lead Space				Straight Leads (pcs)	Taping (pcs)
								Straight (mm)	Taping *B (mm)	Taping *i (mm)			
50	0.1	5	11	1.1	0.12	1000	0.5	2.0	5.0	2.5	ECA1HHG0R1()***	200	2000
	0.22	5	11	2.3	0.12	1000	0.5	2.0	5.0	2.5	ECA1HHGR22()***	200	2000
	0.33	5	11	3.5	0.12	1000	0.5	2.0	5.0	2.5	ECA1HHGR33()***	200	2000
	0.47	5	11	5	0.12	1000	0.5	2.0	5.0	2.5	ECA1HHGR47()***	200	2000
	1	5	11	10	0.12	1000	0.5	2.0	5.0	2.5	ECA1HHG010()***	200	2000
	2.2	5	11	18	0.12	1000	0.5	2.0	5.0	2.5	ECA1HHG2R2()	200	2000
	3.3	5	11	22	0.12	1000	0.5	2.0	5.0	2.5	ECA1HHG3R3()	200	2000
	4.7	5	11	26	0.12	1000	0.5	2.0	5.0	2.5	ECA1HHG4R7()	200	2000
	10	5	11	39	0.12	1000	0.5	2.0	5.0	2.5	ECA1HHG100()	200	2000
	22	5	11	65	0.12	1000	0.5	2.0	5.0	2.5	ECA1HHG220()	200	2000
	33	5	11	90	0.12	1000	0.5	2.0	5.0	2.5	ECA1HHG330()	200	2000
	47	6.3	11.2	110	0.12	1000	0.5	2.5	5.0	2.5	ECA1HHG470()	200	2000
	100	8	11.5	180	0.12	1000	0.6	3.5	5.0		ECA1HHG101()	200	1000
	220	10	12.5	300	0.12	2000	0.6	5.0	5.0		ECA1HHG221()	200	500
	330	10	16	410	0.12	2000	0.6	5.0	5.0		ECA1HHG331()	200	500
	470	10	20	530	0.12	2000	0.6	5.0	5.0		ECA1HHG471()	200	500
	1000	12.5	25	950	0.12	2000	0.6	5.0	5.0		ECA1HHG102()	200	500
2200	16	31.5	1470	0.14	2000	0.8	7.5			ECA1HHG222	100		
3300	18	35.5	1770	0.16	2000	0.8	7.5			ECA1HHG332	50		
63	10	5	11	46	0.10	1000	0.5	2.0	5.0	2.5	ECA1JHG100()	200	2000
	22	5	11	71	0.10	1000	0.5	2.0	5.0	2.5	ECA1JHG220()	200	2000
	33	6.3	11.2	100	0.10	1000	0.5	2.5	5.0	2.5	ECA1JHG330()	200	2000
	47	6.3	11.2	120	0.10	1000	0.5	2.5	5.0	2.5	ECA1JHG470()	200	2000
	100	10	12.5	215	0.10	2000	0.6	5.0	5.0		ECA1JHG101()	200	500
	220	10	16	335	0.10	2000	0.6	5.0	5.0		ECA1JHG221()	200	500
	330	10	20	510	0.10	2000	0.6	5.0	5.0		ECA1JHG331()	200	500
	470	12.5	20	640	0.10	2000	0.6	5.0	5.0		ECA1JHG471()	200	500
	1000	16	25	930	0.10	2000	0.8	7.5	7.5		ECA1JHG102()	100	250
	2200	18	35.5	1610	0.12	2000	0.8	7.5			ECA1JHG222	50	
100	0.47	5	11	9	0.08	1000	0.5	2.0	5.0	2.5	ECA2AHGR47()***	200	2000
	1	5	11	14	0.08	1000	0.5	2.0	5.0	2.5	ECA2AHG010()***	200	2000
	2.2	5	11	21	0.08	1000	0.5	2.0	5.0	2.5	ECA2AHG2R2()	200	2000
	3.3	5	11	31	0.08	1000	0.5	2.0	5.0	2.5	ECA2AHG3R3()	200	2000
	4.7	5	11	38	0.08	1000	0.5	2.0	5.0	2.5	ECA2AHG4R7()	200	2000
	10	6.3	11.2	54	0.08	1000	0.5	2.5	5.0	2.5	ECA2AHG100()	200	2000
	22	6.3	11.2	93	0.08	1000	0.5	2.5	5.0	2.5	ECA2AHG220()	200	2000

· When requesting taped product, please put the letter "B" or "i" between the "()". Lead wire pitch *B=5 mm, 7.5 mm, i=2.5 mm.

· Please refer to the page of "Taping Dimensions".

*** Please kindly accept last shipment : 31/Mar/2015

Standard Products

W.V. (V)	Cap. (±20 %) (μF)	Case size		Specification			Lead Length				Part No.	Min. Packaging Qty	
		Dia. (mm)	Length (mm)	Ripple Current (120 Hz) (+105 °C) (mA r.m.s.)	tan δ (120 Hz) (+20 °C)	Endurance (hours)	Lead Dia. (mm)	Lead Space				Straight Leads (pcs)	Taping (pcs)
								Straight (mm)	Taping *B (mm)	Taping *i (mm)			
100	33	8	11.5	130	0.08	1000	0.6	3.5	5.0		ECA2AHG330()	200	1000
	47	10	12.5	165	0.08	2000	0.6	5.0	5.0		ECA2AHG470()	200	500
	100	10	20	265	0.08	2000	0.6	5.0	5.0		ECA2AHG101()	200	500
	220	12.5	25	440	0.08	2000	0.6	5.0	5.0		ECA2AHG221()	200	500
	330	16	25	540	0.08	2000	0.8	7.5	7.5		ECA2AHG331()	100	250
	470	16	25	715	0.08	2000	0.8	7.5	7.5		ECA2AHG471()	100	250
	1000	18	35.5	985	0.08	2000	0.8	7.5			ECA2AHG102	50	
160	1	6.3	11.2	17	0.15	2000	0.5	2.5	5.0	2.5	ECA2CHG010()	200	2000
	2.2	6.3	11.2	25	0.15	2000	0.5	2.5	5.0	2.5	ECA2CHG2R2()	200	2000
	3.3	6.3	11.2	36	0.15	2000	0.5	2.5	5.0	2.5	ECA2CHG3R3()	200	2000
	4.7	6.3	11.2	43	0.15	2000	0.5	2.5	5.0	2.5	ECA2CHG4R7()	200	2000
	10	10	12.5	70	0.15	2000	0.6	5.0	5.0		ECA2CHG100()	200	500
	22	10	20	130	0.15	2000	0.6	5.0	5.0		ECA2CHG220()	200	500
	33	10	20	180	0.15	2000	0.6	5.0	5.0		ECA2CHG330()	200	500
	47	12.5	20	220	0.15	2000	0.6	5.0	5.0		ECA2CHG470()	200	500
	100	16	25	335	0.15	2000	0.8	7.5	7.5		ECA2CHG101()	100	250
	220	16	31.5	540	0.15	2000	0.8	7.5			ECA2CHG221	100	
330	18	31.5	705	0.15	2000	0.8	7.5			ECA2CHG331	50		
200	1	6.3	11.2	17	0.15	2000	0.5	2.5	5.0	2.5	ECA2DHG010()	200	2000
	2.2	6.3	11.2	25	0.15	2000	0.5	2.5	5.0	2.5	ECA2DHG2R2()	200	2000
	3.3	6.3	11.2	36	0.15	2000	0.5	2.5	5.0	2.5	ECA2DHG3R3()	200	2000
	4.7	8	11.5	50	0.15	2000	0.6	3.5	5.0		ECA2DHG4R7()	200	1000
	10	10	16	80	0.15	2000	0.6	5.0	5.0		ECA2DHG100()	200	500
	22	10	20	140	0.15	2000	0.6	5.0	5.0		ECA2DHG220()	200	500
	33	12.5	20	190	0.15	2000	0.6	5.0	5.0		ECA2DHG330()	200	500
	47	12.5	20	220	0.15	2000	0.6	5.0	5.0		ECA2DHG470()	200	500
	100	16	25	335	0.15	2000	0.8	7.5	7.5	2.5	ECA2DHG101()	100	250
	220	18	31.5	575	0.15	2000	0.8	7.5			ECA2DHG221	50	
250	1	6.3	11.2	17	0.15	2000	0.5	2.5	5.0	2.5	ECA2EHG010()	200	2000
	2.2	6.3	11.2	29	0.15	2000	0.5	2.5	5.0	2.5	ECA2EHG2R2()	200	2000
	3.3	8	11.5	42	0.15	2000	0.6	3.5	5.0		ECA2EHG3R3	200	1000
	4.7	8	11.5	50	0.15	2000	0.6	3.5	5.0		ECA2EHG4R7()	200	1000
	10	10	16	88	0.15	2000	0.6	5.0	5.0		ECA2EHG100()	200	500
	22	12.5	20	155	0.15	2000	0.6	5.0	5.0		ECA2EHG220()	200	500
	33	12.5	20	190	0.15	2000	0.6	5.0	5.0		ECA2EHG330()	200	500
	47	12.5	25	230	0.15	2000	0.6	5.0	5.0		ECA2EHG470()	200	500
	100	16	31.5	365	0.15	2000	0.8	7.5			ECA2EHG101	100	
350	1	6.3	11.2	18	0.20	2000	0.5	2.5	5.0	2.5	ECA2VHG010()	200	2000
	2.2	8	11.5	31	0.20	2000	0.6	3.5	5.0		ECA2VHG2R2()	200	1000
	3.3	10	12.5	38	0.20	2000	0.6	5.0	5.0		ECA2VHG3R3()	200	500
	4.7	10	16	50	0.20	2000	0.6	5.0	5.0		ECA2VHG4R7()	200	500
	10	10	20	82	0.20	2000	0.6	5.0	5.0		ECA2VHG100()	200	500
	22	12.5	20	130	0.20	2000	0.6	5.0	5.0		ECA2VHG220()	200	500
	33	16	25	195	0.20	2000	0.8	7.5	7.5		ECA2VHG330()	100	250
	47	16	25	230	0.20	2000	0.8	7.5	7.5		ECA2VHG470()	100	250
	100	18	31.5	375	0.20	2000	0.8	7.5			ECA2VHG101	50	

· When requesting taped product, please put the letter "B" or "I" between the "()". Lead wire pitch *B=5 mm, 7.5 mm, i=2.5 mm.
 · Please refer to the page of "Taping Dimensions".

■ Standard Products

W.V. (V)	Cap. (±20 %) (μF)	Case size		Specification			Lead Length				Part No.	Min. Packaging Q'ty	
		Dia. (mm)	Length (mm)	Ripple Current (120 Hz) (+105 °C) (mA r.m.s.)	tan δ (120 Hz) (+20 °C)	Endurance (hours)	Lead Dia. (mm)	Lead Space				Straight Leads (pcs)	Taping (pcs)
								Straight (mm)	Taping *B (mm)	Taping *i (mm)			
400	1	6.3	11.2	18	0.24	2000	0.5	2.5	5.0	2.5	ECA2GHG010()	200	2000
	2.2	8	11.5	30	0.24	2000	0.6	3.5	5.0		ECA2GHG2R2()	200	1000
	3.3	10	12.5	40	0.24	2000	0.6	5.0	5.0		ECA2GHG3R3()	200	500
	4.7	10	16	50	0.24	2000	0.6	5.0	5.0		ECA2GHG4R7()	200	500
	10	10	20	80	0.24	2000	0.6	5.0	5.0		ECA2GHG100()	200	500
	22	12.5	25	145	0.24	2000	0.6	5.0	5.0		ECA2GHG220()	200	500
	33	16	25	195	0.24	2000	0.8	7.5	7.5		ECA2GHG330()	100	250
450	47	16	31.5	250	0.24	2000	0.8	7.5			ECA2GHG470	100	
	1	8	11.5	18	0.24	2000	0.6	3.5	5.0		ECA2WHG010()	200	1000
	2.2	10	12.5	29	0.24	2000	0.6	5.0	5.0		ECA2WHG2R2()	200	500
	3.3	10	16	41	0.24	2000	0.6	5.0	5.0		ECA2WHG3R3()	200	500
	4.7	10	20	49	0.24	2000	0.6	5.0	5.0		ECA2WHG4R7()	200	500
	10	12.5	20	75	0.24	2000	0.6	5.0	5.0		ECA2WHG100()	200	500
	22	16	25	115	0.24	2000	0.8	7.5	7.5		ECA2WHG220()	100	250
	33	16	31.5	155	0.24	2000	0.8	7.5			ECA2WHG330	100	

- When requesting taped product, please put the letter "B" or "i" between the "()". Lead wire pitch *B=5 mm, 7.5 mm, i=2.5 mm.
- Please refer to the page of "Taping Dimensions".

Radial Lead Type

Series: **HD** Type: **A**



■ Features

- Endurance : 105 °C 1000 h to 2000 h
- Minaturize, Higher Capacitance :
1 Size Minaturized Product of Current A-NHG
- RoHS directive compliant

■ Specifications

Category Temp. Range	-55 °C to +105 °C	
Rated W.V. Range	10 V.DC to 50 V.DC	
Nominal Cap. Range	2.2 μF to 22000 μF	
Capacitance Tolerance	±20 % (120 Hz/+20 °C)	
DC Leakage Current	$I \leq 0.01 CV$ or 3 (μA) After 2 minutes (Which is greater)	
tan δ	Please see the attached standard products list	
Endurance	After following life test with DC voltage and +105 °C±2 °C ripple current value applied (The sum of DC and ripple peak voltage shall not exceed the rated working voltage), When the capacitors are restored to 20 °C, the capacitors shall meet the limits specified below. Duration : φ5 to φ8=1000 hours, φ10 to φ18=2000 hours	
	Capacitance change	±20 % of initial measured value
	tan δ	≤ 200 % of initial specified value
	DC leakage current	≤ initial specified value
Shelf Life	After storage for 1000 hours at +105 °C±2 °C with no voltage applied and then being stabilized at +20 °C, capacitors shall meet the limits specified in Endurance. (With voltage treatment)	

■ Frequency correction factor for ripple current

W.V.(V.DC)	Cap. (μF)	Frequency (Hz)				
		60	120	1 k	10 k	100 k
10 to 50	2.2 to 33	0.75	1.00	1.55	1.80	2.00
	47 to 470	0.80	1.00	1.35	1.50	1.50
	1000 to 22000	0.85	1.00	1.10	1.15	1.15

■ Dimensions in mm (not to scale)

(Unit : mm)



Design and specifications are each subject to change without notice. Ask factory for the current technical specifications before purchase and/or use.
 Should a safety concern arise regarding this product, please be sure to contact us immediately.

02 May. 2014

Standard Products

Endurance : 105 °C ϕ 5 to ϕ 8=1000 h, ϕ 10 to ϕ 18=2000 h

W.V. (V)	Cap. (\pm 20 %) (μ F)	Case size		Specification			Lead Length				Part No.	Min. Packaging Qty	
		Dia. (mm)	Length (mm)	Ripple Current (120 Hz) (+105 °C) (mA r.m.s.)	$\tan \delta$ (120 Hz) (+20 °C)	Endurance (hours)	Lead Dia. (mm)	Lead Space				Straight Leads (pcs)	Taping (pcs)
								Straight (mm)	Taping *B (mm)	Taping *H (mm)			
10	330	6.3	11.2	200	0.24	1000	0.5	2.5	5.0	2.5	EEUHD1A331()	200	2000
	470	8	11.5	250	0.24	1000	0.6	3.5	5.0		EEUHD1A471()	200	1000
	1000	10	12.5	460	0.24	2000	0.6	5.0	5.0		EEUHD1A102()	200	500
	2200	10	16	760	0.26	2000	0.6	5.0	5.0		EEUHD1A222()	200	500
	4700	12.5	20	1260	0.30	2000	0.6	5.0	5.0		EEUHD1A472()	200	500
	6800	12.5	25	1570	0.34	2000	0.6	5.0	5.0		EEUHD1A682()	200	500
	10000	16	25	1890	0.42	2000	0.8	7.5	7.5		EEUHD1A103()	100	250
	15000	16	31.5	2180	0.52	2000	0.8	7.5			EEUHD1A153	100	
16	22000	18	35.5	2400	0.66	2000	0.8	7.5			EEUHD1A223	50	
	100	5	11	110	0.20	1000	0.5	2.0	5.0	2.5	EEUHD1C101()	200	2000
	220	6.3	11.2	180	0.20	1000	0.5	2.5	5.0	2.5	EEUHD1C221()	200	2000
	330	8	11.5	260	0.20	1000	0.6	3.5	5.0		EEUHD1C331()	200	1000
	470	8	11.5	310	0.20	1000	0.6	3.5	5.0		EEUHD1C471()	200	1000
	3300	12.5	20	1170	0.24	2000	0.6	5.0	5.0		EEUHD1C332()	200	500
	4700	12.5	25	1480	0.26	2000	0.6	5.0	5.0		EEUHD1C472()	200	500
	6800	16	25	1780	0.30	2000	0.8	7.5	7.5		EEUHD1C682()	100	250
	8200	16	25	1780	0.34	2000	0.8	7.5	7.5		EEUHD1C822()	100	250
	10000	16	31.5	2060	0.38	2000	0.8	7.5			EEUHD1C103	100	
25	15000	18	35.5	2210	0.48	2000	0.8	7.5			EEUHD1C153	50	
	47	5	11	91	0.16	1000	0.5	2.0	5.0	2.5	EEUHD1E470()	200	2000
	68	5	11	91	0.16	1000	0.5	2.0	5.0	2.5	EEUHD1E680()	200	2000
	100	6.3	11.2	130	0.16	1000	0.5	2.5	5.0	2.5	EEUHD1E101()	200	2000
	220	8	11.5	230	0.16	1000	0.6	3.5	5.0		EEUHD1E221()	200	1000
	330	8	11.5	310	0.16	1000	0.6	3.5	5.0		EEUHD1E331()	200	1000
	470	10	12.5	380	0.16	2000	0.6	5.0	5.0		EEUHD1E471()	200	500
	1000	10	16	680	0.16	2000	0.6	5.0	5.0		EEUHD1E102()	200	500
	2200	12.5	20	1090	0.18	2000	0.6	5.0	5.0		EEUHD1E222()	200	500
	3300	12.5	25	1400	0.20	2000	0.6	5.0	5.0		EEUHD1E332()	200	500
	4700	16	25	1750	0.22	2000	0.8	7.5	7.5		EEUHD1E472()	100	250
	5600	16	25	1750	0.24	2000	0.8	7.5	7.5		EEUHD1E562()	100	250
35	6800	16	31.5	2040	0.26	2000	0.8	7.5			EEUHD1E682	100	
	10000	18	35.5	2200	0.34	2000	0.8	7.5			EEUHD1E103	50	
	47	5	11	90	0.14	1000	0.5	2.0	5.0	2.5	EEUHD1V470()	200	2000
	100	6.3	11.2	150	0.14	1000	0.5	2.5	5.0	2.5	EEUHD1V101()	200	2000
	220	8	11.5	270	0.14	1000	0.6	3.5	5.0		EEUHD1V221()	200	1000
	330	10	12.5	350	0.14	2000	0.6	5.0	5.0		EEUHD1V331()	200	500
	470	10	16	460	0.14	2000	0.6	5.0	5.0		EEUHD1V471()	200	500
	680	10	16	460	0.14	2000	0.6	5.0	5.0		EEUHD1V681()	200	500
	2200	12.5	25	1260	0.16	2000	0.6	5.0	5.0		EEUHD1V222()	200	500
	3300	16	25	1610	0.18	2000	0.8	7.5	7.5		EEUHD1V332()	100	250
35	4700	16	31.5	1910	0.20	2000	0.8	7.5			EEUHD1V472	100	
	6800	18	35.5	2050	0.24	2000	0.8	7.5			EEUHD1V682	50	

· When requesting taped product, please put the letter "B" or "H" between the "()". Lead wire pitch *B=5 mm, 7.5 mm, H=2.5 mm.
 · Please refer to the page of "Taping Dimensions".

Standard Products

Endurance : 105 °C ϕ 5 to ϕ 8=1000 h, ϕ 10 to ϕ 18=2000 h

W.V. (V)	Cap. (\pm 20 %) (μ F)	Case size		Specification			Lead Length				Part No.	Min. Packaging Qty	
		Dia. (mm)	Length (mm)	Ripple Current (120 Hz) (+105 °C) (mA r.m.s.)	$\tan \delta$ (120 Hz) (+20 °C)	Endurance (hours)	Lead Dia. (mm)	Lead Space				Straight Leads (pcs)	Taping (pcs)
								Straight (mm)	Taping *B (mm)	Taping *H (mm)			
50	0.1	5	11	1.1	0.12	1000	0.5	2.0	5.0	2.5	EEUHD1HR10()***	200	2000
	0.22	5	11	2.3	0.12	1000	0.5	2.0	5.0	2.5	EEUHD1HR22()***	200	2000
	0.33	5	11	3.5	0.12	1000	0.5	2.0	5.0	2.5	EEUHD1HR33()***	200	2000
	0.47	5	11	5	0.12	1000	0.5	2.0	5.0	2.5	EEUHD1HR47()***	200	2000
	1	5	11	10	0.12	1000	0.5	2.0	5.0	2.5	EEUHD1H1R0()***	200	2000
	2.2	5	11	18	0.12	1000	0.5	2.0	5.0	2.5	EEUHD1H2R2()	200	2000
	3.3	5	11	22	0.12	1000	0.5	2.0	5.0	2.5	EEUHD1H3R3()	200	2000
	4.7	5	11	26	0.12	1000	0.5	2.0	5.0	2.5	EEUHD1H4R7()	200	2000
	10	5	11	39	0.12	1000	0.5	2.0	5.0	2.5	EEUHD1H100()	200	2000
	22	5	11	65	0.12	1000	0.5	2.0	5.0	2.5	EEUHD1H220()	200	2000
	33	5	11	90	0.12	1000	0.5	2.0	5.0	2.5	EEUHD1H330()	200	2000
	47	6.3	11.2	110	0.12	1000	0.5	2.5	5.0	2.5	EEUHD1H470()	200	2000
	68	6.3	11.2	110	0.12	1000	0.5	2.5	5.0	2.5	EEUHD1H680()	200	2000
	100	8	11.5	180	0.12	1000	0.6	3.5	5.0		EEUHD1H101()	200	1000
	220	10	12.5	300	0.12	2000	0.6	5.0	5.0		EEUHD1H221()	200	500
	330	10	16	410	0.12	2000	0.6	5.0	5.0		EEUHD1H331()	200	500
	470	10	20	530	0.12	2000	0.6	5.0	5.0		EEUHD1H471()	200	500
	560	16	15	650	0.12	2000	0.8	7.5	7.5		EEUHD1H561S()	100	250
	680	16	15	650	0.12	2000	0.8	7.5	7.5		EEUHD1H681S()	100	250
	1000	12.5	25	950	0.12	2000	0.6	5.0	5.0		EEUHD1H102()	200	500
2200	16	31.5	1470	0.14	2000	0.8	7.5			EEUHD1H222	100		
3300	18	35.5	1770	0.16	2000	0.8	7.5			EEUHD1H332	50		

· When requesting taped product, please put the letter "B" or "H" between the "()". Lead wire pitch *B=5 mm, 7.5 mm, H=2.5 mm.

· Please refer to the page of "Taping Dimensions".

*** Please kindly accept last shipment : 31/Mar/2015

Radial Lead Type

Series: **GA** Type: **A**

■ Features

- Endurance : 105 °C 1000 h
- RoHS directive compliant

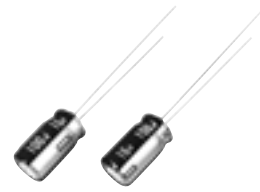

■ Specifications

Category Temp. Range	-55 °C to +105 °C	
Rated W.V. Range	10 V.DC to 50 V.DC	
Nominal Cap. Range	1.5 μF to 220 μF	
Capacitance Tolerance	±20 % (120 Hz/+20 °C)	
DC Leakage Current	$I \leq 0.01 CV$ or 3 (μA) After 2 minutes (Whichever is greater)	
tan δ	Please see the attached standard products list	
Endurance	After following life test with DC voltage and +105 °C±2 °C ripple current value applied (The sum of DC and ripple peak voltage shall not exceed the rated working voltage), for 1000 hours, when the capacitors are restored to 20 °C, the capacitors shall meet the limits specified below.	
	Capacitance change	±20 % of initial measured value
	tan δ	≤ 200 % of initial specified value
	DC leakage current	≤ initial specified value
Shelf Life	After storage for 1000 hours at +105 °C±2 °C with no voltage applied and then being stabilized at +20 °C, capacitors shall meet the limits specified in Endurance. (With voltage treatment)	

■ Frequency correction factor for ripple current

W.V.(V.DC)	Cap (μF)	Frequency (Hz)				
		60	120	1 k	10 k	100 k to
10 to 50	1.5 to 220	0.85	1.00	1.30	1.40	1.55

■ Dimensions in mm(not to scale)

(Unit : mm)

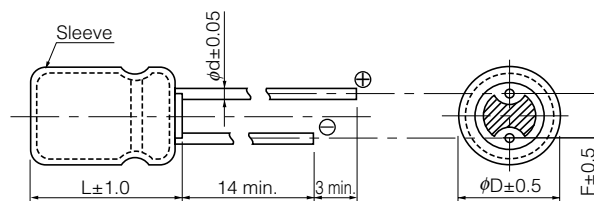

	4	5	6.3	8
Body Dia. φD	4	5	6.3	8
Lead Dia. φd	0.45	0.45	0.45	0.45
Lead space F	1.5	2.0	2.5	2.5

Standard Products

Endurance : 105 °C 1000 h

W.V. (V)	Cap. (±20 %) (μF)	Case size		Specification			Lead Length			Part No.	Min. Packaging Qty		
		Dia. (mm)	Length (mm)	Ripple Current (120 Hz) (+105 °C) (mA r.m.s.)	tan δ (120 Hz) (+20 °C)	Endurance (hours)	Lead Dia. (mm)	Lead Space			Straight Leads (pcs)	Taping (pcs)	
								Straight (mm)	Taping *B (mm)				Taping *H (mm)
10	22	4	7	30	0.22	1000	0.45	1.5	5.0	2.5	EEAGA1A220()	200	2000
	33	5	7	50	0.22	1000	0.45	2.0	5.0	2.5	EEAGA1A330()	200	2000
	47	6.3	7	65	0.22	1000	0.45	2.5	5.0	2.5	EEAGA1A470()	200	2000
	68	6.3	7	75	0.22	1000	0.45	2.5	5.0	2.5	EEAGA1A680()	200	2000
	100	6.3	7	110	0.22	1000	0.45	2.5	5.0	2.5	EEAGA1A101()	200	2000
	220	8	7	160	0.22	1000	0.45	2.5	5.0	2.5	EEAGA1A221()	200	1000
16	10	4	7	30	0.18	1000	0.45	1.5	5.0	2.5	EEAGA1C100()	200	2000
	15	4	7	33	0.18	1000	0.45	1.5	5.0	2.5	EEAGA1C150()	200	2000
	22	5	7	50	0.18	1000	0.45	2.0	5.0	2.5	EEAGA1C220()	200	2000
	33	6.3	7	65	0.18	1000	0.45	2.5	5.0	2.5	EEAGA1C330()	200	2000
	47	6.3	7	77	0.18	1000	0.45	2.5	5.0	2.5	EEAGA1C470()	200	2000
	100	8	7	120	0.18	1000	0.45	2.5	5.0	2.5	EEAGA1C101()	200	1000
25	10	4	7	33	0.16	1000	0.45	1.5	5.0	2.5	EEAGA1E100()	200	2000
	15	5	7	45	0.16	1000	0.45	2.0	5.0	2.5	EEAGA1E150()	200	2000
	22	5	7	50	0.16	1000	0.45	2.0	5.0	2.5	EEAGA1E220()	200	2000
	33	6.3	7	75	0.16	1000	0.45	2.5	5.0	2.5	EEAGA1E330()	200	2000
	68	8	7	100	0.16	1000	0.45	2.5	5.0	2.5	EEAGA1E680()	200	1000
35	6.8	4	7	33	0.13	1000	0.45	1.5	5.0	2.5	EEAGA1V6R8()	200	2000
	10	5	7	35	0.13	1000	0.45	2.0	5.0	2.5	EEAGA1V100()	200	2000
	15	6.3	7	50	0.13	1000	0.45	2.5	5.0	2.5	EEAGA1V150()	200	2000
	22	6.3	7	70	0.13	1000	0.45	2.5	5.0	2.5	EEAGA1V220()	200	2000
	47	8	7	96	0.13	1000	0.45	2.5	5.0	2.5	EEAGA1V470()	200	1000
50	0.1	4	7	1.1	0.10	1000	0.45	1.5	5.0	2.5	EEAGA1HR10()***	200	2000
	0.15	4	7	1.7	0.10	1000	0.45	1.5	5.0	2.5	EEAGA1HR15()***	200	2000
	0.22	4	7	2.3	0.10	1000	0.45	1.5	5.0	2.5	EEAGA1HR22()***	200	2000
	0.33	4	7	3.5	0.10	1000	0.45	1.5	5.0	2.5	EEAGA1HR33()***	200	2000
	0.47	4	7	5	0.10	1000	0.45	1.5	5.0	2.5	EEAGA1HR47()***	200	2000
	0.68	4	7	7	0.10	1000	0.45	1.5	5.0	2.5	EEAGA1HR68()***	200	2000
	1	4	7	10	0.10	1000	0.45	1.5	5.0	2.5	EEAGA1H1R0()***	200	2000
	1.5	4	7	16	0.10	1000	0.45	1.5	5.0	2.5	EEAGA1H1R5()	200	2000
	2.2	4	7	18	0.10	1000	0.45	1.5	5.0	2.5	EEAGA1H2R2()	200	2000
	3.3	4	7	22	0.10	1000	0.45	1.5	5.0	2.5	EEAGA1H3R3()	200	2000
	4.7	4	7	26	0.10	1000	0.45	1.5	5.0	2.5	EEAGA1H4R7()	200	2000
	6.8	5	7	35	0.10	1000	0.45	2.0	5.0	2.5	EEAGA1H6R8()	200	2000
	10	6.3	7	39	0.10	1000	0.45	2.5	5.0	2.5	EEAGA1H100()	200	2000
	15	6.3	7	55	0.10	1000	0.45	2.5	5.0	2.5	EEAGA1H150()	200	2000
22	8	7	70	0.10	1000	0.45	2.5	5.0	2.5	EEAGA1H220()	200	1000	
33	8	7	91	0.10	1000	0.45	2.5	5.0	2.5	EEAGA1H330()	200	1000	

· When requesting taped product, please put the letter "B" or "H" between the "()". Lead wire pitch *B=5 mm, H=2.5 mm.

Suffix "BQ" for ø8×7, 5mm pitch products

· Please refer to the page of "Taping Dimensions".

*** Please kindly accept last shipment : 31/Mar/2015

Radial Lead Type

Series: **GA(Bi-polar)** Type: **A**

■ Features

- Endurance : 105 °C 1000 h to 2000 h
- RoHS directive compliant



■ Specifications

Category Temp. Range	-40 °C to +105 °C
Rated W.V. Range	6.3 V.DC to 50 V.DC
Nominal Cap. Range	2.2 μF to 330 μF
Capacitance Tolerance	±20 % (120 Hz/+20 °C)
DC Leakage Current	$I \leq 0.03 CV + 3 (\mu A)$ After 2 minutes or $I \leq 0.03 CV$ or 3 (μA) After 5 minutes (Whichever is greater)
tan δ	Please see the attached standard products list
Endurance	After following life test of DC working voltage at +105 °C±2 °C when the capacitors are restored to 20 °C, the capacitors shall meet the following limits. Duration φ5 to φ8 : 1000 hours (500 hours for each polarity) φ10 : 2000 hours (1000 hours for each polarity)
	Capacitance change ± 20% of initial measured value
	tan δ ≤ 200 % of initial specified value
	DC leakage current ≤ initial specified value
Shelf Life	After storage for 1000 hours at +105 °C±2 °C with no voltage applied and then being stabilized at +20 °C, capacitors shall meet the limits specified in Endurance. (With voltage treatment)

■ Frequency correction factor for ripple current

Correction factor	Frequency (Hz)			
	50, 60	120	1 k	10 k to
	0.70	1.00	1.30	1.70

■ Dimensions in mm (not to scale)

(Unit : mm)



■ Standard Products (Bi-polar)

Endurance : 105 °C ϕ 5 to ϕ 8=1000 h (500 h for each polarity), ϕ 10=2000 h (1000 h for each polarity)

W.V. (V)	Cap. (\pm 20 %) (μ F)	Case size		Specification		Lead Length			Part No.	Min. Packaging Q'ty		
		Dia. (mm)	Length (mm)	Ripple Current (120 Hz) (+105 °C) (mA r.m.s.)	$\tan \delta$ (120 Hz) (+20 °C)	Lead Dia. (mm)	Lead Space			Straight Leads (pcs)	Taping (pcs)	
							Straight (mm)	Taping *B (mm)				Taping *i (mm)
6.3	100	6.3	11.2	130	0.30	0.5	2.5	5.0	2.5	ECA0JEN101()	200	2000
	330	8	11.5	250	0.30	0.6	3.5	5.0		ECA0JEN331()	200	1000
10	47	5	11	90	0.24	0.5	2.0	5.0	2.5	ECA1AEN470()	200	2000
16	10	5	11	40	0.20	0.5	2.0	5.0	2.5	ECA1CEN100()	200	2000
	22	5	11	60	0.20	0.5	2.0	5.0	2.5	ECA1CEN220()	200	2000
	33	5	11	80	0.20	0.5	2.0	5.0	2.5	ECA1CEN330()	200	2000
	47	6.3	11.2	100	0.20	0.5	2.5	5.0	2.5	ECA1CEN470()	200	2000
25	10	5	11	45	0.15	0.5	2.0	5.0	2.5	ECA1EEN100()	200	2000
	22	6.3	11.2	60	0.15	0.5	2.5	5.0	2.5	ECA1EEN220()	200	2000
	33	6.3	11.2	90	0.15	0.5	2.5	5.0	2.5	ECA1EEN330()	200	2000
	47	6.3	11.2	110	0.15	0.5	2.5	5.0	2.5	ECA1EEN470()	200	2000
	100	8	11.5	180	0.15	0.6	3.5	5.0		ECA1EEN101()	200	1000
35	33	8	11.5	100	0.15	0.6	3.5	5.0		ECA1VEN330()	200	1000
	100	10	16	230	0.15	0.6	5.0	5.0		ECA1VEN101()	200	500
50	0.47	5	11	10	0.15	0.5	2.0	5.0	2.5	ECA1HENR47()***	200	2000
	1	5	11	10	0.15	0.5	2.0	5.0	2.5	ECA1HEN010()***	200	2000
	2.2	5	11	18	0.15	0.5	2.0	5.0	2.5	ECA1HEN2R2()	200	2000
	3.3	5	11	25	0.15	0.5	2.0	5.0	2.5	ECA1HEN3R3()	200	2000
	4.7	5	11	30	0.15	0.5	2.0	5.0	2.5	ECA1HEN4R7()	200	2000
	10	6.3	11.2	50	0.15	0.5	2.5	5.0	2.5	ECA1HEN100()	200	2000
	22	8	11.5	90	0.15	0.6	3.5	5.0		ECA1HEN220()	200	1000
	33	8	11.5	110	0.15	0.6	3.5	5.0		ECA1HEN330()	200	1000
	47	10	12.5	140	0.15	0.6	5.0	5.0		ECA1HEN470()	200	500
	100	10	20	250	0.15	0.6	5.0	5.0		ECA1HEN101()	200	500

· When requesting taped product, please put the letter "B" or "i" between the "()". Lead wire pitch *B=5 mm, i=2.5 mm.

· Please refer to the page of "Taping Dimensions".

*** Please kindly accept last shipment : 31/Mar/2015

Radial Lead Type

Series: **M** Type: **A**

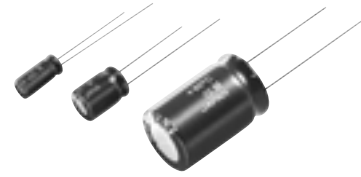

■ Features

- Endurance : 85 °C 2000 h
- Smaller than series SU
- RoHS directive compliant

■ Specifications

Category Temp. Range	-40 °C to + 85 °C	-25 °C to +85 °C
Rated W.V. Range	6.3 V.DC to 100 V.DC	160 V.DC to 450 V.DC
Nominal Cap. Range	2.2 μF to 22000 μF	1 μF to 470 μF
Capacitance Tolerance	±20 % (120 Hz/+20 °C)	
DC Leakage Current	$I \leq 0.01 CV$ or $3 (\mu A)$ After 2 minutes (Whichever is greater)	$I \leq 0.06 CV + 10 (\mu A)$ After 2 minutes
tan δ	Please see the attached standard products list	
Endurance	After applying rated working voltage for 2000 hours at +85°C±2 °C, when the capacitors are restored to 20 °C, capacitors shall meet the following limits.	
	Capacitance change	±20 % of initial measured value
	tan δ	≤150 % of initial specified value
	DC leakage current	≤initial specified value
Shelf Life	After storage for 1000 hours at +85 °C±2 °C with no voltage applied and then being stabilized at +20 °C, capacitors shall meet the limits specified in Endurance. (With voltage treatment)	

■ Frequency correction factor for ripple current

Correction factor	Frequency (Hz)			
	50, 60	120	1 k	10 k to
	0.70	1.00	1.30	1.70

■ Dimensions in mm (not to scale)

(Unit : mm)



Standard Products

Endurance : 85 °C 2000 h

W.V. (V)	Cap. (±20 %) (μF)	Case size		Specification		Lead Length				Part No.	Min. Packaging Q'ty	
		Dia. (mm)	Length (mm)	Ripple Current (120 Hz) (+85 °C) (mA r.m.s.)	tan δ (120 Hz) (+20 °C)	Lead Dia. (mm)	Lead Space				Straight Leads (pcs)	Taping (pcs)
							Straight (mm)	Taping *B (mm)	Taping *i (mm)			
6.3	220	5	11	240	0.28	0.5	2.0	5.0	2.5	ECA0JM221()	200	2000
	470	6.3	11.2	380	0.28	0.5	2.5	5.0	2.5	ECA0JM471()	200	2000
	1000	8	11.5	580	0.28	0.6	3.5	5.0		ECA0JM102()	200	1000
	2200	10	16	890	0.30	0.6	5.0	5.0		ECA0JM222()	200	500
	3300	10	20	1020	0.32	0.6	5.0	5.0		ECA0JM332()	200	500
	4700	12.5	20	1170	0.34	0.6	5.0	5.0		ECA0JM472()	200	500
	6800	12.5	25	1270	0.38	0.6	5.0	5.0		ECA0JM682()	200	500
	10000	16	25	1450	0.46	0.8	7.5	7.5		ECA0JM103()	100	250
	15000	16	31.5	1700	0.56	0.8	7.5			ECA0JM153	100	
22000	18	35.5	1900	0.70	0.8	7.5			ECA0JM223	50		
10	330	6.3	11.2	330	0.24	0.5	2.5	5.0	2.5	ECA1AM331()	200	2000
	1000	10	12.5	630	0.24	0.6	5.0	5.0		ECA1AM102()	200	500
	2200	10	20	920	0.26	0.6	5.0	5.0		ECA1AM222()	200	500
	3300	12.5	20	1090	0.28	0.6	5.0	5.0		ECA1AM332()	200	500
	4700	12.5	25	1200	0.30	0.6	5.0	5.0		ECA1AM472()	200	500
	6800	16	25	1400	0.34	0.8	7.5	7.5		ECA1AM682()	100	250
	10000	16	31.5	1600	0.42	0.8	7.5			ECA1AM103	100	
	15000	18	35.5	1850	0.52	0.8	7.5			ECA1AM153	50	
16	10	5	11	30	0.20	0.5	2.0	5.0	2.5	ECA1CM100()	200	2000
	22	5	11	75	0.20	0.5	2.0	5.0	2.5	ECA1CM220()	200	2000
	33	5	11	110	0.20	0.5	2.0	5.0	2.5	ECA1CM330()	200	2000
	47	5	11	130	0.20	0.5	2.0	5.0	2.5	ECA1CM470()	200	2000
	100	5	11	180	0.20	0.5	2.0	5.0	2.5	ECA1CM101()	200	2000
	220	6.3	11.2	280	0.20	0.5	2.5	5.0	2.5	ECA1CM221()	200	2000
	470	8	11.5	440	0.20	0.6	3.5	5.0		ECA1CM471()	200	1000
	1000	10	16	680	0.20	0.6	5.0	5.0		ECA1CM102()	200	500
	2200	12.5	20	1000	0.22	0.6	5.0	5.0		ECA1CM222()	200	500
	3300	12.5	25	1200	0.24	0.6	5.0	5.0		ECA1CM332()	200	500
	4700	16	25	1360	0.26	0.8	7.5	7.5		ECA1CM472()	100	250
	6800	16	31.5	1600	0.30	0.8	7.5			ECA1CM682	100	
10000	18	35.5	1800	0.38	0.8	7.5			ECA1CM103	50		
25	100	6.3	11.2	180	0.16	0.5	2.5	5.0	2.5	ECA1EM101()	200	2000
	330	8	11.5	390	0.16	0.6	3.5	5.0		ECA1EM331()	200	1000
	470	10	12.5	480	0.16	0.6	5.0	5.0		ECA1EM471()	200	500
	1000	10	20	850	0.16	0.6	5.0	5.0		ECA1EM102()	200	500
	2200	12.5	25	1200	0.18	0.6	5.0	5.0		ECA1EM222()	200	500
	3300	16	25	1300	0.20	0.8	7.5	7.5		ECA1EM332()	100	250
	4700	16	31.5	1500	0.22	0.8	7.5			ECA1EM472	100	
6800	18	35.5	1750	0.26	0.8	7.5			ECA1EM682	50		
35	47	5	11	130	0.14	0.5	2.0	5.0	2.5	ECA1VM470()	200	2000
	100	6.3	11.2	210	0.14	0.5	2.5	5.0	2.5	ECA1VM101()	200	2000
	220	8	11.5	350	0.14	0.6	3.5	5.0		ECA1VM221()	200	1000

· When requesting taped product, please put the letter "B" or "i" between the "()". Lead wire pitch *B=5 mm, 7.5 mm, i=2.5 mm.
· Please refer to the page of "Taping Dimensions".

Standard Products

Endurance : 85 °C 2000 h

W.V.	Cap. (±20 %)	Case size		Specification		Lead Length				Part No.	Min. Packaging Q'ty	
		Dia.	Length	Ripple Current (120 Hz) (+85 °C) (mA r.m.s.)	tan δ (120 Hz) (+20 °C)	Lead Dia.	Lead Space				Straight Leads	Taping
							Straight	Taping *B	Taping *i			
(V)	(μF)	(mm)	(mm)	(mA r.m.s.)	(mm)	(mm)	(mm)	(mm)			(pcs)	(pcs)
35	330	10	12.5	440	0.14	0.6	5.0	5.0		ECA1VM331()	200	500
	470	10	16	550	0.14	0.6	5.0	5.0		ECA1VM471()	200	500
	1000	12.5	20	900	0.14	0.6	5.0	5.0		ECA1VM102()	200	500
	2200	16	25	1250	0.16	0.8	7.5	7.5		ECA1VM222()	100	250
	3300	16	31.5	1400	0.18	0.8	7.5			ECA1VM332	100	
	4700	18	35.5	1600	0.20	0.8	7.5			ECA1VM472	50	
50	0.1	5	11	1.3	0.12	0.5	2.0	5.0	2.5	ECA1HM0R1()***	200	2000
	0.22	5	11	2.9	0.12	0.5	2.0	5.0	2.5	ECA1HMR22()***	200	2000
	0.33	5	11	4.4	0.12	0.5	2.0	5.0	2.5	ECA1HMR33()***	200	2000
	0.47	5	11	5	0.12	0.5	2.0	5.0	2.5	ECA1HMR47()***	200	2000
	1	5	11	10	0.12	0.5	2.0	5.0	2.5	ECA1HM010()***	200	2000
	2.2	5	11	20	0.12	0.5	2.0	5.0	2.5	ECA1HM2R2()	200	2000
	3.3	5	11	35	0.12	0.5	2.0	5.0	2.5	ECA1HM3R3()	200	2000
	4.7	5	11	45	0.12	0.5	2.0	5.0	2.5	ECA1HM4R7()	200	2000
	10	5	11	65	0.12	0.5	2.0	5.0	2.5	ECA1HM100()	200	2000
	22	5	11	100	0.12	0.5	2.0	5.0	2.5	ECA1HM220()	200	2000
	33	5	11	110	0.12	0.5	2.0	5.0	2.5	ECA1HM330()	200	2000
	47	6.3	11.2	130	0.12	0.5	2.5	5.0	2.5	ECA1HM470()	200	2000
	100	8	11.5	250	0.12	0.6	3.5	5.0		ECA1HM101()	200	1000
	220	10	12.5	400	0.12	0.6	5.0	5.0		ECA1HM221()	200	500
	330	10	16	500	0.12	0.6	5.0	5.0		ECA1HM331()	200	500
	470	10	20	650	0.12	0.6	5.0	5.0		ECA1HM471()	200	500
1000	12.5	25	1050	0.12	0.6	5.0	5.0		ECA1HM102()	200	500	
2200	16	31.5	1300	0.14	0.8	7.5			ECA1HM222	100		
3300	18	35.5	1500	0.16	0.8	7.5			ECA1HM332	50		
63	10	5	11	70	0.11	0.5	2.0	5.0	2.5	ECA1JM100()	200	2000
	22	5	11	105	0.11	0.5	2.0	5.0	2.5	ECA1JM220()	200	2000
	33	6.3	11.2	130	0.11	0.5	2.5	5.0	2.5	ECA1JM330()	200	2000
	47	6.3	11.2	160	0.11	0.5	2.5	5.0	2.5	ECA1JM470()	200	2000
	100	8	11.5	270	0.11	0.6	3.5	5.0		ECA1JM101()	200	1000
	220	10	16	450	0.11	0.6	5.0	5.0		ECA1JM221()	200	500
	330	10	20	550	0.11	0.6	5.0	5.0		ECA1JM331()	200	500
	470	12.5	20	750	0.11	0.6	5.0	5.0		ECA1JM471()	200	500
	1000	16	25	1100	0.11	0.8	7.5	7.5		ECA1JM102()	100	250
	2200	18	35.5	1400	0.13	0.8	7.5			ECA1JM222	50	
100	0.47	5	11	10	0.10	0.5	2.0	5.0	2.5	ECA2AMR47()***	200	2000
	1	5	11	20	0.10	0.5	2.0	5.0	2.5	ECA2AM010()***	200	2000
	2.2	5	11	30	0.10	0.5	2.0	5.0	2.5	ECA2AM2R2()	200	2000
	3.3	5	11	40	0.10	0.5	2.0	5.0	2.5	ECA2AM3R3()	200	2000
	4.7	5	11	50	0.10	0.5	2.0	5.0	2.5	ECA2AM4R7()	200	2000
	10	5	11	70	0.10	0.5	2.0	5.0	2.5	ECA2AM100()	200	2000
	22	6.3	11.2	115	0.10	0.5	2.5	5.0	2.5	ECA2AM220()	200	2000

· When requesting taped product, please put the letter "B" or "I" between the "()". Lead wire pitch *B=5 mm, 7.5 mm, i=2.5 mm.

· Please refer to the page of "Taping Dimensions".

*** Please kindly accept last shipment : 31/Mar/2015

Design and specifications are each subject to change without notice. Ask factory for the current technical specifications before purchase and/or use.
Should a safety concern arise regarding this product, please be sure to contact us immediately.

02 May, 2014

Standard Products

Endurance : 85 °C 2000 h

W.V. (V)	Cap. (±20 %) (μF)	Case size		Specification		Lead Length				Part No.	Min. Packaging Q'ty	
		Dia. (mm)	Length (mm)	Ripple Current (120 Hz) (+85 °C) (mA r.m.s.)	tan δ (120 Hz) (+20 °C)	Lead Dia. (mm)	Lead Space				Straight Leads (pcs)	Taping (pcs)
							Straight (mm)	Taping *B (mm)	Taping *i (mm)			
100	33	8	11.5	145	0.10	0.6	3.5	5.0		ECA2AM330()	200	1000
	47	8	11.5	180	0.10	0.6	3.5	5.0		ECA2AM470()	200	1000
	100	10	16	350	0.10	0.6	5.0	5.0		ECA2AM101()	200	500
	220	12.5	20	550	0.10	0.6	5.0	5.0		ECA2AM221()	200	500
	330	12.5	25	700	0.10	0.6	5.0	5.0		ECA2AM331()	200	500
	470	16	25	900	0.10	0.8	7.5	7.5		ECA2AM471()	100	250
	1000	18	35.5	1300	0.10	0.8	7.5			ECA2AM102	50	
160	1	6.3	11.2	36	0.16	0.5	2.5	5.0	2.5	ECA2CM010()	200	2000
	2.2	6.3	11.2	53	0.16	0.5	2.5	5.0	2.5	ECA2CM2R2()	200	2000
	3.3	6.3	11.2	66	0.16	0.5	2.5	5.0	2.5	ECA2CM3R3()	200	2000
	4.7	6.3	11.2	78	0.16	0.5	2.5	5.0	2.5	ECA2CM4R7()	200	2000
	10	10	12.5	105	0.16	0.6	5.0	5.0		ECA2CM100()	200	500
	22	10	16	175	0.16	0.6	5.0	5.0		ECA2CM220()	200	500
	33	10	20	235	0.16	0.6	5.0	5.0		ECA2CM330()	200	500
	47	12.5	20	320	0.16	0.6	5.0	5.0		ECA2CM470()	200	500
	100	12.5	25	515	0.16	0.6	5.0	5.0		ECA2CM101()	200	500
	220	16	31.5	830	0.16	0.8	7.5			ECA2CM221	100	
	330	18	31.5	1090	0.16	0.8	7.5			ECA2CM331	50	
470	18	40	1440	0.16	0.8	7.5			ECA2CM471	50		
200	1	6.3	11.2	34	0.18	0.5	2.5	5.0	2.5	ECA2DM010()	200	2000
	2.2	6.3	11.2	50	0.18	0.5	2.5	5.0	2.5	ECA2DM2R2()	200	2000
	3.3	6.3	11.2	62	0.18	0.5	2.5	5.0	2.5	ECA2DM3R3()	200	2000
	4.7	8	11.5	86	0.18	0.6	3.5	5.0		ECA2DM4R7()	200	1000
	10	10	12.5	100	0.18	0.6	5.0	5.0		ECA2DM100()	200	500
	22	10	20	180	0.18	0.6	5.0	5.0		ECA2DM220()	200	500
	33	10	20	220	0.18	0.6	5.0	5.0		ECA2DM330()	200	500
	47	12.5	20	300	0.18	0.6	5.0	5.0		ECA2DM470()	200	500
	100	16	25	475	0.18	0.8	7.5	7.5		ECA2DM101()	100	250
	220	18	31.5	835	0.18	0.8	7.5			ECA2DM221	50	
330	18	40	1140	0.18	0.8	7.5			ECA2DM331	50		
250	1	6.3	11.2	34	0.18	0.5	2.5	5.0	2.5	ECA2EM010()	200	2000
	2.2	6.3	11.2	50	0.18	0.5	2.5	5.0	2.5	ECA2EM2R2()	200	2000
	3.3	8	11.5	72	0.18	0.6	3.5	5.0		ECA2EM3R3()	200	1000
	4.7	8	11.5	86	0.18	0.6	3.5	5.0		ECA2EM4R7()	200	1000
	10	10	16	110	0.18	0.6	5.0	5.0		ECA2EM100()	200	500
	22	10	20	180	0.18	0.6	5.0	5.0		ECA2EM220()	200	500
	33	12.5	20	250	0.18	0.6	5.0	5.0		ECA2EM330()	200	500
	47	12.5	25	330	0.18	0.6	5.0	5.0		ECA2EM470()	200	500
	100	16	31.5	530	0.18	0.8	7.5			ECA2EM101	100	
220	18	40	930	0.18	0.8	7.5			ECA2EM221	50		
350	1	6.3	11.2	32	0.20	0.5	2.5	5.0	2.5	ECA2VM010()	200	2000
	2.2	8	11.5	55	0.20	0.6	3.5	5.0		ECA2VM2R2()	200	1000

· When requesting taped product, please put the letter "B" or "i" between the "()". Lead wire pitch *B=5 mm, 7.5 mm, i=2.5 mm.
· Please refer to the page of "Taping Dimensions".

Design and specifications are each subject to change without notice. Ask factory for the current technical specifications before purchase and/or use.
Should a safety concern arise regarding this product, please be sure to contact us immediately.

02 May, 2014

■ Standard Products

Endurance : 85 °C 2000 h

W.V. (V)	Cap. (±20 %) (μF)	Case size		Specification		Lead Length			Part No.	Min. Packaging Q'ty		
		Dia. (mm)	Length (mm)	Ripple Current (120 Hz) (+85 °C) (mA r.m.s.)	tan δ (120 Hz) (+20 °C)	Lead Dia. (mm)	Lead Space			Straight Leads (pcs)	Taping (pcs)	
							Straight (mm)	Taping *B (mm)				Taping *i (mm)
350	3.3	8	11.5	60	0.20	0.6	3.5	5.0		ECA2VM3R3()	200	1000
	4.7	10	12.5	65	0.20	0.6	5.0	5.0		ECA2VM4R7()	200	500
	10	10	20	115	0.20	0.6	5.0	5.0		ECA2VM100()	200	500
	22	12.5	20	195	0.20	0.6	5.0	5.0		ECA2VM220()	200	500
	33	16	25	300	0.20	0.8	7.5	7.5		ECA2VM330()	100	250
	47	16	25	325	0.20	0.8	7.5	7.5		ECA2VM470()	100	250
	100	18	31.5	535	0.20	0.8	7.5			ECA2VM101	50	
400	1	6.3	11.2	32	0.20	0.5	2.5	5.0	2.5	ECA2GM010()	200	2000
	2.2	8	11.5	50	0.20	0.6	3.5	5.0		ECA2GM2R2()	200	1000
	3.3	10	12.5	54	0.20	0.6	5.0	5.0		ECA2GM3R3()	200	500
	4.7	10	16	72	0.20	0.6	5.0	5.0		ECA2GM4R7()	200	500
	10	10	20	115	0.20	0.6	5.0	5.0		ECA2GM100()	200	500
	22	12.5	25	215	0.20	0.6	5.0	5.0		ECA2GM220()	200	500
	33	16	25	275	0.20	0.8	7.5	7.5		ECA2GM330()	100	250
	47	16	31.5	350	0.20	0.8	7.5			ECA2GM470	100	
450	1	8	11.5	37	0.20	0.6	3.5	5.0		ECA2WM010()	200	1000
	2.2	10	12.5	44	0.20	0.6	5.0	5.0		ECA2WM2R2()	200	500
	3.3	10	16	60	0.20	0.6	5.0	5.0		ECA2WM3R3()	200	500
	4.7	10	20	79	0.20	0.6	5.0	5.0		ECA2WM4R7()	200	500
	10	12.5	20	130	0.20	0.6	5.0	5.0		ECA2WM100()	200	500
	22	16	25	210	0.20	0.8	7.5	7.5		ECA2WM220()	100	250
	33	16	31.5	285	0.20	0.8	7.5			ECA2WM330	100	

- When requesting taped product, please put the letter "B" or "i" between the "()". Lead wire pitch *B=5 mm, 7.5 mm, i=2.5 mm.
- Please refer to the page of "Taping Dimensions".

Radial Lead Type

Series: **SU(Bi-polar)** Type: **A**



■ Features

- Endurance : 85 °C 2000 h
- RoHS directive compliant

■ Specifications

Category Temp. Range	-40 °C to +85 °C		
Rated W.V. Range	6.3 V.DC to 50 V.DC		
Nominal Cap. Range	2.2 μF to 6800 μF		
Capacitance Tolerance	±20 % (120 Hz/+20 °C)		
DC Leakage Current	$I \leq 0.03 CV + 3$ (μA) After 5 minutes		
tan δ	Please see the attached standard products list.		
Endurance	After 2000 hours application of DC working voltage (1000 hours for each polarity) at +85 °C±2 °C, when the capacitors are restored to 20 °C, the capacitors shall meet the following limits.		
	Capacitance change	± 20 % of initial measured value	
	tan δ	≤ 150 % of initial specified value	
	DC leakage current	≤ initial specified value	
Shelf Life	After storage for 1000 hours at +85 °C±2 °C with no voltage applied and then being stabilized at +20 °C capacitors shall meet the limits specified in Endurance. (With voltage treatment)		

■ Frequency correction factor for ripple current

	Frequency (Hz)			
	50, 60	120	1 k	10 k to
Correction factor	0.70	1.00	1.30	1.70

■ Dimensions in mm (not to scale)

(Unit : mm)



Design and specifications are each subject to change without notice. Ask factory for the current technical specifications before purchase and/or use. Should a safety concern arise regarding this product, please be sure to contact us immediately.

02 May. 2014

■ Standard Products (Bi-polar)

Endurance: 85 °C 2000 h (1000 hours for each polarity)

W.V. (V)	Cap. (±20 %) (μF)	Case size		Specification		Lead Length			Part No.	Min. Packaging Qty		
		Dia. (mm)	Length (mm)	Ripple Current (120 Hz) (+85 °C) (mA r.m.s.)	tan δ (120 Hz) (+20 °C) (Ω)	Lead Dia. (mm)	Lead Space			Straight Leads (pcs)	Taping (pcs)	
							Straight (mm)	Taping *B (mm)				Taping *i (mm)
6.3	330	8	11.5	250	0.30	0.6	3.5	5.0		ECEA0JN331U()	200	1000
	470	10	12.5	310	0.30	0.6	5.0	5.0		ECEA0JN471X()	200	500
	1000	10	20	430	0.30	0.6	5.0	5.0		ECEA0JN102U()	200	500
	2200	12.5	25	660	0.32	0.6	5.0	5.0		ECEA0JN222U()	200	500
	3300	16	25	760	0.34	0.8	7.5	7.5		ECEA0JN332U()	100	250
	4700	16	31.5	1170	0.36	0.8	7.5			ECEA0JN472U	100	
	6800	18	35.5	1450	0.40	0.8	7.5			ECEA0JN682U	50	
10	47	5	11	90	0.25	0.5	2.0	5.0	2.5	ECEA1AN470U()	200	2000
	100	6.3	11.2	130	0.25	0.5	2.5	5.0	2.5	ECEA1AN101X()	200	2000
	220	8	11.5	200	0.25	0.6	3.5	5.0		ECEA1AN221U()	200	1000
	330	10	16	280	0.25	0.6	5.0	5.0		ECEA1AN331U()	200	500
	470	10	16	340	0.25	0.6	5.0	5.0		ECEA1AN471U()	200	500
	1000	12.5	20	470	0.25	0.6	5.0	5.0		ECEA1AN102X()	200	500
	2200	16	25	690	0.27	0.8	7.5	7.5		ECEA1AN222U()	100	250
	3300	16	31.5	1090	0.29	0.8	7.5			ECEA1AN332U	100	
16	4700	18	35.5	1200	0.31	0.8	7.5			ECEA1AN472U	50	
	10	5	11	40	0.20	0.5	2.0	5.0	2.5	ECEA1CN100U()	200	2000
	22	5	11	60	0.20	0.5	2.0	5.0	2.5	ECEA1CN220U()	200	2000
	33	5	11	80	0.20	0.5	2.0	5.0	2.5	ECEA1CN330U()	200	2000
	47	6.3	11.2	100	0.20	0.5	2.5	5.0	2.5	ECEA1CN470U()	200	2000
	220	10	12.5	260	0.20	0.6	5.0	5.0		ECEA1CN221X()	200	500
	330	10	16	330	0.20	0.6	5.0	5.0		ECEA1CN331U()	200	500
	470	10	20	380	0.20	0.6	5.0	5.0		ECEA1CN471U()	200	500
	1000	12.5	25	560	0.20	0.6	5.0	5.0		ECEA1CN102U()	200	500
	2200	16	31.5	750	0.22	0.8	7.5			ECEA1CN222U	100	
25	3300	18	35.5	900	0.24	0.8	7.5			ECEA1CN332U	50	
	10	5	11	45	0.15	0.5	2.0	5.0	2.5	ECEA1EN100U()	200	2000
	22	5	11	60	0.15	0.5	2.0	5.0	2.5	ECEA1EN220X()	200	2000
	33	6.3	11.2	90	0.15	0.5	2.5	5.0	2.5	ECEA1EN330U()	200	2000
	47	6.3	11.2	110	0.15	0.5	2.5	5.0	2.5	ECEA1EN470U()	200	2000
	100	8	11.5	180	0.15	0.6	3.5	5.0		ECEA1EN101U()	200	1000
	220	10	16	320	0.15	0.6	5.0	5.0		ECEA1EN221U()	200	500
	330	12.5	20	350	0.15	0.6	5.0	5.0		ECEA1EN331U()	200	500
	470	12.5	20	430	0.15	0.6	5.0	5.0		ECEA1EN471U()	200	500
	1000	16	25	680	0.15	0.8	7.5	7.5		ECEA1EN102U()	100	250
35	2200	18	35.5	900	0.17	0.8	7.5			ECEA1EN222U	50	
	10	5	11	43	0.15	0.5	2.0	5.0	2.5	ECEA1VN100U()	200	2000
	22	6.3	11.2	80	0.15	0.5	2.5	5.0	2.5	ECEA1VN220U()	200	2000
	33	8	11.5	100	0.15	0.6	3.5	5.0		ECEA1VN330U()	200	1000
	47	8	11.5	120	0.15	0.6	3.5	5.0		ECEA1VN470U()	200	1000
	100	10	16	230	0.15	0.6	5.0	5.0		ECEA1VN101U()	200	500
	220	12.5	20	360	0.15	0.6	5.0	5.0		ECEA1VN221U()	200	500
	330	12.5	20	450	0.15	0.6	5.0	5.0		ECEA1VN331U()	200	500
470	12.5	25	590	0.15	0.6	5.0	5.0		ECEA1VN471U()	200	500	

· When requesting taped product, please put the letter "B" or "i" between the "()". Lead wire pitch *B=5 mm, 7.5 mm, i=2.5 mm.
· Please refer to the page of "Taping Dimensions".

■ Standard Products (Bi-polar)

Endurance: 85 °C 2000 h (1000 hours for each polarity)

W.V. (V)	Cap. (±20 %) (μF)	Case size		Specification		Lead Length			Part No.	Min. Packaging Q'ty		
		Dia. (mm)	Length (mm)	Ripple Current (120 Hz) (+85 °C) (mA r.m.s.)	tan δ (120 Hz) (+20 °C) (Ω)	Lead Dia. (mm)	Lead Space			Straight Leads (pcs)	Taping (pcs)	
							Straight (mm)	Taping *B (mm)				Taping *i (mm)
50	0.47	5	11	10	0.15	0.5	2.0	5.0	2.5	ECEA1HNR47U()***	200	2000
	1	5	11	10	0.15	0.5	2.0	5.0	2.5	ECEA1HN010U()***	200	2000
	2.2	5	11	18	0.15	0.5	2.0	5.0	2.5	ECEA1HN2R2U()	200	2000
	3.3	5	11	25	0.15	0.5	2.0	5.0	2.5	ECEA1HN3R3U()	200	2000
	4.7	5	11	30	0.15	0.5	2.0	5.0	2.5	ECEA1HN4R7U()	200	2000
	10	6.3	11.2	50	0.15	0.5	2.5	5.0	2.5	ECEA1HN100U()	200	2000
	22	8	11.5	90	0.15	0.6	3.5	5.0		ECEA1HN220U()	200	1000
	33	8	11.5	110	0.15	0.6	3.5	5.0		ECEA1HN330U()	200	1000
	47	10	12.5	140	0.15	0.6	5.0	5.0		ECEA1HN470U()	200	500
	100	10	20	250	0.15	0.6	5.0	5.0		ECEA1HN101U()	200	500
	220	12.5	25	360	0.15	0.6	5.0	5.0		ECEA1HN221U()	200	500
	330	16	25	450	0.15	0.8	7.5	7.5		ECEA1HN331U()	100	250
	470	16	31.5	590	0.15	0.8	7.5			ECEA1HN471U	100	

· When requesting taped product, please put the letter "B" or "i" between the "()". Lead wire pitch *B=5 mm, 7.5 mm, i=2.5 mm.

· Please refer to the page of "Taping Dimensions".

*** Please kindly accept last shipment : 31/Mar/2015

Radial Lead Type

Series: **KA** Type: **A**

Low Profile

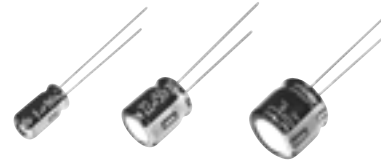

■ Features

- Endurance : 85° C 1000 h
- 7 mm height
- RoHS directive compliant

■ Specifications

Category Temp. Range	-40 °C to +85 °C		
Rated W.V. Range	4 V.DC to 50 V.DC		
Nominal Cap. Range	2.2 μF to 470 μF		
Capacitance Tolerance	±20 % (120 Hz/+20 °C)		
DC Leakage Current	$I \leq 0.01 CV$ or 3 (μA) After 2 minutes (Whichever is greater)		
tan δ	Please see the attached standard products list		
Endurance	After applying rated working voltage for 1000 hours at +85 °C±2 °C when the capacitors are restored to 20 °C, capacitors shall meet the following limits.		
	Capacitance change	± 20% of initial measured value	
	tan δ	≤ 200 % of initial specified value	
	DC leakage current	≤ initial specified value	
Shelf Life	After storage for 1000 hours at +85 °C±2 °C with no voltage applied and then being stabilized at +20 °C, capacitors shall meet the limits specified in Endurance (With voltage treatment)		

■ Frequency correction factor for ripple current

	Frequency (Hz)			
	50, 60	120	1 k	10 k to
Correction factor	0.70	1.00	1.30	1.70

■ Dimensions in mm (not to scale)

(Unit : mm)

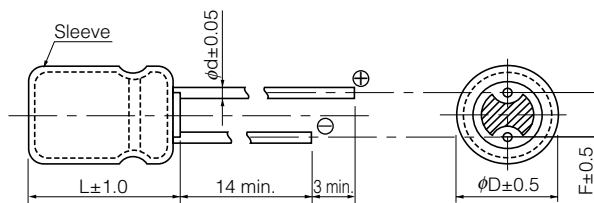

	4	5	6.3	8
Body Dia. φD	4	5	6.3	8
Lead Dia. φd	0.45	0.45	0.45	0.45
Lead space F	1.5	2.0	2.5	2.5

Standard Products

Endurance : 85 °C 1000 h

W.V. (V)	Cap. (±20 %) (μF)	Case size		Specification		Lead Length				Part No.	Min. Packaging Q'ty	
		Dia. (mm)	Length (mm)	Ripple Current (120 Hz) (+85 °C) (mA r.m.s.)	tan δ (120 Hz) (+20 °C)	Lead Dia. (mm)	Lead Space				Straight Leads (pcs)	Taping (pcs)
							Straight (mm)	Taping *B (mm)	Taping *i (mm)			
4	47	4	7	34	0.35	0.45	1.5	5.0	2.5	ECEA0GKA470()	200	2000
	100	5	7	61	0.35	0.45	2.0	5.0	2.5	ECEA0GKA101()	200	2000
	220	6.3	7	82	0.35	0.45	2.5	5.0	2.5	ECEA0GKA221()	200	2000
	330	8	7	110	0.35	0.45	2.5		2.5	ECEA0GKA331()	200	1000
		8	7	110	0.35	0.45		5.0		ECEA0GKA331Q		1000
	470	8	7	140	0.35	0.45	2.5		2.5	ECEA0GKA471()	200	1000
8		7	140	0.35	0.45		5.0		ECEA0GKA471Q		1000	
6.3	47	4	7	46	0.24	0.45	1.5	5.0	2.5	ECEA0JKA470()	200	2000
	100	5	7	71	0.24	0.45	2.0	5.0	2.5	ECEA0JKA101()	200	2000
	220	6.3	7	103	0.24	0.45	2.5	5.0	2.5	ECEA0JKA221()	200	2000
	330	8	7	130	0.24	0.45	2.5		2.5	ECEA0JKA331()	200	1000
		8	7	130	0.24	0.45		5.0		ECEA0JKA331Q		1000
10	33	4	7	43	0.20	0.45	1.5	5.0	2.5	ECEA1AKA330()	200	2000
	100	6.3	7	80	0.20	0.45	2.5	5.0	2.5	ECEA1AKA101()	200	2000
	220	8	7	120	0.20	0.45	2.5		2.5	ECEA1AKA221()	200	1000
		8	7	120	0.20	0.45		5.0		ECEA1AKA221Q		1000
16	10	4	7	28	0.16	0.45	1.5	5.0	2.5	ECEA1CKA100()	200	2000
	22	4	7	39	0.16	0.45	1.5	5.0	2.5	ECEA1CKA220()	200	2000
	33	5	7	60	0.16	0.45	2.0	5.0	2.5	ECEA1CKA330()	200	2000
	47	5	7	70	0.16	0.45	2.0	5.0	2.5	ECEA1CKA470()	200	2000
	100	6.3	7	91	0.16	0.45	2.5	5.0	2.5	ECEA1CKA101()	200	2000
25	10	4	7	28	0.14	0.45	1.5	5.0	2.5	ECEA1EKA100()	200	2000
	22	5	7	55	0.14	0.45	2.0	5.0	2.5	ECEA1EKA220()	200	2000
	33	6.3	7	65	0.14	0.45	2.5	5.0	2.5	ECEA1EKA330()	200	2000
	47	6.3	7	70	0.14	0.45	2.5	5.0	2.5	ECEA1EKA470()	200	2000
35	10	5	7	30	0.12	0.45	2.0	5.0	2.5	ECEA1VKA100()	200	2000
	22	6.3	7	60	0.12	0.45	2.5	5.0	2.5	ECEA1VKA220()	200	2000
	33	6.3	7	65	0.12	0.45	2.5	5.0	2.5	ECEA1VKA330()	200	2000
	47	8	7	85	0.12	0.45	2.5		2.5	ECEA1VKA470()	200	1000
		8	7	85	0.12	0.45		5.0		ECEA1VKA470Q		1000
50	0.1	4	7	1	0.10	0.45	1.5	5.0	2.5	ECEA1HKA0R1()***	200	2000
	0.22	4	7	2	0.10	0.45	1.5	5.0	2.5	ECEA1HKAR22()***	200	2000
	0.33	4	7	3	0.10	0.45	1.5	5.0	2.5	ECEA1HKAR33()***	200	2000
	0.47	4	7	5	0.10	0.45	1.5	5.0	2.5	ECEA1HKAR47()***	200	2000
	1	4	7	10	0.10	0.45	1.5	5.0	2.5	ECEA1HKA010()***	200	2000
	2.2	4	7	16	0.10	0.45	1.5	5.0	2.5	ECEA1HKA2R2()	200	2000
	3.3	4	7	18	0.10	0.45	1.5	5.0	2.5	ECEA1HKA3R3()	200	2000
	4.7	4	7	23	0.10	0.45	1.5	5.0	2.5	ECEA1HKA4R7()	200	2000
	10	5	7	35	0.10	0.45	2.0	5.0	2.5	ECEA1HKA100()	200	2000
	22	6.3	7	60	0.10	0.45	2.5	5.0	2.5	ECEA1HKA220()	200	2000
	33	8	7	75	0.10	0.45	2.5		2.5	ECEA1HKA330()	200	1000
8		7	75	0.10	0.45		5.0		ECEA1HKA330Q		1000	

· When requesting taped product, please put the letter "B" or "i" between the "()". Lead wire pitch *B=5 mm, i=2.5 mm.

· Please refer to the page of "Taping Dimensions".

*** Please kindly accept last shipment : 31/Mar/2015

Design and specifications are each subject to change without notice. Ask factory for the current technical specifications before purchase and/or use.
Should a safety concern arise regarding this product, please be sure to contact us immediately.

Radial Lead Type

Series: **KA(Bi-polar)** Type: **A**

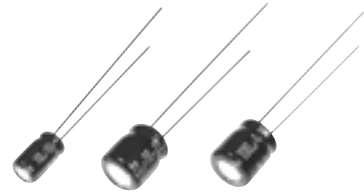

■ Features

- Endurance : 85° C 1000 h
- 7 mm height
- RoHS directive compliant

■ Specifications

Category Temp. Range	-40 °C to +85 °C		
Rated W.V. Range	4 V.DC to 50 V.DC		
Nominal Cap. Range	2.2 μF to 100 μF		
Capacitance Tolerance	±20 % (120 Hz/+20 °C)		
DC Leakage Current	I ≤ 0.05 CV or 10 (μA) After 2 minutes (Whichever is greater)		
tan δ	Please see the attached standard products list		
Endurance	After 1000 hours application of DC working voltage (500 hours for each polarity) at +85 °C±2 °C, when the capacitors are restored to 20 °C, the capacitors shall meet the following limits.		
	Capacitance change	± 20% of initial measured value	
	tan δ	≤200 % of initial specified value	
	DC leakage current	≤initial specified value	
Shelf Life	After storage for 1000 hours at +85 °C±2 °C with no voltage applied and then being stabilized at +20 °C, capacitors shall meet the limits specified in Endurance (With voltage treatment)		

■ Frequency correction factor for ripple current

	Frequency (Hz)			
	50, 60	120	1 k	10 k to
Correction factor	0.70	1.00	1.30	1.70

■ Dimensions in mm (not to scale)

(Unit : mm)



Body Dia. φD	4	5	6.3
Lead Dia. φd	0.45	0.45	0.45
Lead space F	1.5	2.0	2.5

■ Standard Products (Bi-polar)

Endurance : 85 °C 1000 h (500hours for each polarity)

W.V. (V)	Cap. (±20 %) (μF)	Case size		Specification		Lead Length			Part No.	Min. Packaging Q'ty		
		Dia. (mm)	Length (mm)	Ripple Current (120 Hz) (+85 °C) (mA r.m.s.)	tan δ (120 Hz) (+20 °C)	Lead Dia. (mm)	Lead Space			Straight Leads (pcs)	Taping (pcs)	
							Straight (mm)	Taping *B (mm)				Taping *i (mm)
4	100	6.3	7	61	0.35	0.45	2.5	5.0	2.5	ECEA0GKN101()	200	2000
	22	5	7	29	0.24	0.45	2.0	5.0	2.5	ECEA0JKN220()	200	2000
6.3	33	5	7	38	0.24	0.45	2.0	5.0	2.5	ECEA0JKN330()	200	2000
	47	6.3	7	46	0.24	0.45	2.5	5.0	2.5	ECEA0JKN470()	200	2000
10	10	4	7	25	0.20	0.45	1.5	5.0	2.5	ECEA1AKN100()	200	2000
	22	5	7	35	0.20	0.45	2.0	5.0	2.5	ECEA1AKN220()	200	2000
	33	6.3	7	43	0.20	0.45	2.5	5.0	2.5	ECEA1AKN330()	200	2000
	47	6.3	7	65	0.20	0.45	2.5	5.0	2.5	ECEA1AKN470()	200	2000
16	4.7	4	7	20	0.16	0.45	1.5	5.0	2.5	ECEA1CKN4R7()	200	2000
	10	5	7	25	0.16	0.45	2.0	5.0	2.5	ECEA1CKN100()	200	2000
	22	6.3	7	39	0.16	0.45	2.5	5.0	2.5	ECEA1CKN220()	200	2000
	33	6.3	7	60	0.16	0.45	2.5	5.0	2.5	ECEA1CKN330()	200	2000
25	3.3	4	7	16	0.16	0.45	1.5	5.0	2.5	ECEA1EKN3R3()	200	2000
	4.7	5	7	21	0.16	0.45	2.0	5.0	2.5	ECEA1EKN4R7()	200	2000
	10	6.3	7	28	0.16	0.45	2.5	5.0	2.5	ECEA1EKN100()	200	2000
	22	6.3	7	55	0.16	0.45	2.5	5.0	2.5	ECEA1EKN220()	200	2000
35	2.2	4	7	12	0.14	0.45	1.5	5.0	2.5	ECEA1VKN2R2()	200	2000
	3.3	5	7	16	0.14	0.45	2.0	5.0	2.5	ECEA1VKN3R3()	200	2000
	4.7	5	7	22	0.14	0.45	2.0	5.0	2.5	ECEA1VKN4R7()	200	2000
	10	6.3	7	30	0.14	0.45	2.5	5.0	2.5	ECEA1VKN100()	200	2000
50	0.1	4	7	1	0.12	0.45	1.5	5.0	2.5	ECEA1HKN0R1()***	200	2000
	0.22	4	7	2	0.12	0.45	1.5	5.0	2.5	ECEA1HKNR22()***	200	2000
	0.33	4	7	3	0.12	0.45	1.5	5.0	2.5	ECEA1HKNR33()***	200	2000
	0.47	4	7	5	0.12	0.45	1.5	5.0	2.5	ECEA1HKNR47()***	200	2000
	1	4	7	10	0.12	0.45	1.5	5.0	2.5	ECEA1HKN010()***	200	2000
	2.2	5	7	16	0.12	0.45	2.0	5.0	2.5	ECEA1HKN2R2()	200	2000
	3.3	5	7	16	0.12	0.45	2.0	5.0	2.5	ECEA1HKN3R3()	200	2000
	4.7	6.3	7	23	0.12	0.45	2.5	5.0	2.5	ECEA1HKN4R7()	200	2000

· When requesting taped product, please put the letter "B" or "i" between the "()". Lead wire pitch *B=5 mm, 7.5 mm, i=2.5 mm.

· Please refer to the page of "Taping Dimensions".

*** Please kindly accept last shipment : 31/Mar/2015

Radial Lead Type

Series: **KS** Type: **A**

■ Features

- Endurance : 85° C 1000 h
- 5 mm height
- RoHS directive compliant

Low Profile

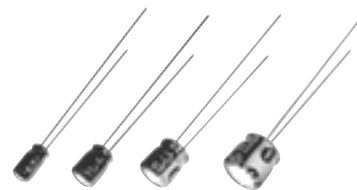
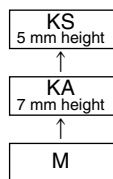

■ Specifications

Category Temp. Range	-40 °C to +85 °C	
Rated W.V. Range	4 V.DC to 50 V.DC	
Nominal Cap. Range	2.2 μF to 330 μF	
Capacitance Tolerance	±20 % (120 Hz/+20 °C)	
DC Leakage Current	$I \leq 0.01 CV$ or 3 (μA) After 2 minutes (Whichever is greater)	
tan δ	Please see the attached standard products list	
Endurance	After applying rated working voltage for 1000 hours at +85 °C±2 °C, when the capacitors are restored to 20°C capacitors, shall meet the following limits.	
	Capacitance change	± 20% of initial measured value (4 V : ±30 %)
	tan δ	≤ 200 % of initial specified value
	DC leakage current	≤ initial specified value
Shelf Life	After storage for 1000 hours at +85 °C±2 °C with no voltage applied and then being stabilized at +20 °C, capacitors shall meet the limits specified in Endurance (With voltage treatment)	

■ Frequency correction factor for ripple current

	Frequency (Hz)			
	50, 60	120	1 k	10 k to
Correction factor	0.70	1.00	1.30	1.70

■ Dimensions in mm (not to scale)

(Unit : mm)

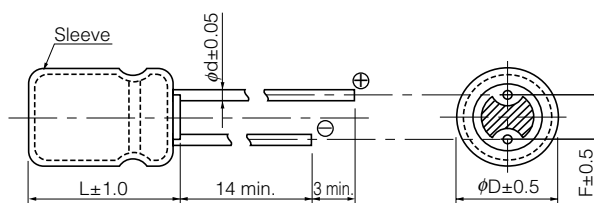

Body Dia. φD	4	5	6.3	8
Lead Dia. φd	0.45	0.45	0.45	0.45
Lead space F	1.5	2.0	2.5	2.5

Standard Products

Endurance : 85 °C 1000 h

W.V.	Cap. (±20 %)	Case size		Specification		Lead Length				Part No.	Min. Packaging Q'ty		
		Dia.	Length	Ripple Current (120 Hz) (+85 °C) (mA r.m.s.)	tan δ (120 Hz) (+20 °C)	Lead Dia.	Lead Space				Straight Leads	Taping	
							Straight	Taping *B	Taping *i				(pcs)
(V)	(μF)	(mm)	(mm)	(mA r.m.s.)		(mm)	(mm)	(mm)			(pcs)	(pcs)	
4	33	4	5	26	0.35	0.45	1.5	5.0	2.5	ECEA0GKS330()	200	2000	
	47	4	5	34	0.35	0.45	1.5	5.0	2.5	ECEA0GKS470()	200	2000	
	100	5	5	61	0.35	0.45	2.0	5.0	2.5	ECEA0GKS101()	200	2000	
	220	6.3	5	82	0.35	0.45	2.5	5.0	2.5	ECEA0GKS221()	200	2000	
6.3	22	4	5	29	0.24	0.45	1.5	5.0	2.5	ECEA0JKS220()	200	2000	
	33	5	5	38	0.24	0.45	2.0	5.0	2.5	ECEA0JKS330()	200	2000	
	47	5	5	46	0.24	0.45	2.0	5.0	2.5	ECEA0JKS470()	200	2000	
	100	6.3	5	71	0.24	0.45	2.5	5.0	2.5	ECEA0JKS101()	200	2000	
	330	8	5	130	0.24	0.45	2.5		2.5	ECEA0JKS331()	200	1000	
		8	5	130	0.24	0.45		5.0		ECEA0JKS331Q		1000	
10	22	5	5	35	0.20	0.45	2.0	5.0	2.5	ECEA1AKS220()	200	2000	
	33	5	5	43	0.20	0.45	2.0	5.0	2.5	ECEA1AKS330()	200	2000	
	47	6.3	5	65	0.20	0.45	2.5	5.0	2.5	ECEA1AKS470()	200	2000	
	100	6.3	5	80	0.20	0.45	2.5	5.0	2.5	ECEA1AKS101()	200	2000	
	220	8	5	120	0.20	0.45	2.5		2.5	ECEA1AKS221()	200	1000	
		8	5	120	0.20	0.45		5.0		ECEA1AKS221Q		1000	
16	10	4	5	28	0.16	0.45	1.5	5.0	2.5	ECEA1CKS100()	200	2000	
	22	5	5	39	0.16	0.45	2.0	5.0	2.5	ECEA1CKS220()	200	2000	
	33	6.3	5	60	0.16	0.45	2.5	5.0	2.5	ECEA1CKS330()	200	2000	
	47	6.3	5	70	0.16	0.45	2.5	5.0	2.5	ECEA1CKS470()	200	2000	
	100	8	5	91	0.16	0.45	2.5		2.5	ECEA1CKS101()	200	1000	
		8	5	91	0.16	0.45		5.0		ECEA1CKS101Q		1000	
25	4.7	4	5	22	0.14	0.45	1.5	5.0	2.5	ECEA1EKS4R7()	200	2000	
	10	5	5	28	0.14	0.45	2.0	5.0	2.5	ECEA1EKS100()	200	2000	
	22	6.3	5	55	0.14	0.45	2.5	5.0	2.5	ECEA1EKS220()	200	2000	
	33	6.3	5	65	0.14	0.45	2.5	5.0	2.5	ECEA1EKS330()	200	2000	
	100	8	5	85	0.14	0.45	2.5		2.5	ECEA1EKS101()	200	1000	
		8	5	85	0.14	0.45		5.0		ECEA1EKS101Q		1000	
35	3.3	4	5	16	0.12	0.45	1.5	5.0	2.5	ECEA1VKS3R3()	200	2000	
	4.7	4	5	22	0.12	0.45	1.5	5.0	2.5	ECEA1VKS4R7()	200	2000	
	10	5	5	30	0.12	0.45	2.0	5.0	2.5	ECEA1VKS100()	200	2000	
	22	6.3	5	60	0.12	0.45	2.5	5.0	2.5	ECEA1VKS220()	200	2000	
	33	8	5	65	0.12	0.45	2.5		2.5	ECEA1VKS330()	200	1000	
			8	5	65	0.12	0.45		5.0		ECEA1VKS330Q		1000
	47	8	5	85	0.12	0.45	2.5		2.5	ECEA1VKS470()	200	1000	
		8	5	85	0.12	0.45		5.0		ECEA1VKS470Q		1000	
50	0.1	4	5	1	0.10	0.45	1.5	5.0	2.5	ECEA1HKS0R1()***	200	2000	
	0.22	4	5	2	0.10	0.45	1.5	5.0	2.5	ECEA1HKS0R2()***	200	2000	
	0.33	4	5	3	0.10	0.45	1.5	5.0	2.5	ECEA1HKS0R3()***	200	2000	
	0.47	4	5	5	0.10	0.45	1.5	5.0	2.5	ECEA1HKS0R4()***	200	2000	
	1	4	5	10	0.10	0.45	1.5	5.0	2.5	ECEA1HKS010()***	200	2000	
	2.2	4	5	16	0.10	0.45	1.5	5.0	2.5	ECEA1HKS2R2()	200	2000	
	3.3	4	5	16	0.10	0.45	1.5	5.0	2.5	ECEA1HKS3R3()	200	2000	
	4.7	5	5	23	0.10	0.45	2.0	5.0	2.5	ECEA1HKS4R7()	200	2000	
	10	6.3	5	35	0.10	0.45	2.5	5.0	2.5	ECEA1HKS100()	200	2000	
	22	8	5	60	0.10	0.45	2.5		2.5	ECEA1HKS220()	200	1000	
		8	5	60	0.10	0.45		5.0		ECEA1HKS220Q		1000	

· When requesting taped product, please put the letter "B" or "i" between the "()". Lead wire pitch *B=5 mm, i=2.5 mm.

· Please refer to the page of "Taping Dimensions".

*** Please kindly accept last shipment : 31/Mar/2015

Design and specifications are each subject to change without notice. Ask factory for the current technical specifications before purchase and/or use.
Should a safety concern arise regarding this product, please be sure to contact us immediately.

02 May, 2014

Radial Lead Type

Series: **KS(Bi-polar)** Type: **A**



■ Features

- Endurance : 85° C 1000 h
- 5 mm height
- RoHS directive compliant

■ Specifications

Category Temp. Range	-40 °C to +85 °C	
Rated W.V. Range	63 V.DC to 50 V.DC	
Nominal Cap. Range	2.2 μF to 47 μF	
Capacitance Tolerance	±20 % (120 Hz/+20 °C)	
DC Leakage Current	I ≤ 0.05 CV or 10 (μA) After 2 minutes (Whichever is greater)	
tan δ	Please see the attached standard products list	
Endurance	After 1000 hours application of DC working voltage (500 hours for each polarity) at +85 °C±2 °C, when the capacitors are restored to 20 °C, the capacitors shall meet the following limits.	
	Capacitance change	± 20% of initial measured value
	tan δ	≤200 % of initial specified value
	DC leakage current	≤initial specified value
Shelf Life	After storage for 1000 hours at +85 °C±2 °C with no voltage applied and then being stabilized at +20 °C, capacitors shall meet the limits specified in Endurance (With voltage treatment)	

■ Frequency correction factor for ripple current

	Frequency (Hz)			
	50, 60	120	1 k	10 k to
Correction factor	0.70	1.00	1.30	1.70

■ Dimensions in mm (not to scale)

(Unit : mm)

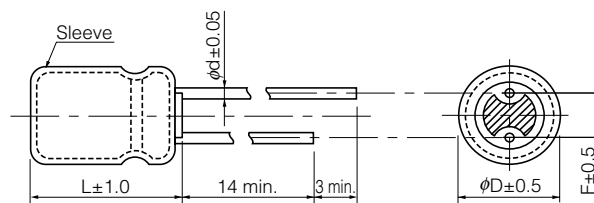

Body Dia. φD	4	5	6.3
Lead Dia. φd	0.45	0.45	0.45
Lead space F	1.5	2.0	2.5

■ Standard Products (Bi-polar)

Endurance : 85 °C 1000 h (500hours for each polarity)

W.V. (V)	Cap. (±20 %) (μF)	Case size		Specification		Lead Length			Part No.	Min. Packaging Q'ty		
		Dia. (mm)	Length (mm)	Ripple Current (120 Hz) (+85 °C) (mA r.m.s.)	tan δ (120 Hz) (+20 °C)	Lead Dia. (mm)	Lead Space			Straight Leads (pcs)	Taping (pcs)	
							Straight (mm)	Taping *B (mm)				Taping *i (mm)
6.3	22	5	5	29	0.24	0.45	2.0	5.0	2.5	ECEA0JSN220()	200	2000
	33	6.3	5	38	0.24	0.45	2.5	5.0	2.5	ECEA0JSN330()	200	2000
	47	6.3	5	46	0.24	0.45	2.5	5.0	2.5	ECEA0JSN470()	200	2000
10	10	4	5	25	0.20	0.45	1.5	5.0	2.5	ECEA1ASN100()	200	2000
	22	6.3	5	35	0.20	0.45	2.5	5.0	2.5	ECEA1ASN220()	200	2000
	33	6.3	5	43	0.20	0.45	2.5	5.0	2.5	ECEA1ASN330()	200	2000
16	4.7	4	5	20	0.20	0.45	1.5	5.0	2.5	ECEA1CSN4R7()	200	2000
	10	5	5	25	0.20	0.45	2.0	5.0	2.5	ECEA1CSN100()	200	2000
	22	6.3	5	39	0.20	0.45	2.5	5.0	2.5	ECEA1CSN220()	200	2000
25	3.3	5	5	18	0.20	0.45	2.0	5.0	2.5	ECEA1ESN3R3()	200	2000
	4.7	5	5	21	0.20	0.45	2.0	5.0	2.5	ECEA1ESN4R7()	200	2000
	10	6.3	5	28	0.20	0.45	2.5	5.0	2.5	ECEA1ESN100()	200	2000
35	2.2	4	5	12	0.20	0.45	1.5	5.0	2.5	ECEA1VSN2R2()	200	2000
50	0.1	4	5	1	0.20	0.45	1.5	5.0	2.5	ECEA1HSN0R1()***	200	2000
	0.22	4	5	2	0.20	0.45	1.5	5.0	2.5	ECEA1HSNR22()***	200	2000
	0.33	4	5	3	0.20	0.45	1.5	5.0	2.5	ECEA1HSNR33()***	200	2000
	0.47	4	5	5	0.20	0.45	1.5	5.0	2.5	ECEA1HSNR47()***	200	2000
	1	4	5	10	0.20	0.45	1.5	5.0	2.5	ECEA1HSN010()***	200	2000
	2.2	5	5	16	0.20	0.45	2.0	5.0	2.5	ECEA1HSN2R2()	200	2000

· When requesting taped product, please put the letter "B" or "i" between the "()". Lead wire pitch *B=5 mm, i=2.5 mm.

· Please refer to the page of "Taping Dimensions".

*** Please kindly accept last shipment : 31/Mar/2015

Notices

■ Applicable laws and regulations

- This product satisfies the requirements of the RoHS Directive (2011/65/EU) (related to the specified hazardous substances contained in electrical and electronic equipment).
- The ozone-depleting chemicals regulated by the Montreal Protocol are not intentionally used in the materials used in our manufacturing processes.
- PBBs(Poly-Brominated Biphenyls)/PBDEs (Poly-Brominated Diphenyl ethers)
The above specified brominated flame retardants are not intentionally used.
- When exporting this product, observe the export procedures specified in export control laws such as the Foreign Exchange and Foreign Trade Control Law.

■ Limited applications

- This product is intended to be used for general-purpose standard applications for general electronic equipment (such as AV equipment, household appliances, business or office equipment, information or communications equipment, etc.)
- If this product is being examined for possible use in applications where higher reliability or safety is required, in cases where a malfunction of this product may endanger life or property, then the delivery specifications meeting the application requirements must be agreed to and exchanged.

Items to be observed

- (1) The purpose of these specifications is to ensure the quality of components as individual components.
Before use, check and evaluate their operation when mounted on your products.
- (2) Do not use our components outside of the corresponding specifications.

■ When using this capacitor in a product where safety is critical

We take great care in the quality of this product. However, performance may deteriorate and short-circuiting or open-circuiting may occur if it will be used in transportation equipment (e.g. trains, cars, traffic lights), medical equipment, airborne equipment, aerospace equipment, electric heating appliances, combustion/gas equipment, rotating equipment, disaster/crime prevention equipment, or other equipment where a defect in this component may cause the loss of human life or other significant damage. Ensure that the target equipment has a failsafe design and is provided with the following systems to guarantee adequate safety.

- (1) * Ensure the safety of the whole system by installing a protection circuit and a protection device.
- (2) Redundant circuits, etc. to maintain the safety of the entire system so that a single independent failure will not lead to unsafe conditions.

■ Conditions of use

This product is intended to be used in electronic equipment for general-purpose standard applications and is not designed for use in any special environments.
When this capacitor is used in a special environment or under special conditions, its performance may be affected. Before use, verify the performance and reliability of the capacitor.

⚠ Application Guidelines

1. Circuit design

Verify the usage and fitting environments and make sure to observe the rated performance specified in the corresponding catalog or specifications.

1.1 Operating temperature and frequency

Variations in temperature and frequency can affect the electrical characteristics of capacitors. Design circuits allowing for these variations.

- (1) At high temperatures leakage current increases.
- (2) At low temperatures the capacitance decreases and an increase in the tangent of the loss angle and impedance.
- (3) As frequency increases, capacitance decreases and the tangent of the loss angle increases, while the capacitive portion of impedance decreases till the resonant frequency is reached.
- (4) At low frequency there is temperature rise caused by ripple currents accompanying the increase in equivalent series resistance.

1.2 Operating temperature and life expectancy

- (1) The capacitor life is affected by usage temperature.
In general, the capacitor life is approximately doubled when the temperature decreases by 10 °C.
Reduce the usage temperature as much as possible.
- (2) The use of capacitors beyond the upper category temperatures may cause rapid deterioration in the characteristics and break down may occur.
The temperature referred to here includes the ambient temperature(within equipment), including heat produced by heat generating devices (power transistors, resistors, etc.), self-heating due to ripple currents, etc. Take these factors into consideration when checking the temperature of capacitors.
Do not place any heat generating devices, etc. on the back of capacitors.
- (3) The life acceleration can be calculated with the following equation:

$$L_2 = L_1 \times 2^{\frac{T_1 - T_2}{10}}$$

L₁: Life at a temperature T₁ °C (h)

L₂: Life at a temperature T₂ °C (h)

T₁: Category upper limit temperature + heat generation due to ripple currents (°C)

T₂: Ambient temperature to calculate the life + heat generation due to ripple currents (°C)

1.3 Common application conditions to avoid

If the loads shown below are applied to a capacitor, then its characteristics may degrade rapidly or it may short-circuit. Rapid heat or gas generation may occur, which leads to the activation of the pressure valve. Electrolytes will then leak from the sealing section. In the worst case, an explosion or ignition may occur.

When the capacitor breaks down, combustible materials (electrolytes, element fixing materials, etc.) may flow externally in all directions.

(1) Polarity

Aluminum electrolytic capacitors have polarities.

Do not apply a reversed or alternating-current voltage.

If the polarity is reversed, then short-circuiting may occur in the initial state or the pressure valve may be activated, leading to capacitor breakdown.

Check the polarity when using a polar capacitor.

If the polarity is unstable or unclear in a circuit, then use bipolar capacitors. However, bipolar capacitors cannot be used in alternating current circuits.

(2) Applied voltage

Do not apply an excessive voltage (voltage exceeding the rating).

The peak direct current voltage superposed with a ripple voltage (alternating current component) must be equal to or less than the rated voltage. A surge voltage exceeding the rated voltage is allowed and specified. However, the allowable conditions are limited and the specifications do not guarantee the application of such a surge voltage for a long time.

(3) Ripple current

Do not allow an excessive current (current exceeding the rated ripple current) to pass.

If an excessive ripple current passes through, then the amount of internally generated heat will grow, the capacitor life will be reduced, or the pressure valve will be activated, leading to breakdown.

Even if the current is equivalent to or less than the allowable level, a reversed voltage may be applied when a direct current bias voltage is low.

Use capacitors so that a reversed voltage is not applied.

- (4) Charging/discharging applications
Standard capacitors are not suitable for use in repeating charge/discharge applications. For charge/discharge applications, consult us with your actual application condition.
For rush current, please do not exceed 100 A.
- (5) ON-OFF circuit
Do not use capacitors in circuit where ON-OFF switching is repeated more than 10000 times/per day.
In case of applying to the these ON-OFF circuit, consult with us about circuit condition and so on.
- (6) Series/parallel connection
[Parallel connection]
If capacitors are connected in parallel, then the balance of currents between these capacitors may be disrupted and an excessive ripple current may pass through only part of these capacitors.
Wire your circuits such that excessive ripple current does not pass through the capacitors.
[Series connection]
If capacitors are connected in series, then the balance of voltages between these capacitors may be disrupted and excessive voltage may be applied. Add a bleeder resistor in parallel with each capacitor. By taking leak currents into consideration the balance of voltages will not be disrupted.
- (7) Electrical isolation of the capacitors
Isolate capacitors completely in a circuit in the following cases.
Between the housing and cathode and anode terminals and between circuit traces.
- (8) Capacitor sleeve
Exterior sleeves or lamination covering capacitors are for indication purposes only and do not guarantee electrical insulation.

1.4 Capacitor mounting considerations

For aluminum electrolytic capacitors, conductive electrolysis whose main solvent is combustible organic solvent and combustible electrolytic paper is used.
If the electrolysis leaks onto a printed circuit board, then it may corrode or short-circuit the traces, leading to smoke or fire. Check the following points when designing products.

- (1) Double-sided circuit board
If capacitors are used in double-sided boards, then do not lay wiring traces immediately below the capacitors.
If the sealed part of a capacitor adheres to the surface of a through-hole printed circuit board, then the solder may be absorbed into the gap during dip soldering and the anode and cathode terminals may be short-circuited.
- (2) Circuit board hole positioning
Solder may protrude from the through-holes or holes for post-mounted component leads and damage the capacitor exterior sleeves. Be mindful of the hole positions.
- (3) Circuit board hole spacing
Make holes for capacitors with a gap equivalent to that of capacitor leads (terminals) during design. Otherwise, there will be stress on the capacitor leads when they are inserted into these holes, leading to current leaks, short-circuiting, or electrolysis leakage.
- (4) Surface-mount types
For surface-mount type capacitors, design land traces with reference to the recommended board land sizes described in the delivery specifications, etc.
- (5) Capacitors equipped with pressure valves
Provide a space above the pressure valve so that it can operate properly.
For capacitors equipped with a pressure valve (as per the shape and dimensional descriptions of each series), provide a space as follows. If the space is smaller than the requirements, then the pressure valve may not operate properly, leading to an explosion.

Product diameter	Space
φ6.3 to φ16 mm	2 mm or more
φ18 to φ35 mm	3 mm or more
φ40 mm or more	5 mm or more

- (6) Clearance for seal mounted pressure relief vents
When the pressure valve section of a capacitor faces the printed wiring, provide a degassing hole aligned with the pressure valve position for proper operation of the valve.
- (7) Wiring near the pressure relief vent.
Considerations must be taken in designing circuits so that there are no traces, particularly for high-voltage or large-current wiring, above the pressure valve sections.
When a pressure valve is activated, combustible high-temperature gas exceeding 100°C will be released. Gas may condense or the wiring covers may melt and secondary accidents may occur.
- (8) Circuit board patterns under the capacitor.
If electrolysis leaks, then the circuit traces may short-circuit and tracking or migration may occur.

Design and specifications are each subject to change without notice. Ask factory for the current technical specifications before purchase and/or use.
Should a safety concern arise regarding this product, please be sure to contact us immediately.

2. Mounting

2.1 Considerations before using

- (1) Do not reuse capacitors that have been installed and energized.
- (2) Capacitors may generate transient recovery voltages. In this case, discharge them using a resistor of approx. 1 k Ω .
- (3) Capacitors stored for a long time may have a larger current leak.
In this case, dispose the voltage using a resistor of approx. 1 k Ω .
- (4) Do not drop capacitors onto a floor, etc.
Do not use dropped capacitors because they may be damaged mechanically or electrically.
- (5) Do not use corrupted capacitors.
If a capacitor's seal is deteriorated, then its performance will be degraded, life reduced, and/or the electrolyte will leak.

2.2 Capacitor insertion

- (1) Check the capacitor ratings (capacitance and voltage) before mounting.
- (2) Check the capacitor polarity before mounting.
- (3) Check the capacitor lead and hole intervals and land size before mounting.
If these intervals are different, then stress will be applied to the inside of the capacitor through its leads when they are inserted into the board holes, leading to short-circuiting or other failures.
- (4) When an automatic mounter is used, the force to clinch and fix capacitor leads must not be excessive.
When capacitor leads are clinched and fixed onto a circuit board, the leads may be pulled and a large force applied to the capacitor if there are missing cogs or the gap between the clinching section and the circuit board is too small. If this is the case, then the capacitor may break down.
For surface-mount type capacitors, if the mounting pressure is excessive, then current leaks may increase, short-circuiting may occur, or the capacitor may break down and come off.

2.3 Manual soldering

- (1) Solder capacitors under the soldering conditions (temperature and time) as described in the specifications or at 350 °C for three seconds or less.
- (2) If the capacitor lead terminals must be pre-processed in order to align the gaps between the terminals and holes, place them before soldering to prevent stress from being applied to the capacitor body.
- (3) If it is necessary to manually remove soldered capacitors, repair them after the solder has sufficiently melted to prevent stress from being applied to the capacitor terminals.
- (4) Do not touch the capacitor body with the soldering iron tip. Otherwise, a hole may occur on the capacitor exterior sleeve. The sleeve may break or become damaged.

2.4 Flow soldering

- (1) Do not immerse the capacitor body in a solder bath. The capacitor's inner pressure could increase and the capacitor will break down.
- (2) Solder capacitors under the soldering conditions (temperature and time) described in the specifications.
- (3) When soldering, do not allow other components to fall or touch the capacitors.
When soldering, if resistors, ceramic capacitors, or other components (with a high heat conductance) fall and their lead terminals or metallic sections touch the capacitor, then local thermal stress can occur causing the capacitor's exterior sleeve to break down. This phenomenon is identical to short-circuiting.
- (4) Prevent flux from adhering to anything other than the terminals.

2.5 Reflow soldering for chip capacitors

- (1) Surface-mount type capacitor are exclusively for reflow soldering. When reflow solder is used an ambient heat condition system such as the simultaneous use of infrared and hot-air is recommended.
* This system cannot be used for flow or dip soldering.
- (2) Soldering capacitors under the soldering conditions (pre-heating, soldering temperature and time) described in the specifications.
- (3) Reflow-solder only once.
If you need to apply reflow soldering twice, then make sure to contact us.
- (4) Do not reuse the installed surface-mount type capacitors.
- (5) The crack on top marking might be occurred by reflow heat stress.
But please acknowledge that it does not influence the reliability of the product.
- (6) VPS (Vapor Phase Soldering) reflow can cause significant characteristics change and/ or mounting failure due to deformation by acute temperature rise. VPS is acceptable provided that the process does not exceed recommended reflow profile and temperature rise is less than 3degC/sec. Please contact Panasonic for detailed conditions.

2.6 Other soldering considerations

If the chip capacitor temperature becomes very high due to pre-heating or hardening of the fixing resin, then the capacitor exterior sleeve may shrink or crack. If capacitors are passed through a heat-curing furnace, then the ambient temperature must be 150°C or less and the duration must be two minutes or less.

2.7 Capacitor handling after soldering

- (1) Do not tilt, bring down, or twist the capacitors soldered to the printed circuit board; otherwise a torque will be generated with the capacitor circumference as the fulcrum. As a result, a large force will be applied to the inside of the element through the terminals and the capacitor may break down.
- (2) Do not hold the capacitors soldered to the printed circuit board to carry the board; otherwise the board's entire weight will be applied to the inside of the element through the terminals and the capacitor may break down.
- (3) Do not hit the capacitors soldered to the printed circuit board with foreign objects. When stacking printed circuit boards, do not hit the capacitors with circuit boards or other components (terminals, etc.)

2.8 Circuit board cleaning

- (1) Apply the following conditions to flux cleaning after soldering

Temperature: 60°C or less, duration: Five minutes or less (Ultrasonic waves may be used.)
However, rinse sufficiently and dry the boards (at 100°C for 20 minutes or less).

[Applicable solvents]

Pine Alpha ST-100S
Clean-thru 750H, 750L, or 710M
Aqua Cleaner 210SEP
Sunelec B-12
DK Beclear CW-5790
Techno Cleaner 219
Cold Cleaner P3-375
Telpen Cleaner EC-7R
Techno Care FRW-17, FRW-1, or FRV-1
Isopropyl alcohol (IPA)

Remarks

- 1 : If you wish to use solvents other than the above or Deionized water, please contact us.
- 2 : Please do not use ozone-depleting chemicals in order to protect the environment.
- 3 : Depending on the cleaning method, the marking on a capacitor may be erased or blurred.

- (2) Avoid using the following solvent groups unless specifically allowed for in the specification

- (a) Halogen solvents: Corrode the inside capacitors.

The solvent may enter (diffuse) inside the capacitor, decompose and cause a reaction. Then, the released chlorine ions may react with the aluminum and corrode it.

For capacitors for which we guarantee cleaning, use solvents under the cleaning conditions (temperature, time, etc.) described in the specifications.

- (b) Alkaline solvents: Corrode (melt) aluminum housings.
- (c) Petroleum solvents: Deteriorate sealing rubber.
- (d) Xylene solvents: Deteriorate sealing rubber.
- (e) Acetone: Erases indications.

- (3) Be sure to dry the printed circuit boards immediately after cleaning so that the solvent does not remain between the capacitor's sealed section and the circuit board.

- (4) Manage the contamination of solvents (conductance, PH, specific gravity, amount of water, etc.)

If the solvent is contaminated, then the chlorine concentration will become high and the inside capacitor may be corroded. Control the flux concentration against the solvent to 2 %wt or less.

2.9 Mounting adhesives and coating agents

- (1) If bond or coating agents are used to fix capacitors or prevent moisture, then solvents contained in these materials may corrode the capacitors. Select solvents other than halogen compounds. Do not use chloroprene-derived polymers.

Also, if the bond and coating material containing organic solvents, such as xylene and toluene, are used, resin of the top plate of a snap-in terminal type capacitor will be dissolved.

In this case please select part number without the top plate.

- (2) If fixing or coating agents are used for capacitors, then check the following points.

- (a) Do not allow flux residue or contaminants to remain between the capacitor's sealed section and the circuit board.
- (b) Harden and dry bond or coating agents so that the solvents do not remain. Do not completely block the sealed section of a capacitor. (At least 1/3 of the sealed section must be exposed.)

2.10 Fumigation process

When electronic equipment incorporating aluminum electrolytic capacitors is exported, wooden packing materials may be fumigated using halogen compounds such as bromomethane. If drying after the fumigation process is insufficient, halogen remaining in the packing materials may be released, enter and corrode the capacitors.

If the fumigation process is carried out, then check carefully for remaining halogen after processing and drying.

Make sure not to apply the fumigation process to completely packed electronic equipment.

3. Precautions for using capacitors

3.1 Environmental Conditions

Capacitors should not be stored or used in the following environments.

- (1) Exposure to temperatures above the upper category or below the lower category temperature of the capacitor.
- (2) Direct contact with water, salt water, or oil.
- (3) High humidity conditions where water could condense on the capacitor.
- (4) Exposure to toxic gases such as hydrogen sulfide, sulfuric acid, nitric acid, chlorine, Chlorine compound, Bromine, Bromine compound or ammonia.
- (5) Exposure to ozone, radiation, or ultraviolet rays.
- (6) Vibration and shock conditions exceeding specified requirements.

3.2 Electrical Precautions

- (1) Do not touch the capacitor terminals directly.
If you touch the capacitor terminals, you will receive an electric shock. Do not touch the exposed aluminum sections of a capacitor, such as the pressure valve sections because they are not insulated.
- (2) Do not short-circuit the capacitor terminals.
Do not spill conductive solutions such as acidic or alkaline solutions on the capacitors. Otherwise, short-circuiting will occur. The circuit will malfunction and the capacitors break down.
- (3) A low-molecular-weight-siloxane which is included in a silicon material shall causes abnormal electrical characteristics.

4. Precautions for checks and maintenance

- (1) Periodically check the capacitors used in industrial equipment. When checking and maintaining capacitors, turn off the equipment and discharge the capacitors beforehand. In this case, do not apply stress to the capacitor lead terminals, etc.
- (2) Periodically check the following items.
 - (a) Significant appearance abnormalities (deformation, electrolysis leakage, etc.)
 - (b) Electrical characteristics (described in the corresponding catalog or delivery specifications)If any abnormalities are found, then replace the capacitors or take appropriate actions.

5. Emergency procedures

- (1) Capacitors of a certain size or larger are equipped with a pressure valve to release excessive pressure.
If the capacitor pressure valve is activated and gas becomes visible when using equipment, then turn off the equipment or unplug it. If the power is not turned off, then the short-circuited capacitors may damage the circuit or the gas may become liquefied and cause a short-circuit. In the worst case, secondary disasters such as equipment damage may occur.
Gases released from the capacitor's pressure valve is not fume but liquefied electrolysis.
- (2) When a pressure valve is activated, a high-temperature gas exceeding 100 °C will be released. Do not place your face close to the capacitor.
If the gas gets into your eyes or you inhale it, then immediately wash your eyes with water or gargle. If the gas comes in contact with your skin, then wash it with soap.

6. Long Term Storage

- (1) Leakage current of a capacitor increases with long storage times. The aluminum oxide film deteriorates as a function of temperature and time.
If used without reconditioning, an abnormally high current will be required to restore the oxide film.
This surge current could cause the circuit or the capacitor to fail.
Storage period is one year. When storage period is over 12 months, a capacitor should be reconditioned by applying the rated voltage in series with a 1000 Ω current limiting resistor for a time period of 30 minutes.
For storage condition, keep room temperature (5 °C to 35 °C) and humidity (45% to 85%) where direct sunshine doesn't reach.
- (2) Environmental Conditions
 - (a) Exposure to temperatures above the upper category or below the lower category temperature of the capacitor.
 - (b) Direct contact with water, salt water, or oil
 - (c) High humidity conditions where water could condense on the capacitor.
 - (d) Exposure to toxic gases such as hydrogen sulfide, sulfuric acid, nitric acid, chlorine, Chlorine compound, Bromine, Bromine compound or ammonia.
 - (e) Exposure to ozone, radiation, or ultraviolet rays.
 - (f) Vibration and shock conditions exceeding specified requirements.

7. Discarding

When discarding capacitors, use either of the following procedures.

- (1) Make holes on the capacitor or break it up completely.
Then burn it at a temperature of 800°C or higher.
If capacitors are burnt as is, then they may explode.
- (2) If you do not burn them, then ask professional waste disposer.

The precautions in using aluminum electrolytic capacitors follow the Precautionary Guidelines for the Use of Fixed Aluminum Electrolytic Capacitors for Electronic equipment, RCR-2367B issued by EIAJ in March 2002. Please refer to the above guidelines for details.

* Intellectual property right

We, Panasonic Group are providing the product and service that customers can use without anxiety, and are working positively on the protection of our products under intellectual property rights.

Representative patents relating to Conductive Polymer Hybrid Aluminum Electrolytic Capacitors are as follows :
US Patent Nos. 7497879 and 7621970 JP Patent No. 5360250

Lead Taping Radial Lead Type

● Dimensions in mm (not to scale)

Case size	Lead space (F)		
	2.5 mm	5.0 mm	7.5 mm
φ4 × 5L	B	A	
φ5 × 5L	B	A	
φ6.3 × 5L	C	A	
φ8 × 5L	C	E	
φ4 × 7L	B	A	
φ5 × 7L	B	A	
φ6.3 × 7L	C	A	
φ8 × 7L	C	E	
φ5 × 11L	C	D	
φ6.3 × 11.2L, 15L	C	D	
φ8 × 11.5L, 15L, 20L		E	
φ10 × 12.5L, 16L, 20L, 25L		F	
φ12.5 × 15L, 20L, 25L		G	
φ16 × 15L, 20L, 25L			H
φ18 × 15L, 20L, 25L			H

Figure A (Lead space: 5.0 mm / φD×L : φ4×5, 7, φ5×5, 7, φ6.3×5, 7)



Figure B (Lead space: 2.5 mm / φD×L : φ4×5, 7, φ5×5, 7)



Figure C (Lead space: 2.5 mm / φD×L : φ5×11, φ6.3×5, 7, 11.2, 15, φ8×5, 7)



Design and specifications are each subject to change without notice. Ask factory for the current technical specifications before purchase and/or use. Should a safety concern arise regarding this product, please be sure to contact us immediately.

■ Figure D (Lead space: 5 mm / $\phi D \times L$: $\phi 5 \times 11$, $\phi 6.3 \times 11.2$, 15)



■ Figure E (Lead space: 5 mm / $\phi D \times L$: $\phi 8 \times 5$, 7, 11.5, 15, 20)



■ Figure F (Lead space: 5 mm / $\phi D \times L$: $\phi 10 \times 12.5$, 16, 20, 25)



■ Figure G (Lead space: 5 mm / $\phi D \times L$: $\phi 12.5 \times 15$, 20, 25)



Design and specifications are each subject to change without notice. Ask factory for the current technical specifications before purchase and/or use. Should a safety concern arise regarding this product, please be sure to contact us immediately.

■ Figure H (Lead space: 7.5 mm / $\phi D \times L$: $\phi 16 \times 15, 20, 25, \phi 18 \times 15, 20, 25$)

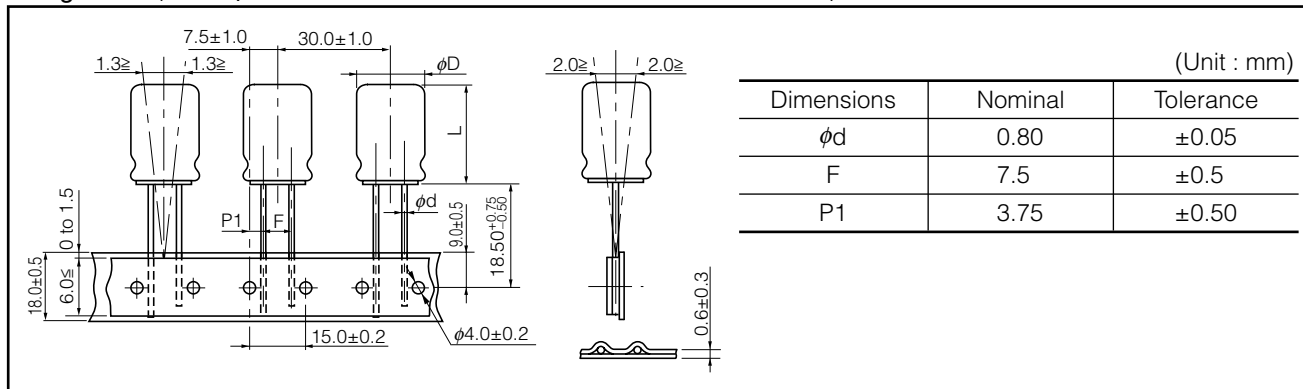

■ Packaging Specifications

Dimensions (mm)	Dimensions of Outer Carton Box				
	$\phi 4$ to $\phi 5$	$\phi 6.3$	$\phi 8$	$\phi 10, \phi 12.5$	$\phi 16, \phi 18$
a	340 max.	340 max.	340 max.	340 max.	340 max.
b	to 55 max.	to 55 max.	to 55 max.	55 to 66 max.	62 to 75 max.
c	170 to 210 max.	270 max.	230 max.	170 to 270 max.	225 to 310 max.
Packaging Quantity	2000 pcs.	2000 pcs.	1000 pcs.	500 pcs.	250 pcs.

Lead Forming Type (Snap-in)

Lead formed Aluminium Electrolytic Capacitor for self mounting, for rationalization and upgrade of soldering process.



* Direction of bending shape is not specified

■ Dimensions in mm (not to scale)

(Unit : mm)

Dia ϕD	H1 ± 0.5	H2	H3	F ± 0.5	P	E max.	ϕd	for PWB	
								hole dia. ϕ	thickness
5	4.5	2.7	2.5	5.0	1.0	1.0	0.5	0.9	1.6
6.3	4.5	2.7	2.5	5.0	1.0	1.0	0.5	1.0	1.6
8	4.5	2.7	2.5	5.0	1.0	1.0	0.6	1.0	1.6
10	4.5	2.7		5.0	1.0/0.9	1.0	0.6/0.8	1.0 / 1.1	1.6
12.5	4.5	2.7		5.0	1.0/0.9	1.0	0.6/0.8	1.0 / 1.1	1.6
16	4.5	2.7		7.5	0.9	1.0	0.8	1.1	1.6
18	4.5	2.7		7.5	0.9	1.0	0.8	1.1	1.6

■ Series KA/KS Dimensions in mm (not to scale)

(Unit : mm)

Dia ϕD	H1 ± 0.5	H2	H3 ± 0.3	F ± 0.5	P	E max.	ϕd	for PWB	
								hole dia. ϕ	thickness
4	4.5	2.7	1.5	5.0	0.95	1.0	0.45	0.9	1.6
5	4.5	2.7	1.5	5.0	0.95	1.0	0.45	0.9	1.6
6.3	4.5	2.7	1.5	5.0	0.95	1.0	0.45	0.9	1.6
8	4.5	2.7	1.5	5.0	0.95	1.0	0.45	0.9	1.6

Discontinued Series (not recommended for new design)

Aluminum Electrolytic Capacitors (Radial Lead Type)

Discontinued Product						Replacement			
Series	Part No.	Endurance	Features	Rated.W.V. (V)	Capacitance (μ F)	Series	Endurance		
S SW S(High voltage)	ECEA--S-----	+ 85 °C 1000 h	Standard	10 to 50	1 to 100	M	+ 85 °C 2000 h		
S Bi-polar	ECEA--N----S	+ 85 °C 2000 h	Bi-polar Standard	4 to 100	0.1 to 1000	SU-BP	+ 85 °C 2000 h		
SU	ECEA--U-----	+ 85 °C 2000 h	Standard	6.3 to 450	0.1 to 15000	M	+ 85 °C 2000 h		
K	ECEA--K-----	+ 85 °C 1000 h	Height 7 mm	6.3 to 50	0.1 to 100	KA	+ 85 °C 1000 h		
KS(ϕ 3)	ECEA--KK----	+ 85 °C 1000 h	Height 5 mm ϕ 3x5	4 to 50	0.1 to 22	Available upon request			
KG	ECEA--KG-----	+105 °C 1000 h	Height 7 mm	6.3 to 50	0.1 to 220	GA	+105 °C 1000 h		
SS	ECEA--SS---	+ 85 °C 2000 h	Low profile	6.3 to 50	3.3 to 4700	Available upon request			
Z	ECEA--Z----	+ 85 °C 2000 h	Low impedance	6.3 to 50	0.1 to 2200	FC	+105 °C 1000 to 5000 h		
HF	ECEA--F----	+105 °C 2000 h	Low impedance	10 to 63	22 to 2200				
HFS	ECEA--FS---	+105 °C 1000 to 2000 h	Low impedance	6.3 to 63	0.47 to 4700				
HFE	ECEA--FE---	+105 °C 2000 h	Low impedance	6.3 to 100	3.3 to 15000				
HFG	ECA--FG----	+105 °C 2000 to 5000 h	Low impedance	6.3 to 63	0.1 to 15000				
HFQ	ECA--FQ----	+105 °C 1000 to 2000 h	Low impedance	6.3 to 63	6.8 to 15000				
HFZ	ECA--FZ----	+105 °C 5000 h	Low impedance	6.3 to 35	56 to 5600				
KF	ECA--KF----	+105 °C 1000 h	Height 7 mm, Low impedance	6.3 to 35	1 to 120				
ESM	ECEA--E---M	+ 85 °C 2000 h	Low impedance	10 to 50	0.1 to 220				
FA	EEUFA-----	+105 °C 2000 to 5000 h	Low impedance	6.3 to 63	68 to 15000				
FB	EEUFB-----	+105 °C 1000 to 2000 h	Low impedance	10 to 50	0.47 to 10000				
NHE	ECEA--GE---	+105 °C 2000 h	Longlife	6.3 to 450	0.1 to 15000			NHG	+105 °C 1000 to 2000 h
MH	ECA--MH---	+105 °C 1000 h	Longlife	6.3 to 100	0.1 to 22000				
NH	ECEA--G---S	+105 °C 2000 h	Longlife	6.3 to 100	0.47 to 4700				
NE	ECA--TE---	+105 °C 5000 to 7000 h	Longlife	10 to 63	0.47 to 3300	EB	+105 °C 5000 to 10000 h		
NX	ECEA--NX---	+105 °C 5000 h	Longlife	6.3 to 50	0.047 to 2200	TA	+125 °C 2000 h		
3H	ECEA--T----	+125 °C 1000 h	High reliability	10 to 63	1 to 1000	Available upon request			
MG	EEUMG----	+ 85 °C 2000 h	High ripple	160 to 450	2.2 to 470	NHG	+105 °C 1000 to 2000 h		
TH	ECEA--V---T	+105 °C 1000 h	Fixed time-interval circuit	10, 16, 25, 50	1 to 2200	M	+85 °C 2000 h		
MT	ECEA--M---T	+ 85 °C 1000 h	Time constant circuit	6.3 to 50	47 to 2200				
MS	ECEA--M---	+ 85 °C 2000 h	Low LC	10 to 50	0.1 to 100				
GA	EEUGA-----	+105 °C 2000 h	+105°C Standard	6.3 to 50	0.1 to 15000	NHG	+105 °C 1000 to 2000 h		
EA	EEUEA-----	+105 °C 5000 h	Longlife	160 to 450	10 to 150	EE	+105 °C 8000 to 10000 h		
Horizontal defection current correction	ECEA--W----	+ 85 °C 2000 h	Horizontal defection current correction for TV	25	3.5 to 10	Not available			

Check Panasonic website for discontinued / revised product series specification.

<http://panasonic.net/id/>

Panasonic

MEMO

For more Information please contact the respective sales office of factory

Factory

Capacitor Business Division

Automotive & Industrial Systems Company, Panasonic Corporation

25, Nishinaka, Kowata, Uji, Kyoto, 611-8585 JAPAN TEL 81-774-32-1111

SALES OFFICES

Automotive & Industrial Systems Company

Panasonic Corporation (JAPAN)

Industrial Marketing & Sales Division
1006 Kadoma Kadoma-shi, Osaka 571-8506, JAPAN

North & Latin Americas

PIDSA

Panasonic Industrial Devices Sales Company of America,
A Division of Panasonic Corporation of North America
Industrial Components Division
Two Riverfront Plaza, 7th Floor Newark, NJ 07102-2550, U.S.A.
Tel: 1-800-344-2112

Panasonic Canada Inc.
5770 Ambler Drive Mississauga, Ontario L4W 2T3 CANADA
Tel: 1-905-238-2311

Panasonic do Brasil Limitada
Av. do Cafe, 277-Bloco A-8 andar, CEP04311-900,
Sao Paulo, SP, BRASIL
Tel: 55-11-3889-4145

SANYO Electronic Device (U.S.A.) Corporation
A Division of SANYO North America Corporation
San Diego Headquarter
2055 Sanyo Ave., San Diego ,CA 92154, U.S.A.
Tel: 1-619-671-4356

Cupertino office
10900 North Tantau Ave., Ste #120 Cupertino, CA 95014, U.S.A.
Tel: 1-408-861-3959

Dallas sales office
2600 Network Blvd, 6th Floor, Frisco, TX 75034, U.S.A.
Tel: 1-469-362-5465

Europe

PIDSEU

Panasonic Industrial Devices Sales Europe GmbH
Winsberggring 15, D-22525 Hamburg, GERMANY
Tel: 49-40-85386-370

PIDSEU-UK

Panasonic Industrial Devices Sales Europe GmbH UK Branch
Willoughby Road, Bracknell, Berkshire RG12 8FP, U.K.
Tel: 44-1344-862-444

PIDSEU-Paris

Panasonic Industrial Devices Sales Europe GmbH Paris Office
8/10 Rue des petits Ruisseaux, 91370 Verrieres-Le-Buisson,
FRANCE
Tel: 33-(0)-1-60-13-57-00

PIDSEU-Milan

Panasonic Industrial Devices Sales Europe GmbH Milan Office
C/O Panasonic Italia S.p.A. Viale Dell'Innovazione 3-20125
Milano, ITALY
Tel: 39-02-6788-321

PIDSEU-Barcelona

Panasonic Industrial Devices Sales Europe GmbH Barcelona Office
Parque Empresarial @ Sant Cugat, Via Augusta 15_25 Edificio
B2 Planta 4 Oficina 17, 08174 Sant Cugat del Vales, Barcelona,
SPAIN
Tel: 34-93-504-3010

PIDSEU-Helsinki

Panasonic Industrial Devices Sales Europe GmbH Helsinki Sales Office
Urho Kekkonen Katu 7B, 00100 Helsinki, Finland
Tel: 358-9-6898-4150

East Asia and China

PIDSCN

Panasonic Industrial Devices Sales (China) Co.,Ltd
Floor 7, China Insurance Building, 166 East Road LujaZui,
PuDong New District, Shanghai 200120, CHINA
Tel: 86-21-3855-2000

PSIDSHK

Panasonic Shun Hing Industrial Devices Sales (Hong Kong) Co.,Ltd.
Top Floor South Wing Chinachem Golden Plaza 77 Mody
Road Tsim Sha Tsui East Kowloon, HONG KONG
Tel: 852-2529-7322

PSIDSSZN

Panasonic SH Industrial Devices Sales (Shenzhen) Co.,Ltd.
8/F, Tower Three, Kerry Plaza, 1-1zhongxin 4th Road,
Futian District, Shenzhen 518048, CHINA
Tel: 86-755-8255-8888

SANYO Electric (Hong Kong) Ltd.

SANYO Electronic Components Company
Hong Kong Headquarter
Level 27, Tower 1, Kowloon Commerce Centre, 51 Kwai
Cheong Road, Kwai Chung, N.T., Hong Kong
Tel: 852-2484-5000

Beijing representative office

3th Floor, Tower, C Office Park, No.5, Jinghua South Street,
Chaoyang District, Beijing, P.R China, 100025
Tel: 86-10-6562-6688

PIDSTW

Panasonic Industrial Devices Sales Taiwan Co.,Ltd.
12F, No.9, SongGao Rd., Taipei 110, TAIWAN, R.O.C.
Tel: 886-2-2757-1900

SANYO Electric (Hong Kong) Ltd.

SANYO Electronic Components Company
Taiwan branch
10/F, No.101, Sec.2, Nanjing E. Rd., Jhongshan District,
Taipei City 104, Taiwan(R.O.C.)
Tel: 886-2-2536-1855

PIDSKR

Panasonic Industrial Devices Sales Korea Co.,Ltd.
DONGIL Tower 4-6F, 1004, Daechi dong, 114-38,
Teheran-ro, Gangnam-gu, Seoul, KOREA
Tel: 82-2-795-9600

South Asia

PIDS

Panasonic Industrial Devices Sales Asia Pte.Ltd.
No.3 Bedok South Road Singapore 469269,
THE REPUBLIC OF SINGAPORE
Tel: 65-6299-9181

PIDSMY

Panasonic Industrial Devices Sales (M) Sdn. Bhd.
15th Floor, Menara IGB, Mid Valley City, Lingkaran Syed
Putra, 59200 Kuala Lumpur, MALAYSIA
Tel: 60-3-2297-6888

PIDSTH

Panasonic Industrial Devices Sales (Thailand) Co.,Ltd.
252/133 Muang Thai-Phatra Complex Bld., 31st Fl.,
Rachadaphisek Rd., Huaykwang, Bangkok 10320, THAILAND
Tel: 66-2693-3403-21

PI-INDD

Panasonic Industrial Devices Sales India
7th Floor ABW Tower, Sector 25, IFFCO Chowk, MG Road,
Gurgaon-122001, Haryana, INDIA
Tel: 91-124-459-6600

CAUTION AND WARNING

1. The electronic components contained in this catalog are designed and produced for use in home electric appliances, office equipment, information equipment, communications equipment, and other general purpose electronic devices.
Before use of any of these components for equipment that requires a high degree of safety, such as medical instruments, aerospace equipment, disaster-prevention equipment, security equipment, vehicles (automobile, train, vessel), please be sure to contact our sales representative.
2. When applying one of these components for equipment requiring a high degree of safety, no matter what sort of application it might be, be sure to install a protective circuit or redundancy arrangement to enhance the safety of your equipment. In addition, please carry out the safety test on your own responsibility.
3. When using our products, no matter what sort of equipment they might be used for, be sure to make a written agreement on the specifications with us in advance.
4. Technical information contained in this catalog is intended to convey examples of typical performances and/or applications and is not intended to make any warranty with respect to the intellectual property rights or any other related rights of our company or any third parties nor grant any license under such rights.
5. In order to export products in this catalog, the exporter may be subject to the export license requirement under the Foreign Exchange and Foreign Trade Law of Japan.
6. No ozone-depleting substances (ODSs) under the Montreal Protocol are used in the manufacturing processes of Automotive & Industrial Systems Company, Panasonic Corporation.

● Please contact

● Factory

Capacitor Business Division
Automotive & Industrial Systems Company
Panasonic Corporation

25 Nishinaka, Kowata, Uji City, Kyoto

611-8585, JAPAN

Tel : 81-774-32-1111

The information in this catalog is valid as of July 2014.

Mouser Electronics

Authorized Distributor

Click to View Pricing, Inventory, Delivery & Lifecycle Information:

Panasonic:

[ECE-A1HKS3R3](#) [EEU-FC1J221XB](#) [EEU-EB2V100](#) [ECE-A1VKA100B](#) [EEU-EB1J101](#) [EEU-EB2D101S](#) [EEU-EB2W220B](#) [EEU-FC1A470](#) [EEU-FC2A4R7](#) [EEU-FC2A471](#) [EEA-FC1E100](#) [EEU-FC0J331B](#) [EEU-EB2D101](#) [ECA-1HHG102B](#) [EEU-FC2A330B](#) [EEU-FM1E101](#) [ECE-A1VKS3R3](#) [EEU-FM1V152L](#) [EEU-FM1H101](#) [EEU-EB2E330](#) [EEU-EB2G470S](#) [EEU-FC1A472L](#) [EEU-FM0J102](#) [EEU-FM1H151](#) [EEU-FM1H560](#) [EEU-FM1V561L](#) [EEU-FC1V151B](#) [ECE-A1CKS470](#) [EEU-FC1A561](#) [EEU-FC1H330H](#) [EEU-FM1V331](#) [EEU-FM1V102B](#) [EEU-FM1V151](#) [EEU-FC1J471B](#) [ECA-1EHG470I](#) [EEU-EB2V101](#) [EEU-FC1H680B](#) [ECA-1HHG4R7I](#) [EEU-EB1V330SH](#) [ECE-A0JKS470I](#) [ECE-A1CKA101B](#) [EEU-FC1J220B](#) [EEU-EB2G330S](#) [ECE-A1HKA4R7I](#) [ECA-2GHHG100](#) [EEU-EB2C221S](#) [ECA-1AHG471B](#) [ECA-1VHHG222B](#) [ECA-2GHHG3R3](#) [ECE-A1CKS470B](#) [EEU-FM1E221B](#) [EEU-FC1A471B](#) [EEU-FC1J121B](#) [EEU-EB1E331B](#) [EEU-EB1H470SH](#) [EEU-FC1C272B](#) [EEU-FM1E102B](#) [EEU-EB2V680S](#) [ECA-1JHG471B](#) [EEU-FM1E331](#) [EEU-FC2A560](#) [EEA-FC1C560](#) [EEU-EB1J330H](#) [EEU-FM0J682](#) [EEU-FM1H681L](#) [EEU-EB2C470](#) [EEU-FC1V390H](#) [EEU-EB1A221](#) [ECA-1JHG100B](#) [EEU-FC2A2R2](#) [EEU-FM1C222](#) [EEU-FM1C222B](#) [EEU-FM1C392](#) [EEU-FM1E152](#) [ECA-0JHG102B](#) [ECA-0JHG102BJ](#) [ECA-0JHG103B](#) [ECA-0JHG221B](#) [ECA-0JHG221I](#) [ECA-0JHG222B](#) [ECA-0JHG331B](#) [ECA-0JHG331I](#) [ECA-0JHG332B](#) [ECA-0JHG471B](#) [ECA-0JHG471I](#) [ECA-0JHG472B](#) [ECA-0JHG682B](#) [ECA-1AHG103B](#) [ECA-1AHG221B](#) [ECA-1AHG221I](#) [ECA-1AHG222B](#) [ECA-1AHG331B](#) [ECA-1AHG331I](#) [ECA-1AHG332B](#) [ECA-1AHG471BJ](#) [ECA-1AHG472B](#) [ECA-1AHG682B](#) [ECA-1CHG101B](#) [ECA-1CHG101I](#) [ECA-1CHG102B](#)



Компания «ЭлектроПласт» предлагает заключение долгосрочных отношений при поставках импортных электронных компонентов на взаимовыгодных условиях!

Наши преимущества:

- Оперативные поставки широкого спектра электронных компонентов отечественного и импортного производства напрямую от производителей и с крупнейших мировых складов;
- Поставка более 17-ти миллионов наименований электронных компонентов;
- Поставка сложных, дефицитных, либо снятых с производства позиций;
- Оперативные сроки поставки под заказ (от 5 рабочих дней);
- Экспресс доставка в любую точку России;
- Техническая поддержка проекта, помощь в подборе аналогов, поставка прототипов;
- Система менеджмента качества сертифицирована по Международному стандарту ISO 9001;
- Лицензия ФСБ на осуществление работ с использованием сведений, составляющих государственную тайну;
- Поставка специализированных компонентов (Xilinx, Altera, Analog Devices, Intersil, Interpoint, Microsemi, Aeroflex, Peregrine, Syfer, Eurofarad, Texas Instrument, Miteq, Cobham, E2V, MA-COM, Hittite, Mini-Circuits, General Dynamics и др.);

Помимо этого, одним из направлений компании «ЭлектроПласт» является направление «Источники питания». Мы предлагаем Вам помощь Конструкторского отдела:

- Подбор оптимального решения, техническое обоснование при выборе компонента;
- Подбор аналогов;
- Консультации по применению компонента;
- Поставка образцов и прототипов;
- Техническая поддержка проекта;
- Защита от снятия компонента с производства.



Как с нами связаться

Телефон: 8 (812) 309 58 32 (многоканальный)

Факс: 8 (812) 320-02-42

Электронная почта: org@eplast1.ru

Адрес: 198099, г. Санкт-Петербург, ул. Калинина, дом 2, корпус 4, литера А.