

Power SMD LED PLCC-2

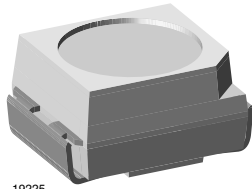

19225

DESCRIPTION

The VLM.33.. series is an advanced modification of the Vishay VLM.33.. series. It is designed to incorporate larger chips, therefore, capable of withstanding a 50 mA drive current.

The package of the VLM.33.. is the PLCC-2.

It consists of a lead frame which is embedded in a white thermoplast. The reflector inside this package is filled up with clear epoxy.

PRODUCT GROUP AND PACKAGE DATA

- Product group: LED
- Product series: SMD Power
- Package: PLCC-2
- Angle of half intensity: $\pm 60^\circ$

FEATURES

- Utilizing (AS) AlInGaP technology
- Available in 8 mm tape
- Luminous intensity and color categorized per packing unit
- Luminous intensity ratio per packing unit $I_{Vmax}/I_{Vmin} \leq 1.6$
- Thermal resistance $R = 400 \text{ K/W}$
- ESD-withstand voltage: up to 2 kV according to JESD22-A114-B
- Lead (Pb)-free device
- Preconditioning: acc. to JEDEC Level 2a
- Compatible with Reflow, vapor phase and wave solder processes according to CECC 00802 and J-STD-020C
- Component in accordance to RoHS 2002/95/EC and WEEE 2002/96/EC
- Automotive qualified AEC-Q101



APPLICATIONS

- Traffic signals and signs
- Interior and exterior lighting
- Dashboard illumination
- Indicator and backlighting purposes for audio, video, LCDs switches, symbols, illuminated advertising etc

PARTS TABLE

| PART | COLOR, LUMINOUS INTENSITY | TECHNOLOGY |
|-----------------|--|-----------------|
| VLMR33T1U2-GS08 | Amber, $I_V = (280 \text{ to } 710) \text{ mcd}$ | AllnGaP on GaAs |
| VLMR33T1U2-GS18 | Amber, $I_V = (280 \text{ to } 710) \text{ mcd}$ | AllnGaP on GaAs |
| VLMR33R2U2-GS08 | Amber, $I_V = (140 \text{ to } 710) \text{ mcd}$ | AllnGaP on GaAs |
| VLMR33R2U2-GS18 | Amber, $I_V = (140 \text{ to } 710) \text{ mcd}$ | AllnGaP on GaAs |
| VLMS33S1T2-GS08 | Super red, $I_V = (180 \text{ to } 450) \text{ mcd}$ | AllnGaP on GaAs |
| VLMS33S1T2-GS18 | Super red, $I_V = (180 \text{ to } 450) \text{ mcd}$ | AllnGaP on GaAs |
| VLMS33S1U1-GS08 | Super red, $I_V = (180 \text{ to } 560) \text{ mcd}$ | AllnGaP on GaAs |
| VLMS33S1U1-GS18 | Super red, $I_V = (180 \text{ to } 560) \text{ mcd}$ | AllnGaP on GaAs |
| VLMO33S1T2-GS08 | Soft orange, $I_V = (180 \text{ to } 450) \text{ mcd}$ | AllnGaP on GaAs |
| VLMO33S1T2-GS18 | Soft orange, $I_V = (180 \text{ to } 450) \text{ mcd}$ | AllnGaP on GaAs |
| VLMO33T1U2-GS08 | Soft orange, $I_V = (280 \text{ to } 710) \text{ mcd}$ | AllnGaP on GaAs |
| VLMO33T1U2-GS18 | Soft orange, $I_V = (280 \text{ to } 710) \text{ mcd}$ | AllnGaP on GaAs |
| VLMO33R2U2-GS08 | Soft orange, $I_V = (140 \text{ to } 710) \text{ mcd}$ | AllnGaP on GaAs |

| PARTS TABLE | | |
|-----------------|--|-----------------|
| PART | COLOR, LUMINOUS INTENSITY | TECHNOLOGY |
| VLMO33R2U2-GS18 | Soft orange, $I_V = (140 \text{ to } 710) \text{ mcd}$ | AllnGaP on GaAs |
| VLMY33T1U2-GS08 | Yellow, $I_V = (280 \text{ to } 710) \text{ mcd}$ | AllnGaP on GaAs |
| VLMY33T1U2-GS18 | Yellow, $I_V = (280 \text{ to } 710) \text{ mcd}$ | AllnGaP on GaAs |
| VLMY33R2U2-GS08 | Yellow, $I_V = (140 \text{ to } 710) \text{ mcd}$ | AllnGaP on GaAs |
| VLMY33R2U2-GS18 | Yellow, $I_V = (140 \text{ to } 710) \text{ mcd}$ | AllnGaP on GaAs |

| ABSOLUTE MAXIMUM RATINGS ¹⁾ VLM.33.. | | | | |
|---|---|------------|---------------|------------------|
| PARAMETER | TEST CONDITION | SYMBOL | VALUE | UNIT |
| Reverse voltage ²⁾ | | V_R | 5 | V |
| DC Forward current | $T_{amb} \leq 73 \text{ }^\circ\text{C}$ (400 K/W) | I_F | 50 | mA |
| Power dissipation | | P_V | 130 | mW |
| Junction temperature | | T_j | 125 | $^\circ\text{C}$ |
| Operating temperature range | | T_{amb} | - 40 to + 100 | $^\circ\text{C}$ |
| Storage temperature range | | T_{stg} | - 40 to + 100 | $^\circ\text{C}$ |
| Thermal resistance junction/ ambient | mounted on PC board (pad size > 16 mm ²) | R_{thJA} | 400 | K/W |

Note:

¹⁾ $T_{amb} = 25 \text{ }^\circ\text{C}$, unless otherwise specified

²⁾ Driving the LED in reverse direction is suitable for a short term application

| OPTICAL AND ELECTRICAL CHARACTERISTICS ¹⁾ VLMR33.., AMBER | | | | | | | |
|--|-----------------------|------------|-----------------|-----|----------|-----|---------------|
| PARAMETER | TEST CONDITION | PART | SYMBOL | MIN | TYP. | MAX | UNIT |
| Luminous intensity | $I_F = 30 \text{ mA}$ | VLMR33T1U2 | I_V | 280 | | 710 | mcd |
| | | VLMR33R2U2 | I_V | 140 | | 710 | mcd |
| Luminous flux/Luminous intensity | | | ϕ_V/I_V | | 3 | | mlm/mcd |
| Dominant wavelength | $I_F = 30 \text{ mA}$ | | λ_d | 611 | 617 | 622 | nm |
| Peak wavelength | $I_F = 30 \text{ mA}$ | | λ_p | | 624 | | nm |
| Spectral bandwidth at 50 % $I_{rel \text{ max}}$ | $I_F = 30 \text{ mA}$ | | $\Delta\lambda$ | | 18 | | nm |
| Angle of half intensity | $I_F = 30 \text{ mA}$ | | φ | | ± 60 | | deg |
| Forward voltage | $I_F = 30 \text{ mA}$ | | V_F | 1.7 | 2.0 | 2.5 | V |
| Reverse current | $V_R = 5 \text{ V}$ | | I_R | | 0.01 | 10 | μA |

Note:

¹⁾ $T_{amb} = 25 \text{ }^\circ\text{C}$, unless otherwise specified

| OPTICAL AND ELECTRICAL CHARACTERISTICS¹⁾ VLMS33.., SUPER RED | | | | | | | |
|--|-----------------------|------------|-----------------|-----|----------|-----|---------------|
| PARAMETER | TEST CONDITION | PART | SYMBOL | MIN | TYP. | MAX | UNIT |
| Luminous intensity | $I_F = 30 \text{ mA}$ | VLMS33S1T2 | I_V | 180 | | 450 | mcd |
| | | VLMS33S1U1 | I_V | 180 | | 560 | mcd |
| Luminous flux/Luminous intensity | | | ϕ_V/I_V | | 3 | | mlm/mcd |
| Dominant wavelength | $I_F = 30 \text{ mA}$ | | λ_d | 626 | 630 | 638 | nm |
| Peak wavelength | $I_F = 30 \text{ mA}$ | | λ_p | | 641 | | nm |
| Spectral bandwidth at 50 % $I_{rel \text{ max}}$ | $I_F = 30 \text{ mA}$ | | $\Delta\lambda$ | | 17 | | nm |
| Angle of half intensity | $I_F = 30 \text{ mA}$ | | φ | | ± 60 | | deg |
| Forward voltage | $I_F = 30 \text{ mA}$ | | V_F | 1.7 | 2.0 | 2.5 | V |
| Reverse current | $V_R = 5 \text{ V}$ | | I_R | | 0.01 | 10 | μA |

Note:

¹⁾ $T_{amb} = 25 \text{ }^\circ\text{C}$, unless otherwise specified

| OPTICAL AND ELECTRICAL CHARACTERISTICS¹⁾ VLMO33.., SOFT ORANGE | | | | | | | |
|--|-----------------------|------------|-----------------|-----|----------|-----|---------------|
| PARAMETER | TEST CONDITION | PART | SYMBOL | MIN | TYP. | MAX | UNIT |
| Luminous intensity | $I_F = 30 \text{ mA}$ | VLMO33S1T2 | I_V | 180 | | 450 | mcd |
| | | VLMO33T1U2 | I_V | 280 | | 710 | mcd |
| | | VLMO33R2U2 | I_V | 140 | | 710 | mcd |
| Luminous flux/Luminous intensity | | | ϕ_V/I_V | | 3 | | mlm/mcd |
| Dominant wavelength | $I_F = 30 \text{ mA}$ | | λ_d | 600 | 605 | 611 | nm |
| Peak wavelength | $I_F = 30 \text{ mA}$ | | λ_p | | 611 | | nm |
| Spectral bandwidth at 50 % $I_{rel \text{ max}}$ | $I_F = 30 \text{ mA}$ | | $\Delta\lambda$ | | 17 | | nm |
| Angle of half intensity | $I_F = 30 \text{ mA}$ | | φ | | ± 60 | | deg |
| Forward voltage | $I_F = 30 \text{ mA}$ | | V_F | 1.7 | 2.0 | 2.5 | V |
| Reverse current | $V_R = 5 \text{ V}$ | | I_R | | 0.01 | 10 | μA |

Note:

¹⁾ $T_{amb} = 25 \text{ }^\circ\text{C}$, unless otherwise specified

| OPTICAL AND ELECTRICAL CHARACTERISTICS¹⁾ VLMY33.., YELLOW | | | | | | | |
|---|-----------------------|------------|-----------------|-----|----------|-----|---------------|
| PARAMETER | TEST CONDITION | PART | SYMBOL | MIN | TYP. | MAX | UNIT |
| Luminous intensity | $I_F = 30 \text{ mA}$ | VLMY33T1U2 | I_V | 280 | | 710 | mcd |
| | | VLMY33R2U2 | I_V | 140 | | 710 | mcd |
| Luminous flux/Luminous intensity | | | ϕ_V/I_V | | 3 | | mlm/mcd |
| Dominant wavelength | $I_F = 30 \text{ mA}$ | | λ_d | 583 | 588 | 594 | nm |
| Peak wavelength | $I_F = 30 \text{ mA}$ | | λ_p | | 590 | | nm |
| Spectral bandwidth at 50 % $I_{rel \text{ max}}$ | $I_F = 30 \text{ mA}$ | | $\Delta\lambda$ | | 18 | | nm |
| Angle of half intensity | $I_F = 30 \text{ mA}$ | | φ | | ± 60 | | deg |
| Forward voltage | $I_F = 30 \text{ mA}$ | | V_F | 1.7 | 2.0 | 2.5 | V |
| Reverse current | $V_R = 5 \text{ V}$ | | I_R | | 0.01 | 10 | μA |

Note:

¹⁾ $T_{amb} = 25 \text{ }^\circ\text{C}$, unless otherwise specified



| COLOR CLASSIFICATION | | | | | | |
|-----------------------------|--------------------------|-----|-------------|-----|--------|-----|
| GROUP | DOMINANT WAVELENGTH (NM) | | | | | |
| | AMBER | | SOFT ORANGE | | YELLOW | |
| | MIN | MAX | MIN | MAX | MIN | MAX |
| 1 | 611 | 618 | 598 | 601 | 581 | 584 |
| 2 | 614 | 622 | 600 | 603 | 583 | 586 |
| 3 | | | 602 | 605 | 585 | 588 |
| 4 | | | 604 | 607 | 587 | 590 |
| 5 | | | 606 | 609 | 589 | 592 |
| 6 | | | 608 | 611 | 591 | 594 |

Note:
Wavelengths are tested at a current pulse duration of 25 ms and an accuracy of ± 1 nm.

| LUMINOUS INTENSITY CLASSIFICATION | | | |
|--|--------------------------|----------|-----|
| GROUP | LUMINOUS INTENSITY (MCD) | | |
| | STANDARD | OPTIONAL | MAX |
| P | 1 | 45 | 56 |
| | 2 | 56 | 71 |
| Q | 1 | 71 | 90 |
| | 2 | 90 | 112 |
| R | 1 | 112 | 140 |
| | 2 | 140 | 180 |
| S | 1 | 180 | 224 |
| | 2 | 224 | 280 |
| T | 1 | 280 | 355 |
| | 2 | 355 | 450 |
| U | 1 | 450 | 560 |
| | 2 | 560 | 710 |

| CROSSING TABLE | |
|-----------------------|-------------|
| VISHAY | OSRAM |
| VLMS33S1T2 | LST67B-S1T2 |
| VLMS33S1U1 | LST67B-T1U1 |

Note:
Luminous intensity is tested at a current pulse duration of 25 ms and an accuracy of ± 11 %.

The above type Numbers represent the order groups which include only a few brightness groups. Only one group will be shipped on each reel (there will be no mixing of two groups on each reel).

In order to ensure availability, single brightness groups will not be orderable.

In a similar manner for colors where wavelength groups are measured and binned, single wavelength groups will be shipped on any one reel.

In order to ensure availability, single wavelength groups will not be orderable.

TYPICAL CHARACTERISTICS

$T_{amb} = 25\text{ }^{\circ}\text{C}$, unless otherwise specified

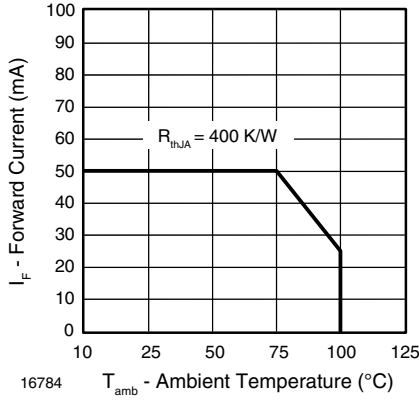

Figure 1. Forward Current vs. Ambient Temperature

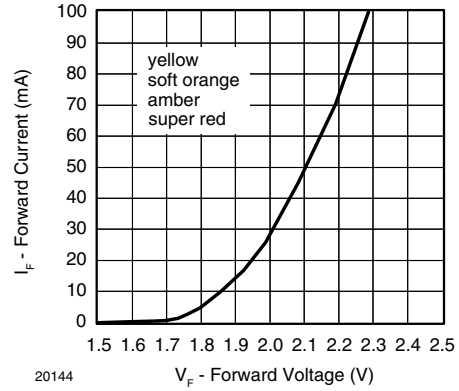

Figure 4. Forward Current vs. Forward Voltage



Figure 2. Forward Current vs. Pulse Length



Figure 5. Relative Intensity vs. Wavelength

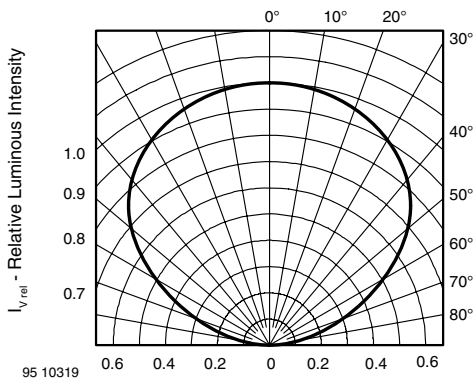

Figure 3. Rel. Luminous Intensity vs. Angular Displacement

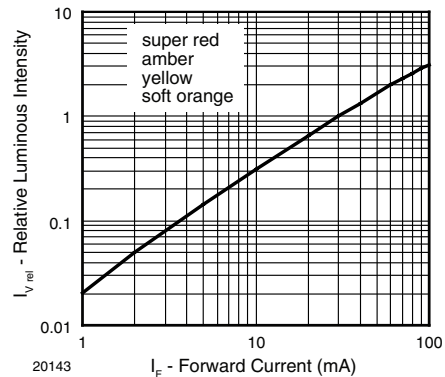

Figure 6. Relative Luminous Intensity vs. Forward Current

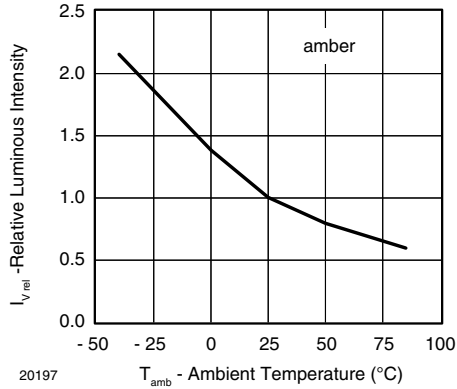

Figure 7. Relative Luminous Intensity vs. Amb. Temperature

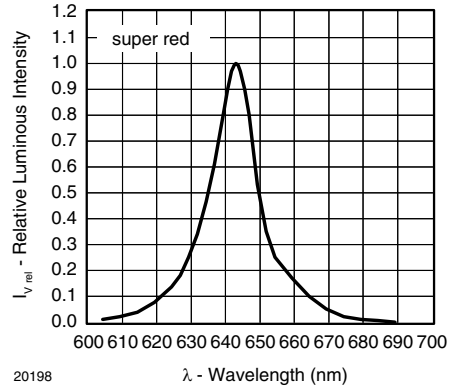

Figure 10. Relative Intensity vs. Wavelength

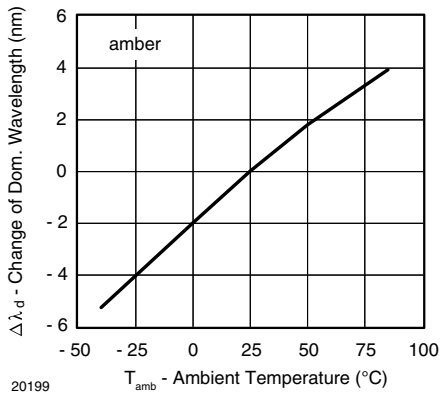

Figure 8. Change of Dominant Wavelength vs. Ambient Temperature

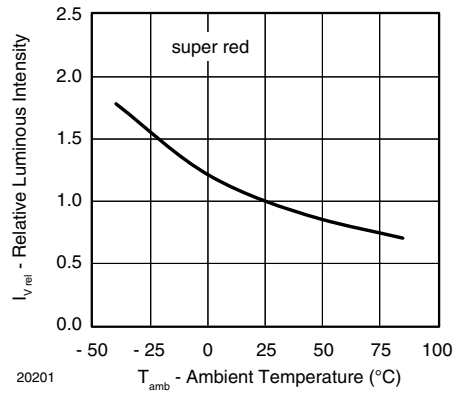

Figure 11. Relative Luminous Intensity vs. Amb. Temperature

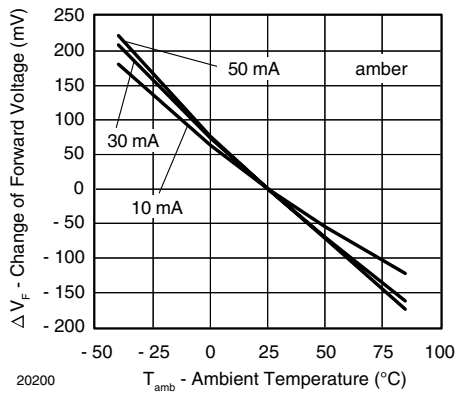

Figure 9. Change of Forward Voltage vs. Ambient Temperature

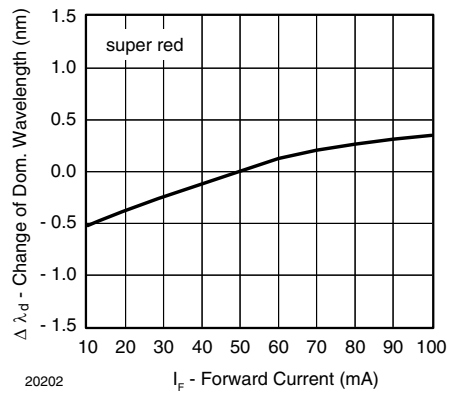
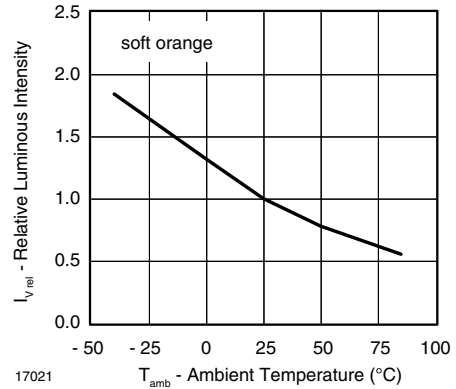

Figure 12. Change of Dominant Wavelength vs. Forward Current



20203
Figure 13. Change of Dominant Wavelength vs. Ambient Temperature



17021
Figure 16. Relative Luminous Intensity vs. Amb. Temperature

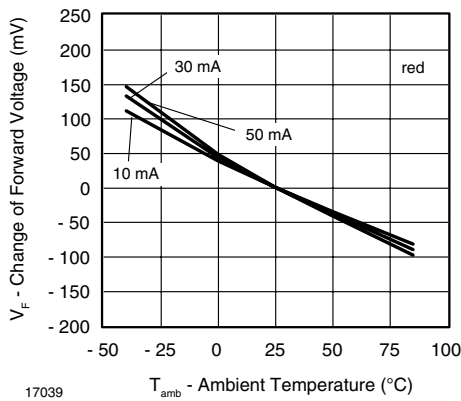

17039
Figure 14. Change of Forward Voltage vs. Ambient Temperature

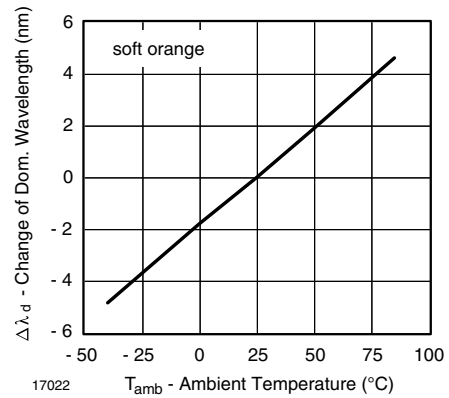

17022
Figure 17. Change of Dominant Wavelength vs. Ambient Temperature

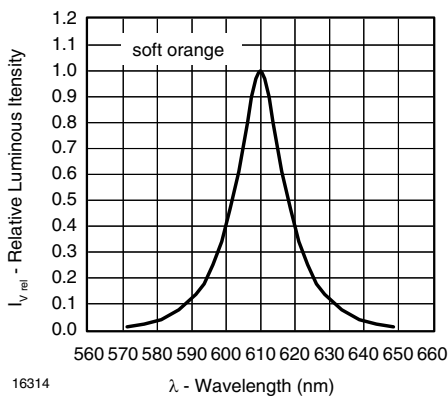

16314
Figure 15. Relative Intensity vs. Wavelength

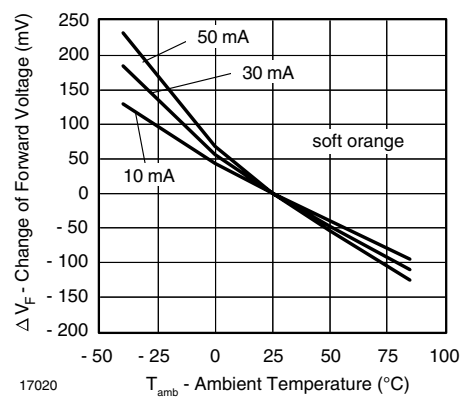

17020
Figure 18. Change of Forward Voltage vs. Ambient Temperature



Figure 19. Relative Intensity vs. Wavelength

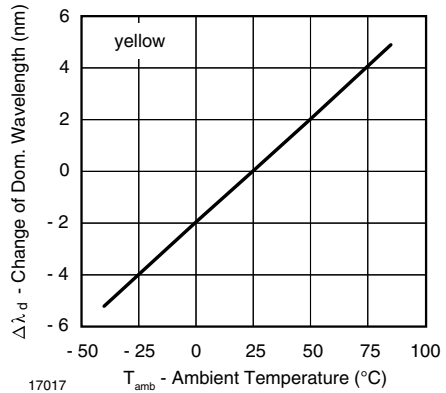

Figure 21. Change of Dominant Wavelength vs. Ambient Temperature



Figure 20. Relative Luminous Intensity vs. Amb. Temperature

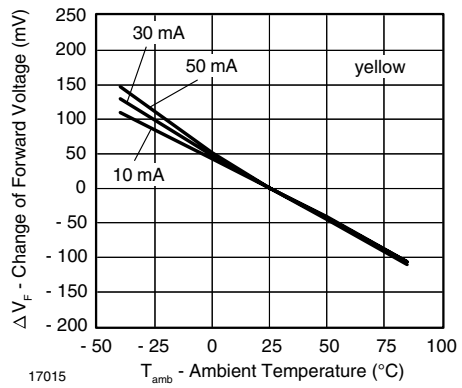
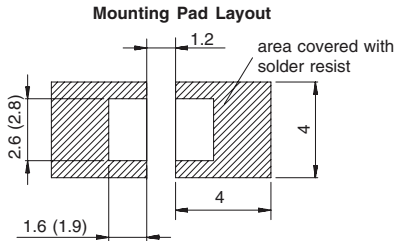

Figure 22. Change of Forward Voltage vs. Ambient Temperature

PACKAGE DIMENSIONS in millimeters



Drawing-No.: 6.541-5067.01-4
 Issue: 2; 27.06.06
 20541_1

METHOD OF TAPING/POLARITY AND TAPE AND REEL

SMD LED (VLM3 - SERIES)

Vishay's LEDs in SMD packages are available in an antistatic 8 mm blister tape (in accordance with DIN IEC 40 (CO) 564) for automatic component insertion. The blister tape is a plastic strip with impressed component cavities, covered by a top tape.

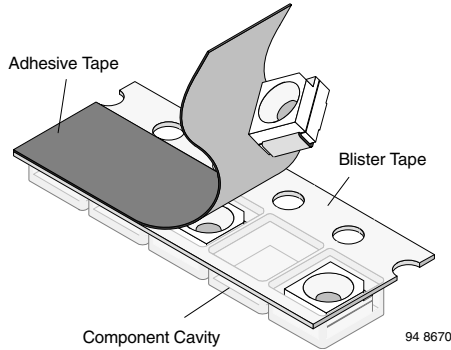

REEL PACKAGE DIMENSION IN MM FOR SMD LEDS, TAPE OPTION GS08 (= 1500 PCS.)

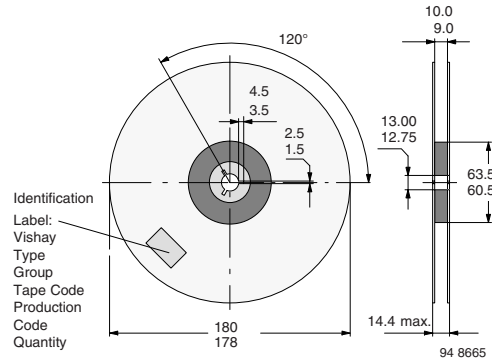

Figure 24. Reel dimensions - GS08

REEL PACKAGE DIMENSION IN MM FOR SMD LEDS, TAPE OPTION GS18 (= 8000 PCS.) PREFERRED

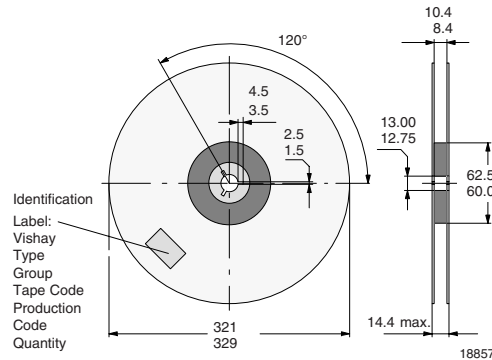

Figure 25. Reel dimensions - GS18

TAPING OF VLM.33..

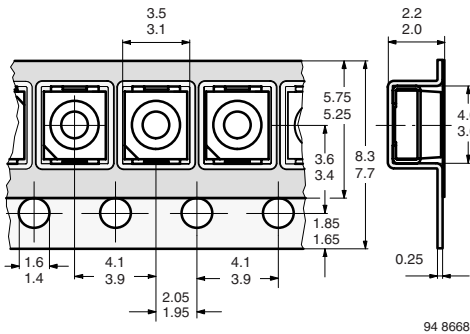

Figure 23. Tape dimensions in mm for PLCC-2

SOLDERING PROFILE



Figure 26. Vishay Lead (Pb)-free Reflow Soldering Profile (acc. to J-STD-020C)

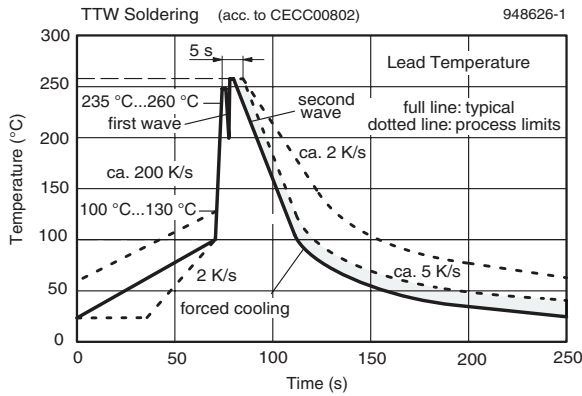

Figure 27. Double wave soldering of opto devices (all packages)

BARCODE-PRODUCT-LABEL EXAMPLE:



- A) Type of component
- B) Manufacturing Plant
- C) SEL - Selection Code (Bin):
e.g.: R2 = Code for Luminous Intensity Group
3 = Code for Color Group
- D) Date Code year/week
- E) Day Code (e.g. 1: Monday)
- F) Batch No.
- G) Total quantity
- H) Company Code

DRY PACKING

The reel is packed in an anti-humidity bag to protect the devices from absorbing moisture during transportation and storage.

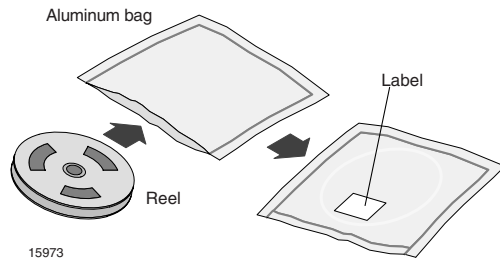

FINAL PACKING

The sealed reel is packed into a cardboard box. A secondary cardboard box is used for shipping purposes.

RECOMMENDED METHOD OF STORAGE

Dry box storage is recommended as soon as the aluminum bag has been opened to prevent moisture absorption. The following conditions should be observed, if dry boxes are not available:

- Storage temperature 10 °C to 30 °C
- Storage humidity $\leq 60\%$ RH max.

After more than 672 hours under these conditions moisture content will be too high for reflow soldering.

In case of moisture absorption, the devices will recover to the former condition by drying under the following condition:

192 hours at 40 °C + 5 °C/- 0 °C and < 5 % RH (dry air/nitrogen) or

96 hours at 60 °C + 5 °C and < 5 % RH for all device containers or

24 hours at 100 °C + 5 °C not suitable for reel or tubes.

An EIA JEDEC Standard JESD22-A112 Level 2a label is included on all dry bags.

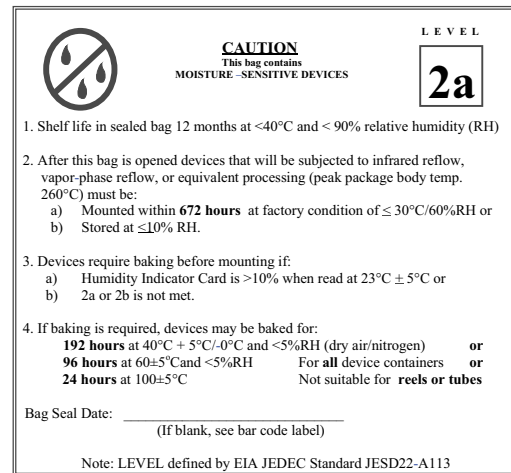

Example of JESD22-A112 Level 2a label

ESD PRECAUTION

Proper storage and handling procedures should be followed to prevent ESD damage to the devices especially when they are removed from the Antistatic Shielding Bag. Electro-Static Sensitive Devices warning labels are on the packaging.

VISHAY SEMICONDUCTORS STANDARD BAR-CODE LABELS

The Vishay Semiconductors standard bar-code labels are printed at final packing areas. The labels are on each packing unit and contain Vishay Semiconductors specific data.

OZONE DEPLETING SUBSTANCES POLICY STATEMENT

It is the policy of Vishay Semiconductor GmbH to

1. Meet all present and future national and international statutory requirements.
2. Regularly and continuously improve the performance of our products, processes, distribution and operating systems with respect to their impact on the health and safety of our employees and the public, as well as their impact on the environment.

It is particular concern to control or eliminate releases of those substances into the atmosphere which are known as ozone depleting substances (ODSs).

The Montreal Protocol (1987) and its London Amendments (1990) intend to severely restrict the use of ODSs and forbid their use within the next ten years. Various national and international initiatives are pressing for an earlier ban on these substances.

Vishay Semiconductor GmbH has been able to use its policy of continuous improvements to eliminate the use of ODSs listed in the following documents.

1. Annex A, B and list of transitional substances of the Montreal Protocol and the London Amendments respectively
2. Class I and II ozone depleting substances in the Clean Air Act Amendments of 1990 by the Environmental Protection Agency (EPA) in the USA
3. Council Decision 88/540/EEC and 91/690/EEC Annex A, B and C (transitional substances) respectively.

Vishay Semiconductor GmbH can certify that our semiconductors are not manufactured with ozone depleting substances and do not contain such substances.

We reserve the right to make changes to improve technical design
and may do so without further notice.

Parameters can vary in different applications. All operating parameters must be validated for each customer application by the customer. Should the buyer use Vishay Semiconductors products for any unintended or unauthorized application, the buyer shall indemnify Vishay Semiconductors against all claims, costs, damages, and expenses, arising out of, directly or indirectly, any claim of personal damage, injury or death associated with such unintended or unauthorized use.

Vishay Semiconductor GmbH, P.O.B. 3535, D-74025 Heilbronn, Germany



Disclaimer

All product specifications and data are subject to change without notice.

Vishay Intertechnology, Inc., its affiliates, agents, and employees, and all persons acting on its or their behalf (collectively, "Vishay"), disclaim any and all liability for any errors, inaccuracies or incompleteness contained herein or in any other disclosure relating to any product.

Vishay disclaims any and all liability arising out of the use or application of any product described herein or of any information provided herein to the maximum extent permitted by law. The product specifications do not expand or otherwise modify Vishay's terms and conditions of purchase, including but not limited to the warranty expressed therein, which apply to these products.

No license, express or implied, by estoppel or otherwise, to any intellectual property rights is granted by this document or by any conduct of Vishay.

The products shown herein are not designed for use in medical, life-saving, or life-sustaining applications unless otherwise expressly indicated. Customers using or selling Vishay products not expressly indicated for use in such applications do so entirely at their own risk and agree to fully indemnify Vishay for any damages arising or resulting from such use or sale. Please contact authorized Vishay personnel to obtain written terms and conditions regarding products designed for such applications.

Product names and markings noted herein may be trademarks of their respective owners.



Компания «ЭлектроПласт» предлагает заключение долгосрочных отношений при поставках импортных электронных компонентов на взаимовыгодных условиях!

Наши преимущества:

- Оперативные поставки широкого спектра электронных компонентов отечественного и импортного производства напрямую от производителей и с крупнейших мировых складов;
- Поставка более 17-ти миллионов наименований электронных компонентов;
- Поставка сложных, дефицитных, либо снятых с производства позиций;
- Оперативные сроки поставки под заказ (от 5 рабочих дней);
- Экспресс доставка в любую точку России;
- Техническая поддержка проекта, помощь в подборе аналогов, поставка прототипов;
- Система менеджмента качества сертифицирована по Международному стандарту ISO 9001;
- Лицензия ФСБ на осуществление работ с использованием сведений, составляющих государственную тайну;
- Поставка специализированных компонентов (Xilinx, Altera, Analog Devices, Intersil, Interpoint, Microsemi, Aeroflex, Peregrine, Syfer, Eurofarad, Texas Instrument, Miteq, Cobham, E2V, MA-COM, Hittite, Mini-Circuits, General Dynamics и др.);

Помимо этого, одним из направлений компании «ЭлектроПласт» является направление «Источники питания». Мы предлагаем Вам помощь Конструкторского отдела:

- Подбор оптимального решения, техническое обоснование при выборе компонента;
- Подбор аналогов;
- Консультации по применению компонента;
- Поставка образцов и прототипов;
- Техническая поддержка проекта;
- Защита от снятия компонента с производства.



Как с нами связаться

Телефон: 8 (812) 309 58 32 (многоканальный)

Факс: 8 (812) 320-02-42

Электронная почта: org@eplast1.ru

Адрес: 198099, г. Санкт-Петербург, ул. Калинина, дом 2, корпус 4, литера А.