

DATA SHEET

SE5005L: 5 GHz Power Amplifier with Power Detector

Applications

- DSSS 5 GHz WLAN (IEEE802.11a)
- Access points
- PCMCIA cards
- PC cards

Features

- 5 GHz matched +18 dBm PA
- Integrated PA enable pin (V_{EN})
- Buffered, temperature-compensated power detector
- High and low linearity modes
- 3% EVM, @ +18 dBm, 64 QAM, 54 Mbps
- +30 dB typical gain
- DC blocked
- QFN (16-pin, 3.0 mm x 3.0 mm x 0.9 mm) package (MSL1 @ 260 °C per JEDEC J-STD-020)



Skyworks Green™ products are compliant with all applicable legislation and are halogen-free. For additional information, refer to *Skyworks Definition of Green™*, document number SQ04-0074.

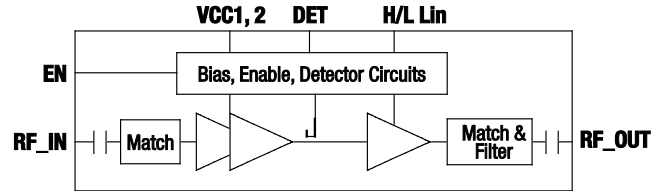

Note: The RF I/Os are DC blocked.

K111

Figure 1. SE5005L Block Diagram

Description

The SE5005L is a 5 GHz Power Amplifier (PA) that offers high linear power for wireless LAN applications.

The SE5005L offers a high level of integration for a simplified design, which provides quicker time-to-market and higher application board production yield. The SE5005L integrates all matching elements, a 3.8 GHz notch filter, and a temperature-compensated, load-insensitive power detector with +20 dB of dynamic range.

For wireless LAN applications, the SE5005L meets the requirements of IEEE 802.11a and delivers approximately +18 dBm of linear output power. The SE5005L also features a linearity mode-control function to reduce current consumption at low power.

The SE5005L integrates the reference voltage generator, which allows for a true Complementary Metal Oxide Semiconductor (CMOS) compatible digital enable (EN) function to turn the PA on and off.

A functional block diagram is shown in Figure 1. The pin configuration and package are shown in Figure 2. Signal pin assignments and functional pin descriptions are provided in Table 1.

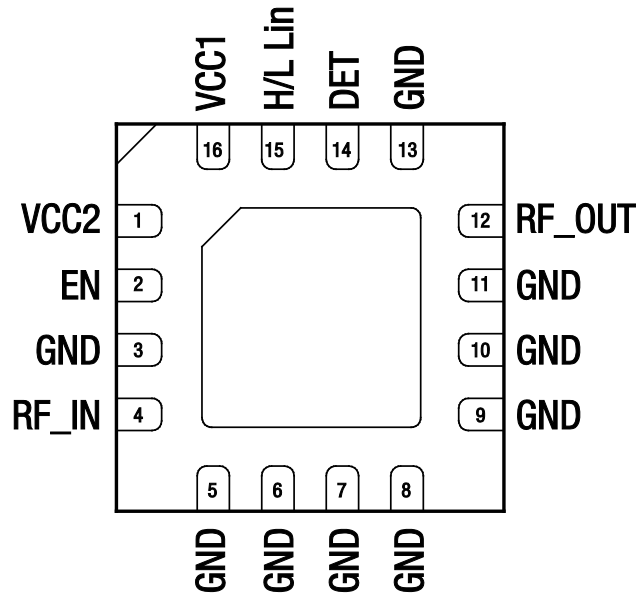

Figure 2. SE5005L Pinout (Top View)

Table 1. SE5005L Signal Descriptions

Pin #	Name	Description	Pin #	Name	Description
1	VCC2	Bias and driver supply voltage	9	GND	Ground
2	EN	PA enable	10	GND	Ground
3	GND	Ground	11	GND	Ground
4	RFIN	TX RF input signal	12	RFOUT	5 GHz antenna output
5	GND	Ground	13	GND	Ground
6	GND	Ground	14	DET	Power detector output
7	GND	Ground	15	H/L Lin	High to low linearity control
8	GND	Ground	16	VCC1	Power stage supply voltage

Table 2. SE5005L Absolute Maximum Ratings

Parameter	Symbol	Minimum	Maximum	Units
Supply voltage on VCC1 and VCC2 pins	V _{CC}	-0.3	4.2	V
DC input on Enable	EN	-0.3	3.6	V
RF input power, RF_OUT into 50 Ω match	RFIN		+12	dBm
Storage temperature range	T _{STG}	-40	150	°C
Electrostatic discharge—Human Body Model (HBM), JEDEC JESD22-A114 all pins	ESD _{HBM}		350	V

Note: Exposure to maximum rating conditions for extended periods may reduce device reliability. There is no damage to device with only one parameter set at the limit and all other parameters set at or below their nominal value. Exceeding any of the limits listed here may result in permanent damage to the device.

CAUTION: Although this device is designed to be as robust as possible, Electrostatic Discharge (ESD) can damage this device. This device must be protected at all times from ESD. Static charges may easily produce potentials of several kilovolts on the human body or equipment, which can discharge without detection. Industry-standard ESD precautions should be used at all times.

Table 3. Recommended Operating Conditions

Parameter	Symbol	Minimum	Maximum	Units
Supply voltage on VCC1 and VCC2 pins	V _{CC}	3.0	3.6	V
Ambient Temperature	T _A	-40	85	°C

Electrical and Mechanical Specifications

The absolute maximum ratings of the SE5005L are provided in Table 2. The recommended operating conditions are specified in Table 3, and electrical specifications are provided in Tables 4 and 5.

The state of the SE5005L is determined by the logic provided in Table 6.

DATA SHEET • SE5005L: 5 GHz POWER AMPLIFIER WITH POWER DETECTOR

Table 4. SE5005L Electrical Specifications: Transmit (Tx) AC Characteristics (Note 1)
(V_{CC} = V_{EN} = C₀ = H/L Lin = 3.3 V, T_A = +25 °C, as Measured on Skyworks SE5005L-EK1 Evaluation Board, Unless Otherwise Noted)

Parameter	Symbol	Test Condition	Min.	Typ.	Max.	Units
Frequency range	f		5.15		5.75	GHz
Output power, 802.11a, 64 QAM: High linearity mode H/L Lin = 3.3 V Low linearity mode H/L Lin = 0 V	P _{OUT}	EVM = 3% EVM < 2.2% MCS0, HT20, mask compliant MCS0, HT40, mask compliant EVM = 3% EVM < 2.2% MCS0, HT20, mask compliant MCS0, HT40, mask compliant		+18 +16 +22 +21 +17 +15 +20 +19		dBm 0
Output 1dB compression point	P1dB	No modulation		+27 +23		dBm
Input return loss	S ₁₁	P _{IN} = -25 dBm	+22	+25		dBm
Gain: Small signal Small signal variation Out of band	S ₂₁ ΔS ₂₁ S _{21_3.8}	P _{IN} = -25dBm High linearity mode Low linearity mode Gain variation over single 40 MHz channel Gain variation over band Gain at 3.8 GHz	+10 +27 +23 -1.5	+14	+34 +32 +0.5 +1.5 +10	dB
Harmonic	2f 3f	P _{OUT} = +18 dBm, OFDM		-50 -60	-42 -42	dBm/MHz
Rise and fall time	t _r , t _f			0.5		μs
Stability	STAB	P _{OUT} = +18 dBm, 54 Mbps, 64 QAM, VSWR = 6:1, all phases	All non-harmonically related outputs less than -50 dBc/100 kHz			
Ruggedness—tolerance to output load mismatching	RU	P _{IN} = +12 dBm, CW, VSWR = 6:1, all phases	No damage			
Robustness tolerance to input power		P _{IN} = +12 dBm, CW, VSWR = 6:1, all phases	No damage			

Note 1: Performance is guaranteed only under the conditions listed in the above Table.

Table 5. SE5005L Power Detector Characteristics (Note 1)
(V_{CC} = V_{EN} = 3.3 V, f = 5.4 GHz, T_A = +25 °C, as Measured on Skyworks SE2432L-EK1 Evaluation Board, Unless Otherwise Noted)

Parameter	Symbol	Test Condition	Minimum	Typical	Maximum	Units
P _{OUT} detect range	PDR		0		P1dB	dBm
Detector voltage	VDET ₂₂ VDET ₁₆ VDET ₂	P _{OUT} = +22 dBm P _{OUT} = +16 dBm P _{OUT} = +2 dBm	0.80 0.55 0.25		1.0 0.60 0.35	V
Output impedance	PDZ _{OUT}			5		kΩ

Note 1: Performance is guaranteed only under the conditions listed in the above Table.

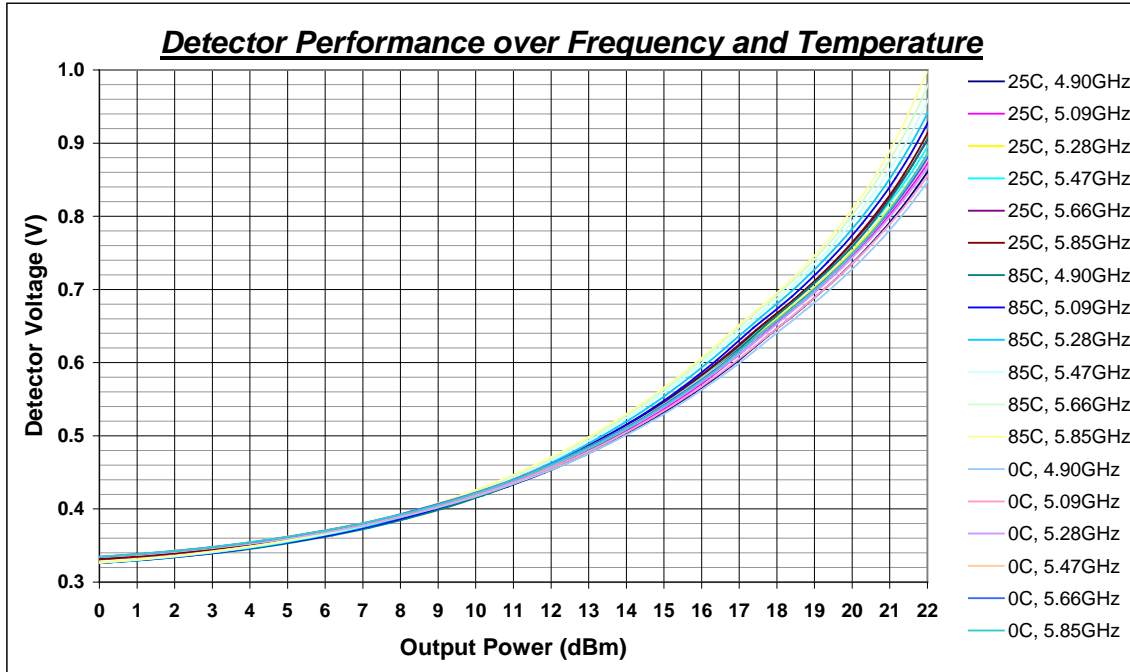

Figure 3. SE5005L Power Detector Sweep over Temperature and Frequency

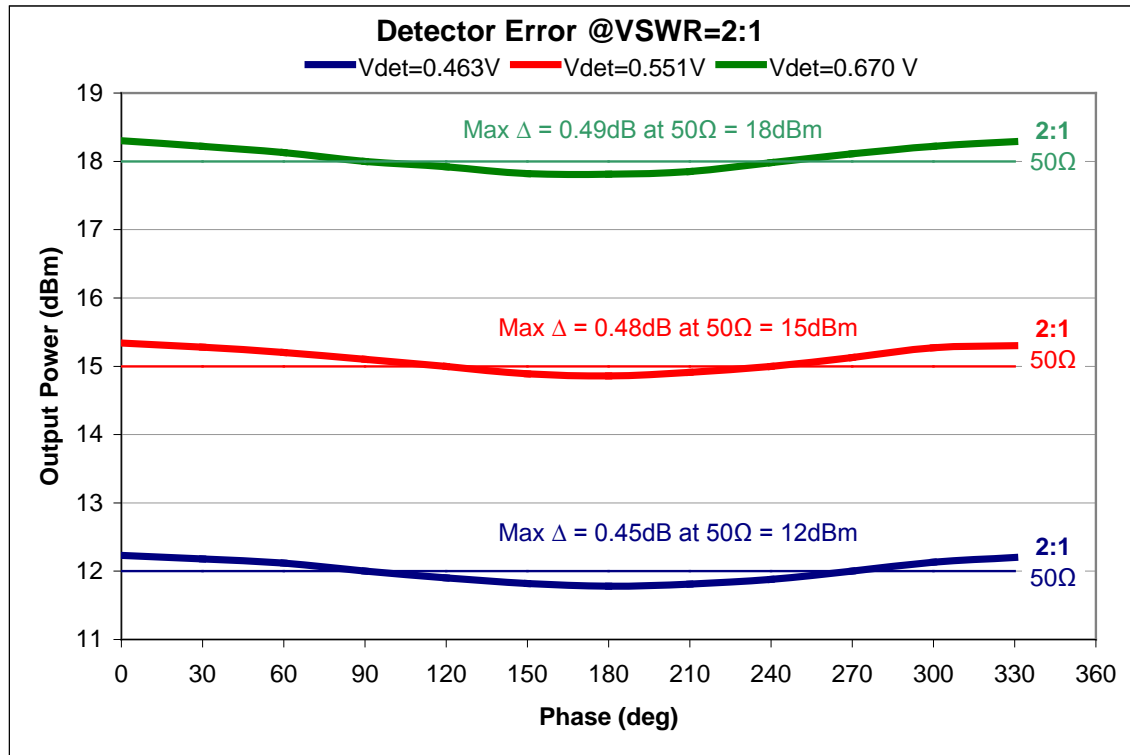

Figure 4. SE5005L Power Detector Accuracy at 2:1 Mismatch

Table 6. SE5005L Logic Control Characteristics

(V_{CC} = V_{EN} = 3.3 V, T_A = +25 °C, as Measured on Skyworks SE5005L-EV1 Evaluation Board, Unless Otherwise Noted)

Parameter	Symbol	Test Condition	Minimum	Typical	Maximum	Units
Supply current	ICC-802.11a	P _{OUT} = +18 dBm, 54 Mbps, 64 QAM, H/L Lin = 3.3V (high linearity mode) P _{OUT} = +14 dBm, 54 Mbps, 64 QAM, H/L Lin = 0V (low linearity mode) P _{OUT} = +5 dBm, 54 Mbps, 64 QAM, H/L Lin = 0V (low linearity mode)		195 140 108		mA mA mA
	I _{OFF}	V _{EN} = 0 V, No RF		0.5		μA
Logic voltage:						
	High	V _{ENH}	+2.8		+3.6	V
Low	V _{ENL}		-0.3		+0.3	V
Input current logic voltage:						
	High	I _{ENH}			400	μA
Low	I _{ENL}			<1		μA

Package Dimensions

Branding information is shown in Figure 5. Package dimensions are shown in Figure 6, the recommended land and solder pattern is shown in Figure 7, and tape and reel dimensions are provided in Figure 5.

The SE5005L is rated to Moisture Sensitivity Level 1 (MSL1) at 260 °C, and can be used for lead or lead-free soldering. For additional information, refer to the Skyworks Application Note, *Solder Reflow Information* (Document Number 200164).

Package and Handling Information

Instructions on the shipping container label regarding exposure to moisture after the container seal is broken must be followed. Otherwise, problems related to moisture absorption may occur when the part is subjected to high temperatures during solder assembly.

Care must be taken when attaching this product, whether it is done manually or in a production solder reflow environment. Production quantities of this product are shipped in a standard tape and reel format.

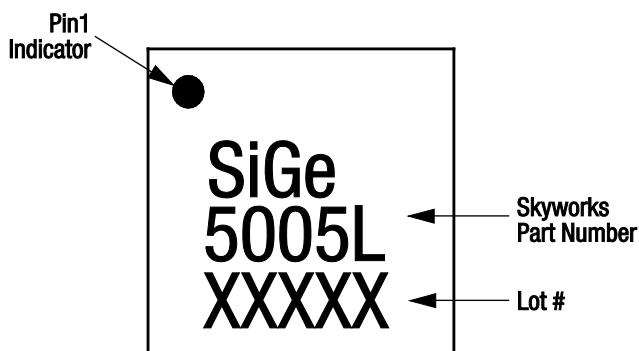
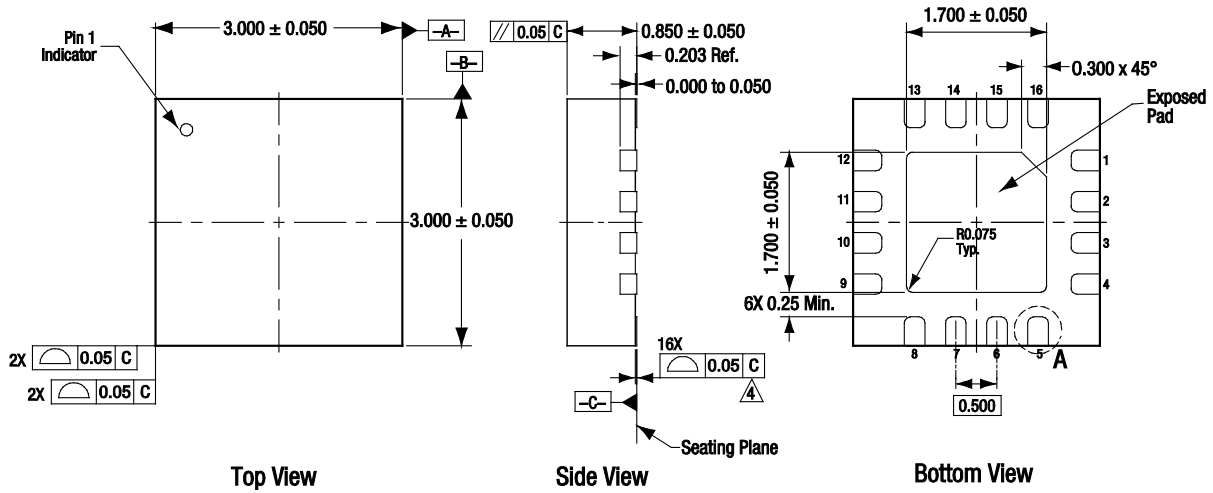
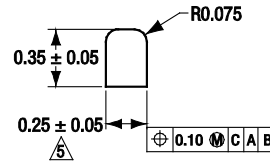

Figure 5. SE5005L Typical Part Marking (Top View)



1. All measurements are in millimeters.
2. Dimensioning and tolerancing according to ASME Y14.5M-1994.
Unless otherwise specified the following values apply:
Decimal Tolerance: Angular Tolerance:
X.X (1 place) ± 0.1 mm ±0.5°
X.XX (2 places) ± 0.05 mm
X.XXX (3 places) ± 0.025 mm
3. Coplanarity applies to the exposed heat sink slug as well as the terminals.
4. Dimension applies to metalized terminal. If terminal has a radius, dimension should be measured in that radius area.
5. Unless specified, dimensions are symmetrical about center lines.



Detail A
Scale 2X
16 Places

S3396

Figure 6. SE5005L Package Dimensions

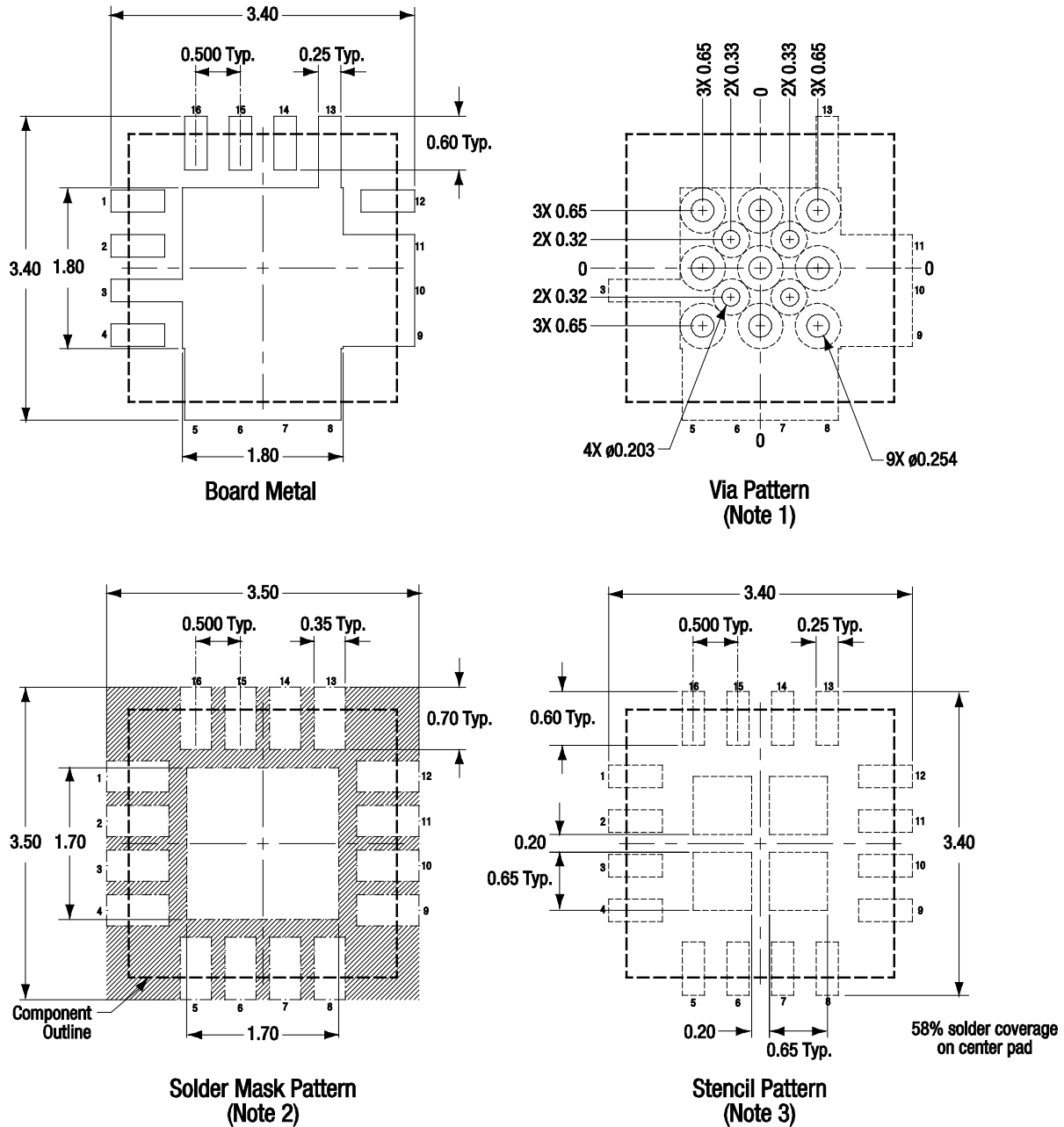

NOTES:

1. **Via hole recommendations:**
0.025 mm Cu via wall plating (minimum), soldermask on the farside should tent or plug via holes.
2. **Soldermask recommendations:**
Contact board fabricator for recommended soldermask offset and tolerance.
3. **Stencil recommendations:**
0.125 mm stencil thickness, laser cut apertures, trapezoidal walls, and rounded corners offer better paste release.

Dimension and tolerancing according to ASME Y14.5M-1994. Unless specified, dimensions are symmetrical about center lines. All dimensions are in millimeters.

S3397

Figure 7. SE5005L Recommended Land and Solder Pattern

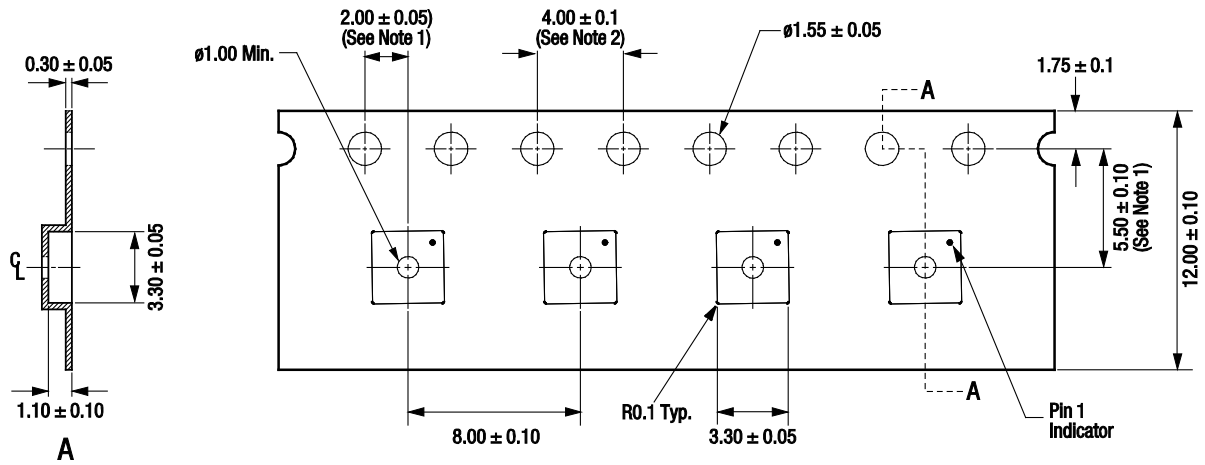

Notes:

1. Measured from centerline of sprocket hole to centerline of pocket.
2. Cumulative tolerance of 10 sprocket holes: ± 0.02 mm.
3. All measurements are in millimeters.

S3377

Figure 8. SE5005L Tape and Reel Information

Ordering Information

Model Name	Manufacturing Part Number	Evaluation Board Part Number
SE5005L: 5 GHz Power Amplifier with Power Detector	SE5005L	SE5005L-EK1

Copyright © 2012, 2013 Skyworks Solutions, Inc. All Rights Reserved.

Information in this document is provided in connection with Skyworks Solutions, Inc. (“Skyworks”) products or services. These materials, including the information contained herein, are provided by Skyworks as a service to its customers and may be used for informational purposes only by the customer. Skyworks assumes no responsibility for errors or omissions in these materials or the information contained herein. Skyworks may change its documentation, products, services, specifications or product descriptions at any time, without notice. Skyworks makes no commitment to update the materials or information and shall have no responsibility whatsoever for conflicts, incompatibilities, or other difficulties arising from any future changes.

No license, whether express, implied, by estoppel or otherwise, is granted to any intellectual property rights by this document. Skyworks assumes no liability for any materials, products or information provided hereunder, including the sale, distribution, reproduction or use of Skyworks products, information or materials, except as may be provided in Skyworks Terms and Conditions of Sale.

THE MATERIALS, PRODUCTS AND INFORMATION ARE PROVIDED “AS IS” WITHOUT WARRANTY OF ANY KIND, WHETHER EXPRESS, IMPLIED, STATUTORY, OR OTHERWISE, INCLUDING FITNESS FOR A PARTICULAR PURPOSE OR USE, MERCHANTABILITY, PERFORMANCE, QUALITY OR NON-INFRINGEMENT OF ANY INTELLECTUAL PROPERTY RIGHT; ALL SUCH WARRANTIES ARE HEREBY EXPRESSLY DISCLAIMED. SKYWORKS DOES NOT WARRANT THE ACCURACY OR COMPLETENESS OF THE INFORMATION, TEXT, GRAPHICS OR OTHER ITEMS CONTAINED WITHIN THESE MATERIALS. SKYWORKS SHALL NOT BE LIABLE FOR ANY DAMAGES, INCLUDING BUT NOT LIMITED TO ANY SPECIAL, INDIRECT, INCIDENTAL, STATUTORY, OR CONSEQUENTIAL DAMAGES, INCLUDING WITHOUT LIMITATION, LOST REVENUES OR LOST PROFITS THAT MAY RESULT FROM THE USE OF THE MATERIALS OR INFORMATION, WHETHER OR NOT THE RECIPIENT OF MATERIALS HAS BEEN ADVISED OF THE POSSIBILITY OF SUCH DAMAGE.

Skyworks products are not intended for use in medical, lifesaving or life-sustaining applications, or other equipment in which the failure of the Skyworks products could lead to personal injury, death, physical or environmental damage. Skyworks customers using or selling Skyworks products for use in such applications do so at their own risk and agree to fully indemnify Skyworks for any damages resulting from such improper use or sale.

Customers are responsible for their products and applications using Skyworks products, which may deviate from published specifications as a result of design defects, errors, or operation of products outside of published parameters or design specifications. Customers should include design and operating safeguards to minimize these and other risks. Skyworks assumes no liability for applications assistance, customer product design, or damage to any equipment resulting from the use of Skyworks products outside of stated published specifications or parameters.

Skyworks, the Skyworks symbol, and “Breakthrough Simplicity” are trademarks or registered trademarks of Skyworks Solutions, Inc., in the United States and other countries. Third-party brands and names are for identification purposes only, and are the property of their respective owners. Additional information, including relevant terms and conditions, posted at www.skyworksinc.com, are incorporated by reference.



Компания «ЭлектроПласт» предлагает заключение долгосрочных отношений при поставках импортных электронных компонентов на взаимовыгодных условиях!

Наши преимущества:

- Оперативные поставки широкого спектра электронных компонентов отечественного и импортного производства напрямую от производителей и с крупнейших мировых складов;
- Поставка более 17-ти миллионов наименований электронных компонентов;
- Поставка сложных, дефицитных, либо снятых с производства позиций;
- Оперативные сроки поставки под заказ (от 5 рабочих дней);
- Экспресс доставка в любую точку России;
- Техническая поддержка проекта, помощь в подборе аналогов, поставка прототипов;
- Система менеджмента качества сертифицирована по Международному стандарту ISO 9001;
- Лицензия ФСБ на осуществление работ с использованием сведений, составляющих государственную тайну;
- Поставка специализированных компонентов (Xilinx, Altera, Analog Devices, Intersil, Interpoint, Microsemi, Aeroflex, Peregrine, Syfer, Eurofarad, Texas Instrument, Miteq, Cobham, E2V, MA-COM, Hittite, Mini-Circuits, General Dynamics и др.);

Помимо этого, одним из направлений компании «ЭлектроПласт» является направление «Источники питания». Мы предлагаем Вам помощь Конструкторского отдела:

- Подбор оптимального решения, техническое обоснование при выборе компонента;
- Подбор аналогов;
- Консультации по применению компонента;
- Поставка образцов и прототипов;
- Техническая поддержка проекта;
- Защита от снятия компонента с производства.



Как с нами связаться

Телефон: 8 (812) 309 58 32 (многоканальный)

Факс: 8 (812) 320-02-42

Электронная почта: org@eplast1.ru

Адрес: 198099, г. Санкт-Петербург, ул. Калинина, дом 2, корпус 4, литера А.