

Features

- RoHS compliant for all six substances
- Extremely wide input voltage ranges up to 154 VDC
- 1 or 2 outputs up to 48 V
- Basic insulation: IMX models
- Class I equipment with reinforced insulation: IMY models
- 1500 to 3000 VAC i/o electric strength test voltage
- Electrical isolation between outputs
- Programmable input undervoltage lockout
- Shutdown/inhibit input
- Adjustable output voltages with flexible load distribution
- Sense lines and current share option
- External frequency synchronization
- Output(s) no-load, overload, and short-circuit proof
- Operating ambient temperature from -40 to 95 °C
- Thermal protection
- Planar technology for best stability
- Metallic case with 12.5 mm profile or open frame with 9.75 mm

Safety-approved to IEC/EN 60950-1 and UL/CSA 60950-1 2nd Edition. CE mark for 110IMY70.

Description

The IMX/IMY70 Series of board-mountable 70 Watt DC-DC converters has been designed according to the latest industry requirements and standards. The converters are particularly suitable for use in mobile or stationary applications in transport, railways, industry, or telecommunication, where variable input voltages or high transient voltages are prevalent.

Covering a total input voltage range from 14.4 V up to 154 V with 3 different models, the converters are available with one or two electrically isolated outputs from 5 V to 48 V, externally adjustable and with flexible load distribution. A shutdown input allows remote converter on/off. Features include consistently high efficiency over the entire input voltage range, high reliability, and excellent dynamic response to load and line changes.

The converters are designed according to the international safety standards IEC/EN/UL 60950-1 2nd Edition. The converters 24IMX70 and 40IMX70 exhibit basic insulation for the



specified input voltage, whereas the converters 110IMY70 have reinforced insulation.

The circuit is comprised of 2 planar magnetic devices. The components are automatically assembled and securely soldered onto a single PCB without any wire connection. Magnetic feedback ensures maximum repeatability in the control loop over all operating conditions and best reliability. Careful consideration of possible thermal stress ensure the absence of hot spots, such providing long life in environments, where temperature cycles are present. The thermal design without using any potting material allows operation up to an ambient temperature of 70 °C in free air and up to 100 °C with forced cooling. For extremely high vibration environments the case has holes for screw mounting.

Table of Contents

	Page		Page
Description	1	Electromagnetic Compatibility (EMC)	11
Model Selection	2	Immunity to Environmental Conditions	12
Functional Description	3	Mechanical Data	13
Electrical Input Data	4	Safety and Installation Instructions	14
Electrical Output Data	6	Options	15
Auxiliary Functions	10		

Copyright © 2015, Bel Power Solutions Inc. All rights reserved.

Model Selection

Table 1: Model Selection

Output 1		Output 2		Input voltage			Effic. η^1		Model	Opt.
$V_{o\text{nom}}$ [V]	$I_{o\text{nom}}$ [A]	$V_{o\text{nom}}$ [V]	$I_{o\text{nom}}$ [A]	$V_{i\text{min}}^2$ [V]	$V_{i\text{cont}}$ [V]	$V_{i\text{max}}^2$ [V]	min. [%]	typ. [%]		
5.1	12	-	-	12	15 to 33.6	40.1			24IMX70-05-0TG ³	i, Z
5.1	12	-	-	21.6	25 to 72	75			40IMX70-05-0TG ³	
5.1	12	-	-	43.2	50 to 137.5	154	89.5	91	110IMY70-05-0TG	
12	7.0	-	-	12	15 to 33.6	40.1	91	93	24IMX70-12-0TG	i, Z
12	7.5	-	-	21.6	25 to 72	75			40IMX70-12-0TG ³	
12	7.5	-	-	43.2	50 to 137.5	154	90	93	110IMY70-12-0TG	
15	5.7	-	-	12	15 to 33.6	40.1	91	92	24IMX70-15-0TG	i, Z
15	6.0	-	-	21.6	25 to 72	75			40IMX70-15-0TG ³	
15	6.0	-	-	43.2	50 to 137.5	154	90	93	110IMY70-15-0TG	
24	1.3	24	1.3	12	15 to 33.6	40.1	87	90	24IMX70-24-24-0G	i, Z
24	1.3	24	1.3	21.6	25 to 72	75			40IMX70-24-24-0G ³	
24	1.3	24	1.3	43.2	50 to 137.5	154	89	91	110IMY70-24-24-0G	

¹ Efficiency at $T_A = 25^\circ\text{C}$, $V_{i\text{nom}}$, $I_{o\text{nom}}$

² Short time; see table 2 for details

³ Contact the Company for lead times and availability.

Note: The sequence of options/features must follow the order above.

Part Number Description

Input voltage V_i	110 IMY70 - 24 - 24 - 0 i Z G
24 V battery 24	
36 V and 48 V battery 40	
72 V, 96 V, 110 V battery 110	
Series IMX70, IMY70	
Output voltage of output 1 05, 12, 15, 24	
Output voltage of output 2 05, 12, 15, 24	
Operating ambient temperature range	
$T_A = -40$ to 95°C -0	
Options:	
Inhibit i	
Current sharing function T ¹	
Open frame Z	
Feature: RoHS-compliant for all 6 substances G ²	

¹ Standard feature for single-output models, not available for dual-output models

² G is standard and is placed at the end of the part number

Note: The sequence of options/features must follow the order above.

Product Marking

Converters without option Z are marked with the type designation, input and output voltages and currents, applicable safety approval and recognition marks, company logo, date code, and serial no.

Functional Description

The IMX/IMY70 Series converters are comprised of a feedback-controlled forward converter using current-mode pulse width modulation (PWM). The switching frequency is fixed; it can be externally synchronized for double-output models. The main transformer and the output choke are designed in planar technology, which guarantees excellent mechanical features and reproducibility of electric properties. No optocouplers are used.

Single-output converters exhibit at the output a synchronous rectifier and sense lines to ensure accurate output voltage regulation. An auxiliary input R allows adjustment of the output voltage. Proper parallel operation is possible using the current sharing feature.

Double-output converters exhibit Schottky diodes at both outputs. The first output voltage is sensed and accurately regulated by influencing the PWM via the magnetic feedback.

The output voltage is transferred to the primary side by magnetic feedback via a pulse transformer. The 2nd output is tracking. The close magnetic coupling of the main transformer and the main choke guarantee minor deviation of both output voltages. Both outputs can be simultaneously adjusted by the R input located on the secondary side.

A current limitation circuit limits the possible output power. The topology allows for single-output models an unlimited output capacity and for double-output models a high output capacity; see *Electrical Output Data*.

An incorporated protection disables the converter in an overtemperature condition. The converter automatically recovers, after the temperature has dropped below the limit.

The input voltage is monitored, shutting down the converter in an overvoltage condition. The minimum input voltage for start-up can be externally adjusted, which helps to limit the input current at low input voltage.

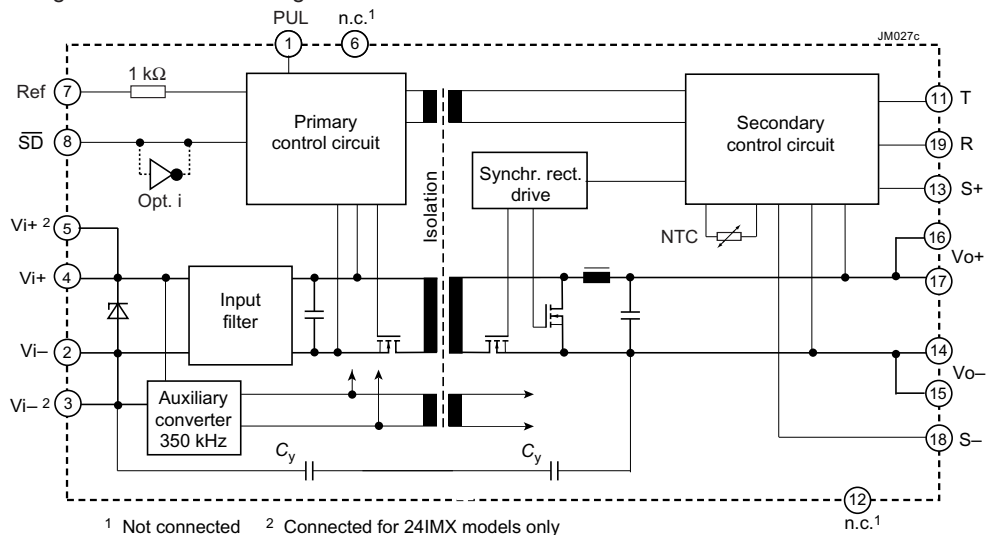

Fig. 1

Block diagram of single-output models

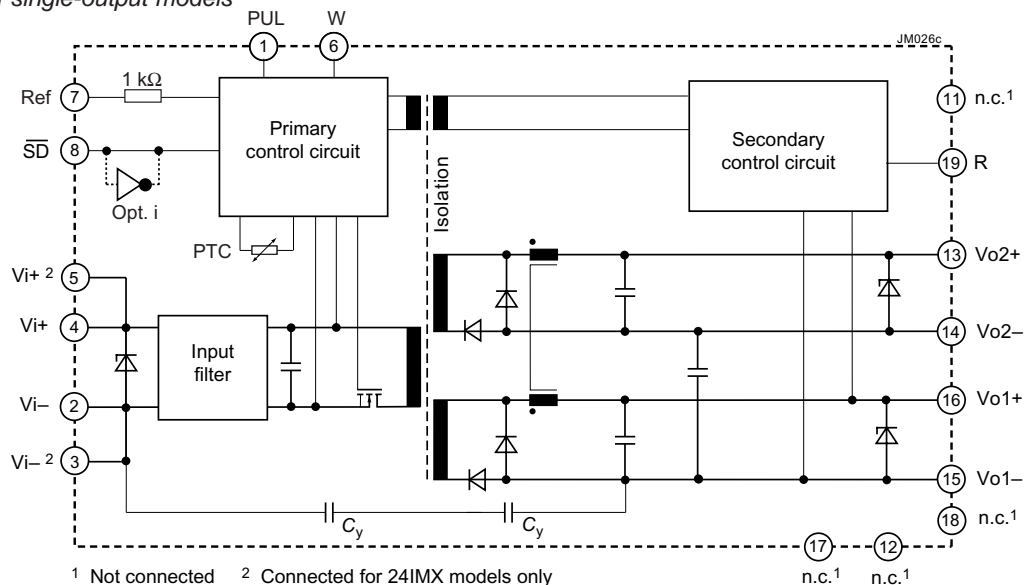

Fig. 2

Block diagram of double-output models

Electrical Input Data

General conditions:

$T_A = 25^\circ\text{C}$, shutdown and R pin left open-circuit, unless specified.

Table 2: Input data

Input			24IMX70			40IMX70			Unit
Characteristics		Conditions	min	typ	max	min	typ	max	
V_i	Operating input voltage	$T_{A \min}$ to $T_{A \max}$, $I_o = 0 - I_{o \text{ nom}}$	15 ¹		33.6	25 ¹		72	VDC
$V_{i \text{ nom}}$	Nominal input voltage			24			(36) 48		
$V_{i \text{ 2s}}$	Temporary input voltage	for 2 s, no shutdown	12 ¹		40.1	21.6 ¹		75	
$V_{i \text{ sur}}$	Repetitive surge voltage	shutdown, no damage			50			100	
$t_{\text{start up}}$	Converter start-up time	Switch on	Worst case condition at $V_{i \text{ min}}$ and full load			500			ms
		$\overline{\text{SD}}$ high							
t_{rise}	Rise time	$V_i = 0 \rightarrow V_{i \text{ nom}}$, $I_o \text{ nom}$	25						
$I_{i \text{ o}}$	No-load input current	$I_o = 0$, $V_{i \text{ min}} - V_{i \text{ max}}$	200						mA
I_{irr}	Reflected ripple current	$I_o = 0 - I_{o \text{ nom}}$	30						mA _{pp}
$I_{\text{inr p}}$	Inrush peak current	$V_i = V_{i \text{ max}}$	25						A
C_i	Input capacitance	for surge calculation	24						μF
$V_{\overline{\text{SD}}}$	Shutdown voltage	Converter disabled	-0.7 to +0.7			-0.7 to +0.7			V
		Converter operating	2 to 20 (or open-circuit)			2 to 20 (or open-circuit)			
$I_{\overline{\text{SD}}}$	Shutdown pin current		-0.2						mA
$I_{i \overline{\text{SD}}}$	Input current at shutdown	$V_{i \text{ min}} - V_{i \text{ max}}$	2						
f_s	Switching frequency	$V_{i \text{ min}} - V_{i \text{ max}}$, $I_o = 0 - I_{o \text{ nom}}$	200 ²	210 ²		200			kHz

Input			110IMY70			Unit
Characteristics		Conditions	min	typ	max	
V_i	Operating input voltage	$T_{A \min}$ to $T_{A \max}$, $I_o = 0 - I_{o \text{ nom}}$	50		137.5	VDC
$V_{i \text{ nom}}$	Nominal input voltage			(72, 96,) 110		
$V_{i \text{ 2s}}$	Temporary input voltage	for 2 s, no shutdown	43.2 ¹		154	
$V_{i \text{ sur}}$	Repetitive surge voltage	shutdown, no damage			168	
$t_{\text{start up}}$	Converter start-up time	Switch on	Worst case condition at $V_{i \text{ min}}$ and full load			ms
		$\overline{\text{SD}}$ high				
t_{rise}	Rise time	$V_i = 0 \rightarrow V_{i \text{ nom}}$, $I_o \text{ nom}$	25			
$I_{i \text{ o}}$	No-load input current	$I_o = 0$, $V_{i \text{ min}} - V_{i \text{ max}}$	25 50			mA
I_{irr}	Reflected ripple current	$I_o = 0 - I_{o \text{ nom}}$	200			mA _{pp}
$I_{\text{inr p}}$	Inrush peak current	$V_i = V_{i \text{ max}}$	35			A
C_i	Input capacitance	for surge calculation	7.7			μF
$V_{\overline{\text{SD}}}$	Shutdown voltage	Converter disabled	-0.7 to +0.7			V
		Converter operating	2 to 20 (or open-circuit)			
$I_{\overline{\text{SD}}}$	Shutdown pin current		-0.2			mA
$I_{i \overline{\text{SD}}}$	Input current at shutdown	$V_{i \text{ min}} - V_{i \text{ max}}$	2			
f_s	Switching frequency	$V_{i \text{ min}} - V_{i \text{ max}}$, $I_o = 0 - I_{o \text{ nom}}$	200 ²	210 ²		kHz

¹ $V_{i \text{ min}}$ will not be as stated, if V_o is increased above $V_{o \text{ nom}}$ by use of R-input. If the output voltage is set to a higher value, $V_{i \text{ min}}$ will be proportionately increased.

² typ. 240 kHz for single-output models, typ. 300 kHz for models with 5 V output

Inrush Current

The inrush current has been kept as low as possible by choosing a very small input capacitance. A series resistor may be installed in the input line, in order to further reduce this current.

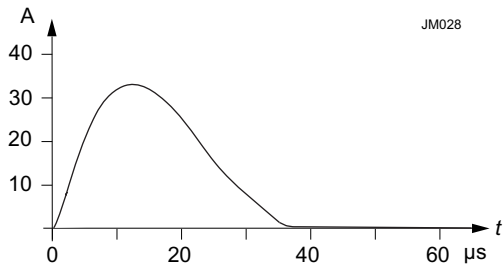

Fig. 3
 Inrush current at $V_{i\text{ nom}}$, $P_{o\text{ nom}}$ versus time (110IMY70-24-24-8). Source impedance according to ETS 300132-2: $L = 10\ \mu\text{H}$, $R = 1.5\ \Omega$.

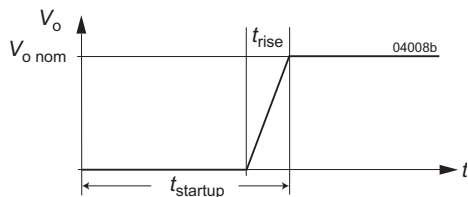

Fig. 4
 Converter start-up and rise time

Reverse Polarity Protection and Fuse

The built-in suppressor diode also provides for reverse polarity protection at the input by conducting current in the reverse direction. An external fuse is required to limit this current.

Table 3: Recommended external fuses in the non-earthed input line

Converter model	Fuse type	Rating
24IMX70 single-output	Littlefuse 166	10 A, 80 V
24IMX70 double-output	Littlefuse 166	10 A, 80 V
40IMX70 single-output		
40IMX70 double-output		
110IMY70 single-output	Littlefuse 372	3.15 A, 250 V
110IMY70 double-output	Littlefuse 372	3.15 A, 250 V

Input Transients Protection

When V_i exceeds 154 V, the converter is temporarily disabled. Furthermore, a built-in suppressor diode provides effective protection against higher input transients, which may be generated for example by short-circuits across the input lines.

Table 4: Built-in transient voltage suppressor

Model	Breakdown voltage $V_{Br\text{ nom}}$ [V]	Peak power at 1 ms P_p [kW]	Peak pulse current I_{pp} [A]
24IMX70	56	1.5	19.4
40IMX70			
110IMY70	176	0.6	2.5

For very high energy transients as for example to achieve IEC/EN 61000-4-5 compliance (as per table *Electromagnetic Immunity*) an external inductor and capacitor are required. The components should have similar characteristics as listed in table below.

Table 5: Components for external circuitry to comply with IEC/EN 61000-4-5; see table 10

Model	Inductor (L)	Capacitor (C)
24IMX70	--	330 μF / 100 V
40IMX70		
110IMY70	--	150 μF / 200 V

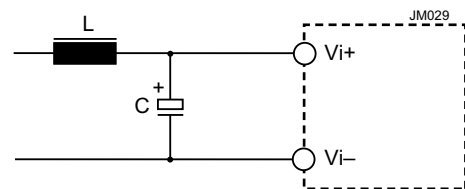

Fig. 5
 Example for external circuitry to comply with IEC/EN 61000-4-5; see table 10

Electrical Output Data

General conditions:

- $T_A = 25\text{ °C}$, unless T_C is specified
- Shutdown pin not connected
- R-pin not connected

Table 6: Output data for single-output models

Output			5.1 V			12 V			Unit
Characteristics		Conditions	min	typ	max	min	typ	max	
V_o	Output voltage	$V_{i\text{ nom}}, 0.5 I_{o\text{ nom}}$	5.07	5.1	5.13	11.94	12.0	12.06	V
$I_{o\text{ nom}}$	Output current	24IMX	$V_{i\text{ min}} - V_{i\text{ max}}$			7.0			A
		40IMX							
		110IMY							
I_{oL}	Current limit ¹	24IMX	$V_{i\text{ nom}}, T_C = 25\text{ °C}$ $V_o = 93\% V_{o\text{ nom}}$			7.5			%
		40IMX							
		110IMY							
ΔV_o	Line/load regulation	$V_{i\text{ min}} - V_{i\text{ max}},$ $(0.1 - 1) I_{o\text{ nom}}$	± 0.5			± 0.5			
$V_{o\text{ noise}}$	Output voltage noise	$V_{i\text{ min}} - V_{i\text{ max}}$ $I_o = I_{o\text{ nom}}$	100			150			mV _{pp}
			50			80			
$V_{o\text{ OS}}$	Output overshoot at turn-on	$V_{i\text{ min}} - V_{i\text{ max}}$	0.1			0.24			V
V_{oL}	Output overvoltage limit	Min. load 1%	6.0	7.0		13.5	15		
$C_{o\text{ ext}}$	Capacitive load		unlimited			unlimited			μF
$V_{o\text{ d}}$	Dynamic load regulation	Voltage deviat.	$V_{i\text{ nom}}$ $(0 \leftrightarrow 0.5) I_{o\text{ nom}}$ or $(0.1 \leftrightarrow 0.6) I_{o\text{ nom}}$			± 1000 ⁴			mV
t_d		Recovery time	2			2			ms
α_{V_o}	Temperature coefficient $\Delta V_o / \Delta T_C$	$V_{i\text{ min}} - V_{i\text{ max}}$ $I_o = (0.1 \text{ to } 1) I_{o\text{ nom}}$	± 0.02			± 0.02			%/K

¹ Rectangular characteristic V_o/I_o

² BW = 20 MHz, measured with an external capacitor of 1 μF across each pair of output pins.

³ Measured with a probe according to EN 61204

⁴ With an output cap $C_o = 2200\text{ }\mu\text{F}$: $\pm 250\text{ mV}$

⁵ With an output cap $C_o = 1500\text{ }\mu\text{F}$: $\pm 600\text{ mV}$

Table 7: Output data for single- and double-output models; general condition as per table 6.

Output			15 V			2 x 24 V			Unit
Characteristics		Conditions	min	typ	max	min	typ	max	
V_o	Output voltage	$V_{i\text{ nom}}, 0.5 I_{o\text{ nom}}$	14.93	15.0	15.08	23.88	24.0	24.12	V
$I_{o\text{ nom}}$	Output current	24IMX	$V_{i\text{ min}} - V_{i\text{ max}}$			2 x 1.3			A
		40IMX							
		110IMY							
I_{oL}	Current limit ¹	24IMX	$V_{i\text{ nom}}, T_C = 25\text{ °C}$ $V_o = 93\% V_{o\text{ nom}}$			3.0 3.15 3.3			
		40IMX							
		110IMY							
ΔV_o	Line/load regulation	$V_{i\text{ min}} - V_{i\text{ max}},$ $(0.1 - 1) I_{o\text{ nom}}$	± 0.5			± 0.5			%
$V_{o\text{ noise}}$	Output voltage noise	$V_{i\text{ min}} - V_{i\text{ max}}$ $I_o = I_{o\text{ nom}}$							
$V_{o\text{ OS}}$	Output overshoot at turn-on	$V_{i\text{ min}} - V_{i\text{ max}}$	0.3			0.48			V
V_{oL}	Output overvoltage limit	Min. load 1%							
$C_{o\text{ ext}}$	Admissible capacitive load		unlimited			0 1500 ^{6,7}			μF
$V_{o\text{ d}}$	Dynamic load regulation	Voltage deviat.							
t_d		Recovery time	2			1			ms
α_{V_o}	Temperature coefficient $\Delta V_o / \Delta T_C$	$V_{i\text{ min}} - V_{i\text{ max}}$ $I_o = (0.1 \text{ to } 1) I_{o\text{ nom}}$							

- The current limit is primary side controlled. In an overload condition the thermal protection may cause the converter to shut down (automatic restart on cool-down).
- BW = 20 MHz, measured with an external capacitor of 1 μF across each output pins.
- Measured with a probe according to EN 61204
- Both outputs of double-output models are protected by a suppressor diode.
- With an output cap $C_o = 1500\text{ }\mu\text{F}$: $\pm 750\text{ mV}$
- Both outputs of double-output models connected in parallel. For series connection, only $1/4$ of the capacitance is possible.
- 1000 μF for 110IMY70-24-24 produced before 2012

Thermal Considerations

Fig. 6a and 6b specify the admissible output power of a converter, mounted on a printed circuit board, located in free environment, exposed to an airflow with the ambient temperature T_A . This applies to continuous operation in the input voltage range $V_{i\text{ min}}$ to $V_{i\text{ max}}$; see table 2, *Input data*. The case temperature T_C (T_{CZ} for option Z) measured at the measuring point of case temperature (see *Mechanical Data*) will approach the indicated value $T_{C\text{ max}}$ after the warm-up phase.

However, the reached temperature T_C depends heavily on the conditions of operation, the distance and temperature of surrounding components, the orientation of the converter and the airflow, and the surfaces, thickness, and properties of the printed circuit board.

Caution: The case temperature T_C (T_{CZ} for option Z), measured at the temperature measuring point (see *Mechanical Data*) may under no circumstances exceed the specified maximum value.

The installer must ensure that under all operating conditions T_C (T_{CZ}) remain within the limits stated in the table *Temperature specifications*.

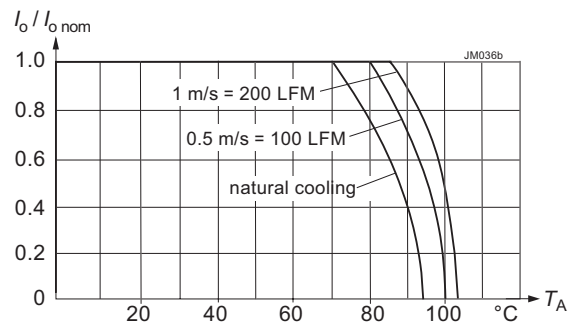

Fig. 6a
 Maximum allowed output power versus ambient temperature for cased models 24IMX70-24-24-0 and 110IMY70-24-24-0 (with rev. AB or greater).

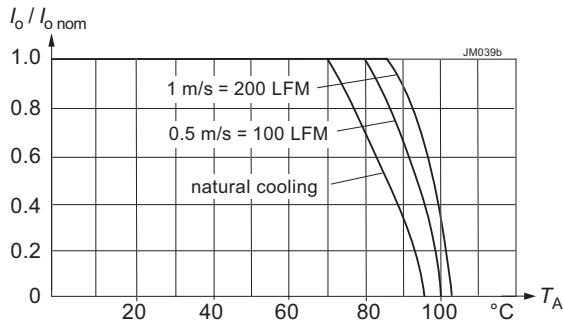

Fig. 6b
Maximum allowed output power versus ambient temperature for 24IMX70-24-24-0Z and 110IMY70-24-24-0Z (with rev. AB or greater).

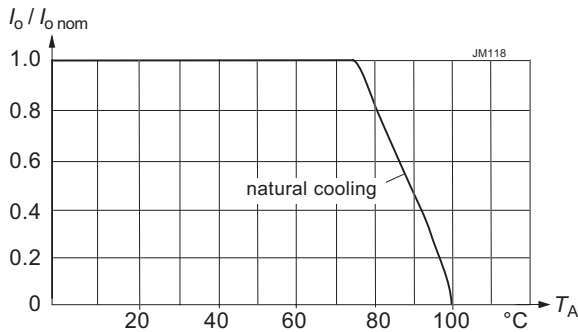

Fig. 6c
Max. allowed output power versus ambient temperature for converters 110IMY70-12 without opt. Z in vertical position.

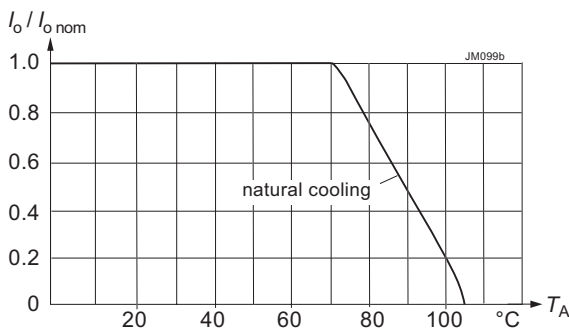

Fig. 6d
Max. allowed output power versus ambient temperature for converters 110IMY70-12-0Z in vertical position.

Overtemperature Protection

The converter is protected against possible overheating by means of an internal temperature monitoring circuit. It shuts down the converter above the internal temperature limit and attempts to automatically restart. This feature prevents excessive internal temperature building up, which could occur under heavy overload conditions.

Short Circuit Behavior

The current limiting circuit decreases the output voltage, when an overcurrent occurs. It protects against a short circuit and automatically recovers after removal of the overload condition. If one output of double-output models is overloaded, the current limiting circuit decreases the output voltage of output 1 and simultaneously of the tracking output 2.

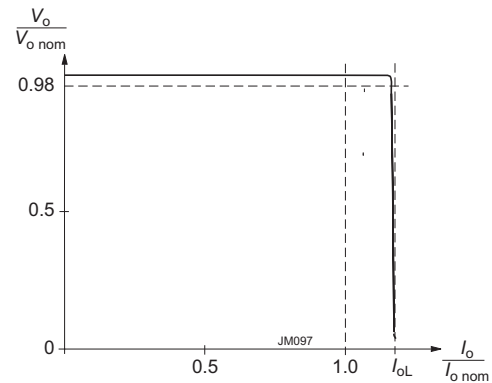

Fig. 7
Rectangular current limitation of single-output models

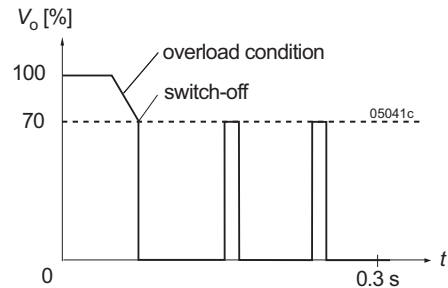

Fig. 8
Current limitation of double-output models with both outputs connected in parallel

Connection in Series

The outputs of all models may be connected in series without any precaution.

Connection in Parallel

If single-output converters are to be operated in parallel, we recommend ordering option T.

Both outputs of a double-output converter can be connected in parallel without precaution and will share their currents evenly.

Note: If output 2 of a double-output converter is not used, connect it parallel to output 1.

Single-output converters without option T or double-output converters with the same nominal output voltage should only be operated in parallel with some precautions. The output lines to the load should have the same length and section. To improve the current repartition, small resistors should be present in the output lines. If ORing diodes are used, double Schottky diodes should be chosen to keep both diodes at the same temperature level. If single diodes are chosen, they should be mounted on the same heat sink. If the total load exceeds 150% of the nominal load of one converter, start-up problems are possible.

Note: Instead of connecting two 24 V models in parallel, we recommend connecting of two 12 V models in series.

Cross Regulation of Double-Output Models

See fig. 9. General conditions:

- $T_A = 25^\circ\text{C}$, unless T_C is specified.
- Shutdown and R pin left open-circuit.

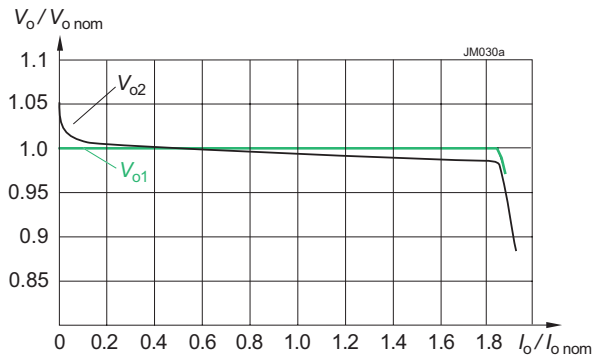

Fig. 9
 Cross regulation of double-output models (typ.)
 V_{o2} versus I_{o2} , $I_{o1} = 0.5 I_{o1\text{ nom}}$

Efficiency

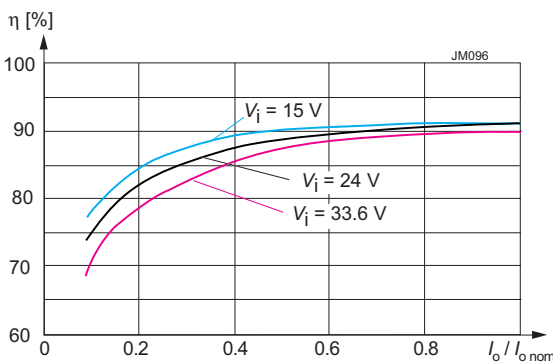

Fig. 10a
 Efficiency versus input voltage and load. Typical values
 (24IMX70-24-24)

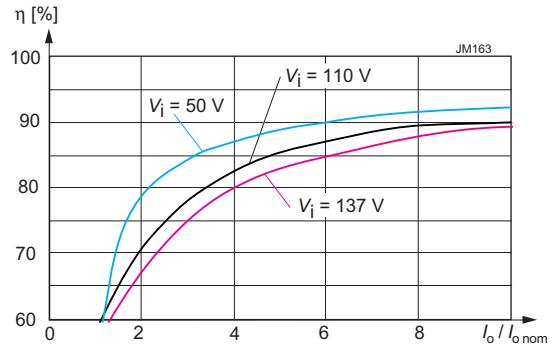

Fig. 10b
 Efficiency versus input voltage and load. Typical values
 (110IMY70-05)

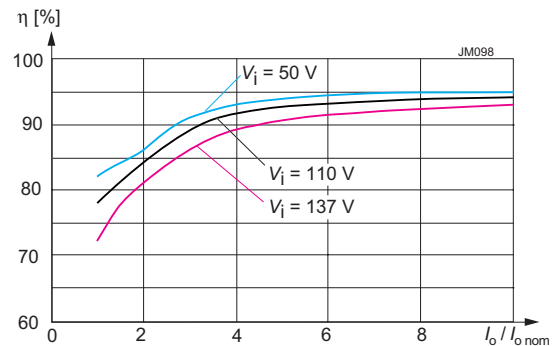

Fig. 10c
 Efficiency versus input voltage and load. Typical values
 (110IMY70-12)

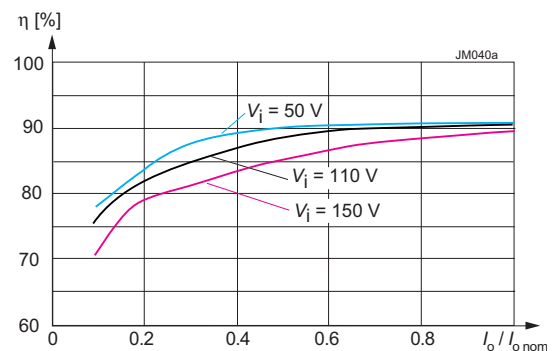

Fig. 10d
 Efficiency versus input voltage and load. Typical values
 (110IMY70-24-24)

Auxiliary Functions

Adjustable Output Voltage

As a standard feature, the converters offer adjustable output voltages by using the control input R. Fig. 10 shows the schematic diagram of the circuitry. If the control input is left open-circuit, the output voltage is set to $V_{o\text{ nom}}$.

Note: For output voltages $V_o > V_{o\text{ nom}}$, the minimum input voltage $V_{i\text{ min}}$ (see *Electr. Input Data*) increases proportionally to $V_o/V_{o\text{ nom}}$.

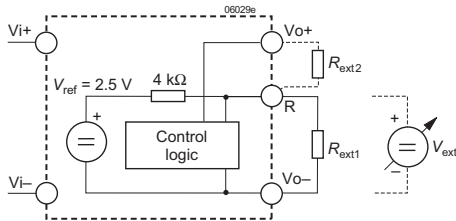

Fig. 11

Output voltage control by means of the R input

The R-input is referenced to the secondary side of the converter. Adjustment of V_o (or V_{o1}) is possible by means of either an external resistor or a voltage source.

- a) Adjustment by means of an external resistor R_{ext} . Depending upon the value of the required output voltage, the resistor shall be connected:
either: Between the R-pin and V_{o-} (or V_{o1}) to achieve an output voltage adjustment range of $V_o \approx 80$ to 100% of $V_{o\text{ nom}}$. Single-output models can be trimmed to $V_o \approx 0$ V.

$$R_{\text{ext1}} \approx 4 \text{ k}\Omega \cdot \frac{V_o}{V_{o\text{ nom}} - V_o}$$

or: Between the R-pin and V_{o+} (or V_{o1+}) to achieve an output voltage range of $V_o \approx 100$ to 105% of $V_{o\text{ nom}}$.

$$R_{\text{ext2}} \approx 4 \text{ k}\Omega \cdot \frac{(V_o - 2.5 \text{ V})}{2.5 \text{ V} \cdot (V_o/V_{o\text{ nom}} - 1)}$$

- b) Adjustment by means of an external voltage V_{ext} between V_{o-} (or V_{o1-}) and the R-pin. The control voltage range is 1.96 to 2.62 V and allows for adjustment in the range of $V_o \approx 80$ to 105% of $V_{o\text{ nom}}$. Single-output models can be trimmed to $V_o \approx 0$ V.

$$V_{\text{ext}} \approx \frac{V_o \cdot 2.5 \text{ V}}{V_{o\text{ nom}}}$$

Note: Single-output models can be trimmed up to 110% of $V_{o\text{ nom}}$.

Note: Applying a higher external control voltage as needed for the max. trim range may damage the converter.

Reference Output (Ref)

The converter provides a stable 5 V (± 0.25 V) reference signal on pin 7 (Ref). The output is protected by a 1 k Ω resistor.

Note: It is recommended to connect a filter capacitor (0.1 μ F) between Ref and V_{i-} , if Ref is used.

Current Sharing (T)

This feature is available for single-output models. Several parallel connected converters will share their current evenly by interconnecting the T pins (pin 11).

Note: This feature allows connecting the outputs together through ORing diodes to achieve redundancy. We recommend Schottky diodes mounted onto the same heat sink (for thermal balancing).

Sense Lines

The sense inputs of single-output models allow for compensating a voltage drop up to 1 V (0.6 V for models with $V_{o\text{ nom}} = 5.1$ V).

Synchronization (W)

Double-output models can be synchronized to an external TTL signal (220 ± 10 kHz, duty cycle 10 – 15%). Due to the higher switching frequency, the efficiency will slightly drop.

Note: If this feature is not used, W (pin 6) can be connected to V_{i-} (pin 2) or left open-circuit.

Shutdown (SD)

The outputs of the converters may be enabled or disabled by a logic signal (TTL, CMOS, etc.) applied between the shutdown pin 8 and V_{i-} . If the shutdown function is not required, pin 8 should be left open-circuit. Voltage on pin 8:

Converter operating:	2.0 to 20 V
Converter disabled:	-0.7 to +0.7 V

Progr. Input Voltage Lockout PUL

A special feature of these converters is the adjustable under-voltage lockout function, protecting the converter (and system) from high currents caused by operation at too low input voltage. This ensures easier start-up in distributed power systems.

The undervoltage lockout level can be programmed by an external resistor R_{PUL} (between PUL and V_{i-}) to increase the preset levels, as indicated in the table below (with hysteresis). The overvoltage lockout (OVL) cannot be varied.

Table 8: Turn-on and shutdown voltage (pin 1 left open)

Model	Turn-on level	Hysteresis	OVL	Unit
24IMX70	13.5 – 14.5	typ. 2.5	41 – 43	V
40IMX70	22 – 23.5			
110IMY70	44.5 – 47.5	typ. 6	160 – 175	

Table 9: Typical values for R_{PUL} and the respective turn-on input voltage $V_{i\text{ LO}}$.

24IMX70 $V_{i\text{ LO}}$ [V]	R_{PUL} [k Ω]		40IMX70 $V_{i\text{ LO}}$ [V]	R_{PUL} [k Ω]	
	single-op.	double-op.		single-op.	double-op.
14	∞	∞	24	∞	∞
16	40.5	120			
18	19.8	62			
20	12.8	41			

110IMY70 $V_{i\text{ LO}}$ [V]	R_{PUL} [k Ω] single-output	R_{PUL} [k Ω] double-output
46	∞	∞
50	68	270
57	25.5	110
61	18	82

Electromagnetic Compatibility (EMC)

A suppressor diode together with an input filter form an effective protection against high input transient voltages which

typically occur in many installations, but especially in battery-driven mobile applications.

Electromagnetic Immunity

Table 10: Immunity type tests

Phenomenon	Standard	Class Level	Coupling mode ¹	Value applied	Waveform	Source imped.	Test procedure	In oper.	Perf- ² crit.		
Electrostatic discharge to case	IEC/EN 61000-4-2 ³		contact discharge (R pin open)	$\pm 6000 V_p$	1/50 ns	330 Ω	10 positive and 10 negative discharges	yes	B		
		3	air discharge (R pin open)	$\pm 8000 V_p$							
Electromagnetic field	IEC/EN 61000-4-3	x ⁴	antenna	20 V/m	80% AM, 1 kHz	n.a.	80 – 1000 MHz	yes	A		
		5	antenna	20 V/m						800 – 1000 MHz	
				10 V/m							1400 – 2100 MHz
				5 V/m							
Electrical fast transients/burst	IEC/EN 61000-4-4: 2004	3 ⁶	direct coupl. (fig. 9)	$\pm 2000 V_p$ ⁶	bursts of 5/50 ns 5 kHz over 15 ms burst period: 300 ms	50 Ω	60 s positive 60 s negative transients per coupling mode	yes	A		
		4	+i/c, -i/c, +i/-i	$\pm 4000 V_p$						yes	B
		3	capacit. (fig. 10), o/c	$\pm 2000 V_p$						yes	B
Surges	IEC/EN 61000-4-5	3 ⁷	+i/c, -i/c	$\pm 2000 V_p$ ³	1.2/50 μ s	12 Ω	5 pos. and 5 neg. surges per coupling mode	yes	B		
		2 ⁷	+i/-i	$\pm 1000 V_p$ ³						2 Ω	
Conducted disturbances	IEC/EN 61000-4-6	3 ⁸	i, o, signal wires	10 VAC (140 dB μ V)	AM 80% 1 kHz	150 Ω	0.15 – 80 MHz	yes	A		

¹ i = input, o = output, c = case (not for option Z)

² A = normal operation, no deviation from specification, B = temporary deviation from specs. possible.

³ Corresponds to EN 50121-3-2:2006, table 9.3

⁴ Corresponds to EN 50121-3-2:2006 table 9.1 and exceeds EN 50121-4:2006 table 1.1.

⁵ Corresponds to EN 50121-3-2:2006 table 9.2 and EN 50121-4:2006 table 1.2 (compliance with digital mobile phones).

⁶ Corresponds to EN 50121-3-2:2006 table 7.2 and EN 50121-4:2006 table 2.2.

⁷ Measured with an external input capacitor specified in table 5

⁸ Corresponds to EN 50121-3-2:2006 table 7.1 and EN 50121-4:2006 table 2.2.

Electromagnetic Emissions

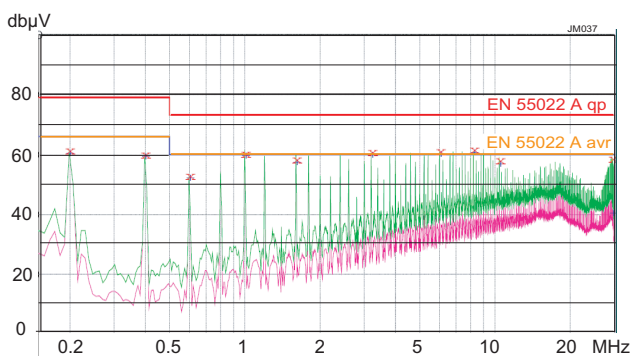

Fig. 12

Typical disturbance voltage at the input (green = peak, x = quasi-peak, pink = average) according to EN 55011/22, measured at $V_{i\text{ nom}}$ and $I_{o\text{ nom}}$. Output leads = 0.1 m, twisted (110IMY70-24-24).

The EMC requirements must be observed at the end product system level. However, we test the converters to EMC standards. An effective integrated input filter significantly reduces the reflected input current and improves EMC features. Further improvements are possible by adding simple external filters.

Immunity to Environmental Conditions

Table 11: Mechanical and climatic stress

Test	method	Standard	Test conditions	Status
Cb	Damp heat steady state	IEC/EN 60068-2-56	Temperature: 25 °C Relative humidity: 95 % Duration: 8 h	Converter operating
Cab	Damp heat steady state	IEC/EN 60068-2-78 MIL-STD-810D section 507.2	Temperature: 40±2 °C Relative humidity: 93 ^{+2/-3} % Duration: 56 days	Converter not operating
Db	Damp heat test, cyclic	EN 50155:2007, clause 12.2.5 IEC/EN 60068-2-30	Temperature: 55 °C and 25 °C Cycles (respiration effect): 2 Duration: 2× 24 h	Converter not operating
Bd	Dry heat test steady state	EN 50155:2007, clause 12.2.4 IEC/EN 60068-2-2	Temperature: 70 °C Duration: 6 h	Converter operating
Ad	Cooling test steady state	EN 50155:2007, clause 12.2.3 IEC/EN 60068-2-1	Temperature, duration Performance test -40 °C, 2 h +25 °C	Conv. not operating
--	Salt mist test sodium chloride (NaCl) solution ²	EN 50155:2007 clause 12.2.10 class ST2 ²	Temperature: 35±2 °C Duration: 16 h	Converter not operating
Fc	Vibration (sinusoidal)	IEC/EN 60068-2-6 MIL-STD-810D section 514.3	Acceleration amplitude: 0.35 mm (10 – 60 Hz) 5 g _n = 49 m/s ² (60 - 2000 Hz) Frequency (1 Oct/min): 10 – 2000 Hz Test duration: 7.5 h (2.5 h in each axis)	Converter operating
Fh	Random vibration broad-band (digital control) and guidance	IEC/EN 60068-2-64	Acceleration spectral density: 0.05 g _n ² /Hz Frequency band: 8 – 500 Hz Acceleration magnitude: 4.9 g _{rms} Test duration: 1.5 h (0.5 h in each axis)	Converter operating
Eb	Bump (half-sinusoidal)	IEC/EN 60068-2-29 MIL-STD-810D section 516.3	Acceleration amplitude: 25 g _n = 245 m/s ² Bump duration: 6 ms Number of bumps: 6000 (1000 in each direction)	Converter operating
Ea	Shock (half-sinusoidal)	IEC/EN 60068-2-27 MIL-STD-810D section 516.3	Acceleration amplitude: 50 g _n = 490 m/s ² Bump duration: 11 ms Number of bumps: 18 (3 in each direction)	Converter operating
--	Shock	EN 50155:2007 clause 12.2.11, EN 61373 sect. 10, class B, body mounted ¹	Acceleration amplitude: 5.1 g _n Bump duration: 30 ms Number of bumps: 18 (3 in each direction)	Converter operating
--	Simulated long life testing at increased random vibration levels	EN 50155:2007 clause 12.2.11, EN 61373 sect. 8 and 9, class B, body mounted ¹	Acceleration spectral density: 0.02 g _n ² / Hz Frequency band: 5 – 150 Hz Acceleration magnitude: 0.8 g _{rms} Test duration: 15 h (5 h in each axis)	Converter operating

¹ Body mounted = chassis of a railway coach

² Models with option Z have been covered by lacquer (Peters SL1301) to simulate the end-use situation.

Temperatures

Table 12: Temperature specifications, valid for air pressure of 800 to 1200 hPa (800 to 1200 mbar)

Temperature		Conditions	-0		Unit
Characteristics			min	max	
T_A	Ambient temperature	In operation ¹	-40	100 ¹	°C
T_C	Case temperature (without opt. Z) ²		-40	105 ²	
T_{CZ}	Component temp. with opt. Z ²		-40	115 ²	
T_S	Storage temperature	Not operational	-55	105	

¹ See *Thermal Considerations*

² Temperature measurement point; see *Mechanical Data*

Reliability

Table 13: Calculated MTBF at nominal load

Model	Ground benign 40 °C	Ground fixed 40 °C		Ground mobile 50 °C	Device hours	Unit
		40 °C	70 °C ¹			
24IMX70-24-24 (Bellcore Telc. SR-332)	1 022 000	510 000	162 500	118 500		h
110IMY70-05 (Bellcore Telc. SR-332)	720 000	360 000	98 000	98 000		
110IMY70-12 (Bellcore Telc. SR-332)	825 000	413 000	182 000	106 000		
110IMY70-24-24 (Bellcore Telc. SR-332)	1 000 000	632 000	163 000	117 400		

¹ with an air flow of 0.5 m/s

Mechanical Data

Dimensions in mm. Tolerances ± 0.3 mm, unless noted.

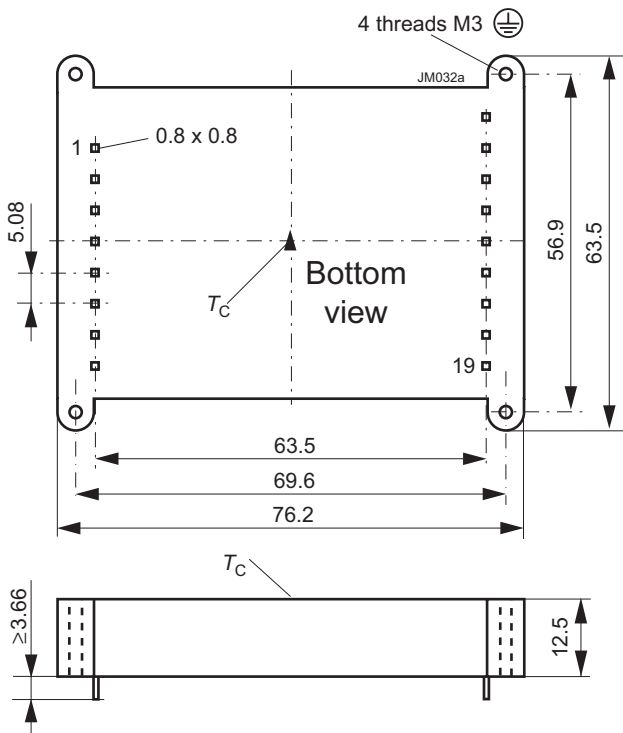

Fig. 13
 Case IMX70/IMY70 (without opt. Z)
 Material Zinc
 Weight: approx. 140 g

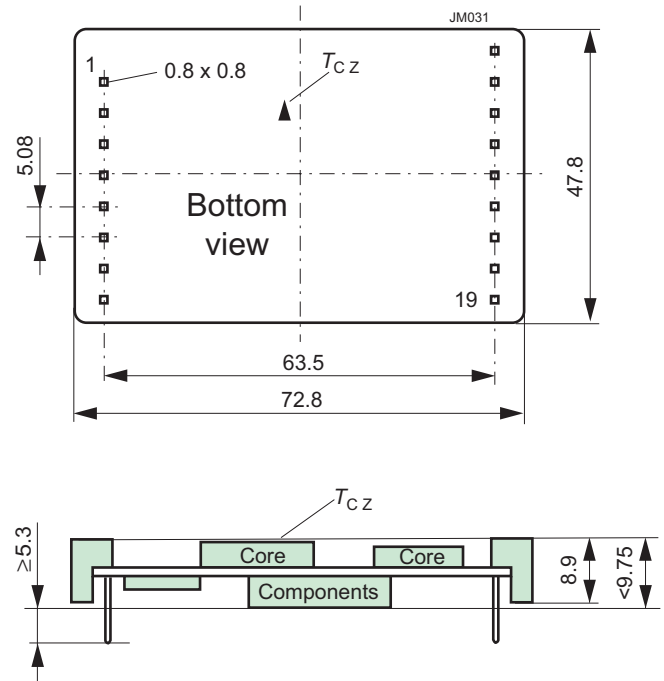

Fig. 14
 IMX70/IMY70 open frame (option Z)
 Weight: approx. 70 g

Safety and Installation Instructions

Pin allocation

Table 14: Pin allocation

Pin no.	Single-output	Double-output
1	PUL	PUL
2	Vi-	Vi-
3	n.c. / Vi- ¹	n.c. / Vi- ¹
4	Vi+	Vi+
5	n.c. / Vi+ ¹	n.c. / Vi+ ¹
6	W (Sync.)	W (Sync.)
7	Ref	Ref
8	\overline{SD} / i^2	\overline{SD} / i^2
11	T	n.c.
12	n.c.	n.c.
13	S+	Vo2+
14	Vo-	Vo2-
15	Vo-	Vo1-
16	Vo+	Vo1+
17	Vo+	n.c.
18	S-	n.c.
19	R (adjust)	R (adjust)

¹ Only connected at 24IMX models, n.c. for 40IMX and 110IMY

² i if option i (inhibit) is fitted

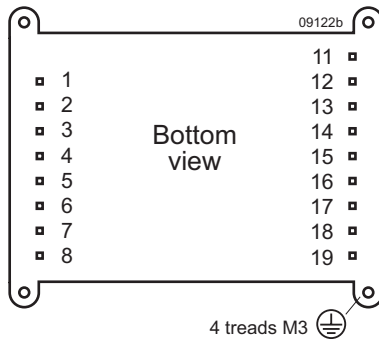

Fig. 15

Footprint. The holes in the PCB should have a diameter of 1.5 mm.

Installation Instructions

Installation of the converters must strictly follow the national safety regulations in compliance with the enclosure, mounting, creepage, clearance, casualty, markings, and segregation requirements of the end-use application.

Connection to the system shall be made via a printed circuit board with hole diameters of 1.5 mm for the pins. Connect both input pins for 24IMX70 models.

The converters should be connected to a secondary circuit.

Ensure that a converter failure (e.g. by an internal short-circuit) does not result in a hazardous condition.

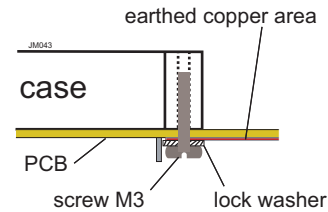

Fig. 16

Reliable connection of the metallic case to protection earth (110IMY70 models). Use at least 2 screws!

Standards and Approvals

The converters are safety agency approved to the standards IEC/EN 60950 and UL/CSA 60950-1 2nd Edition.

The converters have been evaluated for:

- Building-in
- Basic insulation input to output for 24IMX70 and 40IMX70 models, based on the maximum input voltage;
- Reinforced insulation input to output for 110IMY70 models, basic insulation to the case, based on the input voltage of 150 V. The case can be reliably connected to PE (protective earth) – except option Z; see fig. 15.
- Pollution degree 2
- Connecting the input to a secondary circuit, which is subject to a maximum transient rating of 1500 V.

The converters are subject to manufacturing surveillance in accordance with the above mentioned standards.

CB scheme is available.

Input Fuse

To prevent excessive current flowing through the input supply lines in case of a short-circuit in the converter, an external fuse should be installed in the non-earthed input line; see table 3.

Railway Applications

To comply with Railway standards, all components are coated with a protective lacquer (except option Z).

Protection Degree and Cleaning Liquids

The protection degree is IP 40 (except option Z).

In order to avoid possible damage, any penetration of cleaning fluids should be prevented, since the converters are not hermetically sealed.

However, open-frame models (option Z) leave the factory unlacquered; they can be lacquered by the customer, for instance together with the mother board. Cleaning liquids are not permitted – except washing at room temperature with isopropyl alcohol and de-ionized/distilled water (1 : 1).

The mother board can also be cleaned, before fitting the open-frame converter.

Note: Other cleaning liquids can damage the adhesive joints of the ferrite cores.

Isolation

The electric strength test is performed in the factory as a routine test in accordance with EN 50116, IEC/EN 60950-1,

and UL/CSA 60950-1. The Company will not honor any warranty claims resulting from incorrectly executed electric strength field tests.

Table 15: Electric strength test voltages

Characteristic	Input to (outputs+case) 20/40IMX70 ¹	Input to (outputs+case) 110IMY70 ¹	Outputs to case all models ¹	Between outputs all models	Unit
Factory test >1 s	1.5 ²	3	0.5	0.15 ³	kVAC
Equivalent DC voltage	2.1	4.2	0.7	0.21 ³	kVDC
Insulation resistance at 500 VDC	>100	>100	–	–	MΩ

¹ For open-frame models (option Z), only the insulation input to outputs is tested.

² 1.5 kVAC according to IEC 60950, sect. 6.2, Telecom equipment; type test with 1.5 kVAC / 60 s (IEE 802.3).

³ The test voltage between outputs is not applied as routine test.

Options

Option i: Inhibit (Negative Shutdown Logic)

The output of the converter may be enabled or disabled by means of a logic signal (TTL, CMOS, etc.) applied to the inhibit

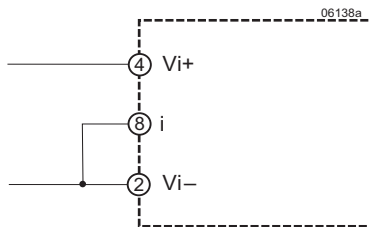

Fig. 17

If the inhibit function is not used, the inhibit pin should be connected to Vi-.

pin 8. No output voltage overshoot will occur, when the converter is turned on. If the inhibit function is not required the inhibit pin 8 should be connected to Vi- to enable the output (active low logic, fail safe). Voltage on pin 8:

Converter operating: –10 V to +0.8 V
 Converter disabled: 2.4 V to 20 V

Option Z

If the converters are mounted onto a mother board, in many cases, a converter case is not required. Only converters with option Z are not varnished, and this allows dipping of the populated board including the converter into a protection lacquer.

Note: The converters shall not be exposed to cleaning processes, as this will damage the glue of the ferrite cores.

NUCLEAR AND MEDICAL APPLICATIONS - Power-One products are not designed, intended for use in, or authorized for use as critical components in life support systems, equipment used in hazardous environments, or nuclear control systems without the express written consent of the respective divisional president of Power-One, Inc.

TECHNICAL REVISIONS - The appearance of products, including safety agency certifications pictured on labels, may change depending on the date manufactured. Specifications are subject to change without notice.



Компания «ЭлектроПласт» предлагает заключение долгосрочных отношений при поставках импортных электронных компонентов на взаимовыгодных условиях!

Наши преимущества:

- Оперативные поставки широкого спектра электронных компонентов отечественного и импортного производства напрямую от производителей и с крупнейших мировых складов;
- Поставка более 17-ти миллионов наименований электронных компонентов;
- Поставка сложных, дефицитных, либо снятых с производства позиций;
- Оперативные сроки поставки под заказ (от 5 рабочих дней);
- Экспресс доставка в любую точку России;
- Техническая поддержка проекта, помощь в подборе аналогов, поставка прототипов;
- Система менеджмента качества сертифицирована по Международному стандарту ISO 9001;
- Лицензия ФСБ на осуществление работ с использованием сведений, составляющих государственную тайну;
- Поставка специализированных компонентов (Xilinx, Altera, Analog Devices, Intersil, Interpoint, Microsemi, Aeroflex, Peregrine, Syfer, Eurofarad, Texas Instrument, Miteq, Cobham, E2V, MA-COM, Hittite, Mini-Circuits, General Dynamics и др.);

Помимо этого, одним из направлений компании «ЭлектроПласт» является направление «Источники питания». Мы предлагаем Вам помощь Конструкторского отдела:

- Подбор оптимального решения, техническое обоснование при выборе компонента;
- Подбор аналогов;
- Консультации по применению компонента;
- Поставка образцов и прототипов;
- Техническая поддержка проекта;
- Защита от снятия компонента с производства.



Как с нами связаться

Телефон: 8 (812) 309 58 32 (многоканальный)

Факс: 8 (812) 320-02-42

Электронная почта: org@eplast1.ru

Адрес: 198099, г. Санкт-Петербург, ул. Калинина, дом 2, корпус 4, литера А.