



### Typical Applications

The HMC682LP6C(E) is Ideal for:

- Cellular/3G & LTE/WiMAX/4G
- Basestations & Repeaters
- GSM, CDMA & OFDM
- Dual Density Receivers

### Features

- High Input IP3: +25 dBm
- Conversion Gain: 6 dB
- Low LO Drive: 0 dBm
- High Channel Isolation
- 40 Lead 6x6mm SMT Package: 36mm<sup>2</sup>

### Functional Diagram

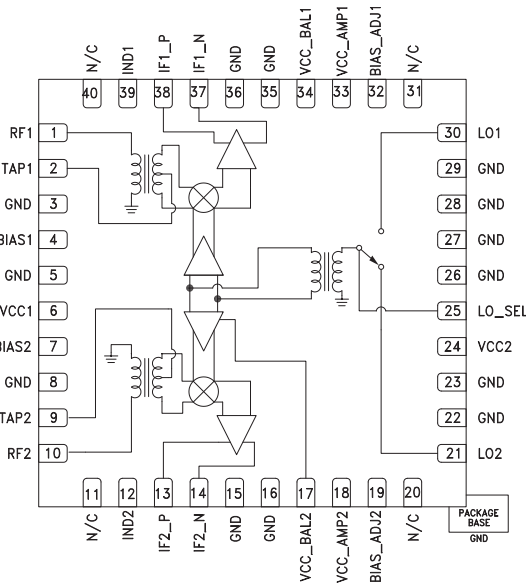

### General Description

The HMC682LP6C(E) is a high linearity, dual channel downconverter with integrated LO amplifier in a 6x6 SMT QFN package covering 1.7 - 2.2 GHz. Excellent input IP3 performance of +25 dBm for down conversion is provided for 3G & 4G GSM/CDMA applications at an LO drive of 0 dBm. With an input 1 dB compression of +15 dBm, the RF port will accept a wide range of input signal levels. Conversion gain is 6 dB typical. The 60 - 400 MHz IF frequency response will satisfy various GSM/CDMA receive frequency plans.

### Electrical Specifications, $T_A = +25\text{ }^\circ\text{C}$ , $IF = 200\text{ MHz}$ , $LO = 0\text{ dBm}$

$V_{cc1, 2} = V_{cc\_BAL1, 2} = V_{cc\_AMP1, 2}$  [1] =  $V_{cc\_IF1P, N} = V_{cc\_IF2P, N} = +5V$ ,  $BIAS1, 2 = +2.5V$

| Parameter                         | Min.        | Typ. | Max. | Units |
|-----------------------------------|-------------|------|------|-------|
| Frequency Range, RF               | 1.7 - 2.2   |      |      | GHz   |
| Frequency Range, LO               | 1.4 - 2.0   |      |      | GHz   |
| Frequency Range, IF               | 0.06 - 0.40 |      |      | GHz   |
| Conversion Gain                   | 4           | 6    |      | dB    |
| Noise Figure (SSB)                |             | 12   |      | dB    |
| LO to RF Isolation                | 17          | 25   |      | dB    |
| LO to IF Isolation                | 15          | 22   |      | dB    |
| RF to IF Isolation                | 15          | 30   |      | dB    |
| IP3 (Input)                       |             | 25   |      | dBm   |
| 1 dB Compression (Input)          |             | 15   |      | dBm   |
| Channel to Channel Isolation      |             | 55   |      | dB    |
| LO Drive Input Level (Typical)    | -3 to +3    |      |      | dBm   |
| Supply Current (I <sub>cc</sub> ) |             | 450  | 550  | mA    |

[1] See application circuit [2] Unless otherwise noted all measurements with low side LO & IF = 200 MHz.



**HIGH IP3 DUAL CHANNEL  
DOWNCONVERTER w/ LO SWITCH, 1.7 - 2.2 GHz**

**Single Channel:  
Conversion Gain vs. Temperature**

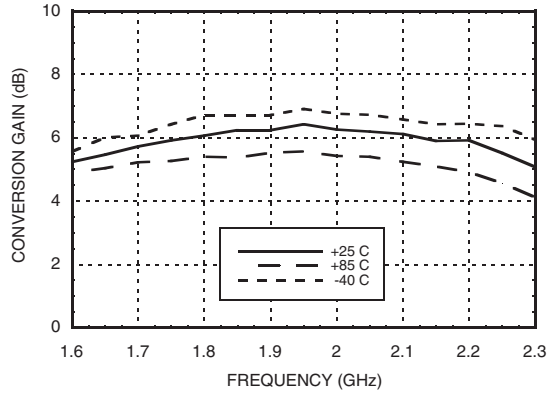

**Single Channel: Isolation**

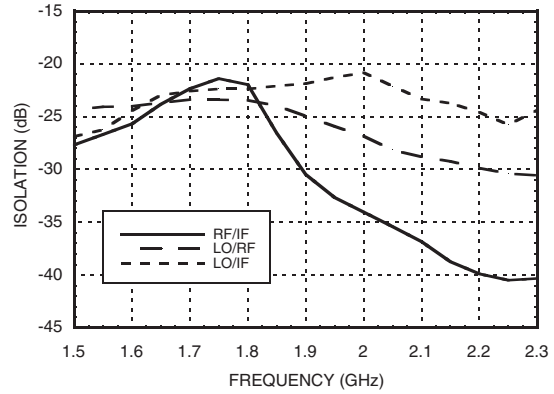

**Single Channel:  
Conversion Gain vs. LO Drive**

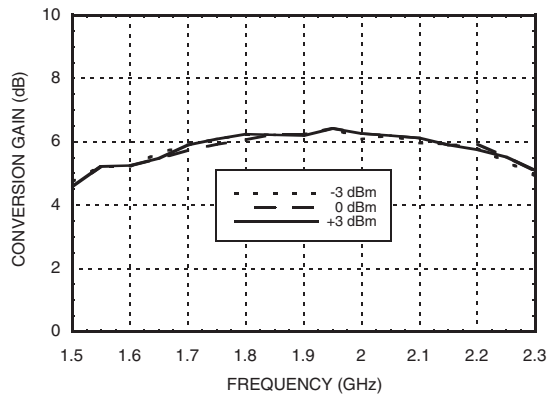

**Single Channel: Return Loss**

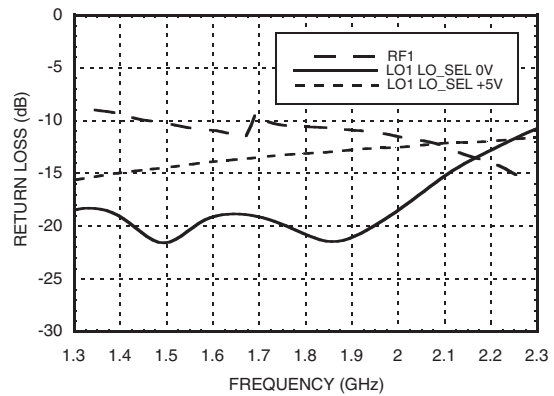

**Single Channel: IF Bandwidth**

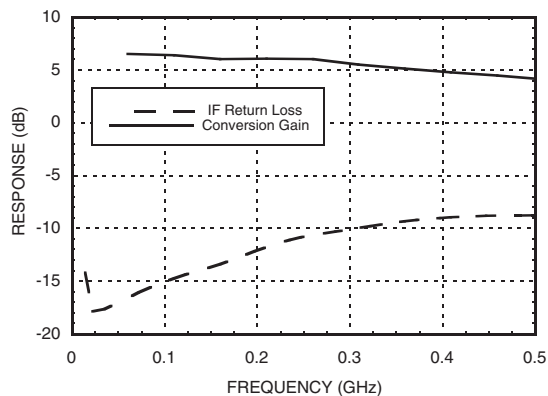

**Single Channel:  
Input P1dB vs. Temperature**

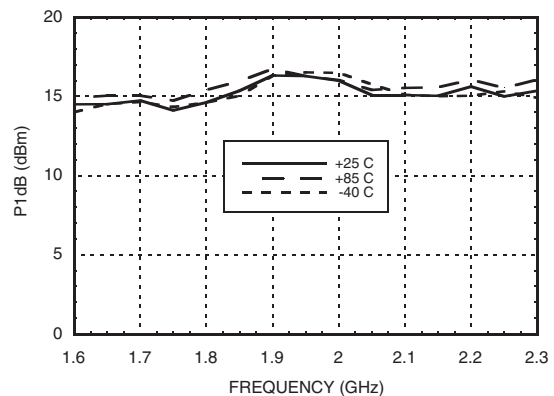

Information furnished by Analog Devices is believed to be accurate and reliable. However, no responsibility is assumed by Analog Devices for its use, nor for any infringements of patents or other rights of third parties that may result from its use. Specifications subject to change without notice. No license is granted by implication or otherwise under any patent or patent rights of Analog Devices. Trademarks and registered trademarks are the property of their respective owners.

For price, delivery, and to place orders: Analog Devices, Inc., One Technology Way, P.O. Box 9106, Norwood, MA 02062-9106 Phone: 781-329-4700 • Order online at [www.analog.com](http://www.analog.com) Application Support: Phone: 1-800-ANALOG-D



**HIGH IP3 DUAL CHANNEL  
DOWNCONVERTER w/ LO SWITCH, 1.7 - 2.2 GHz**

9

MIXERS - DOWNCONVERTERS - SMT

**Single Channel: Input IP3 vs. LO Drive**

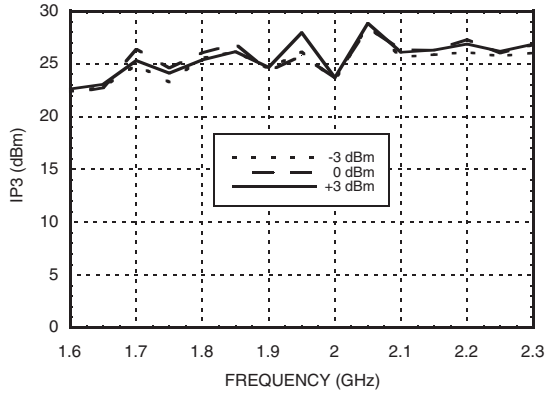

**Single Channel:  
Input IP3 vs. Temperature**

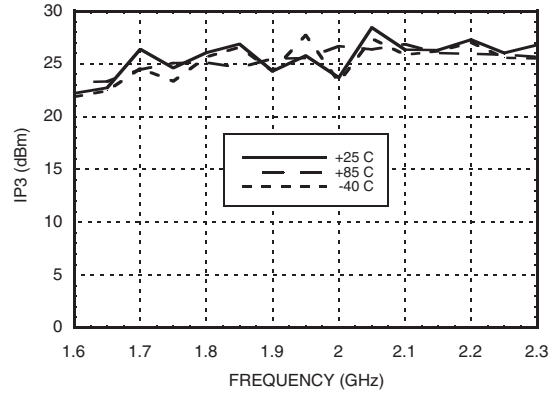

**Dual Channel:  
Channel to Channel Isolation<sup>[1]</sup>**

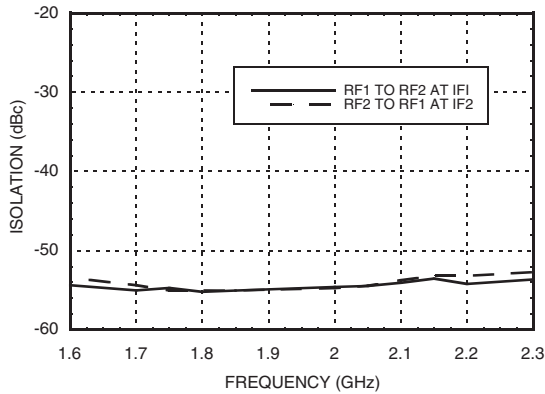

**Dual Channel: LO1 to LO2 Isolation<sup>[2]</sup>**

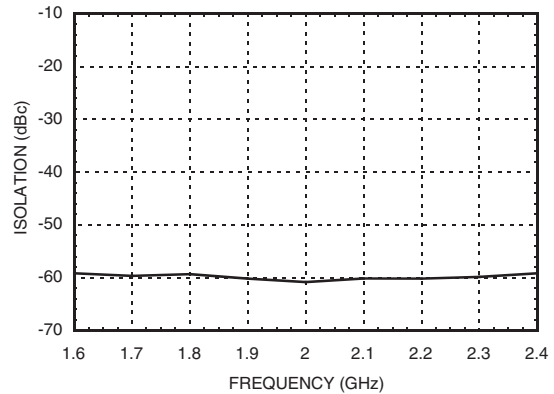

**Noise Figure vs. Temperature**

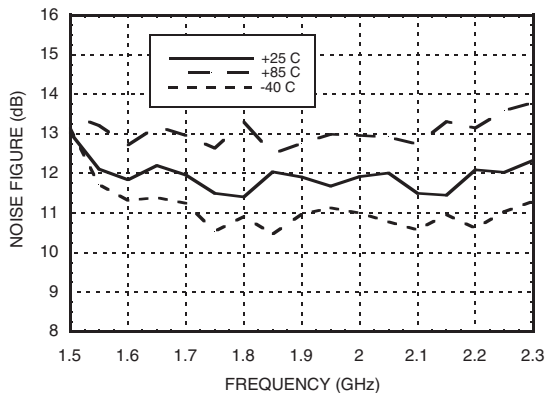

[1] For 1900 MHz, RF1 = 1900 MHz @ 0 dBm, RF2 = 1901 MHz @ 0 dBm, LO = 1700 MHz @ 0 dBm, IF2 terminated with 50 Ohms. Channel isolation is the dBc difference at IF1 port between the fundamental tone @ 200 MHz and the leakage tone at 201 MHz.

[2] For 1900 MHz, LO1 = 1700 MHz @ 0 dBm, LO2 = 1699 MHz @ 0 dBm, LO1 is selected, RF1 = RF2 = 1900 MHz @ 0 dBm, IF2 terminated with 50 Ohms. LO1-LO2 isolation is the dBc difference measured at the IF1 port between the fundamental tone at 200 MHz and the leakage tone at 201 MHz.



**HIGH IP3 DUAL CHANNEL  
DOWNCONVERTER w/ LO SWITCH, 1.7 - 2.2 GHz**

**+2RF -2LO Response vs. Temperature <sup>[3]</sup>**

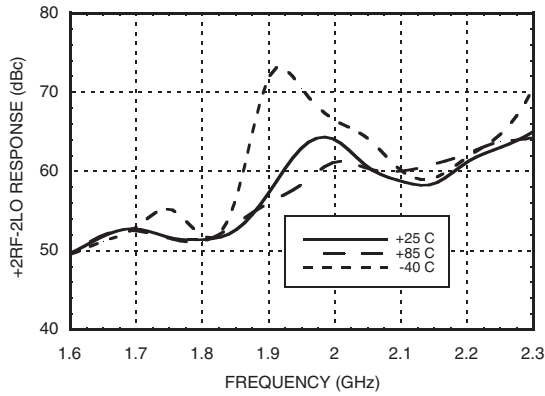

**+2RF -2LO Response vs. LO Drive <sup>[3]</sup>**

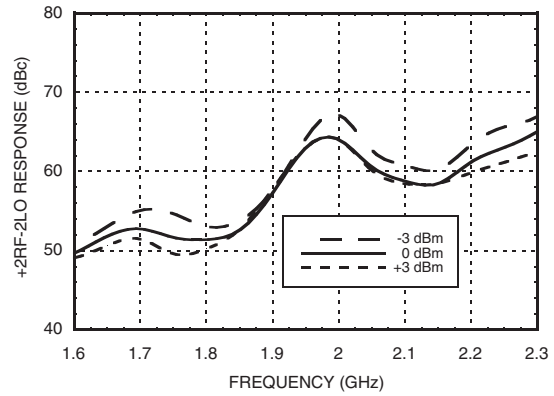

**+3RF -3LO Response vs. Temperature <sup>[3]</sup>**

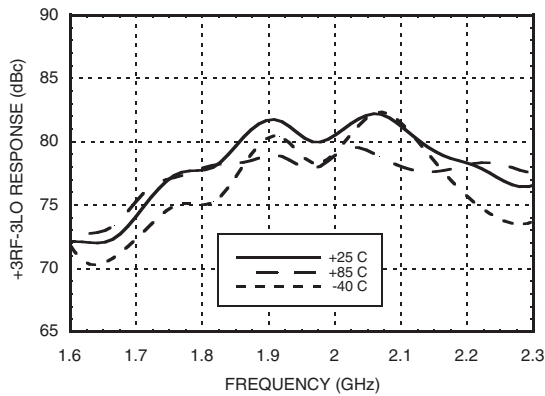

**+3RF -3LO Response vs. LO Drive <sup>[3]</sup>**

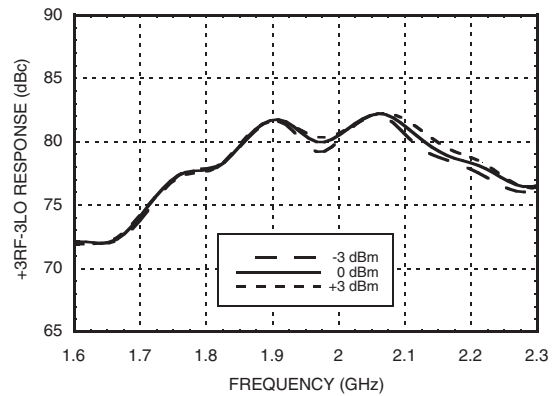

[3] Referenced to RF input power @ 0 dBm

**HIGH IP3 DUAL CHANNEL  
DOWNCONVERTER w/ LO SWITCH, 1.7 - 2.2 GHz**
**Harmonics of LO**

| LO Freq. (GHz) | nLO Spur @ RF Port |    |    |    |
|----------------|--------------------|----|----|----|
|                | 1                  | 2  | 3  | 4  |
| 1.4            | 25                 | 29 | 38 | 19 |
| 1.5            | 24                 | 28 | 31 | 21 |
| 1.6            | 25                 | 23 | 30 | 21 |
| 1.7            | 26                 | 19 | 38 | 14 |
| 1.8            | 29                 | 16 | 43 | 16 |
| 1.9            | 31                 | 15 | 40 | 19 |
| 2.0            | 32                 | 14 | 43 | 22 |

LO = 0 dBm  
All values in dBc below input LO level measured at RF port.

**MxN Spurious @ IF Port**

| mRF | nLO |     |     |     |     |
|-----|-----|-----|-----|-----|-----|
|     | 0   | 1   | 2   | 3   | 4   |
| 0   | xx  | 39  | 20  | 46  | 47  |
| 1   | 35  | 0   | 40  | 24  | 66  |
| 2   | 72  | 61  | 63  | 54  | 83  |
| 3   | 107 | 73  | 90  | 70  | 101 |
| 4   | 116 | 125 | 114 | 106 | 108 |

RF Freq. = 1.9 GHz @ -5 dBm  
LO Freq. = 1.7 GHz @ 0 dBm  
All values in dBc below IF power level (1RF - 1LO).

**Typical Supply Current vs. Vdd**

| Vcc  | Icc (mA) |
|------|----------|
| 4.75 | 415      |
| 5.00 | 450      |
| 5.25 | 490      |

Downconverter will operate over full voltage range shown above.

**Truth Table**

| LO_SEL (V) | LO Signal Path |
|------------|----------------|
| 0          | LO1            |
| 5          | LO2            |

## HIGH IP3 DUAL CHANNEL DOWNCONVERTER w/ LO SWITCH, 1.7 - 2.2 GHz



### Absolute Maximum Ratings

|   |               |
|---|---------------|
| RF / IF Input (Vcc= +5V)  | +15 dBm       |
| LO Drive (Vcc= +5V)   | +6 dBm        |
| Vcc (LO or IF)  | 5.5V          |
| Channel Temperature   | 12.5°C        |
| Continuous P <sub>diss</sub> (T = 85°C)<br>(derate 110.53 mW/°C above 85°C) | 4.42 W        |
| Thermal Resistance<br>(channel to ground paddle)                            | 9.05 °C/W     |
| Storage Temperature   | -65 to 150°C  |
| Operating Temperature   | -40 to +85 °C |



ELECTROSTATIC SENSITIVE DEVICE  
OBSERVE HANDLING PRECAUTIONS

9

### Outline Drawing

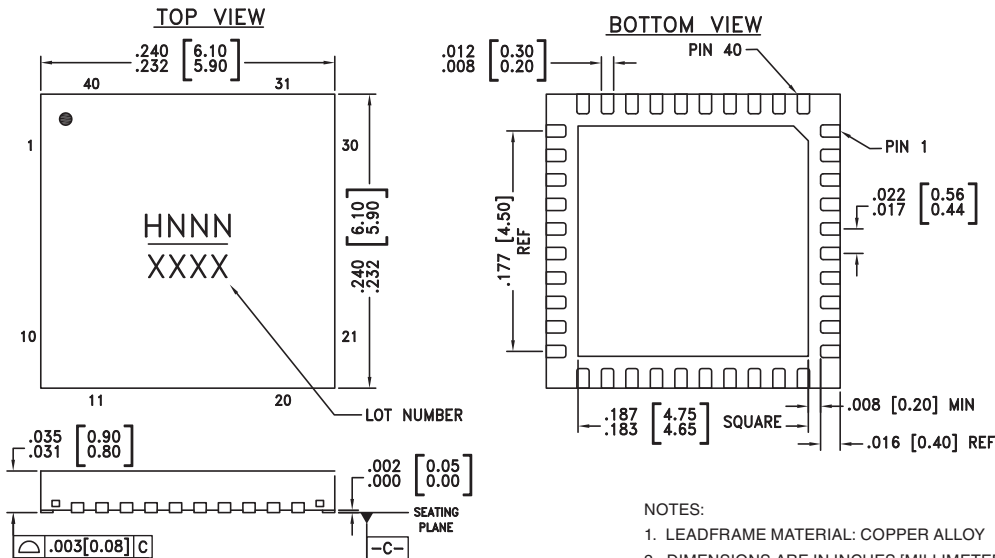

NOTES:

1. LEADFRAME MATERIAL: COPPER ALLOY
2. DIMENSIONS ARE IN INCHES [MILLIMETERS]
3. LEAD SPACING TOLERANCE IS NON-CUMULATIVE.
4. PAD BURR LENGTH SHALL BE 0.15mm MAXIMUM.  
PAD BURR HEIGHT SHALL BE 0.05mm MAXIMUM.
5. PACKAGE WARP SHALL NOT EXCEED 0.05mm.
6. ALL GROUND LEADS AND GROUND PADDLE MUST BE SOLDERED TO PCB RF GROUND.
7. REFER TO HITTITE APPLICATION NOTE FOR SUGGESTED LAND PATTERN.

### Package Information

| Part Number | Package Body Material                              | Lead Finish   | MSL Rating          | Package Marking <sup>[3]</sup> |
|-------------|--|---------------|---------------------|--------------------------------|
| HMC682LP6C  | Low Stress Injection Molded Plastic                | Sn/Pb Solder  | MSL1 <sup>[1]</sup> | H682<br>XXXX                   |
| HMC682LP6CE | RoHS-compliant Low Stress Injection Molded Plastic | 100% matte Sn | MSL1 <sup>[2]</sup> | H682<br>XXXX                   |

[1] Max peak reflow temperature of 235 °C







[2] Max peak reflow temperature of 260 °C

[3] 4-Digit lot number XXXX

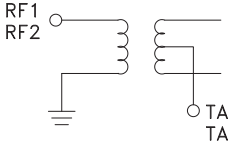
## HIGH IP3 DUAL CHANNEL DOWNCONVERTER w/ LO SWITCH, 1.7 - 2.2 GHz

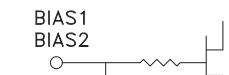
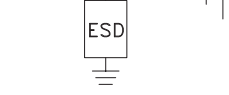
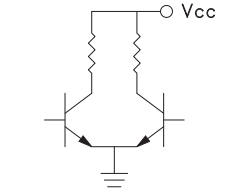
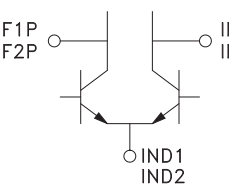

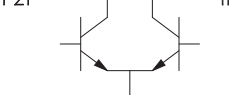
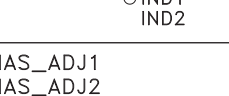
### Pin Descriptions

| Pin Number                                     | Function  | Description   | Interface Schematic   |
|--|---|---|---|
| 1, 10  | RF1, RF2  | These are the RF inputs of the mixers. See application circuit for the off-chip matching components   |    |
| 2, 9   | TAP1, TAP2  | These are the center taps of the internal RF baluns. Connect these pins to the AC ground via external capacitors. See application circuit.  |    |
| 3, 5, 8, 15,<br>16, 22, 23,<br>26 - 29, 36, 35 | GND   | These pins must be connected to RF ground.  |    |
| 4, 7   | BIAS1, BIAS2  | Bias pins for mixer cores. See application circuit for the nominal value.   |    |
| 6, 17, 18,<br>24, 33, 34                       | Vcc1, Vcc_BAL2,<br>Vcc_AMP2,<br>Vcc2, Vcc_AMP1,<br>Vcc_BAL1 | Power supply voltage pins. See application circuit for required external components.  |   |
| 11, 20, 31, 40                                 | N/C   | No Connection required. These pins may be connected to RF GND without affecting performance.  |   |
| 12, 39   | IND1, IND2  | Current source inductors for IF amplifiers.   |  |
| 13, 14,<br>38, 37                              | IF2P, IF2N,<br>IF1P, IF1N                                   | Differential IF outputs and DC BIAS for IF Amps.  |  |
| 19, 32   | BIAS_ADJ1,<br>BIAS_ADJ2                                     | Adjusts LO buffer amplifies current via external resistor. See application circuit.   |  |
| 21, 30   | LO2, LO1  | These are LO inputs of the mixers. See application circuit for off-chip matching components.  |  |
| 25   | LO_SEL  | Control voltage for LO1 or LO2 selection. LO1 is selected when LO SEL is set low. LO2 is selected when LO SEL is set high. See application circuit and truth table for low and high voltage levels. |  |



**HIGH IP3 DUAL CHANNEL  
DOWNCONVERTER w/ LO SWITCH, 1.7 - 2.2 GHz**

**Evaluation PCB**

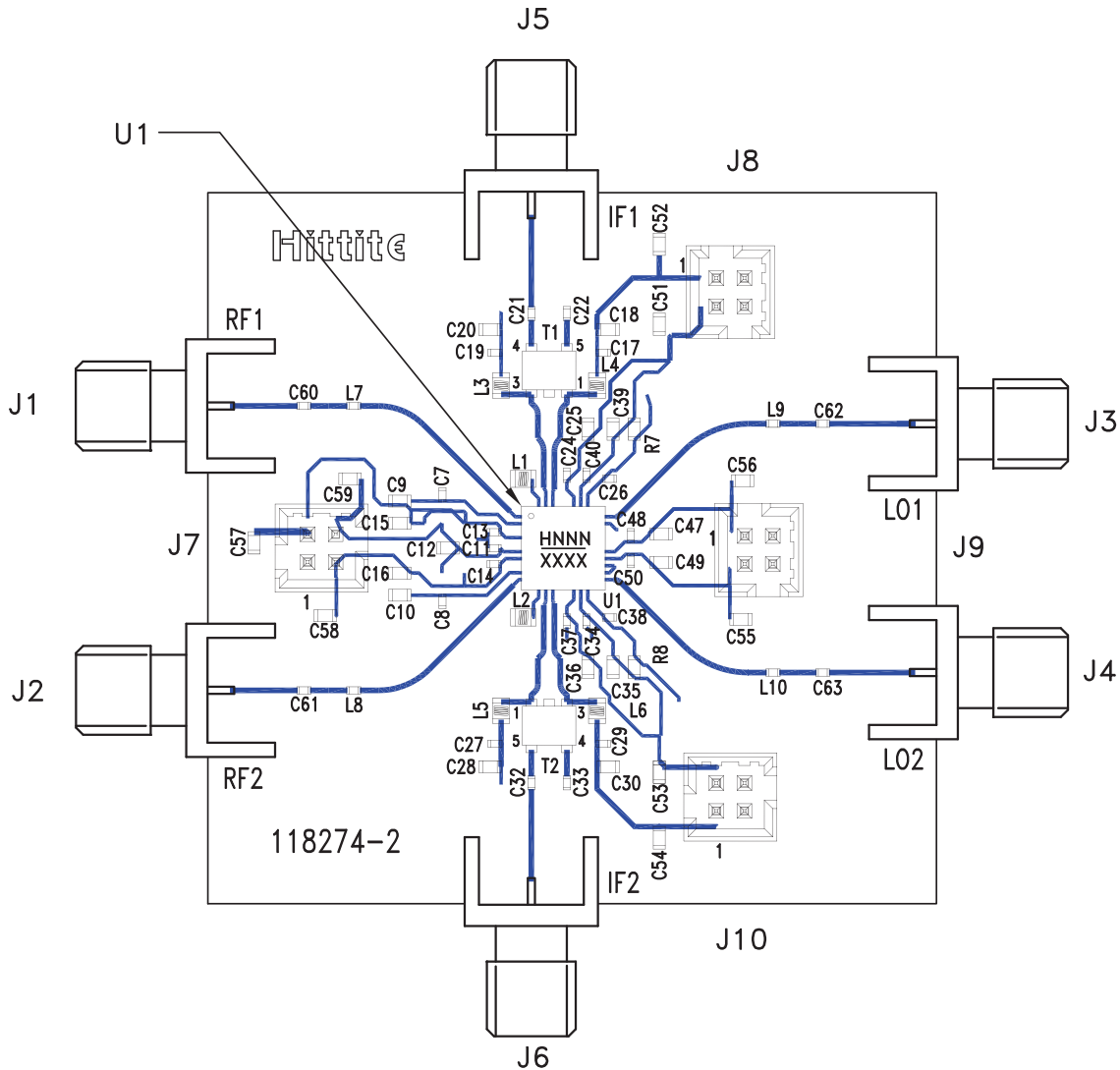

The circuit board used in the final application should use RF circuit design techniques. Signal lines should have 50 Ohm impedance while the package ground leads and exposed paddle should be connected directly to the ground plane similar to that shown. A sufficient number of via holes should be used to connect the top and bottom ground planes. The evaluation circuit board shown is available from Hittite upon request.

Information furnished by Analog Devices is believed to be accurate and reliable. However, no responsibility is assumed by Analog Devices for its use, nor for any infringements of patents or other rights of third parties that may result from its use. Specifications subject to change without notice. No license is granted by implication or otherwise under any patent or patent rights of Analog Devices. Trademarks and registered trademarks are the property of their respective owners.

For price, delivery, and to place orders: Analog Devices, Inc., One Technology Way, P.O. Box 9106, Norwood, MA 02062-9106 Phone: 781-329-4700 • Order online at [www.analog.com](http://www.analog.com) Application Support: Phone: 1-800-ANALOG-D



**HIGH IP3 DUAL CHANNEL  
DOWNCONVERTER w/ LO SWITCH, 1.7 - 2.2 GHz**
**List of Materials for Evaluation PCB 119925 [1]**

| Item  | Description                       |
|---|-----------------------------------|
| J1 - J6   | PCB Mount SMA Connector           |
| J7 - J10  | 2mm Vertical Molex 8pc Connector  |
| L1, L2  | 51 nH Inductor, 0603 Pkg.         |
| L3 - L6   | 390 nH Inductor, 0603 Pkg.        |
| L7 - L10  | 2.2 nH Inductor, 0402 Pkg.        |
| C7, C8, C26, C38  | 22 pF Capacitor, 0402 Pkg.        |
| C9, C10   | 10 nF Capacitor, 0603 Pkg.        |
| C11, C17, C19, C24, C27, C29, C34, C37, C40, C48, C50           | 1 nF Capacitor, 0402 Pkg.         |
| C12, C15, C16, C18, C20, C25, C28, C30, C35, C36, C39, C47, C49 | 0.1 $\mu$ F Capacitor, 0603 Pkg.  |
| C13, C14, C60 - C63   | 100 pF Capacitor, 0402 Pkg.       |
| C21, C22, C32, C33  | 0.01 $\mu$ F Capacitor, 0402 Pkg. |
| C51 - C59   | 0.47 $\mu$ F Capacitor, 0603 Pkg. |
| R7, R8  | 330 Ohm Resistor, 0603 Pkg.       |
| T1, T2  | 1:1 Transformer - Tyco ETC1-1T    |
| U1  | HMC682LP6C(E)                     |
| PCB [2]   | 118274 Evaluation PCB             |

[1] Reference this number when ordering complete evaluation PCB

[2] Circuit Board Material: Arlon-25FR and FR4

**HIGH IP3 DUAL CHANNEL  
DOWNCONVERTER w/ LO SWITCH, 1.7 - 2.2 GHz**



**Application Circuit**

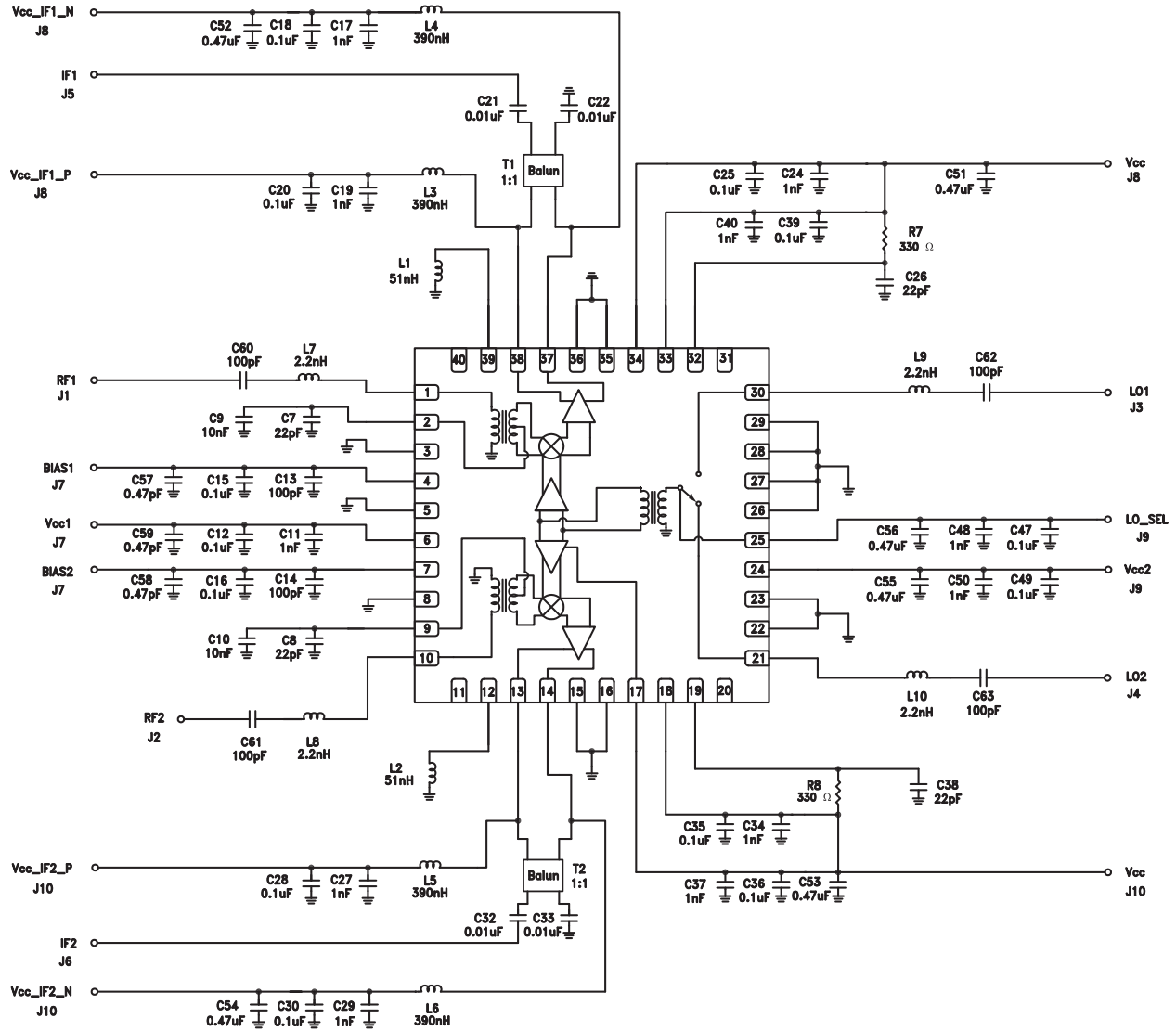

Information furnished by Analog Devices is believed to be accurate and reliable. However, no responsibility is assumed by Analog Devices for its use, nor for any infringements of patents or other rights of third parties that may result from its use. Specifications subject to change without notice. No license is granted by implication or otherwise under any patent or patent rights of Analog Devices. Trademarks and registered trademarks are the property of their respective owners.

For price, delivery, and to place orders: Analog Devices, Inc., One Technology Way, P.O. Box 9106, Norwood, MA 02062-9106 Phone: 781-329-4700 • Order online at [www.analog.com](http://www.analog.com) Application Support: Phone: 1-800-ANALOG-D



Компания «ЭлектроПласт» предлагает заключение долгосрочных отношений при поставках импортных электронных компонентов на взаимовыгодных условиях!

Наши преимущества:

- Оперативные поставки широкого спектра электронных компонентов отечественного и импортного производства напрямую от производителей и с крупнейших мировых складов;
- Поставка более 17-ти миллионов наименований электронных компонентов;
- Поставка сложных, дефицитных, либо снятых с производства позиций;
- Оперативные сроки поставки под заказ (от 5 рабочих дней);
- Экспресс доставка в любую точку России;
- Техническая поддержка проекта, помощь в подборе аналогов, поставка прототипов;
- Система менеджмента качества сертифицирована по Международному стандарту ISO 9001;
- Лицензия ФСБ на осуществление работ с использованием сведений, составляющих государственную тайну;
- Поставка специализированных компонентов (Xilinx, Altera, Analog Devices, Intersil, Interpoint, Microsemi, Aeroflex, Peregrine, Syfer, Eurofarad, Texas Instrument, Miteq, Cobham, E2V, MA-COM, Hittite, Mini-Circuits, General Dynamics и др.);

Помимо этого, одним из направлений компании «ЭлектроПласт» является направление «Источники питания». Мы предлагаем Вам помощь Конструкторского отдела:

- Подбор оптимального решения, техническое обоснование при выборе компонента;
- Подбор аналогов;
- Консультации по применению компонента;
- Поставка образцов и прототипов;
- Техническая поддержка проекта;
- Защита от снятия компонента с производства.



#### Как с нами связаться

**Телефон:** 8 (812) 309 58 32 (многоканальный)

**Факс:** 8 (812) 320-02-42

**Электронная почта:** [org@eplast1.ru](mailto:org@eplast1.ru)

**Адрес:** 198099, г. Санкт-Петербург, ул. Калинина, дом 2, корпус 4, литера А.