

SMPS Stacked MLC Capacitors



(SM Style) Technical Information on SMPS Capacitors

ELECTRICAL SPECIFICATIONS

Temperature Coefficient

C0G: A Temperature Coefficient - 0 ±30 ppm/°C, -55° to +125°C
 X7R: C Temperature Coefficient - ±15%, -55° to +125°C
 Z5U: E Temperature Coefficient - +22, -56%, +10° to +85°C

Capacitance Test (MIL-STD-202 Method 305)

C0G: 25°C, 1.0±0.2 Vrms (open circuit voltage) at 1KHz
 X7R: 25°C, 1.0±0.2 Vrms (open circuit voltage) at 1KHz
 Z5U: 25°C, 0.5 Vrms max (open circuit voltage) at 1KHz

Dissipation Factor 25°C

C0G: 0.15% Max @ 25°C, 1.0±0.2 Vrms (open circuit voltage) at 1KHz
 X7R: 2.5% Max @ 25°C, 1.0±0.2 Vrms (open circuit voltage) at 1KHz
 Z5U: 3.0% Max @ 25°C, 0.5 Vrms max (open circuit voltage) at 1KHz

Insulation Resistance 25°C (MIL-STD-202 Method 302)

C0G and X7R: 100K MΩ or 1000 MΩ-μF, whichever is less.
 Z5U: 10K MΩ or 1000 MΩ-μF, whichever is less.

Insulation Resistance 125°C (MIL-STD-202 Method 302)

C0G and X7R: 10K MΩ or 100 MΩ-μF, whichever is less.
 Z5U: 1K MΩ or 100 MΩ-μF, whichever is less.

Dielectric Withstanding Voltage 25°C (Flash Test)

C0G and X7R: 250% rated voltage for 5 seconds with 50 mA max charging current. (500 Volt units @ 750 VDC)

Z5U: 200% rated voltage for 5 seconds with 50 mA max charging current.

Life Test (1000 hrs)

C0G and X7R: 200% rated voltage at +125°C. (500 Volt units @ 600 VDC)

Z5U: 150% rated voltage at +85°C

Moisture Resistance (MIL-STD-202 Method 106)

C0G, X7R, Z5U: Ten cycles with no voltage applied.

Thermal Shock (MIL-STD-202 Method 107, Condition A)

Immersion Cycling (MIL-STD-202 Method 104, Condition B)

Resistance To Solder Heat (MIL-STD-202, Method 210, Condition B, for 20 seconds)

Not RoHS Compliant

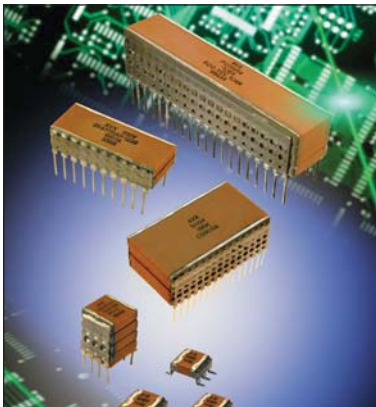

Typical ESR Performance (mΩ)

	Aluminum Electrolytic 100μF/50V	Low ESR Solid Tantalum 100μF/10V	Solid Aluminum Electrolytic 100μF/16V	MLCC SMPS 100μF/50V	MLCC SMPS 4.7μF/50V
ESR @ 10KHz	300	72	29	3	66
ESR @ 50KHz	285	67	22	2	23
ESR @ 100KHz	280	62	20	2.5	15
ESR @ 500KHz	265	56	18	4	8
ESR @ 1MHz	265	56	17	7	7.5
ESR @ 5MHz	335	72	17	12.5	8
ESR @ 10MHz	560	91	22	20	14

HOW TO ORDER

AVX Styles: SM-1, SM-2, SM-3, SM-4, SM-5, SM-6

SM0	1	7	C	106	M	A	N	650
AVX Style	Size	Voltage	Temperature Coefficient	Capacitance Code	Capacitance Tolerance	Test Level	Termination	Height
SM0 = Uncoated SM5 = Epoxy Coated	See Dimensions chart	50V = 5 100V = 1 200V = 2 500V = 7	C0G = A X7R = C Z5U = E	(2 significant digits + number of zeros) 10 pF = 100 100 pF = 101 1,000 pF = 102 22,000 pF = 223 220,000 pF = 224 1μF = 105 10 μF = 106 100 μF = 107	C0G: J = ±5% K = ±10% M = ±20% X7R: K = ±10% M = ±20% Z = +80%, -20% Z5U: M = ±20% Z = +80%, -20% P = GMV (+100, -0%)	A = Standard B = Hi-Rel* 5 = Standard/MIL** 6 = Hi-Rel/MIL***	N = Straight Lead J = Leads formed in L = Leads formed out P = P Style Leads Z = Z Style Leads	Max Dimension "A" 120 = 0.120" 240 = 0.240" 360 = 0.360" 480 = 0.480" 650 = 0.650"

Note: Capacitors with X7R and Z5U dielectrics are not intended for applications across AC supply mains or AC line filtering with polarity reversal. Contact plant for recommendations.

* Hi-Rel screening for C0G and X7R only. Screening consists of 100% Group A (B Level), Subgroup 1 per MIL-PRF-49470.

** Form, fit & function equivalent to MIL-PRF-49470 part. Applies to 50V rated parts only. No screening.

*** Form, fit & function equivalent to MIL-PRF-49470 part. Applies to 50V rated parts only. Hi-Rel screening the same as option B.



Performance of SMPS capacitors can be simulated by downloading SpiCalci software program -

<http://www.avx.com/SpiApps/default.asp#spicalci>

Custom values, ratings and configurations are also available.



SMPS Stacked MLC Capacitors



(SM Style) Surface Mount and Thru-Hole Styles (SM0, SM5)

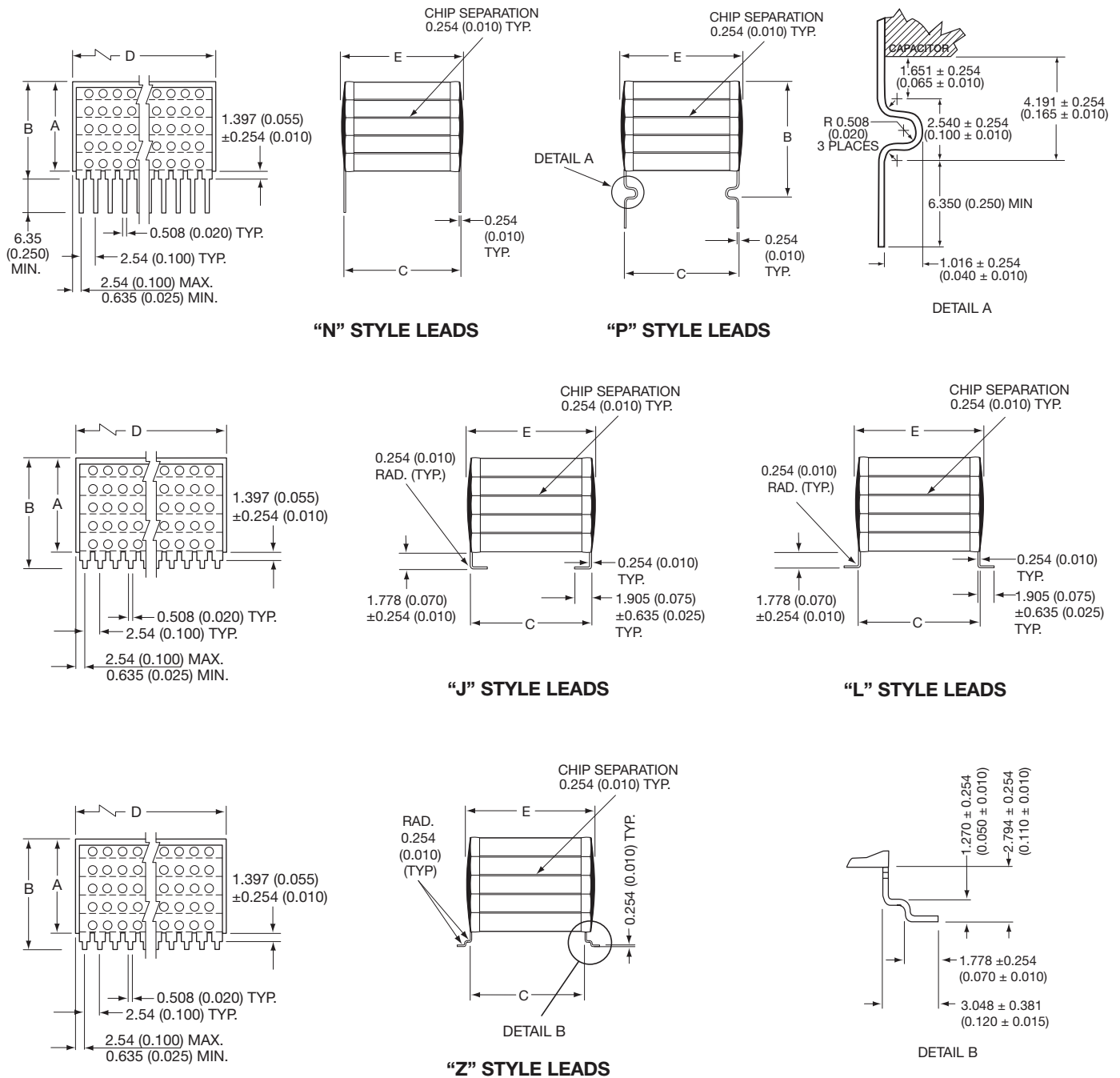

DIMENSIONS

millimeters (inches)

Style	A (max.)	B (max.)	C ±.635 (±0.025)	D ±.635 (±0.025)	E (max.)	No. of Leads per side
SM-1	See page 10 for maximum "A" Dimension	For "N" Style Leads: "A" Dimension Plus 1.651 (0.065) For "J" & "L" Style Leads: "A" Dimension Plus 2.032 (0.080) For "P" Style Leads: "A" Dimension Plus 4.445 (0.175) For "Z" Style Leads: "A" Dimension Plus 3.048 (0.120)	11.4 (0.450)	52.1 (2.050)	12.7 (0.500)	20
SM-2			20.3 (0.800)	38.4 (1.510)	22.1 (0.870)	15
SM-3			11.4 (0.450)	26.7 (1.050)	12.7 (0.500)	10
SM-4			10.2 (0.400)	10.2 (0.400)	11.2 (0.440)	4
SM-5			6.35 (0.250)	6.35 (0.250)	7.62 (0.300)	3
SM-6			31.8 (1.250)	52.1 (2.050)	34.3 (1.350)	20

Note: For SM5 add 0.127 (0.005) to max. and nominal dimensions A, B, D, & E



SMPS Stacked MLC Capacitors



(SM Style)

Max Capacitance (μF) Available Versus Style with Height (A) of 0.120" - 3.05mm

AVX STYLE	SM01 _____ AN120				SM02 _____ AN120				SM03 _____ AN120				SM04 _____ AN120				SM05 _____ AN120				SM06 _____ AN120							
	50V	100V	200V	500V	50V	100V	200V	500V	50V	100V	200V	500V	50V	100V	200V	500V	50V	100V	200V	500V	50V	100V	200V	500V	50V	100V	200V	500V
C0G	1.0	.70	.40	.18	1.2	1.0	.60	.26	.47	.40	.20	.09	.16	.13	.07	.02	.05	.04	.02	.01	3.2	2.4	1.3	.50				
X7R	27	12	7.0	2.6	41	18	11	4.0	18	6.0	3.6	1.3	7.5	1.8	1.1	.40	2.8	.68	.40	.16	80	40	24	9.4				
Z5U	84	32	12	--	110	46	34	--	40	15	6.0	--	12	4.6	3.0	--	4.6	1.8	.72	--	260	140	92	--				

Max Capacitance (μF) Available Versus Style with Height (A) of 0.240" - 6.10mm

AVX STYLE	SM01 _____ AN240				SM02 _____ AN240				SM03 _____ AN240				SM04 _____ AN240				SM05 _____ AN240				SM06 _____ AN240							
	50V	100V	200V	500V	50V	100V	200V	500V	50V	100V	200V	500V	50V	100V	200V	500V	50V	100V	200V	500V	50V	100V	200V	500V	50V	100V	200V	500V
C0G	2.0	1.4	.80	.36	2.4	2.0	1.2	.52	1.0	.80	.40	.18	.32	.26	.14	.05	.10	.08	.05	.02	6.4	4.8	2.6	1.0				
X7R	54	24	14	5.2	82	36	22	8.0	36	12	7.2	2.6	15	3.6	2.2	.80	5.6	1.3	.80	.32	160	80	48	18				
Z5U	160	64	24	--	230	92	68	--	80	30	12	--	24	9.2	6.0	--	9.2	3.6	1.4	--	520	280	180	--				

Max Capacitance (μF) Available Versus Style with Height (A) of 0.360" - 9.14mm

AVX STYLE	SM01 _____ AN360				SM02 _____ AN360				SM03 _____ AN360				SM04 _____ AN360				SM05 _____ AN360				SM06 _____ AN360							
	50V	100V	200V	500V	50V	100V	200V	500V	50V	100V	200V	500V	50V	100V	200V	500V	50V	100V	200V	500V	50V	100V	200V	500V	50V	100V	200V	500V
C0G	3.0	2.1	1.2	.54	3.6	3.0	1.8	.78	1.5	1.2	.60	.27	.48	.39	.21	.07	.15	.12	.07	.03	9.6	7.2	3.9	1.5				
X7R	82	36	21	7.8	120	54	33	12	54	18	10	3.9	22	5.4	3.3	1.2	8.2	2.0	1.2	.48	240	120	72	28				
Z5U	250	96	36	--	350	130	100	--	120	45	18	--	36	13	9.0	--	13	5.4	2.1	--	780	430	270	--				

Max Capacitance (μF) Available Versus Style with Height (A) of 0.480" - 12.2mm

AVX STYLE	SM01 _____ AN480				SM02 _____ AN480				SM03 _____ AN480				SM04 _____ AN480				SM05 _____ AN480				SM06 _____ AN480							
	50V	100V	200V	500V	50V	100V	200V	500V	50V	100V	200V	500V	50V	100V	200V	500V	50V	100V	200V	500V	50V	100V	200V	500V	50V	100V	200V	500V
C0G	4.0	2.8	1.6	.72	4.8	4.0	2.2	1.0	2.0	1.6	.80	.36	.64	.52	.28	.10	.20	.16	.10	.04	12	9.6	5.2	2.0				
X7R	110	48	28	10	160	72	44	16	72	24	14	5.2	30	7.2	4.4	1.6	10	2.7	1.6	.64	320	160	96	37				
Z5U	330	120	48	--	470	180	130	--	160	60	24	--	48	18	12	--	18	7.2	2.8	--	1000	570	360	--				

Max Capacitance (μF) Available Versus Style with Height (A) of 0.650" - 16.5mm

AVX STYLE	SM01 _____ AN650				SM02 _____ AN650				SM03 _____ AN650				SM04 _____ AN650				SM05 _____ AN650				SM06 _____ AN650							
	50V	100V	200V	500V	50V	100V	200V	500V	50V	100V	200V	500V	50V	100V	200V	500V	50V	100V	200V	500V	50V	100V	200V	500V	50V	100V	200V	500V
C0G	5.0	3.5	2.0	.90	6.0	5.0	3.0	1.3	2.5	2.0	1.0	.47	.80	.65	.35	.12	.25	.20	.12	.05	16	12	6.5	2.5				
X7R	130	60	35	13	200	90	55	20	90	30	18	6.5	36	9.0	5.5	2.0	12	3.4	2.0	.80	400	200	120	47				
Z5U	420	160	60	--	590	230	170	--	200	75	30	--	60	23	15	--	23	9.0	3.6	--	1300	720	460	--				

SMPS Stacked MLC Capacitors



SM “S” Style Leads (SM0, SM5)

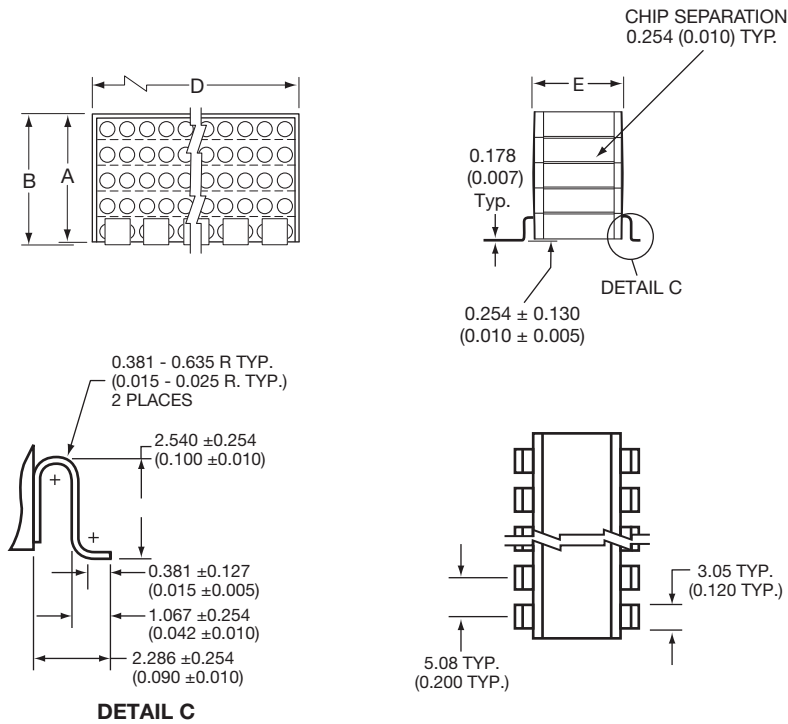

“S” STYLE LEADS

DIMENSIONS

millimeters (inches)

Style	A (max.)	B (max.)	D ±.635 (±0.025)	E (max.)	No. of Leads per side
SM-3	See page 10 for maximum “A”	For “S” Style Leads: “A” Dimension Plus 0.381 (0.015) Dimension	26.7 (1.050)	12.7 (0.500)	5
SM-4			10.2 (0.400)	11.2 (0.440)	2
SM-5			6.35 (0.250)	7.62 (0.300)	1

Note: For SM5 add 0.127 (0.005) to max. and nominal dimensions A, B, D, & E

SMPS Stacked MLC Capacitors



(SM Style) SM Military Styles MIL-PRF-49470

AVX IS QUALIFIED TO MIL-PRF-49470/1 AND MIL-PRF-49470/2

The SMPS capacitors are designed for high current, high-power and high-temperature applications. These capacitors have very low ESR (Equivalent Series Resistance) and ESL (Equivalent Series Inductance). SMPS Series capacitors offer design and component engineers a proven technology specifically designed for programs requiring high reliability performance in harsh environments.

MIL-PRF-49470 SMPS Series capacitors are primarily used in input/output filters of high-power and high-voltage power supplies as well as in bus filters and DC snubbers for high power inverters and other high-current applications. These capacitors are available with through-hole and surface mount leads. The operating temperature is -55°C to +125°C.

The MIL-PRF-49470 capacitors are preferred over the DSCC drawing 87106 capacitors. MIL-PRF-49470 specification was created to produce a robust replacement for DSCC 87106. MIL-PRF-49470 offers two product levels.

Level "B" is the standard reliability. Level "T" is the high reliability suitable for space application.

AVX is qualified to supply MIL-PRF-49470/1 parts. These are unencapsulated ceramic dielectric, switch mode power supply capacitors. AVX is also qualified to supply MIL-PRF-49470/2 parts. These are encapsulated ceramic dielectric, switch mode power supply capacitors.

PLEASE CONTACT THE DLA WEBSITE

<http://www.landandmaritime.dla.mil/programs/milspec/DocSearch.aspx> for details on testing, electrical, mechanical and part number options.

PLEASE CONTACT THE DLA WEBSITE

<http://www.landandmaritime.dla.mil/Programs/QmlQpl/> for the latest QPL (Qualified Products List).

Not RoHS Compliant

HOW TO ORDER

M49470	R	01	474	K	C	N
Performance specification indicating MIL-PRF-49470	Characteristic P = BP Q = BQ R = BR X = BX	Performance specification sheet number 01 – indicating MIL-PRF-49470/1 02 – indicating MIL-PRF-49470/2	Capacitance	Capacitance Tolerance K = 10% M = 20%	Rated Voltage Z = 25V A = 50V B = 100V C = 200V E = 500V	Configuration (Lead Style) See chart for Lead configurations

For "T" level parts, replace the "M" in the pin with "T" (for example M49470R01474KCN becomes T49470R01474KCN) MIL-PRF-49470 contains additional capacitors that are not available in 87106, such as additional lead configurations and lower profile parts.

"T" level for 25V under qualification. Availability and updates upon request.

On the pages to follow is the general dimensional outline along with a cross reference from 87106 parts to MIL-PRF-49470 parts.

LEAD CONFIGURATION

millimeters (inches)

Symbol (Last digit of military PN, 12th digit of AVX PN)	Lead Style	Height Profile (Dimension A)	Formed lead length, L
N	N (straight)	Standard	N/A
L	L (formed)	Standard	1.78 ± 0.25 (0.070 ± 0.010)
M	L (formed)	Standard	1.14 ± 0.25 (0.045 ± 0.010)
J	J (formed)	Standard	1.78 ± 0.25 (0.070 ± 0.010)
K	J (formed)	Standard	1.14 ± 0.25 (0.045 ± 0.010)
A	N (straight)	Low	N/A
B	L (formed)	Low	1.78 ± 0.25 (0.070 ± 0.010)
D	L (formed)	Low	1.14 ± 0.25 (0.045 ± 0.010)
C	J (formed)	Low	1.78 ± 0.25 (0.070 ± 0.010)
F	J (formed)	Low	1.14 ± 0.25 (0.045 ± 0.010)

Note: Lead options available marked with a "-" as a place holder. See lead configuration column for available lead options to replace the "-".



Performance of SMPS capacitors can be simulated by downloading SpiCalci software program - <http://www.avx.com/SpiApps/default.asp#spicalci>



SMPS Stacked MLC Capacitors



(SM Style) SM Military Styles MIL-PRF-49470/1

MIL-PRF-49470/1

MIL-PRF-49470/1 - capacitor, fixed, ceramic dielectric, switch mode power supply (general purpose and temperature stable), standard reliability and high reliability unencapsulated, Style PS01.

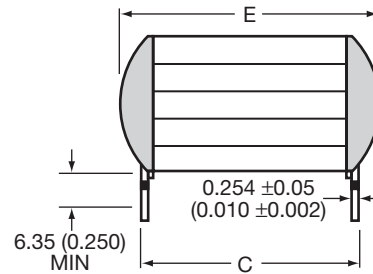
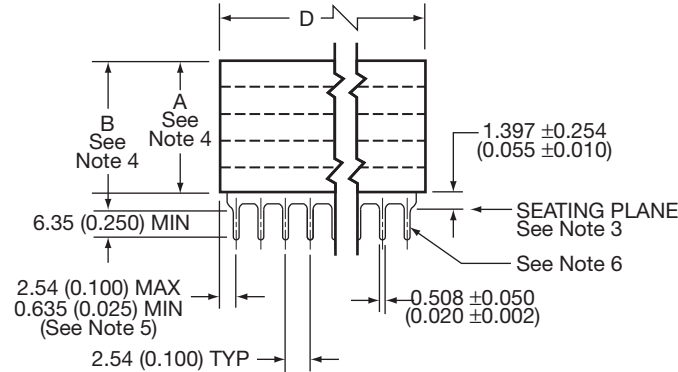

LEAD STYLE N AND A

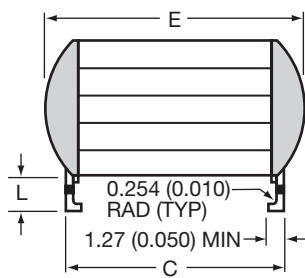

LEAD STYLE J AND C

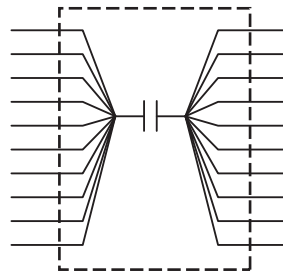

CIRCUIT DIAGRAM

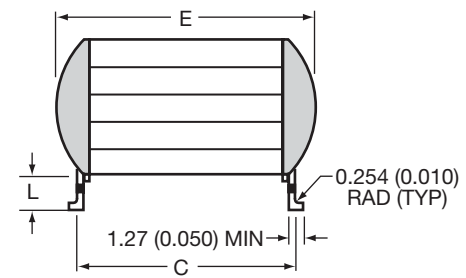

LEAD STYLE L AND B

DIMENSIONS:

millimeters (inches)

Case Code	C ±0.635 (±0.025)	D		E (max.)	Number of Leads per side
		Min.	Max.		
1	11.4 (0.450)	49.5 (1.950)	52.7 (2.075)	12.7 (0.500)	20
2	20.3 (0.800)	36.8 (1.450)	40.0 (1.535)	22.1 (0.870)	15
3	11.4 (0.450)	24.1 (0.950)	27.3 (1.075)	12.7 (0.500)	10
4	10.2 (0.400)	8.89 (0.350)	10.8 (0.425)	11.2 (0.440)	4
5	6.35 (0.250)	6.20 (0.224)	6.97 (0.275)	7.62 (0.300)	3
6	31.8 (1.250)	49.5 (1.950)	52.7 (2.075)	34.3 (1.350)	20

NOTES:

- Dimensions are in millimeters (inches)
- Unless otherwise specified, tolerances are 0.254 (±0.010).
- Lead frame configuration is shown as typical above the seating plane.
- See table I of MIL-PRF-49470/1 for specific maximum A dimension. For maximum B dimension, add 1.65 (0.065) to the appropriate A dimension. For all lead styles, the number of chips is determined by the capacitance and voltage rating.
- For case code 5, dimensions shall be 2.54 (0.100) maximum and 0.305 (0.012) minimum.
- Lead alignment within pin rows shall be within ±0.10 (0.005).



SMPS Stacked MLC Capacitors



(SM Style) SM Military Styles MIL-PRF-49470/2

MIL-PRF-49470/2

MIL-PRF-49470/2 - capacitor, fixed, ceramic dielectric, switch mode power supply (general purpose and temperature stable), standard reliability and high reliability encapsulated, Style PS02.

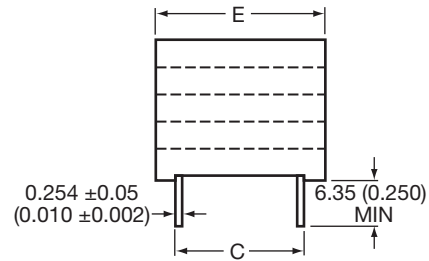
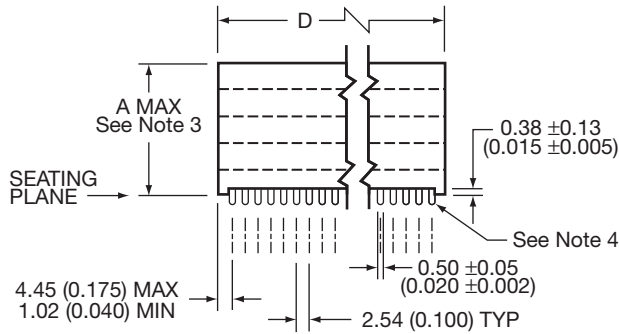

LEAD STYLE N AND A

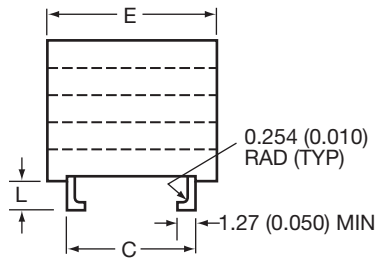

LEAD STYLE J AND C

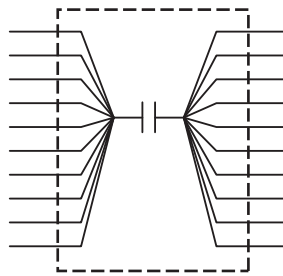

CIRCUIT DIAGRAM

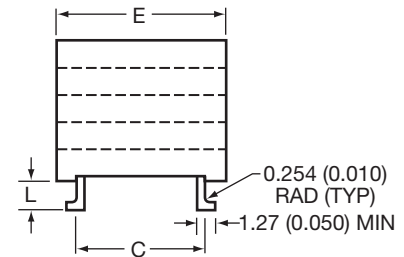

LEAD STYLE L AND B

DIMENSIONS:

millimeters (inches)

Case Code	C ±0.635 (±0.025)	D ±0.635 (±0.025)	E (max)	Number of Leads per side
1	11.4 (0.450)	54.7 (2.155)	14.7 (0.580)	20
2	20.3 (0.800)	41.0 (1.615)	24.1 (0.950)	15
3	11.4 (0.450)	29.3 (1.155)	14.7 (0.580)	10
4	10.2 (0.400)	12.3 (0.485)	12.3 (0.485)	4
5	6.35 (0.250)	9.02 (0.355)	9.02 (0.355)	3
6	31.8 (1.250)	54.7 (2.155)	36.3 (1.430)	20

NOTES:

1. Dimensions are in millimeters (inches)
2. Unless otherwise specified, tolerances are 0.254 (±0.001).
3. See table I of MIL-PRF-49470/2 for specific maximum A dimension. For all lead styles, the number of chips is determined by the capacitance and voltage rating.
4. Lead alignment within pin rows shall be within ±0.10 (0.004).



SMPS Stacked MLC Capacitors



(SM Style) SM Military Styles MIL-PRF-49470

MIL-PRF-49470 PIN 1/	AVX PART NUMBER (for reference only) 2/	Capacitance µF	Tolerance	Characteristic	Case Code	Lead Configuration
25V						
-49470X0-155-Z-	SM-53C155-H-270	1.5	K, M	BX	5	N, L, M, J, K
-49470X0-185-Z-	SM-53C185-H-270	1.8	K, M	BX	5	N, L, M, J, K
-49470X0-225-Z-	SM-53C225-H-270	2.2	K, M	BX	5	N, L, M, J, K
-49470X0-275-Z-	SM-53C275-H-390	2.7	K, M	BX	5	N, L, M, J, K
-49470X0-335-Z-	SM-53C335-H-390	3.3	K, M	BX	5	N, L, M, J, K
-49470X0-395-Z-	SM-53C395-H-390	3.9	K, M	BX	5	N, L, M, J, K
-49470X0-475-Z-	SM-53C475-H-390	4.7	K, M	BX	5	N, L, M, J, K
-49470X0-565-Z-	SM-53C565-H-530	5.6	K, M	BX	5	N, L, M, J, K
-49470X0-685-Z-	SM-53C685-H-530	6.8	K, M	BX	5	N, L, M, J, K
-49470X0-685-Z-	SM-43C685-H-270	6.8	K, M	BX	4	A, B, D, C, F
-49470X0-825-Z-	SM-53C825-H-660	8.2	K, M	BX	5	N, L, M, J, K
-49470X0-825-Z-	SM-43C825-H-390	8.2	K, M	BX	4	A, B, D, C, F
-49470X0-106-Z-	SM-53C106-H-800	10	K, M	BX	5	N, L, M, J, K
-49470X0-106-Z-	SM-43C106-H-390	10	K, M	BX	4	A, B, D, C, F
-49470X0-126-Z-	SM-43C126-H-390	12	K, M	BX	4	N, L, M, J, K
-49470X0-156-Z-	SM-43C156-H-530	15	K, M	BX	4	N, L, M, J, K
-49470X0-156-Z-	SM-33C156-H-270	15	K, M	BX	3	A, B, D, C, F
-49470X0-186-Z-	SM-43C186-H-530	18	K, M	BX	4	N, L, M, J, K
-49470X0-186-Z-	SM-33C186-H-270	18	K, M	BX	3	A, B, D, C, F
-49470X0-226-Z-	SM-43C226-H-660	22	K, M	BX	4	N, L, M, J, K
-49470X0-226-Z-	SM-33C226-H-390	22	K, M	BX	3	A, B, D, C, F
-49470X0-276-Z-	SM-43C276-H-660	27	K, M	BX	4	N, L, M, J, K
-49470X0-276-Z-	SM-33C276-H-390	27	K, M	BX	3	A, B, D, C, F
-49470X0-336-Z-	SM-43C336-H-800	33	K, M	BX	4	N, L, M, J, K
-49470X0-336-Z-	SM-33C336-H-390	33	K, M	BX	3	A, B, D, C, F
-49470X0-396-Z-	SM-33C396-H-530	39	K, M	BX	3	N, L, M, J, K
-49470X0-396-Z-	SM-13C396-H-390	39	K, M	BX	1	A, B, D, C, F
-49470X0-476-Z-	SM-33C476-H-660	47	K, M	BX	3	N, L, M, J, K
-49470X0-476-Z-	SM-13C476-H-530	47	K, M	BX	1	A, B, D, C, F
-49470X0-566-Z-	SM-33C566-H-660	56	K, M	BX	3	N, L, M, J, K
-49470X0-566-Z-	SM-13C566-H-530	56	K, M	BX	1	A, B, D, C, F
-49470X0-686-Z-	SM-33C686-H-660	68	K, M	BX	3	N, L, M, J, K
-49470X0-686-Z-	SM-13C686-H-530	68	K, M	BX	1	A, B, D, C, F
-49470X0-826-Z-	SM-33C826-H-800	82	K, M	BX	3	N, L, M, J, K
-49470X0-826-Z-	SM-13C826-H-530	82	K, M	BX	1	A, B, D, C, F
-49470X0-107-Z-	SM-13C107-H-660	100	K, M	BX	1	N, L, M, J, K
-49470X0-107-Z-	SM-23C107-H-530	100	K, M	BX	2	A, B, D, C, F
-49470X0-127-Z-	SM-13C127-H-800	120	K, M	BX	1	N, L, M, J, K
-49470X0-127-Z-	SM-23C127-H-530	120	K, M	BX	2	A, B, D, C, F
-49470X0-157-Z-	SM-23C157-H-660	150	K, M	BX	2	N, L, M, J, K
-49470X0-157-Z-	SM-63C157-H-390	150	K, M	BX	6	A, B, D, C, F
-49470X0-187-Z-	SM-23C187-H-800	180	K, M	BX	2	N, L, M, J, K
-49470X0-187-Z-	SM-63C187-H-530	180	K, M	BX	6	A, B, D, C, F
-49470X0-227-Z-	SM-63C227-H-530	220	K, M	BX	6	N, L, M, J, K
-49470X0-277-Z-	SM-63C277-H-660	270	K, M	BX	6	N, L, M, J, K
-49470X0-337-Z-	SM-63C337-H-800	330	K, M	BX	6	N, L, M, J, K
-49470X0-397-Z-	SM-63C397-H-800	390	K, M	BX	6	N, L, M, J, K
50V						
-49470X0-105-A-	SM-55C105-H-120	1	K, M	BX	5	N, L, M, J, K
-49470X0-125-A-	SM-55C125-H-120	1.2	K, M	BX	5	N, L, M, J, K
-49470X0-155-A-	SM-55C155-H-240	1.5	K, M	BX	5	N, L, M, J, K
-49470X0-185-A-	SM-55C185-H-240	1.8	K, M	BX	5	N, L, M, J, K
-49470X0-225-A-	SM-55C225-H-240	2.2	K, M	BX	5	N, L, M, J, K
-49470X0-275-A-	SM-55C275-H-360	2.7	K, M	BX	5	N, L, M, J, K
-49470X0-335-A-	SM-55C335-H-360	3.3	K, M	BX	5	N, L, M, J, K
-49470X0-395-A-	SM-55C395-H-480	3.9	K, M	BX	5	N, L, M, J, K

1/ Complete PIN shall include additional symbols replacing dashes (from left to right): product level (M for B level, or T for T level), part style (1 for unencapsulated, 2 for encapsulated), capacitance tolerance, lead configuration

2/ Complete AVX Part Number (provided for reference only) shall include additional symbols replacing dashes (from left to right): part style (0 for unencapsulated and 9 for encapsulated), capacitance tolerance, lead configuration



SMPS Stacked MLC Capacitors



(SM Style) SM Military Styles MIL-PRF-49470

MIL-PRF-49470 PIN 1/	AVX PART NUMBER (for reference only) 2/	Capacitance µF	Tolerance	Characteristic	Case Code	Lead Configuration
-49470X0-475-A-	SM-55C475-H-480	4.7	K, M	BX	5	N, L, M, J, K
-49470X0-475-A-	SM-45C475-H-240	4.7	K, M	BX	4	A, B, D, C, F
-49470X0-565-A-	SM-55C565-H-650	5.6	K, M	BX	5	N, L, M, J, K
-49470X0-565-A-	SM-45C565-H-240	5.6	K, M	BX	4	A, B, D, C, F
-49470X0-685-A-	SM-45C685-H-360	6.8	K, M	BX	4	N, L, M, J, K
-49470X0-825-A-	SM-45C825-H-360	8.2	K, M	BX	4	N, L, M, J, K
-49470X0-106-A-	SM-45C106-H-480	10	K, M	BX	4	N, L, M, J, K
-49470X0-126-A-	SM-45C126-H-480	12	K, M	BX	4	N, L, M, J, K
-49470X0-156-A-	SM-45C156-H-650	15	K, M	BX	4	N, L, M, J, K
-49470X0-156-A-	SM-35C156-H-240	15	K, M	BX	3	A, B, D, C, F
-49470X0-186-A-	SM-35C186-H-240	18	K, M	BX	3	N, L, M, J, K
-49470X0-226-A-	SM-35C226-H-360	22	K, M	BX	3	N, L, M, J, K
-49470X0-276-A-	SM-35C276-H-360	27	K, M	BX	3	N, L, M, J, K
-49470X0-336-A-	SM-35C336-H-360	33	K, M	BX	3	N, L, M, J, K
-49470X0-396-A-	SM-35C396-H-480	39	K, M	BX	3	N, L, M, J, K
-49470X0-476-A-	SM-35C476-H-650	47	K, M	BX	3	N, L, M, J, K
-49470X0-476-A-	SM-25C476-H-240	47	K, M	BX	2	A, B, D, C, F
-49470X0-566-A-	SM-15C566-H-360	56	K, M	BX	1	N, L, M, J, K
-49470X0-566-A-	SM-25C566-H-240	56	K, M	BX	2	A, B, D, C, F
-49470X0-686-A-	SM-15C686-H-480	68	K, M	BX	1	N, L, M, J, K
-49470X0-686-A-	SM-25C686-H-360	68	K, M	BX	2	A, B, D, C, F
-49470X0-826-A-	SM-15C826-H-480	82	K, M	BX	1	N, L, M, J, K
-49470X0-826-A-	SM-25C826-H-360	82	K, M	BX	2	A, B, D, C, F
-49470X0-107-A-	SM-15C107-H-650	100	K, M	BX	1	N, L, M, J, K
-49470X0-107-A-	SM-25C107-H-480	100	K, M	BX	2	A, B, D, C, F
-49470X0-127-A-	SM-25C127-H-480	120	K, M	BX	2	N, L, M, J, K
-49470X0-157-A-	SM-25C157-H-650	150	K, M	BX	2	N, L, M, J, K
-49470X0-187-A-	SM-65C187-H-480	180	K, M	BX	6	N, L, M, J, K
-49470X0-227-A-	SM-65C227-H-480	220	K, M	BX	6	N, L, M, J, K
-49470X0-277-A-	SM-65C277-H-650	270	K, M	BX	6	N, L, M, J, K
100V						
-49470X0-684-B-	SM-51C684-H-120	0.68	K, M	BX	5	N, L, M, J, K
-49470X0-824-B-	SM-51C824-H-240	0.82	K, M	BX	5	N, L, M, J, K
-49470X0-105-B-	SM-51C105-H-240	1	K, M	BX	5	N, L, M, J, K
-49470X0-125-B-	SM-51C125-H-240	1.2	K, M	BX	5	N, L, M, J, K
-49470X0-155-B-	SM-51C155-H-360	1.5	K, M	BX	5	N, L, M, J, K
-49470X0-185-B-	SM-51C185-H-360	1.8	K, M	BX	5	N, L, M, J, K
-49470X0-225-B-	SM-51C225-H-480	2.2	K, M	BX	5	N, L, M, J, K
-49470X0-225-B-	SM-41C225-H-240	2.2	K, M	BX	4	A, B, D, C, F
-49470X0-275-B-	SM-51C275-H-480	2.7	K, M	BX	5	N, L, M, J, K
-49470X0-335-B-	SM-51C335-H-650	3.3	K, M	BX	5	N, L, M, J, K
-49470X0-335-B-	SM-41C335-H-240	3.3	K, M	BX	4	A, B, D, C, F
-49470X0-395-B-	SM-41C395-H-360	3.9	K, M	BX	4	N, L, M, J, K
-49470X0-475-B-	SM-41C475-H-360	4.7	K, M	BX	4	N, L, M, J, K
-49470X0-565-B-	SM-41C565-H-480	5.6	K, M	BX	4	N, L, M, J, K
-49470X0-685-B-	SM-41C685-H-480	6.8	K, M	BX	4	N, L, M, J, K
-49470X0-825-B-	SM-41C825-H-650	8.2	K, M	BX	4	N, L, M, J, K
-49470X0-825-B-	SM-31C825-H-240	8.2	K, M	BX	3	A, B, D, C, F
-49470X0-106-B-	SM-31C106-H-240	10	K, M	BX	3	N, L, M, J, K
-49470X0-126-B-	SM-31C126-H-240	12	K, M	BX	3	N, L, M, J, K
-49470X0-156-B-	SM-31C156-H-360	15	K, M	BX	3	N, L, M, J, K
-49470X0-186-B-	SM-31C186-H-360	18	K, M	BX	3	N, L, M, J, K
-49470X0-226-B-	SM-31C226-H-480	22	K, M	BX	3	N, L, M, J, K
-49470X0-276-B-	SM-31C276-H-650	27	K, M	BX	3	N, L, M, J, K
-49470X0-276-B-	SM-21C276-H-240	27	K, M	BX	2	A, B, D, C, F
-49470X0-336-B-	SM-11C336-H-360	33	K, M	BX	1	N, L, M, J, K
-49470X0-336-B-	SM-21C336-H-240	33	K, M	BX	2	A, B, D, C, F

1/ Complete PIN shall include additional symbols replacing dashes (from left to right): product level (M for B level, or T for T level), part style (1 for unencapsulated, 2 for encapsulated), capacitance tolerance, lead configuration

2/ Complete AVX Part Number (provided for reference only) shall include additional symbols replacing dashes (from left to right): part style (0 for unencapsulated and 9 for encapsulated), capacitance tolerance, lead configuration

SMPS Stacked MLC Capacitors



(SM Style) SM Military Styles MIL-PRF-49470

MIL-PRF-49470 PIN 1/	AVX PART NUMBER (for reference only) 2/	Capacitance µF	Tolerance	Characteristic	Case Code	Lead Configuration
-49470X0-396-B-	SM-11C396-H-480	39	K, M	BX	1	N, L, M, J, K
-49470X0-396-B-	SM-21C396-H-360	39	K, M	BX	2	A, B, D, C, F
-49470X0-476-B-	SM-11C476-H-480	47	K, M	BX	1	N, L, M, J, K
-49470X0-476-B-	SM-21C476-H-360	47	K, M	BX	2	A, B, D, C, F
-49470X0-566-B-	SM-11C566-H-650	56	K, M	BX	1	N, L, M, J, K
-49470X0-686-B-	SM-21C686-H-480	68	K, M	BX	2	N, L, M, J, K
-49470X0-826-B-	SM-21C826-H-650	82	K, M	BX	2	N, L, M, J, K
-49470X0-107-B-	SM-21C107-H-360	100	K, M	BX	6	N, L, M, J, K
-49470X0-127-B-	SM-21C127-H-360	120	K, M	BX	6	N, L, M, J, K
-49470X0-157-B-	SM-21C157-H-480	150	K, M	BX	6	N, L, M, J, K
-49470X0-187-B-	SM-21C187-H-540	180	K, M	BX	6	N, L, M, J, K
200V						
-49470R0-474-C-	SM-52C474-H-240	0.47	K, M	BR	5	N, L, M, J, K
-49470R0-564-C-	SM-52C564-H-240	0.56	K, M	BR	5	N, L, M, J, K
-49470R0-684-C-	SM-52C684-H-360	0.68	K, M	BR	5	N, L, M, J, K
-49470R0-824-C-	SM-52C824-H-360	0.82	K, M	BR	5	N, L, M, J, K
-49470R0-105-C-	SM-52C105-H-480	1	K, M	BR	5	N, L, M, J, K
-49470R0-105-C-	SM-42C105-H-120	1	K, M	BR	4	A, B, D, C, F
-49470R0-125-C-	SM-52C125-H-480	1.2	K, M	BR	5	N, L, M, J, K
-49470R0-125-C-	SM-42C125-H-240	1.2	K, M	BR	4	A, B, D, C, F
-49470R0-155-C-	SM-52C155-H-650	1.5	K, M	BR	5	N, L, M, J, K
-49470R0-155-C-	SM-42C155-H-240	1.5	K, M	BR	4	A, B, D, C, F
-49470R0-185-C-	SM-42C185-H-360	1.8	K, M	BR	4	N, L, M, J, K
-49470R0-225-C-	SM-42C225-H-360	2.2	K, M	BR	4	N, L, M, J, K
-49470R0-275-C-	SM-42C275-H-480	2.7	K, M	BR	4	N, L, M, J, K
-49470R0-335-C-	SM-42C335-H-480	3.3	K, M	BR	4	N, L, M, J, K
-49470R0-395-C-	SM-42C395-H-650	3.9	K, M	BR	4	N, L, M, J, K
-49470R0-395-C-	SM-32C395-H-240	3.9	K, M	BR	3	A, B, D, C, F
-49470R0-475-C-	SM-32C475-H-240	4.7	K, M	BR	3	N, L, M, J, K
-49470R0-565-C-	SM-32C565-H-240	5.6	K, M	BR	3	N, L, M, J, K
-49470R0-685-C-	SM-32C685-H-360	6.8	K, M	BR	3	N, L, M, J, K
-49470R0-825-C-	SM-32C825-H-360	8.2	K, M	BR	3	N, L, M, J, K
-49470R0-106-C-	SM-32C106-H-480	10	K, M	BR	3	N, L, M, J, K
-49470R0-126-C-	SM-32C126-H-650	12	K, M	BR	3	N, L, M, J, K
-49470R0-126-C-	SM-22C126-H-240	12	K, M	BR	2	A, B, D, C, F
-49470R0-156-C-	SM-12C156-H-360	15	K, M	BR	1	N, L, M, J, K
-49470R0-156-C-	SM-22C156-H-240	15	K, M	BR	2	A, B, D, C, F
-49470R0-186-C-	SM-12C186-H-480	18	K, M	BR	1	N, L, M, J, K
-49470R0-186-C-	SM-22C186-H-360	18	K, M	BR	2	A, B, D, C, F
-49470R0-226-C-	SM-12C226-H-650	22	K, M	BR	1	N, L, M, J, K
-49470R0-226-C-	SM-22C226-H-360	22	K, M	BR	2	A, B, D, C, F
-49470R0-276-C-	SM-12C276-H-650	27	K, M	BR	1	N, L, M, J, K
-49470R0-276-C-	SM-22C276-H-480	27	K, M	BR	2	A, B, D, C, F
-49470R0-336-C-	SM-22C336-H-480	33	K, M	BR	2	N, L, M, J, K
-49470R0-396-C-	SM-22C396-H-650	39	K, M	BR	2	N, L, M, J, K
-49470R0-476-C-	SM-62C476-H-240	47	K, M	BR	6	N, L, M, J, K
-49470R0-566-C-	SM-62C566-H-360	56	K, M	BR	6	N, L, M, J, K
-49470R0-686-C-	SM-62C686-H-360	68	K, M	BR	6	N, L, M, J, K
-49470R0-826-C-	SM-62C826-H-480	82	K, M	BR	6	N, L, M, J, K
-49470R0-107-C-	SM-62C107-H-650	100	K, M	BR	6	N, L, M, J, K
-49470R0-127-C-	SM-62C127-H-650	120	K, M	BR	6	N, L, M, J, K
500V						
-49470Q0-154-E-	SM-57C154-H-120	0.15	K, M	BQ	5	N, L, M, J, K
-49470Q0-184-E-	SM-57C184-H-240	0.18	K, M	BQ	5	N, L, M, J, K
-49470Q0-224-E-	SM-57C224-H-240	0.22	K, M	BQ	5	N, L, M, J, K
-49470Q0-274-E-	SM-57C274-H-240	0.27	K, M	BQ	5	N, L, M, J, K
-49470Q0-334-E-	SM-57C334-H-360	0.33	K, M	BQ	5	N, L, M, J, K

1/ Complete PIN shall include additional symbols replacing dashes (from left to right): product level (M for B level, or T for T level), part style (1 for unencapsulated, 2 for encapsulated), capacitance tolerance, lead configuration

2/ Complete AVX Part Number (provided for reference only) shall include additional symbols replacing dashes (from left to right): part style (0 for unencapsulated and 9 for encapsulated), capacitance tolerance, lead configuration

SMPS Stacked MLC Capacitors



(SM Style) SM Military Styles MIL-PRF-49470

MIL-PRF-49470 PIN 1/	AVX PART NUMBER (for reference only) 2/	Capacitance µF	Tolerance	Characteristic	Case Code	Lead Configuration
-49470Q0-394-E-	SM-57C394-H-360	0.39	K, M	BQ	5	N, L, M, J, K
-49470Q0-474-E-	SM-57C474-H-360	0.47	K, M	BQ	5	N, L, M, J, K
-49470Q0-564-E-	SM-57C564-H-480	0.56	K, M	BQ	5	N, L, M, J, K
-49470Q0-564-E-	SM-47C564-H-240	0.56	K, M	BQ	4	A, B, D, C, F
-49470Q0-684-E-	SM-57C684-H-650	0.68	K, M	BQ	5	N, L, M, J, K
-49470Q0-684-E-	SM-47C684-H-240	0.68	K, M	BQ	4	A, B, D, C, F
-49470Q0-824-E-	SM-47C824-H-360	0.82	K, M	BQ	4	N, L, M, J, K
-49470Q0-105-E-	SM-47C105-H-360	1	K, M	BQ	4	N, L, M, J, K
-49470Q0-125-E-	SM-47C125-H-360	1.2	K, M	BQ	4	N, L, M, J, K
-49470Q0-155-E-	SM-47C155-H-480	1.5	K, M	BQ	4	N, L, M, J, K
-49470Q0-185-E-	SM-47C185-H-650	1.8	K, M	BQ	4	N, L, M, J, K
-49470Q0-185-E-	SM-37C185-H-240	1.8	K, M	BQ	3	A, B, D, C, F
-49470Q0-225-E-	SM-37C225-H-240	2.2	K, M	BQ	3	N, L, M, J, K
-49470Q0-275-E-	SM-37C275-H-360	2.7	K, M	BQ	3	N, L, M, J, K
-49470Q0-335-E-	SM-37C335-H-360	3.3	K, M	BQ	3	N, L, M, J, K
-49470Q0-395-E-	SM-37C395-H-360	3.9	K, M	BQ	3	N, L, M, J, K
-49470Q0-475-E-	SM-37C475-H-480	4.7	K, M	BQ	3	N, L, M, J, K
-49470Q0-565-E-	SM-37C565-H-650	5.6	K, M	BQ	3	N, L, M, J, K
-49470Q0-565-E-	SM-27C565-H-240	5.6	K, M	BQ	2	A, B, D, C, F
-49470Q0-685-E-	SM-17C685-H-480	6.8	K, M	BQ	1	N, L, M, J, K
-49470Q0-685-E-	SM-27C685-H-240	6.8	K, M	BQ	2	A, B, D, C, F
-49470Q0-825-E-	SM-17C825-H-480	8.2	K, M	BQ	1	N, L, M, J, K
-49470Q0-825-E-	SM-27C825-H-360	8.2	K, M	BQ	2	A, B, D, C, F
-49470Q0-106-E-	SM-17C106-H-480	10	K, M	BQ	1	N, L, M, J, K
-49470Q0-106-E-	SM-27C106-H-360	10	K, M	BQ	2	A, B, D, C, F
-49470Q0-126-E-	SM-17C126-H-650	12	K, M	BQ	1	N, L, M, J, K
-49470Q0-126-E-	SM-27C126-H-480	12	K, M	BQ	2	A, B, D, C, F
-49470Q0-156-E-	SM-27C156-H-650	15	K, M	BQ	2	N, L, M, J, K
-49470Q0-186-E-	SM-27C186-H-650	18	K, M	BQ	2	N, L, M, J, K
-49470Q0-226-E-	SM-67C226-H-360	22	K, M	BQ	6	N, L, M, J, K
-49470Q0-276-E-	SM-67C276-H-360	27	K, M	BQ	6	N, L, M, J, K
-49470Q0-336-E-	SM-67C336-H-480	33	K, M	BQ	6	N, L, M, J, K
-49470Q0-396-E-	SM-67C396-H-650	39	K, M	BQ	6	N, L, M, J, K
-49470P0-103-E-	SM-57A103-H-120	0.01	J, K	BP	5	N, L, M, J, K
-49470P0-123-E-	SM-57A123-H-240	0.012	J, K	BP	5	N, L, M, J, K
-49470P0-153-E-	SM-57A153-H-240	0.015	J, K	BP	5	N, L, M, J, K
-49470P0-183-E-	SM-57A183-H-240	0.018	J, K	BP	5	N, L, M, J, K
-49470P0-223-E-	SM-57A223-H-360	0.022	J, K	BP	5	N, L, M, J, K
-49470P0-273-E-	SM-57A273-H-360	0.027	J, K	BP	5	N, L, M, J, K
-49470P0-333-E-	SM-57A333-H-480	0.033	J, K	BP	5	N, L, M, J, K
-49470P0-333-E-	SM-57A333-H-240	0.033	J, K	BP	4	A, B, C, D, F
-49470P0-393-E-	SM-47A393-H-480	0.039	J, K	BP	5	N, L, M, J, K
-49470P0-393-E-	SM-57A393-H-240	0.039	J, K	BP	4	A, B, C, D, F
-49470P0-473-E-	SM-47A473-H-650	0.047	J, K	BP	5	N, L, M, J, K
-49470P0-473-E-	SM-47A473-H-360	0.047	J, K	BP	4	A, B, C, D, F
-49470P0-563-E-	SM-47A563-H-360	0.056	J, K	BP	4	N, L, M, J, K
-49470P0-683-E-	SM-47A683-H-360	0.068	J, K	BP	4	N, L, M, J, K
-49470P0-823-E-	SM-47A823-H-480	0.082	J, K	BP	4	N, L, M, J, K
-49470P0-104-E-	SM-47A104-H-480	0.1	J, K	BP	4	N, L, M, J, K
-49470P0-124-E-	SM-37A124-H-650	0.12	J, K	BP	4	N, L, M, J, K
-49470P0-124-E-	SM-37A124-H-240	0.12	J, K	BP	3	A, B, C, D, F
-49470P0-154-E-	SM-37A154-H-240	0.15	J, K	BP	3	N, L, M, J, K
-49470P0-184-E-	SM-37A184-H-240	0.18	J, K	BP	3	N, L, M, J, K
-49470P0-224-E-	SM-37A224-H-360	0.22	J, K	BP	3	N, L, M, J, K
-49470P0-274-E-	SM-37A274-H-360	0.27	J, K	BP	3	N, L, M, J, K
-49470P0-334-E-	SM-37A334-H-480	0.33	J, K	BP	3	N, L, M, J, K
-49470P0-394-E-	SM-27A394-H-650	0.39	J, K	BP	3	N, L, M, J, K

1/ Complete PIN shall include additional symbols replacing dashes (from left to right): product level (M for B level, or T for T level), part style (1 for unencapsulated, 2 for encapsulated), capacitance tolerance, lead configuration

2/ Complete AVX Part Number (provided for reference only) shall include additional symbols replacing dashes (from left to right): part style (0 for unencapsulated and 9 for encapsulated), capacitance tolerance, lead configuration

SMPS Stacked MLC Capacitors



(SM Style) SM Military Styles MIL-PRF-49470

MIL-PRF-49470 PIN 1/	AVX PART NUMBER (for reference only) 2/	Capacitance μF	Tolerance	Characteristic	Case Code	Lead Configuration
-49470P0-394-E-	SM-17A394-H-240	0.39	J, K	BP	2	A, B, C, D, F
-49470P0-474-E-	SM-27A474-H-360	0.47	J, K	BP	1	N, L, M, J, K
-49470P0-474-E-	SM-17A474-H-240	0.47	J, K	BP	2	A, B, C, D, F
-49470P0-564-E-	SM-27A564-H-480	0.56	J, K	BP	1	N, L, M, J, K
-49470P0-564-E-	SM-17A564-H-360	0.56	J, K	BP	2	A, B, C, D, F
-49470P0-684-E-	SM-27A684-H-480	0.68	J, K	BP	1	N, L, M, J, K
-49470P0-684-E-	SM-17A684-H-360	0.68	J, K	BP	2	A, B, C, D, F
-49470P0-824-E-	SM-27A824-H-650	0.82	J, K	BP	1	N, L, M, J, K
-49470P0-824-E-	SM-27A824-H-480	0.82	J, K	BP	2	A, B, C, D, F
-49470P0-105-E-	SM-27A105-H-480	1	J, K	BP	2	N, L, M, J, K
-49470P0-125-E-	SM-67A125-H-650	1.2	J, K	BP	2	N, L, M, J, K
-49470P0-155-E-	SM-67A155-H-360	1.5	J, K	BP	6	N, L, M, J, K
-49470P0-185-E-	SM-67A185-H-480	1.8	J, K	BP	6	N, L, M, J, K
-49470P0-225-E-	SM-67A225-H-650	2.2	J, K	BP	6	N, L, M, J, K

1/ Complete PIN shall include additional symbols replacing dashes (from left to right): product level (M for B level, or T for T level), part style (1 for unencapsulated, 2 for encapsulated), capacitance tolerance, lead configuration

2/ Complete AVX Part Number (provided for reference only) shall include additional symbols replacing dashes (from left to right): part style (0 for unencapsulated and 9 for encapsulated), capacitance tolerance, lead configuration

SMPS Stacked MLC Capacitors



(SM Style) SM Military Styles DSCC Dwg. #87106 & #88011

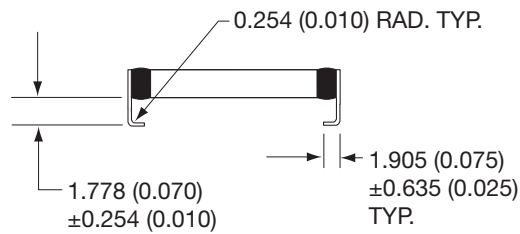
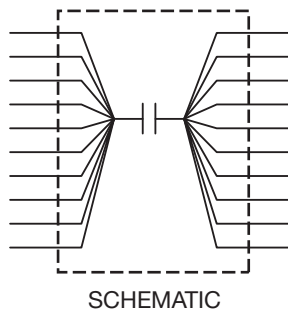
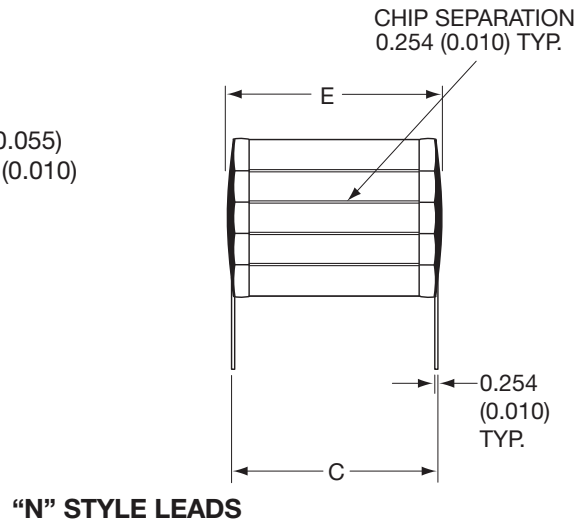
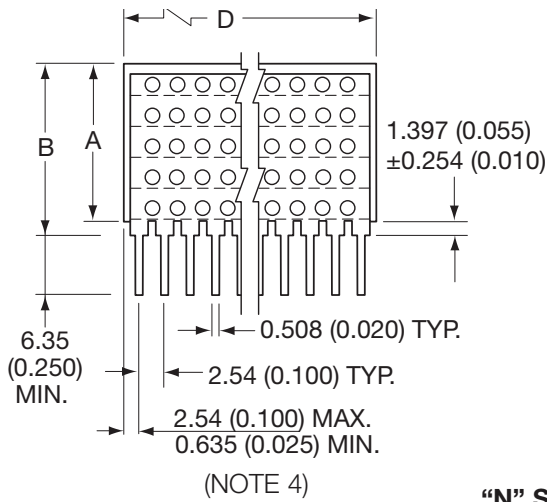

DIMENSIONS

millimeters (inches)

Case Code	A (max.) (See Note 2)	B (max.) (See Note 2)	C ±.635 (±0.025)	D ±.635 (±0.025)	E (max.)	No. of Leads per side
1	16.5 (0.650)	18.2 (0.715)	11.4 (0.450)	52.1 (2.050)	12.7 (0.500)	20
2	16.5 (0.650)	18.2 (0.715)	20.3 (0.800)	38.4 (1.510)	22.1 (0.870)	15
3	16.5 (0.650)	18.2 (0.715)	11.4 (0.450)	26.7 (1.050)	12.7 (0.500)	10
4	16.5 (0.650)	18.2 (0.715)	10.2 (0.400)	10.2 (0.400)	11.2 (0.440)	4
5	16.5 (0.650)	18.2 (0.715)	6.35 (0.250)	6.35 (0.250)	7.62 (0.300)	3
6	16.5 (0.650)	18.2 (0.715)	31.8 (1.250)	52.1 (2.050)	34.3 (1.350)	20

NOTES:

1. Unless otherwise specified, tolerances 0.254 (±0.010).
2. “A” dimensions are maximum (see tables on pages 23 thru 26 for specific part number dimensions).
3. “N” straight leads; “J” leads formed in.
4. For case code 5, dimensions shall be 2.54 (0.100) maximum, 0.305 (0.012) minimum.



SMPS Stacked MLC Capacitors



(SM Style) DSCC #87106 and #88011

Table II. Group A inspection.

Inspection	Requirement paragraph of MIL-PRF-49470	Test method paragraph of MIL-PRF-49470	Sampling procedure
Subgroup 1 Thermal shock and voltage conditioning <u>1/</u>	3.9	4.8.5	100% inspection
Subgroup 2 Visual and mechanical examination: Material Physical dimensions Interface requirements (other than physical dimensions) Marking <u>2/</u> Workmanship	3.4 3.1 3.5 and 3.5.1 3.28 3.30	4.8.4	13 samples 0 failures

1/ Post checks are required (see paragraph 3.9 of MIL-PRF-49470).

2/ Marking defects are based on visual examination only. Any subsequent electrical defects shall not be used as a basis for determining marking defects.

Table III. Group B inspection. 1/

Inspection	Requirement paragraph of MIL-PRF-49470	Test method paragraph of MIL-PRF-49470	Number of sample units to be inspected	Number of defectives permitted <u>2/</u>	
Subgroup 1 <u>3/</u> Temperature coefficient Resistance to solvents <u>5/</u> <u>6/</u> Immersion Terminal strength <u>5/</u>	<u>4/</u> 3.23 3.18 3.24	<u>4/</u> 4.8.20 4.8.15 4.8.10	12	1	<u>6/</u> 1
Subgroup 2 Resistance to soldering heat Moisture resistance	3.20 3.21	4.8.17 4.8.18	12	1	
Subgroup 3 Marking legibility (laser marking only)	3.28.1	4.8.4.1	6	1	
Subgroup 4 Solderability	3.15	4.8.12	3	0	
Subgroup 5 Life	3.26	4.8.22	5 minimum per case code	0	

1/ Unless otherwise specified herein, when necessary, mounting of group B samples shall be at the discretion of the manufacturer.

2/ A sample unit having one or more defects shall be charged as a single defective.

3/ Order of tests is at discretion of manufacturer.

4/ See 3.2.3 of DSCC 87106.

5/ Sample size shall be 3 pieces with zero defectives permitted.

6/ Total of one defect allowed for combination of subgroup 1, subgroup 2, and subgroup 3 inspections.

SMPS Stacked MLC Capacitors



(SM Style) SM Military Styles DSCC Dwg. #87106 (X7R)

Electrical characteristics

DSCC Dwg. 87106-	Cap. Value (µF)	Cap. Tol.	Case Code	Lead Style	Max. A Dimension mm (inches)
50V					
001	1.0	K	5	N	3.05 (0.120)
002	1.0	M	5	N	3.05 (0.120)
241	1.0	K	5	J	3.05 (0.120)
242	1.0	M	5	J	3.05 (0.120)
003	1.2	K	5	N	3.05 (0.120)
004	1.2	M	5	N	3.05 (0.120)
243	1.2	K	5	J	3.05 (0.120)
244	1.2	M	5	J	3.05 (0.120)
005	1.5	K	5	N	6.10 (0.240)
006	1.5	M	5	N	6.10 (0.240)
245	1.5	K	5	J	6.10 (0.240)
246	1.5	M	5	J	6.10 (0.240)
007	1.8	K	5	N	6.10 (0.240)
008	1.8	M	5	N	6.10 (0.240)
247	1.8	K	5	J	6.10 (0.240)
248	1.8	M	5	J	6.10 (0.240)
009	2.2	K	5	N	6.10 (0.240)
010	2.2	M	5	N	6.10 (0.240)
249	2.2	K	5	J	6.10 (0.240)
250	2.2	M	5	J	6.10 (0.240)
011	2.7	K	5	N	9.14 (0.360)
012	2.7	M	5	N	9.14 (0.360)
251	2.7	K	5	J	9.14 (0.360)
252	2.7	M	5	J	9.14 (0.360)
013	3.3	K	5	N	9.14 (0.360)
014	3.3	M	5	N	9.14 (0.360)
253	3.3	K	5	J	9.14 (0.360)
254	3.3	M	5	J	9.14 (0.360)
015	3.9	K	5	N	12.2 (0.480)
016	3.9	M	5	N	12.2 (0.480)
255	3.9	K	5	J	12.2 (0.480)
256	3.9	M	5	J	12.2 (0.480)
017	4.7	K	5	N	12.2 (0.480)
018	4.7	M	5	N	12.2 (0.480)
257	4.7	K	5	J	12.2 (0.480)
258	4.7	M	5	J	12.2 (0.480)
019	5.6	K	5	N	16.5 (0.650)
020	5.6	M	5	N	16.5 (0.650)
259	5.6	K	5	J	16.5 (0.650)
260	5.6	M	5	J	16.5 (0.650)
223	6.8	K	4	N	9.14 (0.360)
224	6.8	M	4	N	9.14 (0.360)
261	6.8	K	4	J	9.14 (0.360)
262	6.8	M	4	J	9.14 (0.360)
021	8.2	K	4	N	9.14 (0.360)
022	8.2	M	4	N	9.14 (0.360)
263	8.2	K	4	J	9.14 (0.360)
264	8.2	M	4	J	9.14 (0.360)
023	10	K	4	N	12.2 (0.480)
024	10	M	4	N	12.2 (0.480)
265	10	K	4	J	12.2 (0.480)
266	10	M	4	J	12.2 (0.480)
025	12	K	4	N	12.2 (0.480)
026	12	M	4	N	12.2 (0.480)
267	12	K	4	J	12.2 (0.480)
268	12	M	4	J	12.2 (0.480)
027	15	K	4	N	16.5 (0.650)
028	15	M	4	N	16.5 (0.650)
269	15	K	4	J	16.5 (0.650)
270	15	M	4	J	16.5 (0.650)
029	18	K	3	N	6.10 (0.240)
030	18	M	3	N	6.10 (0.240)
271	18	K	3	J	6.10 (0.240)

DSCC Dwg. 87106-	Cap. Value (µF)	Cap. Tol.	Case Code	Lead Style	Max. A Dimension mm (inches)
50V					
272	18	M	3	J	6.10 (0.240)
272	18	M	3	J	6.10 (0.240)
031	22	K	3	N	9.14 (0.360)
032	22	M	3	N	9.14 (0.360)
273	22	K	3	J	9.14 (0.360)
274	22	M	3	J	9.14 (0.360)
033	27	K	3	N	9.14 (0.360)
034	27	M	3	N	9.14 (0.360)
275	27	K	3	J	9.14 (0.360)
276	27	M	3	J	9.14 (0.360)
035	33	K	3	N	9.14 (0.360)
036	33	M	3	N	9.14 (0.360)
277	33	K	3	J	9.14 (0.360)
278	33	M	3	J	9.14 (0.360)
037	39	K	3	N	12.2 (0.480)
038	39	M	3	N	12.2 (0.480)
279	39	K	3	J	12.2 (0.480)
280	39	M	3	J	12.2 (0.480)
039	47	K	3	N	16.5 (0.650)
040	47	M	3	N	16.5 (0.650)
281	47	K	3	J	16.5 (0.650)
282	47	M	3	J	16.5 (0.650)
225	56	K	1	N	9.14 (0.360)
226	56	M	1	N	9.14 (0.360)
283	56	K	1	J	9.14 (0.360)
284	56	M	1	J	9.14 (0.360)
041	68	K	1	N	12.2 (0.480)
042	68	M	1	N	12.2 (0.480)
285	68	K	1	J	12.2 (0.480)
286	68	M	1	J	12.2 (0.480)
043	82	K	1	N	12.2 (0.480)
044	82	M	1	N	12.2 (0.480)
287	82	K	1	J	12.2 (0.480)
288	82	M	1	J	12.2 (0.480)
045	100	K	1	N	16.5 (0.650)
046	100	M	1	N	16.5 (0.650)
289	100	K	1	J	16.5 (0.650)
290	100	M	1	J	16.5 (0.650)
227	120	K	2	N	12.2 (0.480)
228	120	M	2	N	12.2 (0.480)
291	120	K	2	J	12.2 (0.480)
292	120	M	2	J	12.2 (0.480)
047	150	K	2	N	16.5 (0.650)
048	150	M	2	N	16.5 (0.650)
293	150	K	2	J	16.5 (0.650)
294	150	M	2	J	16.5 (0.650)
049	180	K	6	N	12.2 (0.480)
050	180	M	6	N	12.2 (0.480)
295	180	K	6	J	12.2 (0.480)
296	180	M	6	J	12.2 (0.480)
051	220	K	6	N	12.2 (0.480)
052	220	M	6	N	12.2 (0.480)
297	220	K	6	J	12.2 (0.480)
298	220	M	6	J	12.2 (0.480)
053	270	K	6	N	16.5 (0.650)
054	270	M	6	N	16.5 (0.650)
299	270	K	6	J	16.5 (0.650)
300	270	M	6	J	16.5 (0.650)

DSCC Dwg. 87106-	Cap. Value (µF)	Cap. Tol.	Case Code	Lead Style	Max. A Dimension mm (inches)
100V					
055	.68	K	5	N	3.05 (0.120)
056	.68	M	5	N	3.05 (0.120)
301	.68	K	5	J	3.05 (0.120)
302	.68	M	5	J	3.05 (0.120)
057	.82	K	5	N	6.10 (0.240)
058	.82	M	5	N	6.10 (0.240)
303	.82	K	5	J	6.10 (0.240)
304	.82	M	5	J	6.10 (0.240)
059	1.0	K	5	N	6.10 (0.240)
060	1.0	M	5	N	6.10 (0.240)
305	1.0	K	5	J	6.10 (0.240)
306	1.0	M	5	J	6.10 (0.240)
061	1.2	K	5	N	6.10 (0.240)
062	1.2	M	5	N	6.10 (0.240)
307	1.2	K	5	J	6.10 (0.240)
308	1.2	M	5	J	6.10 (0.240)
063	1.5	K	5	N	9.14 (0.360)
064	1.5	M	5	N	9.14 (0.360)
309	1.5	K	5	J	9.14 (0.360)
310	1.5	M	5	J	9.14 (0.360)
065	1.8	K	5	N	9.14 (0.360)
066	1.8	M	5	N	9.14 (0.360)
311	1.8	K	5	J	9.14 (0.360)
312	1.8	M	5	J	9.14 (0.360)
067	2.2	K	5	N	12.2 (0.480)
068	2.2	M	5	N	12.2 (0.480)
313	2.2	K	5	J	12.2 (0.480)
314	2.2	M	5	J	12.2 (0.480)
069	2.7	K	5	N	12.2 (0.480)
070	2.7	M	5	N	12.2 (0.480)
315	2.7	K	5	J	12.2 (0.480)
316	2.7	M	5	J	12.2 (0.480)
071	3.3	K	5	N	16.5 (0.650)
072	3.3	M	5	N	16.5 (0.650)
317	3.3	K	5	J	16.5 (0.650)
318	3.3	M	5	J	16.5 (0.650)
073	3.9	K	4	N	9.14 (0.360)
074	3.9	M	4	N	9.14 (0.360)
319	3.9	K	4	J	9.14 (0.360)
320	3.9	M	4	J	9.14 (0.360)
075	4.7	K	4	N	9.14 (0.360)
076	4.7	M	4	N	9.14 (0.360)
321	4.7	K	4	J	9.14 (0.360)
322	4.7	M	4	J	9.14 (0.360)
077	5.6	K	4	N	12.2 (0.480)
078	5.6	M	4	N	12.2 (0.480)
323	5.6	K	4	J	12.2 (0.480)
324	5.6	M	4	J	12.2 (0.480)
079	6.8	K	4	N	12.2 (0.480)
080	6.8	M	4	N	12.2 (0.480)
325	6.8	K	4	J	12.2 (0.480)
326	6.8	M	4	J	12.2 (0.480)
081	8.2	K	4	N	16.5 (0.650)
082	8.2	M	4	N	16.5 (0.650)
327	8.2	K	4	J	16.5 (0.650)
328	8.2	M	4	J	16.5 (0.650)
229	10	K	3	N	6.10 (0.240)
230	10	M	3	N	6.10 (0.240)
329	10	K	3	J	6.10 (0.240)
330	10	M	3	J	6.10 (0.240)
083	12	K	3	N	6.10 (0.240)
084	12	M	3	N	6.10 (0.240)
331	12	K	3	J	6.10 (0.240)
332	12	M	3	J	6.10 (0.240)



SMPS Stacked MLC Capacitors



(SM Style) SM Military Styles DSCC Dwg. #87106 (X7R)

Electrical characteristics

DSCC Dwg. 87106-	Cap. Value (µF)	Cap. Tol.	Case Code	Lead Style	Max. A Dimension mm (inches)
100V					
085	15	K	3	N	9.14 (0.360)
086	15	M	3	N	9.14 (0.360)
333	15	K	3	J	9.14 (0.360)
334	15	M	3	J	9.14 (0.360)
087	18	K	3	N	9.14 (0.360)
088	18	M	3	N	9.14 (0.360)
335	18	K	3	J	9.14 (0.360)
336	18	M	3	J	9.14 (0.360)
089	22	K	3	N	12.2 (0.480)
090	22	M	3	N	12.2 (0.480)
337	22	M	3	K	12.2 (0.480)
338	22	M	3	J	12.2 (0.480)
091	27	K	3	N	16.5 (0.650)
092	27	M	3	N	16.5 (0.650)
339	27	K	3	J	16.5 (0.650)
340	27	M	3	J	16.5 (0.650)
093	33	K	1	N	9.14 (0.360)
094	33	M	1	N	9.14 (0.360)
341	33	K	1	J	9.14 (0.360)
342	33	M	1	J	9.14 (0.360)
095	39	K	1	N	12.2 (0.480)
096	39	M	1	N	12.2 (0.480)
343	39	K	1	J	12.2 (0.480)
344	39	M	1	J	12.2 (0.480)
097	47	K	1	N	12.2 (0.480)
098	47	M	1	N	12.2 (0.480)
345	47	K	1	J	12.2 (0.480)
346	47	M	1	J	12.2 (0.480)
099	56	K	1	N	16.5 (0.650)
100	56	M	1	N	16.5 (0.650)
347	56	K	1	J	16.5 (0.650)
348	56	M	1	J	16.5 (0.650)
101	68	K	2	N	12.2 (0.480)
102	68	M	2	N	12.2 (0.480)
349	68	K	2	J	12.2 (0.480)
350	68	M	2	J	12.2 (0.480)
103	82	K	2	N	16.5 (0.650)
104	82	M	2	N	16.5 (0.650)
351	82	K	2	J	16.5 (0.650)
352	82	M	2	J	16.5 (0.650)
105	100	K	6	N	9.14 (0.360)
106	100	M	6	N	9.14 (0.360)
353	100	K	6	J	9.14 (0.360)
354	100	M	6	J	9.14 (0.360)
107	120	K	6	N	9.14 (0.360)
108	120	M	6	N	9.14 (0.360)
355	120	K	6	J	9.14 (0.360)
356	120	M	6	J	9.14 (0.360)
109	150	K	6	N	12.2 (0.480)
110	150	M	6	N	12.2 (0.480)
357	150	K	6	J	12.2 (0.480)
358	150	M	6	J	12.2 (0.480)
111	180	K	6	N	16.5 (0.650)
112	180	M	6	N	16.5 (0.650)
359	180	K	6	J	16.5 (0.650)
360	180	M	6	J	16.5 (0.650)

DSCC Dwg. 87106-	Cap. Value (µF)	Cap. Tol.	Case Code	Lead Style	Max. A Dimension mm (inches)
200V					
113	.47	K	5	N	6.10 (0.240)
114	.47	M	5	N	6.10 (0.240)
361	.47	K	5	J	6.10 (0.240)
362	.47	M	5	J	6.10 (0.240)
115	.56	K	5	N	6.10 (0.240)
116	.56	M	5	N	6.10 (0.240)
363	.56	K	5	J	6.10 (0.240)
364	.56	M	5	J	6.10 (0.240)
117	.68	K	5	N	9.14 (0.360)
118	.68	M	5	N	9.14 (0.360)
365	.68	K	5	J	9.14 (0.360)
366	.68	M	5	J	9.14 (0.360)
119	.82	K	5	N	9.14 (0.360)
120	.82	M	5	N	9.14 (0.360)
367	.82	M	5	J	9.14 (0.360)
368	.82	M	5	J	9.14 (0.360)
121	1.0	K	5	N	12.2 (0.480)
122	1.0	M	5	N	12.2 (0.480)
369	1.0	K	5	J	12.2 (0.480)
370	1.0	M	5	J	12.2 (0.480)
123	1.2	K	5	N	12.2 (0.480)
124	1.2	M	5	N	12.2 (0.480)
371	1.2	K	5	J	12.2 (0.480)
372	1.2	M	5	J	12.2 (0.480)
125	1.5	K	5	N	16.5 (0.650)
126	1.5	M	5	N	16.5 (0.650)
373	1.5	K	5	J	16.5 (0.650)
374	1.5	M	5	J	16.5 (0.650)
127	1.8	K	4	N	9.14 (0.360)
128	1.8	M	4	N	9.14 (0.360)
375	1.8	K	4	J	9.14 (0.360)
376	1.8	M	4	J	9.14 (0.360)
129	2.2	K	4	N	9.14 (0.360)
130	2.2	M	4	N	9.14 (0.360)
377	2.2	K	4	J	9.14 (0.360)
378	2.2	M	4	J	9.14 (0.360)
131	2.7	K	4	N	12.2 (0.480)
132	2.7	M	4	N	12.2 (0.480)
379	2.7	K	4	J	12.2 (0.480)
380	2.7	M	4	J	12.2 (0.480)
133	3.3	K	4	N	12.2 (0.480)
134	3.3	M	4	N	12.2 (0.480)
381	3.3	K	4	J	12.2 (0.480)
382	3.3	M	4	J	12.2 (0.480)
135	3.9	K	4	N	16.5 (0.650)
136	3.9	M	4	N	16.5 (0.650)
383	3.9	K	4	J	16.5 (0.650)
384	3.9	M	4	J	16.5 (0.650)
137	4.7	K	3	N	6.10 (0.240)
138	4.7	M	3	N	6.10 (0.240)
385	4.7	K	3	J	6.10 (0.240)
386	4.7	M	3	J	6.10 (0.240)
139	5.6	K	3	N	6.10 (0.240)
140	5.6	M	3	N	6.10 (0.240)
387	5.6	K	3	J	6.10 (0.240)
388	5.6	M	3	J	6.10 (0.240)
141	6.8	K	3	N	9.14 (0.360)
142	6.8	M	3	N	9.14 (0.360)
389	6.8	K	3	J	9.14 (0.360)
390	6.8	M	3	J	9.14 (0.360)
143	8.2	K	3	N	9.14 (0.360)
144	8.2	M	3	N	9.14 (0.360)
391	8.2	K	3	J	9.14 (0.360)
392	8.2	M	3	J	9.14 (0.360)

DSCC Dwg. 87106-	Cap. Value (µF)	Cap. Tol.	Case Code	Lead Style	Max. A Dimension mm (inches)
200V					
145	10	K	3	N	12.2 (0.480)
146	10	M	3	N	12.2 (0.480)
393	10	K	3	J	12.2 (0.480)
394	10	M	3	J	12.2 (0.480)
147	12	K	3	N	16.5 (0.650)
148	12	M	3	N	16.5 (0.650)
395	12	K	3	J	16.5 (0.650)
396	12	M	3	J	16.5 (0.650)
149	15	K	1	N	9.14 (0.360)
150	15	M	1	N	9.14 (0.360)
397	15	K	1	J	9.14 (0.360)
398	15	M	1	J	9.14 (0.360)
151	18	K	1	N	12.2 (0.480)
152	18	M	1	N	12.2 (0.480)
399	18	K	1	J	12.2 (0.480)
400	18	M	1	J	12.2 (0.480)
153	22	K	1	N	16.5 (0.650)
154	22	M	1	N	16.5 (0.650)
401	22	K	1	J	16.5 (0.650)
402	22	M	1	J	16.5 (0.650)
155	27	K	1	N	16.5 (0.650)
156	27	M	1	N	16.5 (0.650)
403	27	K	1	J	16.5 (0.650)
404	27	M	1	J	16.5 (0.650)
157	33	K	2	N	12.2 (0.480)
158	33	M	2	N	12.2 (0.480)
405	33	K	2	J	12.2 (0.480)
406	33	M	2	J	12.2 (0.480)
159	39	K	2	N	16.5 (0.650)
160	39	M	2	N	16.5 (0.650)
407	39	K	2	J	16.5 (0.650)
408	39	M	2	J	16.5 (0.650)
161	47	K	6	N	6.10 (0.240)
162	47	M	6	N	6.10 (0.240)
409	47	K	6	J	6.10 (0.240)
410	47	M	6	J	6.10 (0.240)
163	56	K	6	N	9.14 (0.360)
164	56	M	6	N	9.14 (0.360)
411	56	K	6	J	9.14 (0.360)
412	56	M	6	J	9.14 (0.360)
165	68	K	6	N	9.14 (0.360)
166	68	M	6	N	9.14 (0.360)
413	68	K	6	J	9.14 (0.360)
414	68	M	6	J	9.14 (0.360)
167	82	K	6	N	12.2 (0.480)
168	82	M	6	N	12.2 (0.480)
415	82	K	6	J	12.2 (0.480)
416	82	M	6	J	12.2 (0.480)
169	100	K	6	N	16.5 (0.650)
170	100	M	6	N	16.5 (0.650)
417	100	K	6	J	16.5 (0.650)
418	100	M	6	J	16.5 (0.650)
171	120	K	6	N	16.5 (0.650)
172	120	M	6	N	16.5 (0.650)
419	120	K	6	J	16.5 (0.650)
420	120	M	6	J	16.5 (0.650)



SMPS Stacked MLC Capacitors



(SM Style) SM Military Styles DSCC Dwg. #87106 (X7R)

Electrical characteristics

DSCC Dwg. 87106-	Cap. Value (µF)	Cap. Tol.	Case Code	Lead Style	Max. A Dimension mm (inches)
500V					
173	.15	K	5	N	3.05 (0.120)
174	.15	M	5	N	3.05 (0.120)
421	.15	K	5	J	3.05 (0.120)
422	.15	M	5	J	3.05 (0.120)
175	.18	K	5	N	6.10 (0.240)
176	.18	M	5	N	6.10 (0.240)
423	.18	K	5	J	6.10 (0.240)
424	.18	M	5	J	6.10 (0.240)
177	.22	K	5	N	6.10 (0.240)
178	.22	M	5	N	6.10 (0.240)
425	.22	K	5	J	6.10 (0.240)
426	.22	M	5	J	6.10 (0.240)
179	.27	K	5	N	6.10 (0.240)
180	.27	M	5	N	6.10 (0.240)
427	.27	K	5	J	6.10 (0.240)
428	.27	M	5	J	6.10 (0.240)
181	.33	K	5	N	9.14 (0.360)
182	.33	M	5	N	9.14 (0.360)
429	.33	K	5	J	9.14 (0.360)
430	.33	M	5	J	9.14 (0.360)
183	.39	K	5	N	9.14 (0.360)
184	.39	M	5	N	9.14 (0.360)
431	.39	K	5	J	9.14 (0.360)
432	.39	M	5	J	9.14 (0.360)
185	.47	K	5	N	9.14 (0.360)
186	.47	M	5	N	9.14 (0.360)
433	.47	K	5	J	9.14 (0.360)
434	.47	M	5	J	9.14 (0.360)
187	.56	K	5	N	12.2 (0.480)
188	.56	M	5	N	12.2 (0.480)
435	.56	K	5	J	12.2 (0.480)
436	.56	M	5	J	12.2 (0.480)
189	.68	K	5	N	16.5 (0.650)
190	.68	M	5	N	16.5 (0.650)
437	.68	K	5	J	16.5 (0.650)
438	.68	M	5	J	16.5 (0.650)
231	.82	K	4	N	9.14 (0.360)
232	.82	M	4	N	9.14 (0.360)
439	.82	K	4	J	9.14 (0.360)
440	.82	M	4	J	9.14 (0.360)
191	1.0	K	4	N	9.14 (0.360)
192	1.0	M	4	N	9.14 (0.360)
441	1.0	K	4	J	9.14 (0.360)
442	1.0	M	4	J	9.14 (0.360)
193	1.2	K	4	N	9.14 (0.360)
194	1.2	M	4	N	9.14 (0.360)
443	1.2	K	4	J	9.14 (0.360)
444	1.2	M	4	J	9.14 (0.360)
195	1.5	K	4	N	12.2 (0.480)
196	1.5	M	4	N	12.2 (0.480)
445	1.5	K	4	J	12.2 (0.480)
446	1.5	M	4	J	12.2 (0.480)
197	1.8	K	4	N	16.5 (0.650)
198	1.8	M	4	N	16.5 (0.650)
447	1.8	K	4	J	16.5 (0.650)
448	1.8	M	4	J	16.5 (0.650)
233	2.2	K	3	N	6.10 (0.240)
234	2.2	M	3	N	6.10 (0.240)
449	2.2	K	3	J	6.10 (0.240)
450	2.2	M	3	J	6.10 (0.240)
199	2.7	K	3	N	9.14 (0.360)
200	2.7	M	3	N	9.14 (0.360)
451	2.7	K	3	J	9.14 (0.360)
452	2.7	M	3	J	9.14 (0.360)

DSCC Dwg. 87106-	Cap. Value (µF)	Cap. Tol.	Case Code	Lead Style	Max. A Dimension mm (inches)
500V					
201	3.3	K	3	N	9.14 (0.360)
202	3.3	M	3	N	9.14 (0.360)
453	3.3	K	3	J	9.14 (0.360)
454	3.3	M	3	J	9.14 (0.360)
203	3.9	K	3	N	9.14 (0.360)
204	3.9	M	3	N	9.14 (0.360)
455	3.9	K	3	J	9.14 (0.360)
456	3.9	M	3	J	9.14 (0.360)
205	4.7	K	3	N	12.2 (0.480)
206	4.7	M	3	N	12.2 (0.480)
457	4.7	K	3	J	12.2 (0.480)
458	4.7	M	3	J	12.2 (0.480)
207	5.6	K	3	N	16.5 (0.650)
208	5.6	M	3	N	16.5 (0.650)
459	5.6	K	3	J	16.5 (0.650)
460	5.6	M	3	J	16.5 (0.650)
235	6.8	K	1	N	12.2 (0.480)
236	6.8	M	1	N	12.2 (0.480)
461	6.8	K	1	J	12.2 (0.480)
462	6.8	M	1	J	12.2 (0.480)
209	8.2	K	1	N	12.2 (0.480)
210	8.2	M	1	N	12.2 (0.480)
463	8.2	K	1	J	12.2 (0.480)
464	8.2	M	1	J	12.2 (0.480)
211	10	K	1	N	12.2 (0.480)
212	10	M	1	N	12.2 (0.480)
465	10	K	1	J	12.2 (0.480)
466	10	M	1	J	12.2 (0.480)
213	12	K	1	N	16.5 (0.650)
214	12	M	1	N	16.5 (0.650)
467	12	K	1	J	16.5 (0.650)
468	12	M	1	J	16.5 (0.650)
237	15	K	2	N	16.5 (0.650)
238	15	M	2	N	16.5 (0.650)
469	15	K	2	J	16.5 (0.650)
470	15	M	2	J	16.5 (0.650)
215	18	K	2	N	16.5 (0.650)
216	18	M	2	N	16.5 (0.650)
471	18	K	2	J	16.5 (0.650)
472	18	M	2	J	16.5 (0.650)
239	22	K	6	N	9.14 (0.360)
240	22	M	6	N	9.14 (0.360)
473	22	K	6	J	9.14 (0.360)
474	22	M	6	J	9.14 (0.360)
217	27	K	6	N	9.14 (0.360)
218	27	M	6	N	9.14 (0.360)
475	27	K	6	J	9.14 (0.360)
476	27	M	6	J	9.14 (0.360)
219	33	K	6	N	12.2 (0.480)
220	33	M	6	N	12.2 (0.480)
477	33	K	6	J	12.2 (0.480)
478	33	M	6	J	12.2 (0.480)
221	39	K	6	N	16.5 (0.650)
222	39	M	6	N	16.5 (0.650)
479	39	K	6	J	16.5 (0.650)
480	39	M	6	J	16.5 (0.650)





Компания «ЭлектроПласт» предлагает заключение долгосрочных отношений при поставках импортных электронных компонентов на взаимовыгодных условиях!

Наши преимущества:

- Оперативные поставки широкого спектра электронных компонентов отечественного и импортного производства напрямую от производителей и с крупнейших мировых складов;
- Поставка более 17-ти миллионов наименований электронных компонентов;
- Поставка сложных, дефицитных, либо снятых с производства позиций;
- Оперативные сроки поставки под заказ (от 5 рабочих дней);
- Экспресс доставка в любую точку России;
- Техническая поддержка проекта, помощь в подборе аналогов, поставка прототипов;
- Система менеджмента качества сертифицирована по Международному стандарту ISO 9001;
- Лицензия ФСБ на осуществление работ с использованием сведений, составляющих государственную тайну;
- Поставка специализированных компонентов (Xilinx, Altera, Analog Devices, Intersil, Interpoint, Microsemi, Aeroflex, Peregrine, Syfer, Eurofarad, Texas Instrument, Miteq, Cobham, E2V, MA-COM, Hittite, Mini-Circuits, General Dynamics и др.);

Помимо этого, одним из направлений компании «ЭлектроПласт» является направление «Источники питания». Мы предлагаем Вам помощь Конструкторского отдела:

- Подбор оптимального решения, техническое обоснование при выборе компонента;
- Подбор аналогов;
- Консультации по применению компонента;
- Поставка образцов и прототипов;
- Техническая поддержка проекта;
- Защита от снятия компонента с производства.



Как с нами связаться

Телефон: 8 (812) 309 58 32 (многоканальный)

Факс: 8 (812) 320-02-42

Электронная почта: org@eplast1.ru

Адрес: 198099, г. Санкт-Петербург, ул. Калинина, дом 2, корпус 4, литера А.