

## Interference Suppression Film Capacitor - Class X1 Radial MKP 480 V<sub>AC</sub> - 3-Phase Across the Line



### FEATURES

- 10 mm to 27.5 mm lead pitch
- Internal series construction
- Stable capacitance in severe ambient conditions 85 °C, 85 % RH, 400 V<sub>AC</sub>, 500 h
- Material categorization:  
For definitions of compliance please see [www.vishay.com/doc?99912](http://www.vishay.com/doc?99912)



**RoHS**  
COMPLIANT  
HALOGEN  
**FREE**  
**GREEN**  
(5-2008)

### APPLICATIONS

- 3-phase and continuous across the line X1 applications
- Standard and continuous in series with the mains operation

See also application note: [www.vishay.com/doc?28153](http://www.vishay.com/doc?28153)

QUICK REFERENCE DATA	
Capacitance range (E12 series)	0.001 µF to 1.0 µF (preferred values according to E6)
Capacitance tolerance	± 20 %; ± 10 %; (± 5 % on request)
Climatic testing class according to IEC 60068-1	55/110/56/B
Rated AC voltage	480 V <sub>AC</sub> ; 50 Hz to 60 Hz
Permissible DC voltage	1000 V <sub>DC</sub> at 85 °C 800 V <sub>DC</sub> at 110 °C
Maximum application temperature	110 °C
Reference standards	IEC 60384-14 and EN 60384-14 IEC 60065 requires pass. flamm. class B CSA-E384-14; UL 60384-14 CQC
Dielectric	Polypropylene film
Electrodes	Metallized
Construction	Series construction 
Encapsulation	Plastic case, epoxy resin sealed, flame retardant UL-class 94 V-0
Leads	Tinned wire
Marking	C-value; tolerance; rated voltage; sub-class; manufacturer's type; code for dielectric material; manufacturer location, year and week; manufacturer's logo or name; safety approvals

#### Note

- For more detailed data and test requirements, contact [rfi@vishay.com](mailto:rfi@vishay.com)

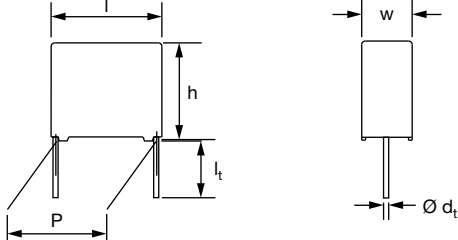
DIMENSIONS in millimeters



**COMPOSITION OF CATALOG NUMBER**



**Notes**

- For detailed tape specifications refer to packaging information [www.vishay.com/doc?28139](http://www.vishay.com/doc?28139)
- <sup>(1)</sup> Packaging will be bulk for all capacitors with pitch ≤ 15 mm and such with long leads (> 5 mm). Capacitors with short leads up to 5 mm and pitch > 15 mm will be in tray and asking code will be "T".



SPECIFIC REFERENCE DATA		
DESCRIPTION	VALUE	
Rated AC voltage ( $U_{RAC}$ )	480 V	
Permissible DC voltage ( $U_{RDC}$ )	1000 V	
Tangent of loss angle	At 1 kHz	At 10 kHz
$C < 470 \text{ nF}$	$\leq 10 \times 10^{-4}$	$\leq 20 \times 10^{-4}$
$470 \text{ nF} \leq C \leq 1 \mu\text{F}$	$\leq 20 \times 10^{-4}$	$\leq 70 \times 10^{-4}$
$C > 1 \mu\text{F}$	$\leq 30 \times 10^{-4}$	-
Rated voltage pulse slope ( $dU/dt$ ) <sub>R</sub> at 670 V	100 V/ $\mu\text{s}$	
R between leads, for $C \leq 0.33 \mu\text{F}$ at 100 V; 1 min	$> 15\,000 \text{ M}\Omega$	
RC between leads, for $C > 0.33 \mu\text{F}$ at 100 V; 1 min	$> 5000 \text{ s}$	
R between leads and case; 100 V; 1 min	$> 30\,000 \text{ M}\Omega$	
Withstanding (DC) voltage (cut off current 10 mA) <sup>(1)</sup> ; rise time $\leq 1000 \text{ V/s}$ : $C \leq 1.2 \mu\text{F}$	3400 V; 1 min	
Withstanding (AC) voltage between leads and case	2380 V; 1 min	
Maximum application temperature	110 °C	

**Note**

<sup>(1)</sup> See "Voltage Proof Test for Metalized Film Capacitors": [www.vishay.com/doc?28169](http://www.vishay.com/doc?28169)

ELECTRICAL DATA AND ORDERING INFORMATION										
$U_{RAC}$ (V)	CAP. ( $\mu\text{F}$ )	DIMENSIONS w x h x l (mm)	MASS (g) <sup>(3)</sup>	CATALOG NUMBER F339X1... AND PACKAGING						
				LOOSE IN BOX					TAPED REEL	
				SHORT LEADS			LONG LEADS			
				$l_t = 3.5 \text{ mm} +1 \text{ mm}/-0.5 \text{ mm}$ (PITCH $\leq 10 \text{ mm}$ ) or $3.5 \text{ mm} \pm 0.3 \text{ mm}$ (PITCH $\geq 15 \text{ mm}$ )	$l_t = 5.0 \text{ mm} \pm 1.0 \text{ mm}$	SPQ	$l_t = 25.0 \text{ mm} \pm 2.0 \text{ mm}$	SPQ	$\varnothing = 500 \text{ mm}$ <sup>(1)(2)</sup> $H = 18.5 \text{ mm}$ ; $P_0 = 12.7 \text{ mm}$	SPQ
<b>PITCH = 10 mm <math>\pm</math> 0.4 mm; <math>d_t = 0.60 \text{ mm} \pm 0.06 \text{ mm}</math>; C-TOL. = <math>\pm 20 \%</math></b>										
0.0010	4.0 x 10.0 x 12.5	0.6	21048MDA2B0	21048MDM2B0	1000	21048MDI2B0	1250	21048MD02W0	1400	
0.0015			21548MDA2B0	21548MDM2B0		21548MDI2B0		21548MD02W0		
0.0022			22248MDA2B0	22248MDM2B0		22248MDI2B0		22248MD02W0		
0.0033			23348MDA2B0	23348MDM2B0		23348MDI2B0		23348MD02W0		
0.0047	5.0 x 11.0 x 12.5	0.82	24748MDA2B0	24748MDM2B0	1000	24748MDI2B0	1000	24748MD02W0	1100	
0.0068	6.0 x 12.0 x 12.5	1.1	26848MDA2B0	26848MDM2B0	750	26848MDI2B0	750	26848MD02W0	900	
0.010			31048MDA2B0	31048MDM2B0		31048MDI2B0		31048MD02W0		
<b>PITCH = 15 mm <math>\pm</math> 0.4 mm; <math>d_t = 0.60 \text{ mm} \pm 0.06 \text{ mm}</math>; C-TOL. = <math>\pm 20 \%</math></b>										
0.010	5.0 x 11.0 x 17.5	1.0	31048MFP2B0	31048MFM2B0	1250	31048MFI2B0	1000	31048MF02W0	1100	
0.015			31548MFP2B0	31548MFM2B0		31548MFI2B0		31548MF02W0		
0.022			32248MFP2B0	32248MFM2B0		32248MFI2B0		32248MF02W0		
0.033			33348MFP2B0	33348MFM2B0		33348MFI2B0		33348MF02W0		
0.047	6.0 x 12.0 x 17.5	1.4	34748MFP2B0	34748MFM2B0	1000	34748MFI2B0	1000	34748MF02W0	900	
<b>PITCH = 15 mm <math>\pm</math> 0.4 mm; <math>d_t = 0.80 \text{ mm} \pm 0.08 \text{ mm}</math>; C-TOL. = <math>\pm 20 \%</math></b>										
0.068	8.5 x 15.0 x 17.5	2.4	36848MFP2B0	36848MFM2B0	750	36848MFI2B0	500	36848MF02W0	650	
0.100	10 x 16.5 x 17.5	3.0	41048MFP2B0	41048MFM2B0	500	41048MFI2B0	450	41048MF02W0	600	
<b>PITCH = 22.5 mm <math>\pm</math> 0.4 mm; <math>d_t = 0.80 \text{ mm} \pm 0.08 \text{ mm}</math>; C-TOL. = <math>\pm 20 \%</math></b>										
0.047	6.0 x 15.5 x 26.0	2.4	34748MIP2T0	34748MIM2T0	300	34748MII2B0	250	34748MI02W0	600	
0.068			36848MIP2T0	36848MIM2T0		36848MII2B0		36848MI02W0		
0.10			41048MIP2T0	41048MIM2T0		41048MII2B0		41048MI02W0		
0.15	7.0 x 16.5 x 26.0	2.9	41548MIP2T0	41548MIM2T0	200	41548MII2B0	250	41548MI02W0	500	
0.22	8.5 x 18.0 x 26.0	3.8	42248MIP2T0	42248MIM2T0	200	42248MII2B0	250	42248MI02W0	450	
0.33	12 x 22.0 x 26.0	7.8	43348MIP2T0	43348MIM2T0	150	43348MII2B0	200	43348MI02W0	300	





ELECTRICAL DATA AND ORDERING INFORMATION										
U <sub>RAC</sub> (V)	CAP. (μF)	DIMENSIONS w x h x l (mm)	MASS (g) <sup>(3)</sup>	CATALOG NUMBER F339X1... AND PACKAGING						
				LOOSE IN BOX					TAPED REEL	
				SHORT LEADS		LONG LEADS			TAPED REEL	
				l <sub>t</sub> = 3.5 mm +1 mm/-0.5 mm (PITCH ≤ 10 mm) or 3.5 mm ± 0.3 mm (PITCH ≥ 15 mm)		l <sub>t</sub> = 5.0 mm ± 1.0 mm	SPQ	l <sub>t</sub> = 25.0 mm ± 2.0 mm		SPQ
<b>PITCH = 27.5 mm ± 0.4 mm; d<sub>t</sub> = 0.80 mm ± 0.08 mm; C-TOL. = ± 20 %</b>										
0.15	9.0 x 19.0 x 31.5	5.5	41548MKP2T0	41548MKM2T0	100	41548MKI2B0	150			
0.22			42248MKP2T0	42248MKM2T0		42248MKI2B0				
0.33	11.0 x 21.0 x 31.0	7.4	43348MKP2T0	43348MKM2T0	100	43348MKI2B0	125			
0.47	13.0 x 23.0 x 31.0	9.2	44748MKP2T0	44748MKM2T0	100	44748MKI2B0	125			
0.68	15.0 x 25.0 x 31.5	12.3	46848MKP2T0	46848MKM2T0	100	46848MKI2B0	125			
1.0	18.0 x 28.0 x 31.5	16.1	51048MKP2T0	51048MKM2T0	100	51048MKI2B0	100			
<b>PITCH = 10.0 mm ± 0.4 mm; d<sub>t</sub> = 0.60 mm ± 0.06 mm; C-TOL. = ± 10 %</b>										
0.0010	4.0 x 10.0 x 12.5	0.6	21048KDA2B0	21048KDM2B0	1000	21048KDI2B0	1250	21048KD02W0	1400	
0.0012			21248KDA2B0	21248KDM2B0		21248KDI2B0		21248KD02W0		
0.0015			21548KDA2B0	21548KDM2B0		21548KDI2B0		21548KD02W0		
0.0018			21848KDA2B0	21848KDM2B0		21848KDI2B0		21848KD02W0		
0.0022			22248KDA2B0	22248KDM2B0		22248KDI2B0		22248KD02W0		
0.0027			22748KDA2B0	22748KDM2B0		22748KDI2B0		22748KD02W0		
0.0033			23348KDA2B0	23348KDM2B0		23348KDI2B0		23348KD02W0		
0.0039			23948KDA2B0	23948KDM2B0		23948KDI2B0		23948KD02W0		
0.0047	5.0 x 11.0 x 12.5	0.82	24748KDA2B0	24748KDM2B0	1000	24748KDI2B0	1000	24748KD02W0	1100	
0.0056			25648KDA2B0	25648KDM2B0		25648KDI2B0		25648KD02W0		
0.0068	6.0 x 12.0 x 12.5	1.1	26848KDA2B0	26848KDM2B0	750	26848KDI2B0	750	26848KD02W0	900	
0.0082			28248KDA2B0	28248KDM2B0		28248KDI2B0		28248KD02W0		
<b>PITCH = 15.0 mm ± 0.4 mm; d<sub>t</sub> = 0.60 mm ± 0.06 mm; C-TOL. = ± 10 %</b>										
0.010	5.0 x 11.0 x 17.5	1.0	31048KFP2B0	31048KFM2B0	1250	31048KFI2B0	1000	31048KF02W0	1100	
0.012			31248KFP2B0	31248KFM2B0		31248KFI2B0		31248KF02W0		
0.015			31548KFP2B0	31548KFM2B0		31548KFI2B0		31548KF02W0		
0.018			31848KFP2B0	31848KFM2B0		31848KFI2B0		31848KF02W0		
0.022			32248KFP2B0	32248KFM2B0		32248KFI2B0		32248KF02W0		
0.027			32748KFP2B0	32748KFM2B0		32748KFI2B0		32748KF02W0		
0.033	6.0 x 12.0 x 17.5	1.4	33348KFP2B0	33348KFM2B0	1000	33348KFI2B0	1000	33348KF02W0	900	
0.039			33948KFP2B0	33948KFM2B0		33948KFI2B0		33948KF02W0		
<b>PITCH = 15.0 mm ± 0.4 mm; d<sub>t</sub> = 0.80 mm ± 0.08 mm; C-TOL. = ± 10 %</b>										
0.047	7.0 x 13.5 x 17.5	1.8	34748KFP2B0	34748KFM2B0	750	34748KFI2B0	500	34748KF02W0	800	
0.056			35648KFP2B0	35648KFM2B0		35648KFI2B0		35648KF02W0		
0.068	8.5 x 15.0 x 17.5	2.4	36848KFP2B0	36848KFM2B0	750	36848KFI2B0	500	36848KF02W0	650	
0.082			38248KFP2B0	38248KFM2B0		38248KFI2B0		38248KF02W0		
0.100	10.0 x 16.5 x 17.5	3.0	41048KFP2B0	41048KFM2B0	500	41048KFI2B0	450	41048KF02W0	600	

ELECTRICAL DATA AND ORDERING INFORMATION										
U <sub>RAC</sub> (V)	CAP. (μF)	DIMENSIONS w x h x l (mm)	MASS (g) <sup>(3)</sup>	CATALOG NUMBER F339X1... AND PACKAGING						
				LOOSE IN BOX					TAPED REEL	
				SHORT LEADS			LONG LEADS			
				l <sub>t</sub> = 3.5 mm +1 mm/-0.5 mm (PITCH ≤ 10 mm) or 3.5 mm ± 0.3 mm (PITCH ≥ 15 mm)	l <sub>t</sub> = 5.0 mm ± 1.0 mm	SPQ	l <sub>t</sub> = 25.0 mm ± 2.0 mm	SPQ	Ø = 500 mm <sup>(1)(2)</sup> H = 18.5 mm; P <sub>0</sub> = 12.7 mm	SPQ
480	PITCH = 22.5 mm ± 0.4 mm; d <sub>t</sub> = 0.80 mm ± 0.08 mm; C-TOL. = ± 10 %									
	0.047	6.0 x 15.5 x 26.0	2.4	34748KIP2T0	34748KIM2T0	300	34748KII2B0	250	34748KI02W0	600
	0.056			35648KIP2T0	35648KIM2T0		35648KII2B0		35648KI02W0	
	0.068			36848KIP2T0	36848KIM2T0		36848KII2B0		36848KI02W0	
	0.082			38248KIP2T0	38248KIM2T0		38248KII2B0		38248KI02W0	
	0.10			41048KIP2T0	41048KIM2T0		41048KII2B0		41048KI02W0	
	0.12	7.0 x 16.5 x 26.0	2.9	41248KIP2T0	41248KIM2T0	200	41248KII2B0	250	41248KI02W0	500
	0.15	8.5 x 18.0 x 26.0	3.8	41548KIP2T0	41548KIM2T0	200	41548KII2B0	250	41548KI02W0	450
	0.18			41848KIP2T0	41848KIM2T0		41848KII2B0		41848KI02W0	
	0.22	10.0 x 19.5 x 26.0	6.8	42248KIP2T0	42248KIM2T0	200	42248KII2B0	200	42248KI02W0	350
	0.27	12.0 x 22.0 x 26.0	7.8	42748KIP2T0	42748KIM2T0	150	42748KII2B0	200	42748KI02W0	300
	0.33			43348KIP2T0	43348KIM2T0		43348KII2B0		43348KI02W0	
	PITCH = 27.5 mm ± 0.4 mm; d <sub>t</sub> = 0.80 mm ± 0.08 mm; C-TOL. = ± 10 %									
	0.15	9.0 x 19.0 x 31.5	5.5	41548KKP2T0	41548KKM2T0	100	41548KKI2B0	150		
	0.18			41848KKP2T0	41848KKM2T0		41848KKI2B0			
	0.22			42248KKP2T0	42248KKM2T0		42248KKI2B0			
	0.27	11.0 x 21.0 x 31.0	7.4	42748KKP2T0	42748KKM2T0	100	42748KKI2B0	125		
	0.33			43348KKP2T0	43348KKM2T0		43348KKI2B0			
	0.39	13.0 x 23.0 x 31.0	9.2	43948KKP2T0	43948KKM2T0	100	43948KKI2B0	125		
	0.47			44748KKP2T0	44748KKM2T0		44748KKI2B0			
0.56	15.0 x 25.0 x 31.5	12.3	45648KKP2T0	45648KKM2T0	100	45648KKI2B0	125			
0.68	18.0 x 28.0 x 31.5	16.1	46848KKP2T0	46848KKM2T0	100	46848KKI2B0	100			
0.82			48248KKP2T0	48248KKM2T0		48248KKI2B0				
1.0	21.0 x 31.0 x 31.0	20.3	51048KKP2T0	51048KKM2T0	50	51048KKI2B0	75			

**Notes**

- SPQ = Standard Packing Quantity
- (1) Reel diameter = 356 mm is available on request
- (2) H = in-tape height; P<sub>0</sub> = sprocket hole distance; for detailed specifications refer to "Packaging Information"
- (3) Weight for short lead product only

APPROVALS				
SAFETY APPROVALS X1	VOLTAGE	VALUE	FILE NUMBERS	LINK
EN 60384-14 (ENEC) (= IEC 60384-14 ed-3)	480 V <sub>AC</sub>	1 nF to 1.0 μF	40033060	<a href="http://www.vishay.com/doc?28230">www.vishay.com/doc?28230</a>
UL 60384-14	480 V <sub>AC</sub>	1 nF to 1.0 μF	E354331A	<a href="http://www.vishay.com/doc?28209">www.vishay.com/doc?28209</a>
CSA-E384-14	480 V <sub>AC</sub>	1 nF to 1.0 μF	E354331A	<a href="http://www.vishay.com/doc?28209">www.vishay.com/doc?28209</a>
CQC	480 V <sub>AC</sub>	1 nF to 1.0 μF	Pending	
CB-test certificate	480 V <sub>AC</sub>	1 nF to 1.0 μF	DE1-48823/M1	<a href="http://www.vishay.com/doc?28219">www.vishay.com/doc?28219</a>
The ENEC-approval together with the CB-certificate replace all national marks of the following countries (they have already signed the ENEC-agreement): Austria; Belgium; Czech. Republic; Denmark; Finland; France; Germany; Greece; Hungary; Ireland; Italy; Luxembourg; Netherlands; Norway; Portugal; Slovenian; Spain; Sweden, Switzerland and United Kingdom.				
  				

## MOUNTING

### Normal Use

The capacitors are designed for mounting on printed-circuit boards. The capacitors packed in bandoliers are designed for mounting on printed-circuit boards by means of automatic insertion machines.

For detailed tape specifications refer to packaging information [www.vishay.com/docs?28139](http://www.vishay.com/docs?28139)

### Specific Method of Mounting to Withstand Vibration and Shock

In order to withstand vibration and shock tests, it must be ensured that the stand-off pips are in good contact with the printed-circuit board:

- For original pitch  $\leq 15$  mm the capacitors shall be mechanically fixed by the leads
- For larger pitches the capacitors shall be mounted in the same way and the body clamped

### Space Requirements on Printed-Circuit Board

The maximum space for length ( $l_{max.}$ ), width ( $w_{max.}$ ) and height ( $h_{max.}$ ) of film capacitors to take in account on the printed circuit board is shown in the drawings.

- For products with pitch  $\leq 15$  mm,  $\Delta w = \Delta l = 0.3$  mm and  $\Delta h = 0.1$  mm
- For products with  $15$  mm  $<$  pitch  $\leq 27.5$  mm,  $\Delta w = \Delta l = 0.5$  mm and  $\Delta h = 0.1$  mm

Eccentricity defined as in drawing. The maximum eccentricity is smaller than or equal to the lead diameter of the product concerned.



## SOLDERING CONDITIONS

For general soldering conditions and wave soldering profile we refer to the document "Soldering Guidelines for Film Capacitors": [www.vishay.com/doc?28171](http://www.vishay.com/doc?28171)

## STORAGE TEMPERATURE

$T_{stg} = -25$  °C to  $+35$  °C with RH maximum 75 % without condensation

## RATINGS AND CHARACTERISTICS REFERENCE CONDITIONS

Unless otherwise specified, all electrical values apply to an ambient free temperature of  $23$  °C  $\pm 1$  °C, an atmospheric pressure of 86 kPa to 106 kPa and a relative humidity of  $50$  %  $\pm 2$  %.

For reference testing, a conditioning period shall be applied over  $96$  h  $\pm 4$  h by heating the products in a circulating air oven at the rated temperature and a relative humidity not exceeding 20 %.



CHARACTERISTICS

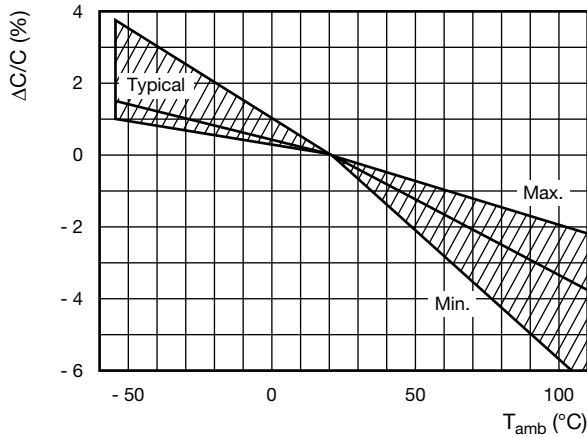

Capacitance as a function of ambient temperature (typical curve)



Tangent of loss angle as a function of frequency (typical curve)



Impedance as a function of frequency (typical curve)



Resonant frequency as a function of capacitance (typical curve)



Max. RMS voltage as a function of frequency



Max. RMS current as a function of frequency



Insulation resistance as a function of ambient temperature (typical curve)

**APPLICATION NOTES**

- For X1 electromagnetic interference suppression in **standard and 3-phase across the line applications** (50 Hz/60 Hz) with a maximum mains voltage of 480 V<sub>AC</sub>
- For series impedance applications we refer to the application note: [www.vishay.com/doc?28153](http://www.vishay.com/doc?28153)
- To ensure withstanding high humidity requirements in the application it is recommended not to damage the epoxy adhesion at the leads. Therefore the leads may not be damaged or bent before soldering.
- For capacitors connected in parallel, normally the proof voltage must be reduced in function of the total parallel capacitance value.



Proof voltage as function of total parallel capacitance

- These capacitors are not intended for continuous pulse applications. For these situations, capacitors of the AC and pulse programs must be used.
- The maximum ambient temperature must not exceed 110 °C.
- Rated voltage pulse slope:  
if the pulse voltage is lower than the rated voltage, the values of the specific reference data can be multiplied by 670 V<sub>DC</sub> and divided by the applied voltage.





INSPECTION REQUIREMENTS

General Notes

Sub-clause numbers of tests and performance requirements refer to the "Sectional Specification, Publication IEC 60384-14 ed-3 and Specific Reference Data".

GROUP C INSPECTION REQUIREMENTS		
SUB-CLAUSE NUMBER AND TEST	CONDITIONS	PERFORMANCE REQUIREMENTS
<b>SUB-GROUP C1A PART OF SAMPLE OF SUB-GROUP C1</b>		
4.1 Dimensions (detail)		As specified in chapters "General Data" of this specification
Initial measurements	Capacitance Tangent of loss angle at 10 kHz for C ≤ 1 μF Tangent of loss angle at 1 kHz for C > 1 μF	
4.3 Robustness of terminations	Tensile: load 10 N; 10 s Bending: load 5 N; 4 x 90°	No visible damage
4.4 Resistance to soldering heat	No pre-drying Method: 1A Solder bath: 280 °C ± 5 °C Duration: 10 s	
<b>SUB-GROUP C1A PART OF SAMPLE OF SUB-GROUP C1</b>		
4.19 Component solvent resistance	Isopropylalcohol at room temperature Method: 2 Immersion time: 5 min ± 0.5 min Recovery time: min. 1 h, max. 2 h	
4.4.2 Final measurements	Visual examination  Capacitance  Tangent of loss angle  Insulation resistance	No visible damage Legible marking   ΔC/C  ≤ 5 % of the value measured initially  Increase of tan δ ≤ 0.008 for ≤ 1 μF Increase of tan δ ≤ 0.005 for C > 1 μF Compared to values measured initially  As specified in section "Insulation Resistance" of this specification
<b>SUB-GROUP C1B OTHER PART OF SAMPLE OF SUB-GROUP C1</b>		
Initial measurements	Capacitance Tangent of loss angle at 10 kHz for C ≤ 1 μF Tangent of loss angle at 1 kHz for C > 1 μF	
4.20 Solvent resistance of the marking	Isopropyl alcohol at room temperature Method: 1 Rubbing material: cotton wool Immersion time: 5 min ± 0.5 min	No visible damage Legible marking
4.6 Rapid change of temperature	θA = -55 °C θB = +110 °C 5 cycles Duration t = 30 min	



<b>GROUP C INSPECTION REQUIREMENTS</b>		
<b>SUB-CLAUSE NUMBER AND TEST</b>	<b>CONDITIONS</b>	<b>PERFORMANCE REQUIREMENTS</b>
<b>SUB-GROUP C1B OTHER PART OF SAMPLE OF SUB-GROUP C1</b>		
4.6.1 Inspection	Visual examination	No visible damage
4.7 Vibration	Mounting: see section "Mounting" of this specification Procedure B4: frequency range: 10 Hz to 55 Hz Amplitude: 0.75 mm or Acceleration 98 m/s <sup>2</sup> (whichever is less severe) Total duration 6 h	
4.7.2 Final inspection	Visual examination	No visible damage
4.9 Shock	Mounting: see section "Mounting" for more information Pulse shape: half sine Acceleration: 490 m/s <sup>2</sup> Duration of pulse: 11 ms	
4.9.2 Final measurements	Visual examination  Capacitance  Tangent of loss angle  Insulation resistance	No visible damage  $ \Delta C/C  \leq 5\%$ of the value measured initially  Increase of $\tan \delta \leq 0.008$ for $\leq 1 \mu\text{F}$ Increase of $\tan \delta \leq 0.005$ for $C > 1 \mu\text{F}$ Compared to values measured initially  As specified in section "Insulation Resistance" of this specification
<b>SUB-GROUP C1 COMBINED SAMPLE OF SPECIMENS OF SUB-GROUPS C1A AND C1B</b>		
4.11 Climatic sequence		
4.11.1 Initial measurements	Capacitance Measured in 4.4.2 and 4.9.2 Tangent of loss angle: measured initially in C1A and C1B	
4.11.2 Dry heat	Temperature: 110 °C	
4.11.3 Damp heat cyclic Test Db First cycle	Duration: 16 h	
4.11.4 Cold	Temperature: -55 °C	
4.11.5 Damp heat cyclic Test Db remaining cycles	Duration: 2 h	
4.11.6 Final measurements	Visual examination  Capacitance  Tangent of loss angle  Voltage proof 1900 V <sub>DC</sub> ; 1 min between terminations  Insulation resistance	No visible damage Legible marking  $ \Delta C/C  \leq 5\%$ of the value measured in 4.11.1.  Increase of $\tan \delta \leq 0.008$ for $\leq 1 \mu\text{F}$ Increase of $\tan \delta \leq 0.005$ for $C > 1 \mu\text{F}$ Compared to values measured in 4.11.1  No permanent breakdown or flash-over  $\geq 50\%$ of values specified in section "Insulation Resistance" of this specification

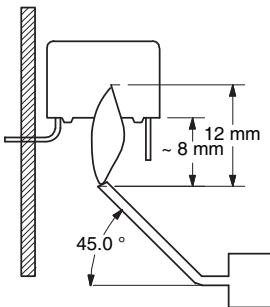

<b>GROUP C INSPECTION REQUIREMENTS</b>		
<b>SUB-CLAUSE NUMBER AND TEST</b>	<b>CONDITIONS</b>	<b>PERFORMANCE REQUIREMENTS</b>
<b>SUB-GROUP C2A</b>		
4.12A Damp heat steady state with load	RH: 85 %, temp: 85 °C, load: 400 V <sub>AC</sub> , duration: 500 h	
4.12.1A Initial measurements	Capacitance Tangent of loss angle at 1 kHz	
4.12.3A Final measurements	Visual examination	No visible damage Legible marking
	Capacitance	$ \Delta C/C  \leq 10\%$ of the value measured in 4.12.1A.
	Tangent of loss angle	Increase of $\tan \delta \leq 0.008$ Compared to values measured in 4.12.1A.
	Voltage proof 1900 V <sub>DC</sub> ; 1 min between terminations	No permanent breakdown or flash-over
	Insulation resistance	$\geq 50\%$ of values specified in section "Insulation Resistance" of this specification
<b>SUB-GROUP C3</b>		
4.13.1 Initial measurements	Capacitance Tangent of loss angle at 10 kHz for $C \leq 1 \mu\text{F}$ Tangent of loss angle at 1 kHz for $C > 1 \mu\text{F}$	
4.13 Impulse voltage	3 successive impulses, full wave, peak voltage: X1: 4.0 kV for $C \leq 1 \mu\text{F}$ X1: 4.0 kV/ $\sqrt{C}$ for $C > 1 \mu\text{F}$ Max. 24 pulses	No self healing breakdowns or flash-over
4.14 Endurance	Duration: 1000 h 1.25 x U <sub>RAC</sub> at 110 °C Once in every hour the voltage is increased to 1000 V <sub>RMS</sub> for 0.1 s via resistor of 47 $\Omega \pm 5\%$	
4.14.7 Final measurements	Visual examination	No visible damage Legible marking
	Capacitance	$ \Delta C/C  \leq 10\%$ compared to values measured in 4.13.1.
	Tangent of loss angle	Increase of $\tan \delta \leq 0.008$ for $\leq 1 \mu\text{F}$ Increase of $\tan \delta \leq 0.005$ for $C > 1 \mu\text{F}$ Compared to values measured in 4.13.1
	Voltage proof 1900 V <sub>DC</sub> ; 1 min between terminations 2380 V <sub>AC</sub> ; 1 min between terminations and case	No permanent breakdown or flash-over
	Insulation resistance	$\geq 50\%$ of values specified in section "Insulation Resistance" of this specification

<b>GROUP C INSPECTION REQUIREMENTS</b>		
<b>SUB-CLAUSE NUMBER AND TEST</b>	<b>CONDITIONS</b>	<b>PERFORMANCE REQUIREMENTS</b>
<b>SUB-GROUP C4</b>		
4.15 Charge and discharge	10 000 cycles charged to 670 V <sub>DC</sub> Discharge resistance: $R = \frac{670 V_{DC}}{1.5 \times C (dU/dt)}$	
4.15.1 Initial measurements	Capacitance Tangent of loss angle at 10 kHz for C ≤ 1 μF Tangent of loss angle at 1 kHz for C > 1 μF	
4.15.3 Final measurements	Capacitance  Tangent of loss angle  Insulation resistance	ΔC/C  ≤ 10 % compared to values measured in 4.15.1.  Increase of tan δ ≤ 0.008 for ≤ 1 μF Increase of tan δ ≤ 0.005 for C > 1 μF Compared to values measured in 4.15.1  ≥ 50 % of values specified in section "Insulation Resistance" of this specification
<b>SUB-GROUP C5</b>		
4.16 Radio frequency characteristic	Resonance frequency	≥ 0.9 times the value as specified in section "Resonant Frequency" of this specification
<b>SUB-GROUP C6</b>		
4.17 Passive flammability Class B	Bore of gas jet: Ø 0.5 mm Fuel: butane Test duration for actual volume V in mm <sup>3</sup> : V ≤ 250: 10 s 250 < V ≤ 500: 20 s 500 < V ≤ 1750: 30 s V > 1750: 60 s One flame application  	After removing test flame from capacitor, the capacitor must not continue to burn for more than 10 s. No burning particle must drop from the sample.
<b>SUB-GROUP C7</b>		
4.18 Active flammability	20 cycles of 4 kV discharges on the test capacitor connected to U <sub>RAC</sub>	The cheese cloth around the capacitors shall not burn with a flame. No electrical measurements are required.



## Disclaimer

ALL PRODUCT, PRODUCT SPECIFICATIONS AND DATA ARE SUBJECT TO CHANGE WITHOUT NOTICE TO IMPROVE RELIABILITY, FUNCTION OR DESIGN OR OTHERWISE.

Vishay Intertechnology, Inc., its affiliates, agents, and employees, and all persons acting on its or their behalf (collectively, "Vishay"), disclaim any and all liability for any errors, inaccuracies or incompleteness contained in any datasheet or in any other disclosure relating to any product.

Vishay makes no warranty, representation or guarantee regarding the suitability of the products for any particular purpose or the continuing production of any product. To the maximum extent permitted by applicable law, Vishay disclaims (i) any and all liability arising out of the application or use of any product, (ii) any and all liability, including without limitation special, consequential or incidental damages, and (iii) any and all implied warranties, including warranties of fitness for particular purpose, non-infringement and merchantability.

Statements regarding the suitability of products for certain types of applications are based on Vishay's knowledge of typical requirements that are often placed on Vishay products in generic applications. Such statements are not binding statements about the suitability of products for a particular application. It is the customer's responsibility to validate that a particular product with the properties described in the product specification is suitable for use in a particular application. Parameters provided in datasheets and/or specifications may vary in different applications and performance may vary over time. All operating parameters, including typical parameters, must be validated for each customer application by the customer's technical experts. Product specifications do not expand or otherwise modify Vishay's terms and conditions of purchase, including but not limited to the warranty expressed therein.

Except as expressly indicated in writing, Vishay products are not designed for use in medical, life-saving, or life-sustaining applications or for any other application in which the failure of the Vishay product could result in personal injury or death. Customers using or selling Vishay products not expressly indicated for use in such applications do so at their own risk. Please contact authorized Vishay personnel to obtain written terms and conditions regarding products designed for such applications.

No license, express or implied, by estoppel or otherwise, to any intellectual property rights is granted by this document or by any conduct of Vishay. Product names and markings noted herein may be trademarks of their respective owners.

## Material Category Policy

**Vishay Intertechnology, Inc. hereby certifies that all its products that are identified as RoHS-Compliant fulfill the definitions and restrictions defined under Directive 2011/65/EU of The European Parliament and of the Council of June 8, 2011 on the restriction of the use of certain hazardous substances in electrical and electronic equipment (EEE) - recast, unless otherwise specified as non-compliant.**

**Please note that some Vishay documentation may still make reference to RoHS Directive 2002/95/EC. We confirm that all the products identified as being compliant to Directive 2002/95/EC conform to Directive 2011/65/EU.**

**Vishay Intertechnology, Inc. hereby certifies that all its products that are identified as Halogen-Free follow Halogen-Free requirements as per JEDEC JS709A standards. Please note that some Vishay documentation may still make reference to the IEC 61249-2-21 definition. We confirm that all the products identified as being compliant to IEC 61249-2-21 conform to JEDEC JS709A standards.**



Компания «ЭлектроПласт» предлагает заключение долгосрочных отношений при поставках импортных электронных компонентов на взаимовыгодных условиях!

Наши преимущества:

- Оперативные поставки широкого спектра электронных компонентов отечественного и импортного производства напрямую от производителей и с крупнейших мировых складов;
- Поставка более 17-ти миллионов наименований электронных компонентов;
- Поставка сложных, дефицитных, либо снятых с производства позиций;
- Оперативные сроки поставки под заказ (от 5 рабочих дней);
- Экспресс доставка в любую точку России;
- Техническая поддержка проекта, помощь в подборе аналогов, поставка прототипов;
- Система менеджмента качества сертифицирована по Международному стандарту ISO 9001;
- Лицензия ФСБ на осуществление работ с использованием сведений, составляющих государственную тайну;
- Поставка специализированных компонентов (Xilinx, Altera, Analog Devices, Intersil, Interpoint, Microsemi, Aeroflex, Peregrine, Syfer, Eurofarad, Texas Instrument, Miteq, Cobham, E2V, MA-COM, Hittite, Mini-Circuits, General Dynamics и др.);

Помимо этого, одним из направлений компании «ЭлектроПласт» является направление «Источники питания». Мы предлагаем Вам помощь Конструкторского отдела:

- Подбор оптимального решения, техническое обоснование при выборе компонента;
- Подбор аналогов;
- Консультации по применению компонента;
- Поставка образцов и прототипов;
- Техническая поддержка проекта;
- Защита от снятия компонента с производства.



#### Как с нами связаться

**Телефон:** 8 (812) 309 58 32 (многоканальный)

**Факс:** 8 (812) 320-02-42

**Электронная почта:** [org@eplast1.ru](mailto:org@eplast1.ru)

**Адрес:** 198099, г. Санкт-Петербург, ул. Калинина, дом 2, корпус 4, литера А.