

# Series 70

## Characteristics

The Series 70 consists of special short stroke pushbuttons for use with membrane keyboards. It is particularly suited for:

- PCBs

The use of single LEDs ensures that the entire control panel is very well illuminated. The module is offered in six colours and in a round or square design.

## Functions

The Series 70 incorporates the following functions:

- Indicator
- Pushbutton
- Illuminated pushbutton

## Market segments

The EAO Series 70 is especially suited for applications in the segments:

- Machinery and Automation
- Medicinal technology
- Laboratory and measuring equipment

Please refer to the EAO website to obtain detailed information regarding this series [www.products.eao.com](http://www.products.eao.com)  
Configure a product to your exact needs and request a quotation.





<b>Overview</b>	
<b>PCB pushbuttons</b>	
Illumination element	680
Switching element without illumination	681
Switching element with illumination	682
<b>Accessories</b>	<b>683</b>
<b>Drawings</b>	<b>687</b>
<b>Technical data</b>	<b>688</b>
<b>Application guidelines</b>	<b>690</b>

01
02
03
04
10
14
17
18
19
22
31
41
44
51
56
57
61
<b>70</b>
71
82
84
92
95
96
97
99
ST

# 70 PCB pushbuttons

## Illumination element



Product can differ from the current configuration.

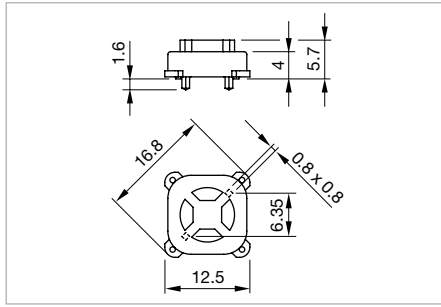

Dimensions

### Equipment consisting of (schematic overview)



**Lens**

page 684



**LED**





**Illumination element**

Each Part Number listed below includes all the black components shown in the 3D-drawing.

To obtain a complete unit, please select the red components from the pages shown.

### Additional Information

- The customer has to decide what series resistor shall be used to the LED
- Dimensions with fitted lens see details «Lens»
- Luminosity and wave length variations caused by LED manufacturing processes may cause slight differences regarding the illumination

LED colour	Forward voltage typ.	Lumi. intensity	Dom. wavelength	Terminal	Part No.	Component layout	Wiring diagram	Weight
 <p><b>Illumination element</b></p>								
Single-LED red	2.1 VDC @ 20 mA	200 mcd	625 nm	PCB	<b>70-820.2</b>	3	2	0.001 kg
Single-LED orange	2.1 VDC @ 20 mA	220 mcd	590 nm	PCB	<b>70-820.3</b>	3	2	0.001 kg
Single-LED yellow	3.3 VDC @ 30 mA	500 mcd	570 nm	PCB	<b>70-820.4</b>	3	2	0.001 kg
Single-LED green	3.5 VDC @ 20 mA	250 mcd	525 nm	PCB	<b>70-820.5</b>	3	2	0.001 kg
Single-LED blue	3.5 VDC @ 20 mA	450 mcd	470 nm	PCB	<b>70-820.6</b>	3	2	0.001 kg
Single-LED white	3.3 VDC @ 20 mA	600 mcd	x=0.29/y=0.31 nm	PCB	<b>70-820.9</b>	3	2	0.001 kg
 <p><b>Illumination element</b></p>								
Bi-colour red/green	2.0/3.2 VDC @ 20 mA	310/800 mcd	625/528 nm	PCB	<b>70-820.25</b>	3	1	0.001 kg
Bi-colour yellow/green	2.0/3.2 VDC @ 20 mA	350/750 mcd	591/528 nm	PCB	<b>70-820.45</b>	3	1	0.001 kg
 <p><b>Illumination element</b></p>								
without LED				PCB	<b>92-800.042</b>	1		0.001 kg

The component layouts you will find from page 687

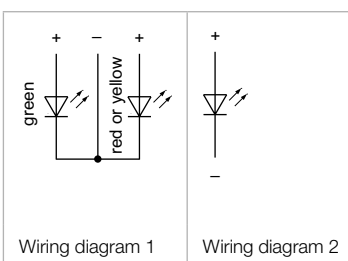

## Switching element without illumination

### Equipment consisting of (schematic overview)



**Spacing cap** [page 685](#)



**Switching element**

Each Part Number listed below includes all the black components shown in the 3D-drawing.

To obtain a complete unit, please select the red components from the pages shown.

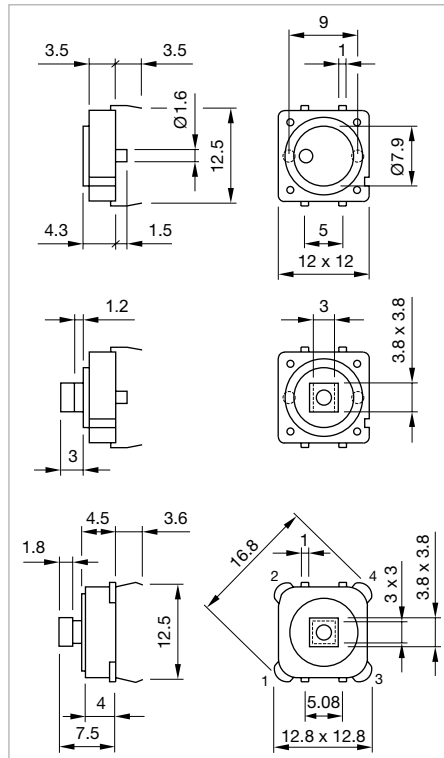



Dimensions



Product can differ from the current configuration.

### Additional Information

- Contact normally open
- Switching action momentary
- Dimensions with fitted spacing cap see details «Spacing cap»

Product attribute	Contact material	Terminal	Part No.	Component layout	Wiring diagram	Weight
 <p><b>Switching element without illumination</b></p>						
without spacing cap	Silver	PCB	<b>70-100.0</b>	2	2	0.001 kg
 <p><b>Switching element without illumination</b></p>						
with spacing cap	Silver	PCB	<b>70-101.0</b>	2	2	0.001 kg
 <p><b>Switching element without illumination</b></p>						
with spacing cap	Gold	PCB	<b>70-201.0</b>	1	1	0.001 kg

The component layouts you will find from page 687

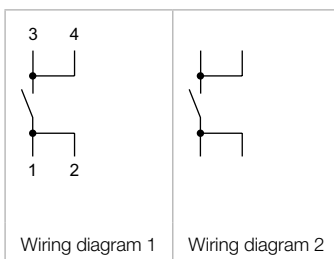

# 70 PCB pushbuttons

## Switching element with illumination



Product can differ from the current configuration.

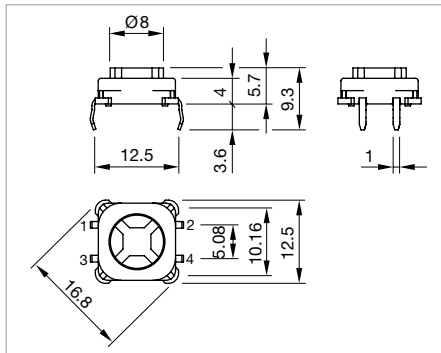

Dimensions

### Equipment consisting of (schematic overview)



**Lens**

page 684



**LED**



**Switching element**

Each Part Number listed below includes all the black components shown in the 3D-drawing.

To obtain a complete unit, please select the red components from the pages shown.

### Additional Information

- Contact normally open
- Switching action momentary
- The customer has to decide what series resistor shall be used to the LED
- Luminosity and wave length variations caused by LED manufacturing processes may cause slight differences regarding the illumination
- Dimensions with fitted lens see details «Lens»

LED colour	Forward voltage typ.	Contact material	Lumi. intensity	Dom. wavelength	Terminal	Part No.	Component layout	Wiring diagram	Weight
<h3>Switching element with illumination</h3>									
Single-LED red	2.1 VDC @ 20 mA	Gold	200 mcd	625 nm	PCB	<b>70-220.2</b>	4	3	0.001 kg
Single-LED orange	2.1 VDC @ 20 mA	Gold	220 mcd	590 nm	PCB	<b>70-220.3</b>	4	3	0.001 kg
Single-LED yellow	3.3 VDC @ 20 mA	Gold	500 mcd	570 nm	PCB	<b>70-220.4</b>	4	3	0.001 kg
Single-LED green	3.5 VDC @ 20 mA	Gold	250 mcd	525 nm	PCB	<b>70-220.5</b>	4	3	0.001 kg
Single-LED blue	3.5 VDC @ 20 mA	Gold	450 mcd	470 nm	PCB	<b>70-220.6</b>	4	3	0.001 kg
Single-LED white	3.3 VDC @ 20 mA	Gold	600 mcd	x=0.29/y=0.31 nm	PCB	<b>70-220.9</b>	4	3	0.001 kg
<h3>Switching element with illumination</h3>									
Bi-colour LED red/green	2.0/3.2 VDC @ 20 mA	Gold	310/800 mcd	625/528 nm	PCB	<b>70-220.25</b>	4	2	0.001 kg
Bi-colour LED yellow/green	2.0/3.2 VDC @ 20 mA	Gold	350/750 mcd	591/528 nm	PCB	<b>70-220.45</b>	4	2	0.001 kg
<h3>Switching element with illumination</h3>									
without LED		Gold			PCB	<b>92-851.342</b>	4	1	0.001 kg

The component layouts you will find from page 687

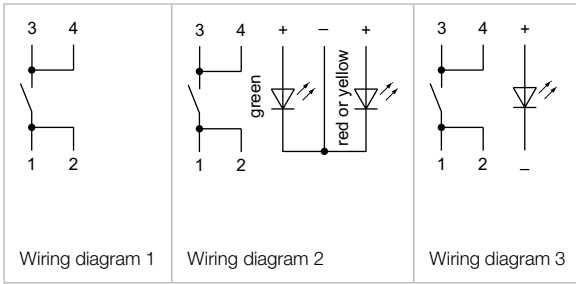



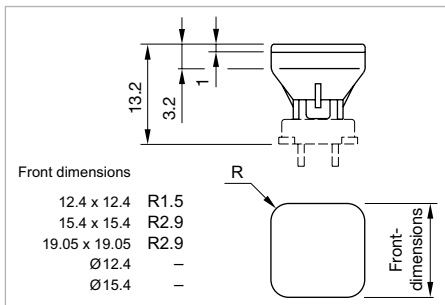

- 01
- 02
- 03
- 04
- 10
- 14
- 17
- 18
- 19
- 22
- 31
- 41
- 44
- 51
- 56
- 57
- 61
- 70**
- 71
- 82
- 84
- 92
- 95
- 96
- 97
- 99
- ST

## Front

### Lens



Dimensions

Lens	Part No.	Weight
 <p><b>Lens, Front dimension 19.05 x 19.05 mm</b></p>		
Plastic white translucent	<b>70-920.9</b>	0.001 kg
 <p><b>Lens, Front dimension 15.4 x 15.4 mm</b></p>		
Plastic red translucent	<b>70-921.2</b>	0.001 kg
Plastic orange translucent	<b>70-921.3</b>	0.001 kg
Plastic yellow translucent	<b>70-921.4</b>	0.001 kg
Plastic green translucent	<b>70-921.5</b>	0.001 kg
Plastic blue translucent	<b>70-921.6</b>	0.001 kg
Plastic white translucent	<b>70-921.9</b>	0.001 kg
 <p><b>Lens, Front dimension 12.4 x 12.4 mm</b></p>		
Plastic red translucent	<b>70-922.2</b>	0.001 kg
Plastic orange translucent	<b>70-922.3</b>	0.001 kg
Plastic yellow translucent	<b>70-922.4</b>	0.001 kg
Plastic green translucent	<b>70-922.5</b>	0.001 kg
Plastic blue translucent	<b>70-922.6</b>	0.001 kg
Plastic white translucent	<b>70-922.9</b>	0.001 kg
 <p><b>Lens, Front dimension Ø 15.4 mm</b></p>		
Plastic red translucent	<b>70-911.2</b>	0.001 kg
Plastic orange translucent	<b>70-911.3</b>	0.001 kg
Plastic yellow translucent	<b>70-911.4</b>	0.001 kg
Plastic green translucent	<b>70-911.5</b>	0.001 kg
Kunststoff weiss translucent	<b>70-911.9</b>	0.001 kg



01  
02  
03  
04  
10  
14  
17  
18  
19  
22  
31  
41  
44  
51  
56  
57  
61  
**70**  
71  
82  
84  
92  
95  
96  
97  
99  
ST

Lens	Part No.	Weight
 <b>Lens, Front dimension Ø 12.4 mm</b>		
Plastic red translucent	<b>70-912.2</b>	0.001 kg
Plastic orange translucent	<b>70-912.3</b>	0.001 kg
Plastic yellow translucent	<b>70-912.4</b>	0.001 kg
Plastic green translucent	<b>70-912.5</b>	0.001 kg
Plastic white translucent	<b>70-912.9</b>	0.001 kg

**Spacing cap**

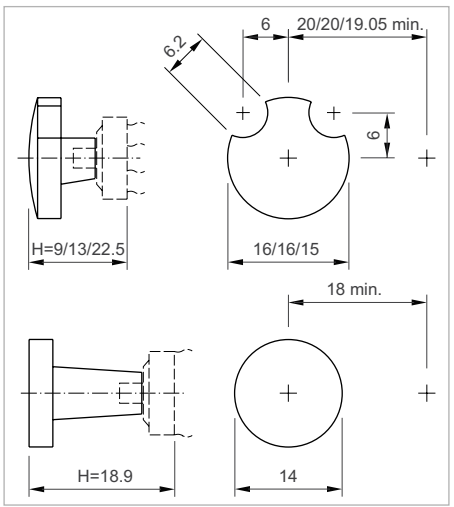

Dimensions

Product attribute	Part No.	Weight
 <b>Spacing cap</b>		
without recesses for LED, H = 18.9 mm	<b>70-901.0</b>	0.001 kg
2 recesses for LED, H = 9 mm	<b>70-910.0</b>	0.001 kg
2 recesses for LED, H = 13 mm	<b>70-911.0</b>	0.001 kg
2 recesses for LED, H = 22.5 mm	<b>70-912.0</b>	0.001 kg

## Illumination

### Single-LED, T1 Bi-Pin

#### Additional Information

- The customer has to decide what series resistor shall be used to the LED
- Luminosity and wave length variations caused by LED manufacturing processes may cause slight differences regarding the illumination

LED colour	Forward voltage typ.	Lumi. intensity	Dom. wavelength	Part No.	Weight
 <p><b>Single-LED</b></p>					
Single-LED red	2.1 VDC @ 20 mA	200 mcd	625 nm	<b>10-2602.3202L</b>	0.001 kg
Single-LED orange	2.1 VDC @ 20 mA	220 mcd	590 nm	<b>10-2602.3203L</b>	0.001 kg
Single-LED yellow	3.3 VDC @ 20 mA	500 mcd	570 nm	<b>10-2602.3204L</b>	0.001 kg
Single-LED green	3.5 VDC @ 20 mA	250 mcd	525 nm	<b>10-2602.3205L</b>	0.001 kg
Single-LED blue	3.5 VDC @ 20 mA	450 mcd	470 nm	<b>10-2602.3206L</b>	0.001 kg
Single-LED white	3.3 VDC @ 20 mA	600 mcd	x=0.29/y=0.31 nm	<b>10-2602.3209L</b>	0.001 kg

### Bi-colour-LED, T1 Bi-Pin

#### Additional Information

- The customer has to decide what series resistor shall be used to the LED
- Luminosity and wave length variations caused by LED manufacturing processes may cause slight differences regarding the illumination

LED colour	Forward voltage typ.	Lumi. intensity	Dom. wavelength	Part No.	Weight
 <p><b>Bi-colour-LED</b></p>					
Bi-colour LED red/green	2.0/3.2 VDC @ 20 mA	310/800 mcd	625/528 nm	<b>10-2603.308AL</b>	0.001 kg
Bi-colour LED yellow/green	2.0/3.2 VDC @ 20 mA	350/750 mcd	591/528 nm	<b>10-2603.308CL</b>	0.001 kg

## Drawings

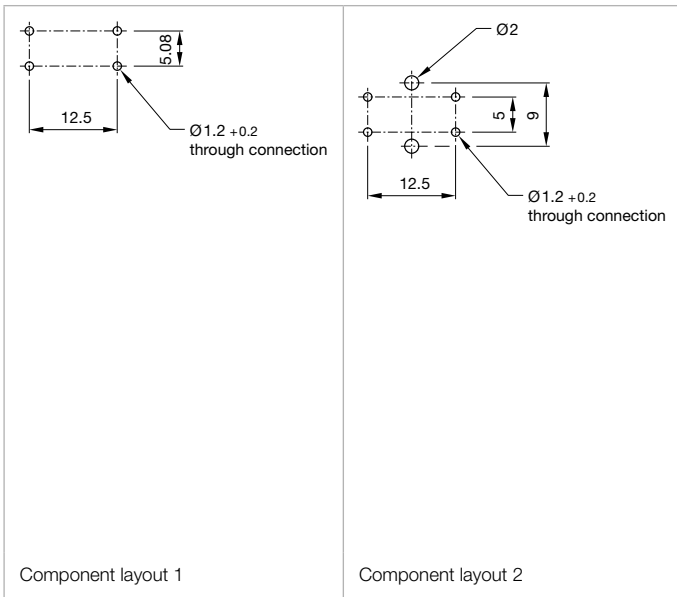

### Single-LED

Drilling plan (element side)

- B Holes for LED
- C Holes for centering pins

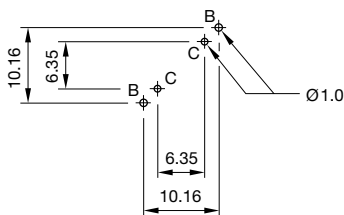

Component layout 3

### Bi-colour-LED

Drilling plan (element side)

- B Holes for Bi-colour LED:
- BA1 (green) + BA2 (yellow or red) = Anodes, BC = Cathode
- C Holes for centering pins

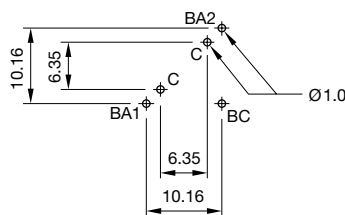

### Single-LED

Drilling plan (element side)

- B Holes for LED
- C Holes for contact pins
- Pad max.  $\text{Ø}2.5$  mm
- Through-connection recommended

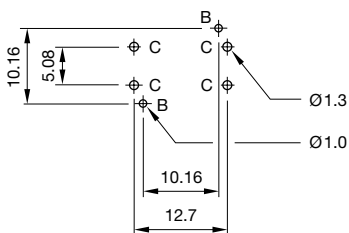

Component layout 4

### Bi-colour-LED

Drilling plan (element side)

- B Holes for Bi-colour-LED:
- BA1 (green) + BA2 (yellow or red) = Anodes, BK = Cathode
- C Holes for contact pins
- Pad max.  $\text{Ø}2.5$  mm
- Through-connection recommended

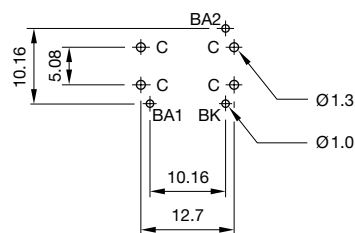

# 70 Technical data

## Switching element illuminated

### Switching system

Short-travel switching system with two independent contact points and tactile operation. Guarantees reliable switching even of very light loads.  
1 normally open contact

### Material

#### Material of contact

Gold (Au)

#### Switching element

Thermoplastic Polyester (PET, PBT) and Polyacetale (POM)

### Mechanical characteristics

#### Actuating force

with overlay foil 4 N  $\pm$ 1,5 N  
Max. actuating force > 50 N, as per DIN 42115

#### Actuating travel

0.4 mm

#### Rebound time

$\leq$  1 ms

#### Resistance to heat of soldering

260 °C, 5 s, as per IEC 60068-2-20

#### Mechanical lifetime

> 5 million operations

### Electrical characteristics

#### Contact resistance

Starting value (initial)  $\leq$  100 m $\Omega$ , as per IEC 60512-2-2b

#### Isolation resistance

$\geq$  1000 M $\Omega$

#### Contact resistance

$\leq$  100 m $\Omega$

as per 500 000 cycles of operation at 12 VDC, 5 mA resistive load  $\leq$  200 m $\Omega$

#### Electrical life

$\geq$  500 000 operations at 42 VDC, 50 mA, as per IEC 60512-5-9c  
When attention is paid to the direction of current flow from terminal 3/4 to 1/2 the electrical life can be prolonged.

#### Switch rating

max. 2 VA (resistive load)

#### Switch rating

Switching voltage VDC/VAC	min. 50 mV	max. 42 V
Switching current VDC/VAC	min. 10 $\mu$ A	max. 100 mA
Power rating	max. 2 W	

#### Electric strength

500 VAC, 50 Hz, 1 min, as per IEC 60512-2-4a

### Environmental conditions

#### Storage temperature

-40 °C ... +85 °C

#### Operating temperature

-25 °C ... +70 °C

## Switching element non-illuminated Part No. 70-100.0 and 70-101.0

### Switching system

Short-travel switching system with two independent contact points and tactile operation. Guarantees reliable switching even of very light loads.  
1 normally open contact

### Material

#### Material of contact

Silver (Ag)

### Mechanical characteristics

#### Actuating force

with overlay foil 5 N  $\pm$ 2 N  
Max. actuating force >50 N, as per DIN 42115

#### Actuating travel

0.3 mm

#### Rebound time

$\leq$  5ms

#### Mechanical lifetime

> 1 million operations

**Electrical characteristics**
**Isolation resistance**

≥ 50 MΩ

**Contact resistance**

≤ 100 mΩ

as per 500 000 cycles of operation at 12 VDC, 5 mA resistive load ≤ 200 mΩ

**Electrical life**

at 5 VDC, 1 mA > 1 million operations

at 24 VDC, 1 mA > 100 000 operations

**Switch rating**

≤ 1 VA (resistive load)

**Switch rating**

≤ 24 VDC, ≤ 50 mA

**Electric strength**

250 VAC for 1 min.

**Environmental conditions**
**Storage temperature**

-30 °C ... +85 °C

**Operating temperature**

-20 °C ... +70 °C

**Switching element non-illuminated Part No. 70-201.0**
**Switching system**

Short-travel switching system with two independent contact points and tactile operation. Guarantees reliable switching even of very light loads.

1 normally open contact

**Material**
**Material of contact**

Gold (Au)

**Switching element**

Thermoplastic Polyester (PET, PBT) and Polyacetale (POM)

**Mechanical characteristics**
**Actuating force**

with overlay foil 2.1 N ±0.2 N

Max. actuating force > 50 N, as per DIN 42115

**Actuating travel**

max. 0.5 mm

**Rebound time**

≤ 1 ms

**Resistance to heat of soldering**

260 °C, 5 s, as per IEC 60068-2-20

**Mechanical lifetime**

> 5 million operations

**Front protection**

front with overlay foil IP 65

*EAO reserves the right to alter specifications without further notice.*

**Electrical characteristics**
**Contact resistance**

Starting value (initial) ≤ 100 mΩ, as per IEC 60512-2-2b

**Isolation resistance**

≥ 1000 MΩ

**Contact resistance**

≤ 100 mΩ

as per 500 000 cycles of operation at 12 VDC, 5 mA resistive load ≤ 200 mΩ

**Electrical life**

≥ 500 000 operations at 42 VDC, 50 mA, as per IEC 60512-5-9c  
When attention is paid to the direction of current flow from terminal ¾ to ½ the electrical life can be prolonged.

**Switch rating**

max. 42 V, 50 mA

min. 50 mV, 10 µA

**Switch rating**

Switching voltage VDC/VAC	min. 50 mV	max. 42 V
---------------------------	------------	-----------

Switching current VDC/VAC	min. 10 mA	max. 100 mA
---------------------------	------------	-------------

Switch rating	max. 2 W
---------------	----------

**Electric strength**

500 VAC, 50 Hz, 1 min, as per IEC 60512-2-4a

**Environmental conditions**
**Storage temperature**

-40 °C ... +85 °C

**Operating temperature**

-25 °C ... +70 °C

# 70 Application guidelines

## Suppressor circuits

When switching inductive loads such as relays, DC motors, and DC solenoids, it is always important to absorb surges (e.g. with a diode) to protect the contacts. When these inductive loads are switched off, a counter emf can severely damage switch contacts and greatly shorten lifetime.

Fig. 1 shows an inductive load with a free-wheeling diode connected in parallel. This free-wheeling diode provides a path for the inductor current to flow when the current is interrupted by the switch. Without this free-wheeling diode, the voltage across the coil will be limited only by dielectric breakdown voltages of the circuit or parasitic elements of the coil. This voltage can be kilovolts in amplitude even when nominal circuit voltages are low (e.g. 12VDC) see Fig. 2.

The free-wheeling diode should be chosen so that the reverse breakdown voltage is greater than the voltage driving the inductive load. The DC blocking voltage ( $V_R$ ) of the free-wheeling diode can be found in the datasheet of a diode. The forward current should be equal or greater than the maximum current flowing through the load.

**To get an efficient protection, the free-wheeling diode must be connected as close as possible to the inductive load!**

Switching with inductive load  
Fig. 1

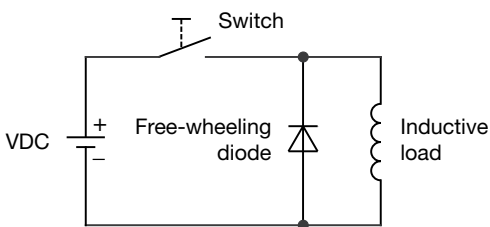

Counter EMF  
over load without free-wheeling diode  
Fig. 2

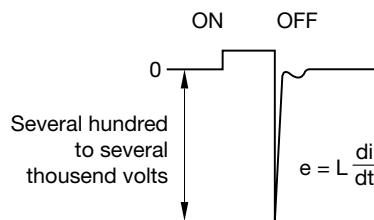



Компания «ЭлектроПласт» предлагает заключение долгосрочных отношений при поставках импортных электронных компонентов на взаимовыгодных условиях!

Наши преимущества:

- Оперативные поставки широкого спектра электронных компонентов отечественного и импортного производства напрямую от производителей и с крупнейших мировых складов;
- Поставка более 17-ти миллионов наименований электронных компонентов;
- Поставка сложных, дефицитных, либо снятых с производства позиций;
- Оперативные сроки поставки под заказ (от 5 рабочих дней);
- Экспресс доставка в любую точку России;
- Техническая поддержка проекта, помощь в подборе аналогов, поставка прототипов;
- Система менеджмента качества сертифицирована по Международному стандарту ISO 9001;
- Лицензия ФСБ на осуществление работ с использованием сведений, составляющих государственную тайну;
- Поставка специализированных компонентов (Xilinx, Altera, Analog Devices, Intersil, Interpoint, Microsemi, Aeroflex, Peregrine, Syfer, Eurofarad, Texas Instrument, Miteq, Cobham, E2V, MA-COM, Hittite, Mini-Circuits, General Dynamics и др.);

Помимо этого, одним из направлений компании «ЭлектроПласт» является направление «Источники питания». Мы предлагаем Вам помощь Конструкторского отдела:

- Подбор оптимального решения, техническое обоснование при выборе компонента;
- Подбор аналогов;
- Консультации по применению компонента;
- Поставка образцов и прототипов;
- Техническая поддержка проекта;
- Защита от снятия компонента с производства.



#### Как с нами связаться

**Телефон:** 8 (812) 309 58 32 (многоканальный)

**Факс:** 8 (812) 320-02-42

**Электронная почта:** [org@eplast1.ru](mailto:org@eplast1.ru)

**Адрес:** 198099, г. Санкт-Петербург, ул. Калинина, дом 2, корпус 4, литера А.