

Standard Models (Power Supply: 100 to 120 VAC)

| | | Indication method | | No indication | |
|---------------------------|---------------------------|----------------------------|-----------|---------------|------------------|
| | | | | ON/OFF | Proportional (P) |
| Control mode | | Output | | Relay | |
| Input | Thermocouple | Output | Relay | | |
| Input/standard scale (°C) | K (CA) Chromel vs. alumel | 0 to 200 | E5C2-R20K | E5C2-R40K | |
| | | 0 to 300 | E5C2-R20K | E5C2-R40K | |
| | | 0 to 400 | E5C2-R20K | E5C2-R40K | |
| | | 0 to 600 | E5C2-R20K | E5C2-R40K | |
| | | 0 to 800 | E5C2-R20K | E5C2-R40K | |
| | | 0 to 1,000 | E5C2-R20K | E5C2-R40K | |
| | | 0 to 1,200 | E5C2-R20K | E5C2-R40K | |
| | | J (IC) Iron vs. constantan | 0 to 200 | E5C2-R20J | E5C2-R40J |
| | 0 to 300 | E5C2-R20J | E5C2-R40J | | |
| | 0 to 400 | E5C2-R20J | E5C2-R40J | | |

Note: Ask your OMRON representative about models with 200 to 240 VAC power supply.

| | | Indication method | | No indication | | |
|---------------------------|---------------------------------------|-------------------|---------------------------|---------------|------------------|-----|
| | | | | ON/OFF | Proportional (P) | |
| Control mode | | Output | | Relay | | |
| Input | Resistance Thermometer | Output | Relay | | | |
| Input/standard scale (°C) | Platinum resistance thermometer Pt100 | -50 to 50 | E5C2-R20P-D | E5C2-R40P-D | | |
| | | -20 to 80 | E5C2-R20P-D | E5C2-R40P-D | | |
| | | 0 to 50 | E5C2-R20P-D | E5C2-R40P-D | | |
| | | 0 to 100 | E5C2-R20P-D | E5C2-R40P-D | | |
| | | 0 to 200 | E5C2-R20P-D | E5C2-R40P-D | | |
| | | 0 to 300 | E5C2-R20P-D | E5C2-R40P-D | | |
| | | 0 to 400 | E5C2-R20P-D | E5C2-R40P-D | | |
| | | Thermistor | THE (replaceable element) | -50 to 50 | E5C2-R20G | --- |
| | 0 to 100 | E5C2-R20G | --- | | | |
| | 50 to 150 | E5C2-R20G | --- | | | |
| | 100 to 200 | E5C2-R20G | --- | | | |
| | 150 to 300 | E5C2-R20G | --- | | | |

Accessories (Order Separately)

Sockets

| Name | Model |
|--|-----------|
| Front Connecting Socket | P2CF-08 |
| Back Connecting Socket | P3G-08 |
| Front Connecting Socket with Finger Protection | P2CF-08-E |
| Protective Cover (for finger protection) | Y92A-48G |

Protective Cover

| Type | Model |
|-----------------------|----------|
| Hard Protective Cover | Y92A-48B |

Specifications

Ratings

| | |
|-------------------------------|---|
| Supply voltage | 100 to 120 VAC 50/60 Hz 200 to 240 VAC 50/60 Hz (See note 1.) |
| Operating voltage range | 90% to 110% of rated supply voltage |
| Power consumption | Approx. 3 VA |
| Input | Thermocouple (with sensor burnout detection circuit), platinum resistance thermometer, or thermistor with replaceable element |
| Control method | ON/OFF or proportional control |
| Setting method | Analog setting |
| Indication method | No indication |
| Control output | Relay output: SPDT, 3 A at 250 VAC, resistive load (switching capacity: 330 VA) |
| Ambient operating temperature | -10°C to 55°C (with no icing or condensation) |
| Ambient operating humidity | 45% to 85% |

- Note: 1. Specify either 100/110/120 VAC or 200/220/240 VAC when ordering.
2. Do not use an inverter output as the power supply. (Refer to Safety Precautions for All Temperature Controllers.)

Characteristics

| | |
|-----------------------------|--|
| Setting accuracy | ±2% FS max. |
| Hysteresis | Approx. 0.5% FS (fixed) |
| Proportional band | 3% FS (fixed) |
| Control period | Approx. 20 s |
| Reset range | 5 ±1% FS min. (See note 1.) |
| Insulation resistance | 20 MΩ min. (at 500 VDC) |
| Dielectric strength | 2,000 VAC, 50/60 Hz for 1 min between charged terminals and uncharged metallic parts |
| Vibration resistance | Malfunction: 10 to 55 Hz, 0.15-mm single amplitude for 10 min each in X, Y, and Z directions Destruction: 16.7 Hz, 2-mm double amplitude for 2 hrs each in X, Y, and Z directions |
| Shock resistance | Malfunction: 147 m/s ² , 3 times each in 6 directions Destruction: 294 m/s ² , 3 times each in 6 directions |
| Life expectancy | Electrical: 100,000 operations min. (3 A at 110 VAC, resistive load) |
| Weight | Approx. 200 g (with flush-mounting adapter) |
| Degree of protection | Front panel: IEC standard IP40 (See note 2.) Terminals: IEC standard IP00 |
| Applicable Socket | P2CF-08 (order separately), P3G-08 (order separately) |
| Applicable Protective Cover | Y92A-48B (order separately) |

- Note: 1. No reset function is incorporated by any E5C2 model with ON/OFF control. The reset function is used to correct offset for proportional control. If there is an offset below the set value, turn the reset adjustment clockwise.
2. A special Watertight Cover is used to achieve this degree of protection (IP66, NEMA4). Refer to Y92A-□□□.

Connections

Connecting the Input

- Connect a thermocouple, the E52-THE□ Thermistor (replaceable element) or a platinum resistance thermometer to terminals 1 (positive) and 2 (negative) on the E5C2 as shown in the following illustration.

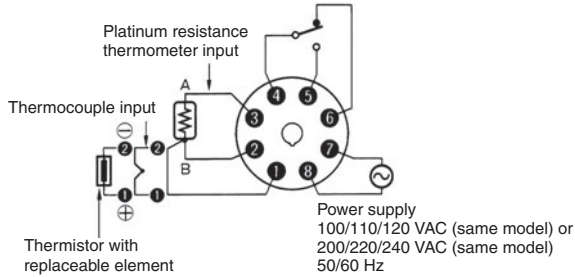

- On the E52-□□1D, the lead wires are thermocouple element wires, making them difficult to solder because solder will not stick to them easily. Remove the crimp terminal and polish the ends before attempting to solder them.

Output

- If the load circuit is a heating control system, be sure to connect the load to terminals 4 and 5. If the load circuit is a cooling control system, be sure to connect the load to terminals 4 and 6.
- We recommend using an external relay to extend the electrical life of internal relays when driving a large capacity load. This is particularly important when the output relay is switched frequently (e.g., with proportional control).

Power Supply

- If a single power supply is used for the E5C2 and the load, the supply voltage of the power supply may vary greatly when the load is open or closed if the capacity of the power supply is not large enough. Make sure that the capacity of the power supply is large enough so that the supply voltage range will be always from 90% to 110% of the rated supply voltage.
- The E5C2 operates at either 50 or 60 Hz.
- Different models must be order for 100 to 120 VAC and 200 to 240 VAC.

Nomenclature

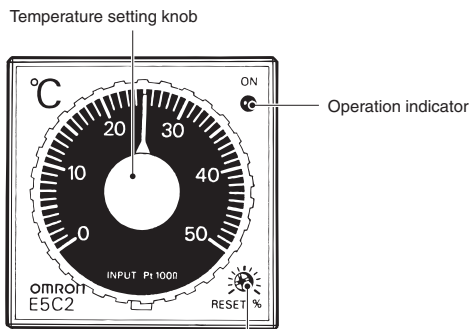

RESET adjustment shaft
No reset function is incorporated by any E5C2 model with ON/OFF control.

Operation Indicator

| Indicator | Output | |
|-----------|-----------------------|----------------------|
| | NO contacts (4 and 5) | NC contacts (4 to 6) |
| Red Lit | ON | OFF |
| Not lit | OFF | ON |

Dimensions

Note: All units are in millimeters unless otherwise indicated.

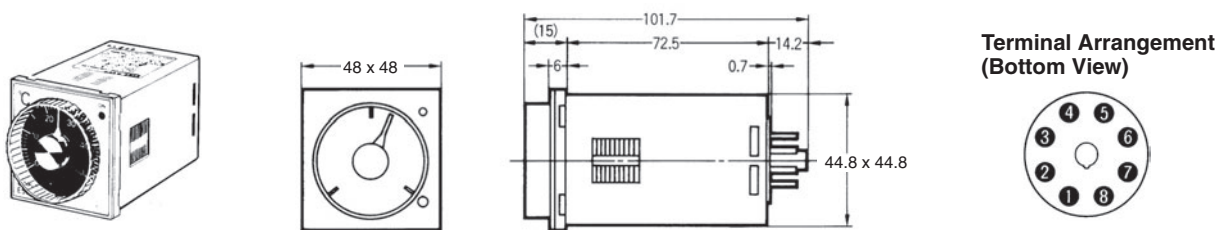

Dimensions with Flush-mounting Adapter (Accessory), and Back Connecting Socket (Sold Separately)

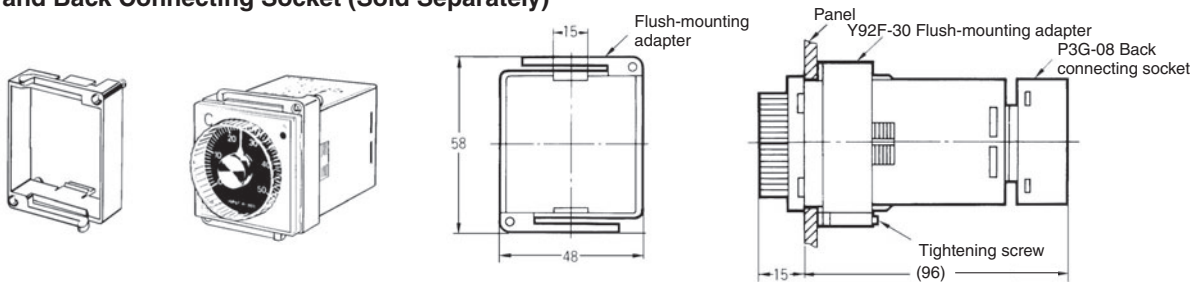

Panel Cutout

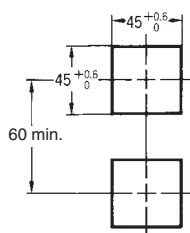

Side-by-side Mounting of N Controllers

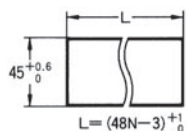

| Qty. | 2 | 3 | 4 | 5 | 6 |
|------|-------------------------------|--------------------------------|--------------------------------|--------------------------------|--------------------------------|
| L | 93 ⁺¹ ₀ | 141 ⁺¹ ₀ | 189 ⁺¹ ₀ | 237 ⁺¹ ₀ | 285 ⁺¹ ₀ |

- Note: 1. Recommended panel thickness is 1 to 4 mm.
- 2. Close side-by-side mounting is possible (in a single direction).

Accessories (Order Separately)

Connection Sockets

P2CF-08 Front Connecting Socket

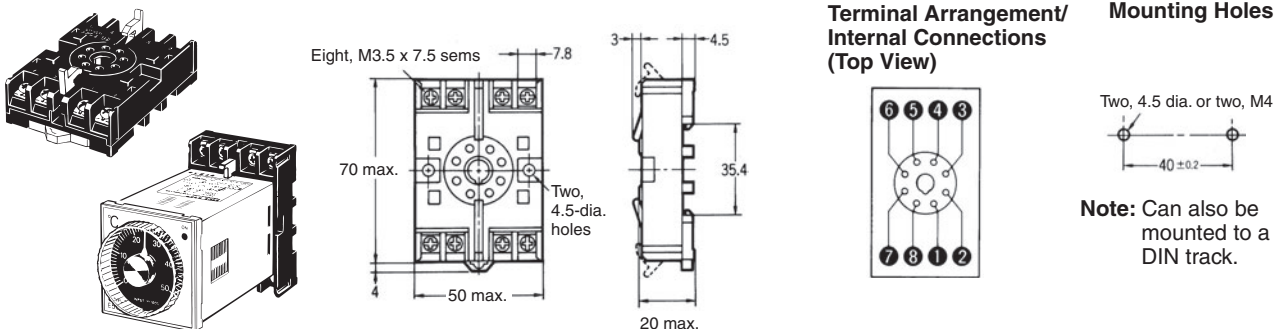

Note: A finger-protection model (P2CF-08-E) is also available.

P3G-08 Back Connecting Socket (for Flush Mounting)

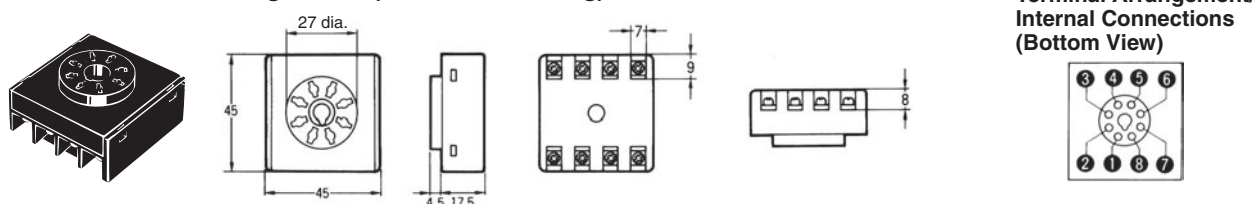

Note: A Protective Cover for finger protection (Y92A-48G) is also available.

Hard Protective Cover

A Hard Protective Cover (Y92A-48B) is available. It can be used in the following cases.

- To protect the setting section, against dust and dirt
- To prevent accidentally changing settings by touching the front of the Controller.
- To protect the Controller from water drips

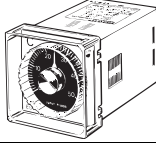
| | |
|------------|---|
| Appearance |  |
| Model | Y92A-48B |

Applicable Thermistor

Connect a Thermistor with a replaceable element (E52-THE5A, E52-THE6D, or E52-THE6F) to the E5C2-R20G. Refer to E52 for details.

Safety Precautions

Refer to *Safety Precautions for All Temperature Controllers*.

■ Correct Use

Mounting

Track Mounting (E5C2 with P2CF-08)

When mounting two or more E5C2 models with track-mounting sockets, leave a space of approximately 20 mm on both sides of the sockets where hooks are located.

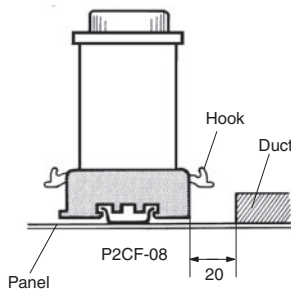

Flush Mounting

Insert E5C2 into the square hole of the panel and insert an adapter from the back so that there will be no space between E5C2 and the panel. Then, secure the E5C2 with a screw.

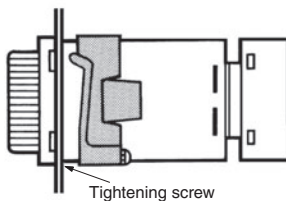

The P3G-08 can be wired in the same way as the P2CF-08.

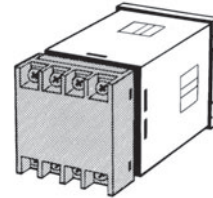

Dismounting

If flush mounted, loosen the screw of the adapter and disengage the hooks for dismounting.

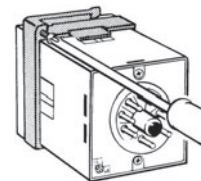

Temperature Setting

Do not turn the temperature setting knob of the E5C2 with excessive force, otherwise the stopper of the knob may break.

Others

- Do not remove the housing of the E5C2, otherwise the housing may break.
- To clean the surface of the E5C2, use a soft cloth wet with neutral detergent or alcohol. Do not use any organic solvent, such as paint thinner or benzene, strong acid or strong alkali to clean the surface of the E5C2, otherwise the surface of the E5C2 will become damaged.

ALL DIMENSIONS SHOWN ARE IN MILLIMETERS.

To convert millimeters into inches, multiply by 0.03937. To convert grams into ounces, multiply by 0.03527.

In the interest of product improvement, specifications are subject to change without notice.

Read and Understand This Catalog

Please read and understand this catalog before purchasing the products. Please consult your OMRON representative if you have any questions or comments.

Warranty and Limitations of Liability

WARRANTY

OMRON's exclusive warranty is that the products are free from defects in materials and workmanship for a period of one year (or other period if specified) from date of sale by OMRON.

OMRON MAKES NO WARRANTY OR REPRESENTATION, EXPRESS OR IMPLIED, REGARDING NON-INFRINGEMENT, MERCHANTABILITY, OR FITNESS FOR PARTICULAR PURPOSE OF THE PRODUCTS. ANY BUYER OR USER ACKNOWLEDGES THAT THE BUYER OR USER ALONE HAS DETERMINED THAT THE PRODUCTS WILL SUITABLY MEET THE REQUIREMENTS OF THEIR INTENDED USE. OMRON DISCLAIMS ALL OTHER WARRANTIES, EXPRESS OR IMPLIED.

LIMITATIONS OF LIABILITY

OMRON SHALL NOT BE RESPONSIBLE FOR SPECIAL, INDIRECT, OR CONSEQUENTIAL DAMAGES, LOSS OF PROFITS OR COMMERCIAL LOSS IN ANY WAY CONNECTED WITH THE PRODUCTS, WHETHER SUCH CLAIM IS BASED ON CONTRACT, WARRANTY, NEGLIGENCE, OR STRICT LIABILITY.

In no event shall the responsibility of OMRON for any act exceed the individual price of the product on which liability is asserted.

IN NO EVENT SHALL OMRON BE RESPONSIBLE FOR WARRANTY, REPAIR, OR OTHER CLAIMS REGARDING THE PRODUCTS UNLESS OMRON'S ANALYSIS CONFIRMS THAT THE PRODUCTS WERE PROPERLY HANDLED, STORED, INSTALLED, AND MAINTAINED AND NOT SUBJECT TO CONTAMINATION, ABUSE, MISUSE, OR INAPPROPRIATE MODIFICATION OR REPAIR.

Application Considerations

SUITABILITY FOR USE

OMRON shall not be responsible for conformity with any standards, codes, or regulations that apply to the combination of products in the customer's application or use of the products.

At the customer's request, OMRON will provide applicable third party certification documents identifying ratings and limitations of use that apply to the products. This information by itself is not sufficient for a complete determination of the suitability of the products in combination with the end product, machine, system, or other application or use.

The following are some examples of applications for which particular attention must be given. This is not intended to be an exhaustive list of all possible uses of the products, nor is it intended to imply that the uses listed may be suitable for the products:

- Outdoor use, uses involving potential chemical contamination or electrical interference, or conditions or uses not described in this catalog.
- Nuclear energy control systems, combustion systems, railroad systems, aviation systems, medical equipment, amusement machines, vehicles, safety equipment, and installations subject to separate industry or government regulations.
- Systems, machines, and equipment that could present a risk to life or property.

Please know and observe all prohibitions of use applicable to the products.

NEVER USE THE PRODUCTS FOR AN APPLICATION INVOLVING SERIOUS RISK TO LIFE OR PROPERTY WITHOUT ENSURING THAT THE SYSTEM AS A WHOLE HAS BEEN DESIGNED TO ADDRESS THE RISKS, AND THAT THE OMRON PRODUCTS ARE PROPERLY RATED AND INSTALLED FOR THE INTENDED USE WITHIN THE OVERALL EQUIPMENT OR SYSTEM.

PROGRAMMABLE PRODUCTS

OMRON shall not be responsible for the user's programming of a programmable product, or any consequence thereof.

Disclaimers

CHANGE IN SPECIFICATIONS

Product specifications and accessories may be changed at any time based on improvements and other reasons.

It is our practice to change model numbers when published ratings or features are changed, or when significant construction changes are made. However, some specifications of the products may be changed without any notice. When in doubt, special model numbers may be assigned to fix or establish key specifications for your application on your request. Please consult with your OMRON representative at any time to confirm actual specifications of purchased products.

DIMENSIONS AND WEIGHTS

Dimensions and weights are nominal and are not to be used for manufacturing purposes, even when tolerances are shown.

PERFORMANCE DATA

Performance data given in this catalog is provided as a guide for the user in determining suitability and does not constitute a warranty. It may represent the result of OMRON's test conditions, and the users must correlate it to actual application requirements. Actual performance is subject to the OMRON Warranty and Limitations of Liability.

ERRORS AND OMISSIONS

The information in this document has been carefully checked and is believed to be accurate; however, no responsibility is assumed for clerical, typographical, or proofreading errors, or omissions.

2011.4

In the interest of product improvement, specifications are subject to change without notice.

OMRON Corporation
Industrial Automation Company

<http://www.ia.omron.com/>

(c)Copyright OMRON Corporation 2011 All Right Reserved.



Компания «ЭлектроПласт» предлагает заключение долгосрочных отношений при поставках импортных электронных компонентов на взаимовыгодных условиях!

Наши преимущества:

- Оперативные поставки широкого спектра электронных компонентов отечественного и импортного производства напрямую от производителей и с крупнейших мировых складов;
- Поставка более 17-ти миллионов наименований электронных компонентов;
- Поставка сложных, дефицитных, либо снятых с производства позиций;
- Оперативные сроки поставки под заказ (от 5 рабочих дней);
- Экспресс доставка в любую точку России;
- Техническая поддержка проекта, помощь в подборе аналогов, поставка прототипов;
- Система менеджмента качества сертифицирована по Международному стандарту ISO 9001;
- Лицензия ФСБ на осуществление работ с использованием сведений, составляющих государственную тайну;
- Поставка специализированных компонентов (Xilinx, Altera, Analog Devices, Intersil, Interpoint, Microsemi, Aeroflex, Peregrine, Syfer, Eurofarad, Texas Instrument, Miteq, Cobham, E2V, MA-COM, Hittite, Mini-Circuits, General Dynamics и др.);

Помимо этого, одним из направлений компании «ЭлектроПласт» является направление «Источники питания». Мы предлагаем Вам помощь Конструкторского отдела:

- Подбор оптимального решения, техническое обоснование при выборе компонента;
- Подбор аналогов;
- Консультации по применению компонента;
- Поставка образцов и прототипов;
- Техническая поддержка проекта;
- Защита от снятия компонента с производства.



Как с нами связаться

Телефон: 8 (812) 309 58 32 (многоканальный)

Факс: 8 (812) 320-02-42

Электронная почта: org@eplast1.ru

Адрес: 198099, г. Санкт-Петербург, ул. Калинина, дом 2, корпус 4, литера А.