

To search for a part number use "CTRL F"  
or click on binocular icon above.

# Table of Contents

[Click here for Part Number Index and locator .....](#)

Introduction .....	2
Magnetic Properties of Fair-Rite Materials .....	4
Fair-Rite Materials .....	6
<b>Board Components</b>	
EMI Suppression Beads .....	24
Beads on Leads .....	29
SM Beads .....	41
Chip Beads .....	50
PC Beads .....	74
Wound Beads .....	78
Multi-Aperture Cores .....	84
<b>Engineering Kits</b> .....	92
<b>Cable Components</b>	
Round Cable EMI Suppression Cores .....	94
Split Round Cable EMI Suppression Cores .....	98
Round Cable Snap-its .....	102
Flat Cable EMI Suppression Cores .....	108
Flat Cable Snap-its .....	116
Miscellaneous Suppression Cores .....	118
Connector Suppression Plates .....	120
Tiles .....	125
<b>Inductive Components</b>	
Open Magnetic Circuit	
Rods .....	129
RFID .....	132
Tack Bobbin Cores .....	133
Bobbins .....	134
Closed Magnetic Circuit	
Toroids .....	136
Pot Cores .....	142
E & I Cores .....	146
ETD Cores .....	150
U Cores .....	152
PQ Cores .....	154
EP Cores .....	156
85 Material Toroids .....	158
<b>References</b>	
Reference Tables .....	159
Soft Ferrite References .....	160
Glossary of Terms .....	162
Magnetic Design Formulas .....	163
Wire Table of Copper Magnet Wire .....	164
<b>Technical Articles</b>	
The Effect of Direct Current on the Inductance of a Ferrite Core .....	165
Use of Ferrites in Broadband Transformers .....	170
How to Choose Ferrite Components for EMI Suppression .....	174
Ferrite Tile Absorbers for EMC Test Chamber Applications .....	183
<b>Numerical Index</b> .....	186

**Copyright © 2001 by Fair-Rite Products Corp.**

*All rights reserved. No part of the contents of this book may be published or transmitted in any form or by any means without the expressed written permission of the publisher.*

# Introduction

## History

The history of magnetism began with the discovery of the properties of a mineral called magnetite ( $\text{Fe}_3\text{O}_4$ ). The most plentiful deposits were found in the district of Magnesia in Asia Minor (hence the mineral's name) where it was observed, centuries before the birth of Christ, that these naturally occurring stones would attract iron. Later on it found application in the lodestone of early navigators. In 1600 William Gilbert published *De Magnete*, the first scientific study on magnetism. In 1819 Hans Christian Oersted observed that an electric current in a wire affected a magnetic compass needle, thus with later contributions by Faraday, Maxwell, Hertz and others, the new science of electromagnetism came into being.

Even though the existence of naturally occurring magnetite, a weak type of hard ferrite, had been known since antiquity, producing an analogous soft magnetic material in the laboratory proved elusive. Research on magnetic oxides was going on concurrently during the 1930's, primarily in Japan and the Netherlands. However, it was not until 1945 that J. L. Snoek of the Philips' Research Laboratories in the Netherlands succeeded in producing a soft ferrite material for commercial applications.

Fair-Rite Products Corp. was not far behind in the manufacture and sale of soft ferrites for use in the electronics industry. It was formed in 1952 and officially started operations in 1953. The ensuing years have seen a rather crude product, which was available in only a few shapes and materials, develop into a major line of ferrite components for inductive devices, produced in many core configurations with a wide selection of materials. The application of ferrites in EMI suppression as shield beads and broadband chokes, where an effective resistive impedance is produced at high frequencies, has grown so fast in the last decade, that their use as EMI suppressors is limited only by the imagination of the end user.

## Soft Ferrites

The single most important characteristic of soft ferrites, as compared to other magnetic materials, is the high volume resistivity exhibited in the monolithic form. Since eddy current losses are inversely proportional to resistivity and these losses increase with the square of the frequency, high resistivity becomes an essential factor in magnetic materials intended for high frequency operation. The magnetic properties of ferrite components are isotropic, and by employing various pressing, injection molding, and/or grinding techniques, a wide range of complex shapes can be formed. There is no other class of magnetic material that can match soft ferrites in performance, cost and volumetric efficiency, over the range from audio frequencies to above 500 MHz.

During the last 50 years the basic constituents of ferrites have changed little, but purity of raw materials and process control have improved dramatically. Ferrites are ceramic materials with the general chemical formula  $\text{MO}\cdot\text{Fe}_2\text{O}_3$ , where MO is one or more divalent metal oxides blended with 48 to 60 mole percent of iron oxide. Fair-Rite manufactures three broad groups of soft ferrite materials:

Manganese zinc (Fair-Rite 31, 33, 73, 75, 76, 77 and 78 material)

Nickel zinc (Fair-Rite 42, 43, 44, 51, 61, 67 and 68 material)

Manganese (Fair-Rite 85 material)

Manganese zinc ferrites are completely vitrified and have very low porosity. They have the highest permeabilities and exhibit volume resistivities ranging from one hundred to several thousand ohm-centimeter. Manganese zinc ferrite components are used in tuned circuits and magnetic power designs from the low kilohertz range into the broadcast spectrum. These ferrites have a linear expansion coefficient of approximately 10 ppm/°C.

The nickel zinc ferrites vary in porosity, and frequently contain oxides of other metals, such as those of magnesium, manganese, copper or cobalt. Volume resistivities range from several kilohm-centimeter to tens of megohm-centimeter. In general, they are used at higher frequencies (above 1 MHz), and are suitable for low flux density applications. Nickel zinc ferrites have a linear expansion coefficient of approximately 8 ppm/°C.

The manganese ferrite is a dense, temperature stable material displaying a high degree of squareness in its hysteresis loop. This makes this material uniquely suited for such applications as multiple output control in switched-mode power supplies and high frequency magnetic amplifiers.

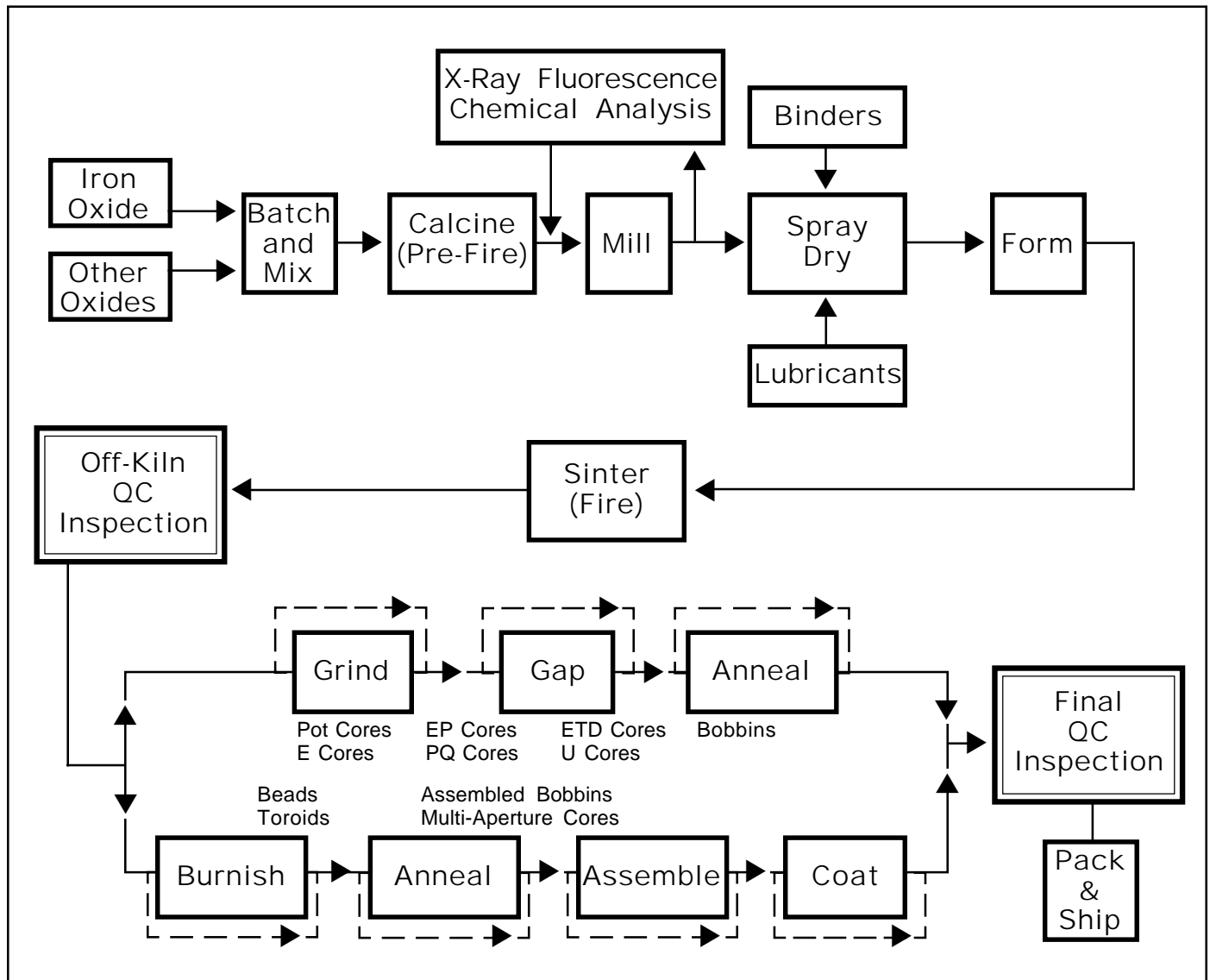
As is evident from the flow diagram on page 3, there is considerable processing involved, and the manufacturing cycle will take a minimum of two weeks. The parts listed in the catalog represent a broad cross section of the wide variety of cores produced by Fair-Rite Products. Large OEM quantities are manufactured by Fair-Rite to order. Most of the more commonly used parts are stocked by our distributors, offering prompt deliveries. For a complete listing of our distributors visit our site on the Internet at [www.fair-rite.com](http://www.fair-rite.com).

Many of the parts produced by Fair-Rite are made to customer specifications, and we welcome inquiries involving application-specific designs. We have the capability to design tooling rapidly, and have it fabricated either by our own tool shop or by outside vendors.

**\*Footnote:** *The difference between hard and soft ferrite is not tactile, but rather a magnetic characteristic. Soft ferrite does not retain significant magnetization, whereas hard ferrite magnetization is considered permanent.*

# Introduction

## Simplified Process Flow Diagram



Fair-Rite Products Corp.  
 CAGE # 34899  
 Federal ID# 141389596

Ferrite Cores  
 Standard Industrial Classification (SIC) 3264  
 North American Industry  
 Classification System (NAICS) 327113

# Magnetic Properties of Ferrite Materials

Property	Unit	Symbol	68	67	61	51*	44
Initial Permeability @ B <10 gauss		$\mu_i$	20	40	125	350	500
Flux Density @ Field Strength	gauss mT oersted A/m	$B$  $H$	2700 270 40 3200	2300 230 20 1600	2350 235 15 1200	3200 320 10 800	3000 300 10 800
Residual Flux Density	gauss mT	$B_r$	1000 100	800 80	1200 120	1200 120	1100 110
Coercive Force	oersted A/m	$H_c$	7.0 560	3.5 280	1.8 144	0.60 48	0.45 36
Loss Factor @ Frequency	$10^{-6}$ MHz	$\tan \delta/\mu_i$	500 100	150 50	30 1.0	40 1.0	125 1.0
Temperature Coefficient of Initial Permeability (20-70 °C)	%/°C		0.10	0.05	0.10	0.8	0.75
Curie Temperature	°C	$T_c$	>500	>475	>350	>170	>160
Resistivity	$\Omega$ cm	$\rho$	$1 \times 10^7$	$1 \times 10^7$	$1 \times 10^8$	$1 \times 10^9$	$1 \times 10^9$
Power Loss Density 25kHz - 2000 G - 100°C 100kHz - 1000 G - 100°C	mW/cm <sup>3</sup>	$P$	— —	— —	— —	— —	— —
Recommended Frequency Range	MHz						
Application Areas	Low flux density devices. EMI suppression. Power magnetics. Special square loop ferrite.		<400 — — —	<300 — — —	<100 >200 — —	— <1000 — —	— 20-250 — —
See this page for additional material data			6	7	8	9	10

42 Material, specifically developed for absorber applications in anechoic chambers, is listed on page 126.

\* New Fair-Rite material, added in this edition of the catalog.

Additional ferrite mechanical and thermal characteristics are tabulated on page 159.

# Magnetic Properties of Ferrite Materials

33	43	85	31*	77	78	73	75	76
600	850	900	1500	2000	2300	2500	5000	10000
2800 280 5 400	2900 290 10 800	4200 420 10 800	3400 340 5 400	4900 490 5 400	4800 480 5 400	3900 390 5 400	4300 430 5 400	4000 400 5 400
1200 120	1300 130	3700 370	2500 250	1800 180	1500 150	1500 150	1400 140	1800 180
0.60 48	0.45 36	0.50 40	0.35 28	0.30 24	0.20 16	0.24 19.2	0.16 13	0.12 9.6
25 0.2	250 1.0	30 0.1	20 0.1	15 0.1	4.5 0.1	10 0.1	15 0.1	15 0.025
0.10	1.25	–	1.6	0.7	1.0	0.65	0.6	0.5
>150	>130	>200	>130	>200	>200	>160	>140	>120
1x10 <sup>2</sup>	1x10 <sup>5</sup>	2x10 <sup>2</sup>	3x10 <sup>3</sup>	1x10 <sup>2</sup>	2x10 <sup>2</sup>	1x10 <sup>2</sup>	3x10 <sup>2</sup>	50
– –	– –	– –	– –	200 –	<115 <130	– –	140 –	– –
<3 – – –	<10 20-250 – –	– – – <0.15	– <500 – –	<3 – <0.1 –	<2.5 – <0.5 –	– <30 – –	<0.75 – <0.1 –	<0.5 – – –
11	12	13	14	16	18	20	21	22

# 68 Material

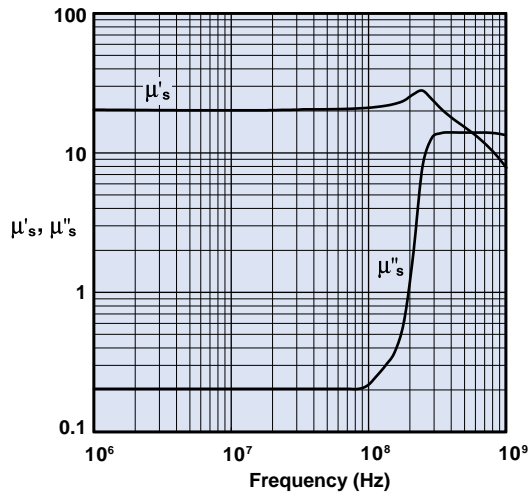
Our highest frequency NiZn ferrite intended for broadband transformers, antennas and HF high Q inductor applications up to 100 MHz. This material is only supplied to customer-specific requirements and close consultation with our application staff is suggested.

*Strong magnetic fields or excessive mechanical stresses may result in irreversible changes in permeability and losses.*

## 68 Material Specifications:

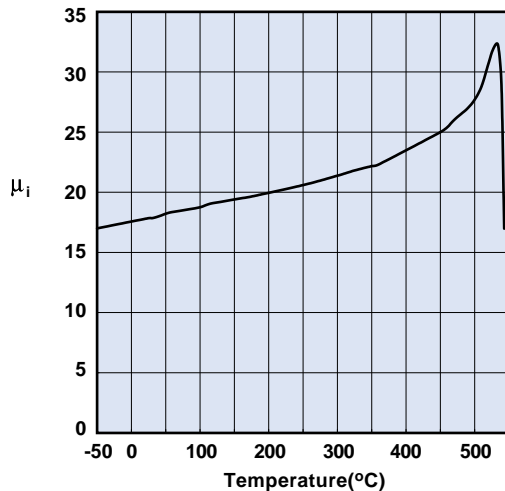
Property	Unit	Symbol	Value
Initial Permeability @ B < 10 gauss		$\mu_i$	20
Flux Density @ Field Strength	gauss oersted	B H	2700 40
Residual Flux Density	gauss	$B_r$	1000
Coercive Force	oersted	$H_c$	7.0
Loss Factor @ Frequency	$10^{-6}$ MHz	$\tan \delta/\mu_i$	500 100
Temperature Coefficient of Initial Permeability (20 -70°C)	%/°C		0.10
Curie Temperature	°C	$T_c$	>500
Resistivity	$\Omega$ cm	$\rho$	$1 \times 10^7$

### Complex Permeability vs. Frequency



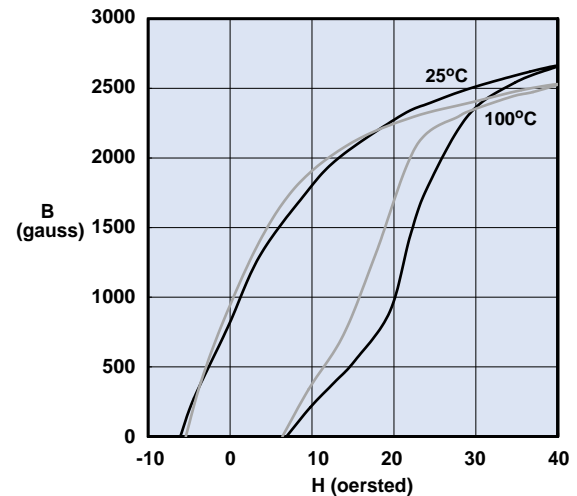
Measured on an 18/10/6mm toroid using the HP 4284A and the HP 4291A.

### Initial Permeability vs. Temperature



Measured on an 18/10/6mm toroid at 100kHz.

### Hysteresis Loop



Measured on an 18/10/6mm toroid at 10kHz.

# 67 Material

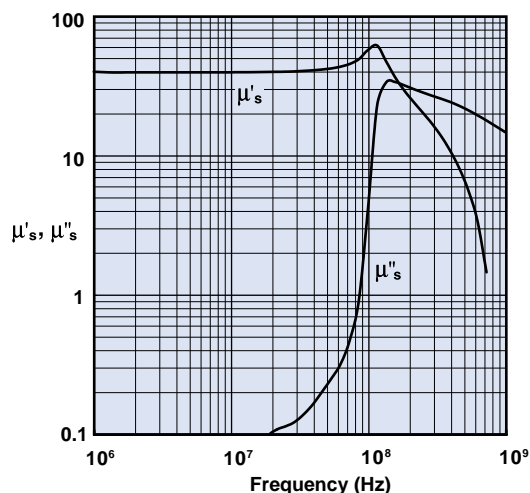
A high frequency NiZn ferrite for the design of broadband transformers, antennas and HF, high Q inductor applications up to 50 MHz. This material is only supplied to customer-specific requirements and close consultation with our application staff is suggested.

*Strong magnetic fields or excessive mechanical stresses may result in irreversible changes in permeability and losses.*

### 67 Material Specifications:

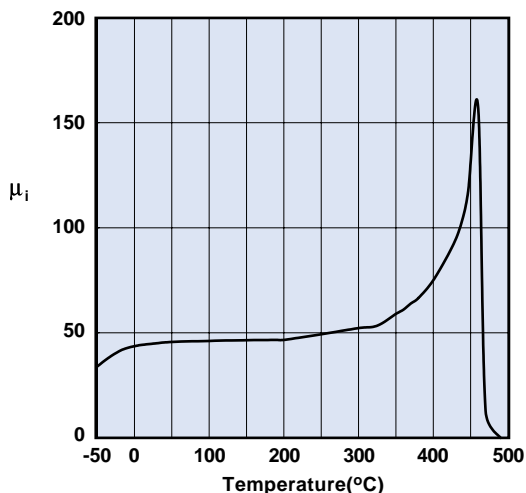
Property	Unit	Symbol	Value
Initial Permeability @ B < 10 gauss		$\mu_i$	40
Flux Density @ Field Strength	gauss oersted	B H	2300 20
Residual Flux Density	gauss	$B_r$	800
Coercive Force	oersted	$H_c$	3.5
Loss Factor @ Frequency	$10^{-6}$ MHz	$\tan \delta \mu_i$	150 50
Temperature Coefficient of Initial Permeability (20 -70°C)	%/°C		0.05
Curie Temperature	°C	$T_c$	>475
Resistivity	$\Omega$ cm	$\rho$	$1 \times 10^7$

### Complex Permeability vs. Frequency



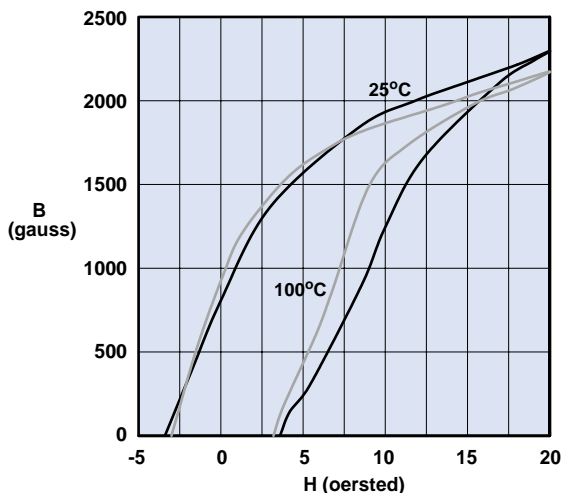
Measured on an 19/10/6mm toroid using the HP 4284A and the HP 4291A.

### Initial Permeability vs. Temperature



Measured on a 19/10/6mm toroid at 100kHz.

### Hysteresis Loop



Measured on a 19/10/6mm toroid at 10kHz.

# 61 Material

A high frequency NiZn ferrite developed for a range of inductive applications up to 25 MHz. This material is also used in EMI applications for suppression of noise frequencies above 200 MHz.

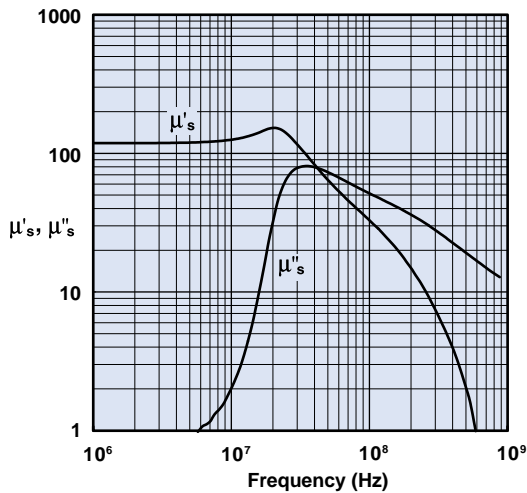
EMI suppression beads, beads on leads, SM beads, wound beads, multi-aperture cores, round cable EMI suppression cores, rods, RFID rods, and toroids are all available in 61 material.

*Strong magnetic fields or excessive mechanical stresses may result in irreversible changes in permeability and losses.*

## 61 Material Specifications:

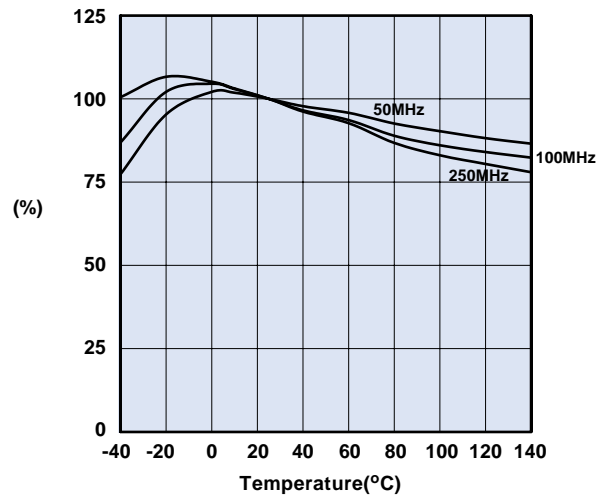
Property	Unit	Symbol	Value
Initial Permeability @ B < 10 gauss		$\mu_i$	125
Flux Density @ Field Strength	gauss oersted	B H	2350 15
Residual Flux Density	gauss	$B_r$	1200
Coercive Force	oersted	$H_c$	1.8
Loss Factor @ Frequency	$10^{-6}$ MHz	$\tan \delta / \mu_i$	30 1.0
Temperature Coefficient of Initial Permeability (20 -70°C)	%/°C		0.10
Curie Temperature	°C	$T_c$	>350
Resistivity	$\Omega$ cm	$\rho$	$1 \times 10^8$

Complex Permeability vs. Frequency



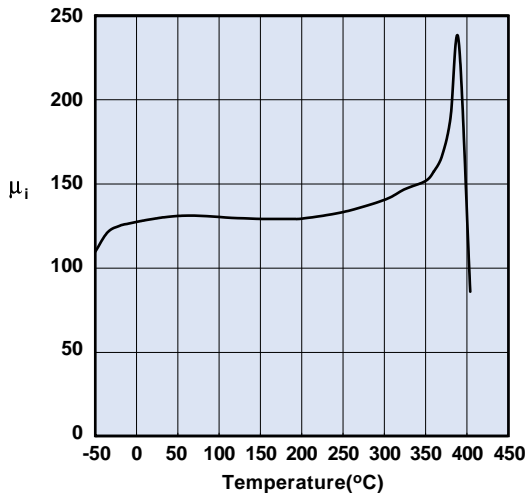
Measured on a 19/10/6mm toroid using the HP 4284A and the HP 4291A.

Percent of Original Impedance vs. Temperature



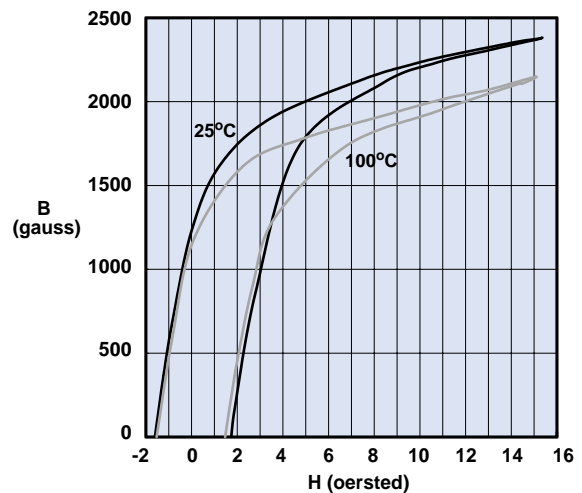
Measured on a 2661000301 using the HP4291A.

Initial Permeability vs. Temperature



Measured on a 19/10/6mm toroid at 100kHz.

Hysteresis Loop



Measured on a 19/10/6mm toroid at 10kHz.



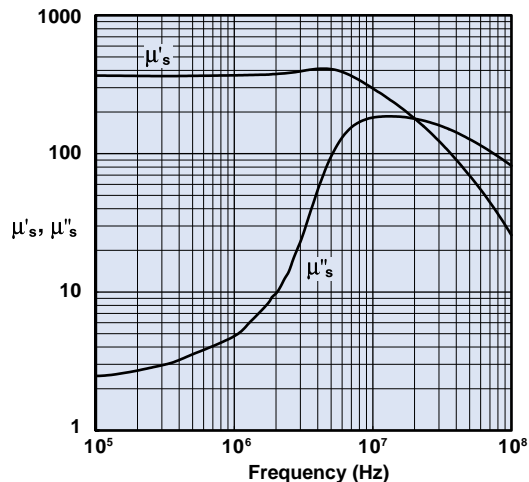
# 51 Material

A new NiZn ferrite developed for low loss inductive designs for frequencies up to 5.0 MHz.

## 51 Material Specifications:

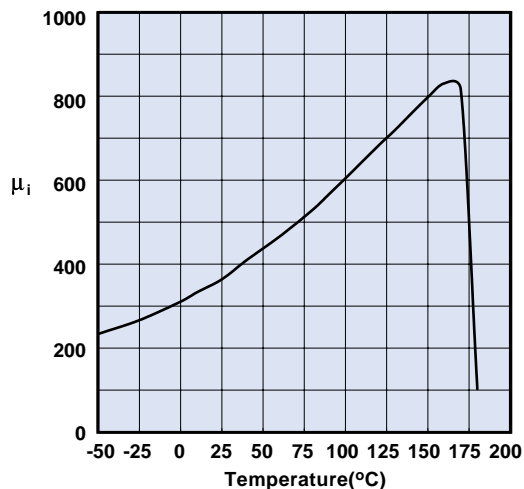
Property	Unit	Symbol	Value
Initial Permeability @ B < 10 gauss		$\mu_i$	350
Flux Density @ Field Strength	gauss oersted	B H	3200 10
Residual Flux Density	gauss	$B_r$	1200
Coercive Force	oersted	$H_c$	0.60
Loss Factor @ Frequency	$10^{-6}$ MHz	$\tan\delta/\mu_i$	40 1.0
Temperature Coefficient of Initial Permeability (20 -70°C)	%/°C		0.8
Curie Temperature	°C	$T_c$	>170
Resistivity	$\Omega$ cm	$\rho$	$1 \times 10^9$

### Complex Permeability vs. Frequency



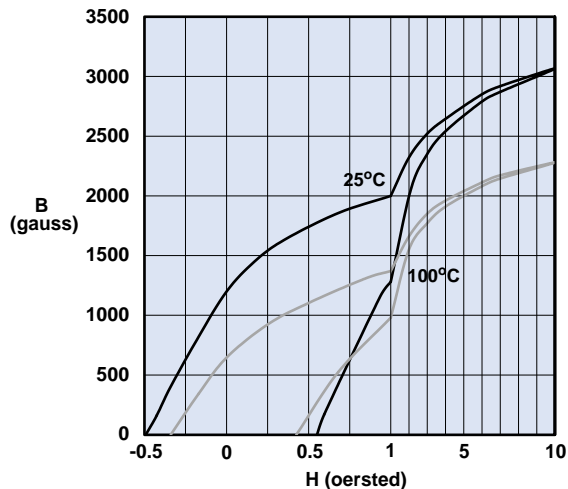
Measured on a 17/10/6mm toroid using the HP 4284A and the HP 4291A.

### Initial Permeability vs. Temperature



Measured on a 17/10/6mm toroid at 100kHz.

### Hysteresis Loop



Measured on a 17/10/6mm toroid at 10kHz.

# 44 Material

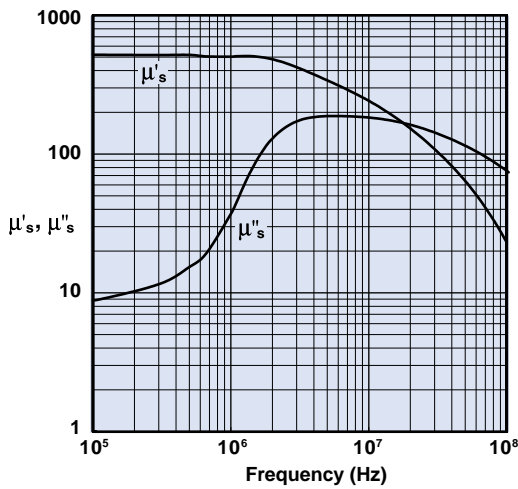
A NiZn ferrite developed to combine a high suppression performance, from 30 MHz to 500 MHz, with a very high dc resistivity.

SM beads, PC beads, wound beads, split round cable EMI suppression cores, round cable snap-its, and connector EMI suppression plates are all available in 44 material.

### 44 Material Specifications:

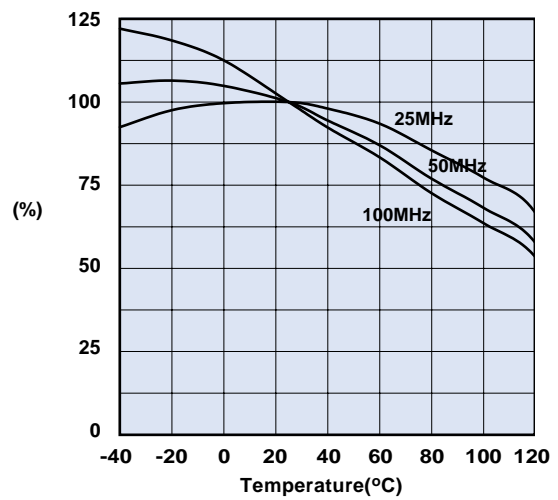
Property	Unit	Symbol	Value
Initial Permeability @ B < 10 gauss		$\mu_i$	500
Flux Density @ Field Strength	gauss oersted	B H	3000 10
Residual Flux Density	gauss	$B_r$	1100
Coercive Force	oersted	$H_c$	0.45
Loss Factor @ Frequency	$10^{-6}$ MHz	$\tan \delta / \mu_i$	125 1.0
Temperature Coefficient of Initial Permeability (20 -70°C)	%/°C		0.75
Curie Temperature	°C	$T_c$	>160
Resistivity	$\Omega$ cm	$\rho$	$1 \times 10^9$

**Complex Permeability vs. Frequency**



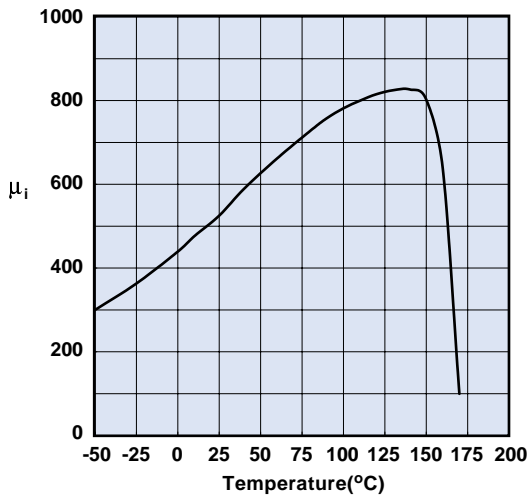
Measured on a 17/10/6mm toroid using the HP 4284A and the HP 4291A.

**Percent of Original Impedance vs. Temperature**



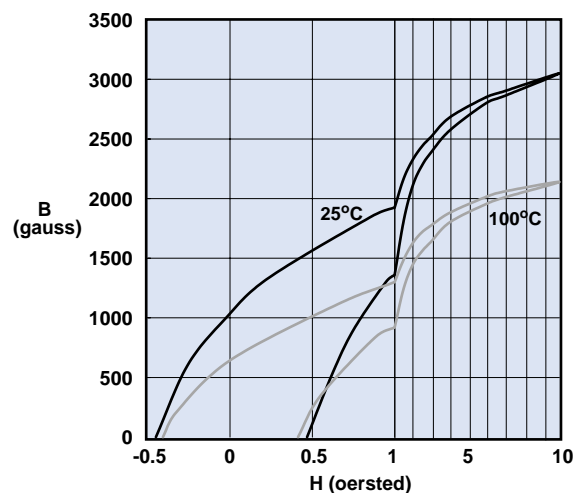
Measured on a 2644000301 using the HP4291A.

**Initial Permeability vs. Temperature**



Measured on a 17/10/6mm toroid at 100kHz.

**Hysteresis Loop**



Measured on a 17/10/6mm toroid at 10kHz.

# 33 Material

An economical MnZn ferrite designed for use in open circuit applications for frequencies up to 3.0 MHz.

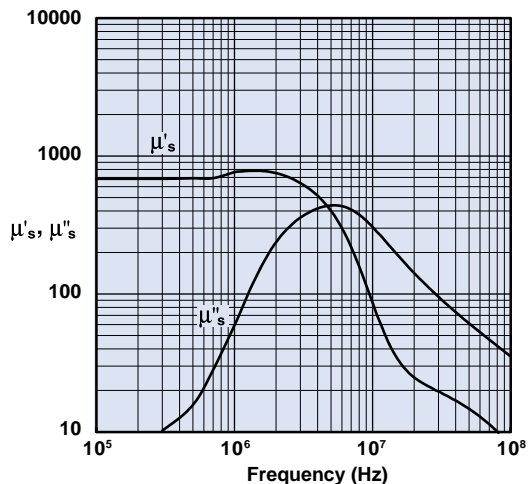
Rods are available in 33 material.

*Note: This material is not recommended for new designs.*

### 33 Material Specifications:

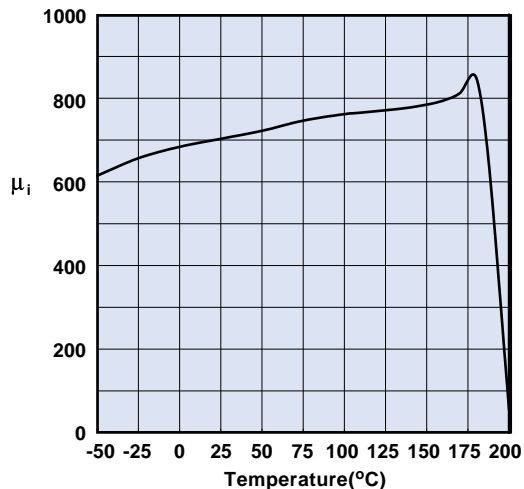
Property	Unit	Symbol	Value
Initial Permeability @ B < 10 gauss		$\mu_i$	600
Flux Density @ Field Strength	gauss oersted	B H	2800 5
Residual Flux Density	gauss	$B_r$	1200
Coercive Force	oersted	$H_c$	0.60
Loss Factor @ Frequency	$10^{-6}$ MHz	$\tan \delta / \mu_i$	25 0.2
Temperature Coefficient of Initial Permeability (20 -70°C)	%/°C		0.10
Curie Temperature	°C	$T_c$	>150
Resistivity	$\Omega$ cm	$\rho$	$1 \times 10^2$

**Complex Permeability vs. Frequency**



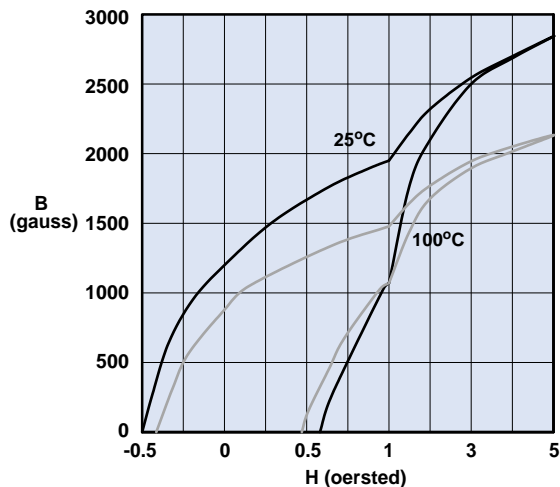
Measured on a 17/10/6mm toroid using the HP 4284A and, the HP 4291A.

**Initial Permeability vs. Temperature**



Measured on a 17/10/6mm toroid at 100kHz.

**Hysteresis Loop**



Measured on a 17/10/6mm toroid at 10kHz.

# 43 Material

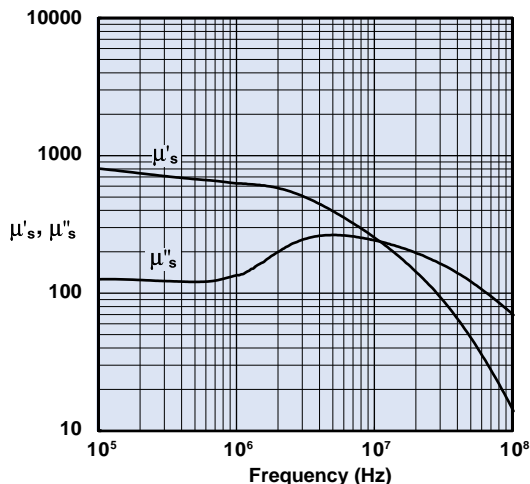
This NiZn is our most popular ferrite for suppression of conducted EMI from 20 MHz to 250 MHz. This material is also used for inductive applications such as high frequency common-mode chokes.

EMI suppression beads, beads on leads, SM beads, multi-aperture cores, round cable EMI suppression cores, split round EMI suppression cores, round cable snap-its, flat cable EMI suppression cores, flat cable snap-its, miscellaneous suppression cores, bobbins, and toroids are all available in 43 material.

## 43 Material Specifications:

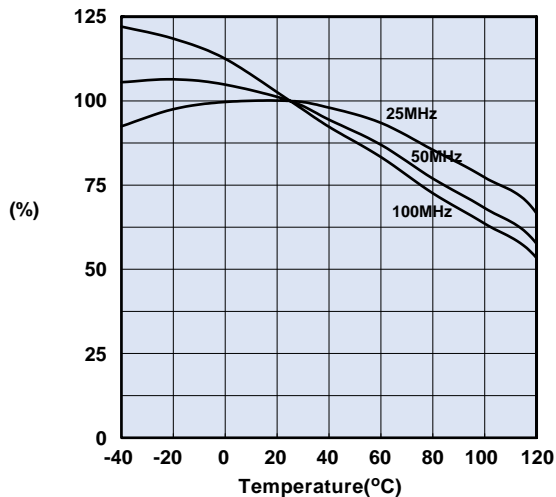
Property	Unit	Symbol	Value
Initial Permeability @ B < 10 gauss		$\mu_i$	850
Flux Density @ Field Strength	gauss oersted	B H	2900 10
Residual Flux Density	gauss	$B_r$	1300
Coercive Force	oersted	$H_c$	0.45
Loss Factor @ Frequency	$10^{-6}$ MHz	$\tan \delta / \mu_i$	250 1.0
Temperature Coefficient of Initial Permeability (20 -70°C)	%/°C		1.25
Curie Temperature	°C	$T_c$	>130
Resistivity	$\Omega$ cm	$\rho$	$1 \times 10^5$

**Complex Permeability vs. Frequency**



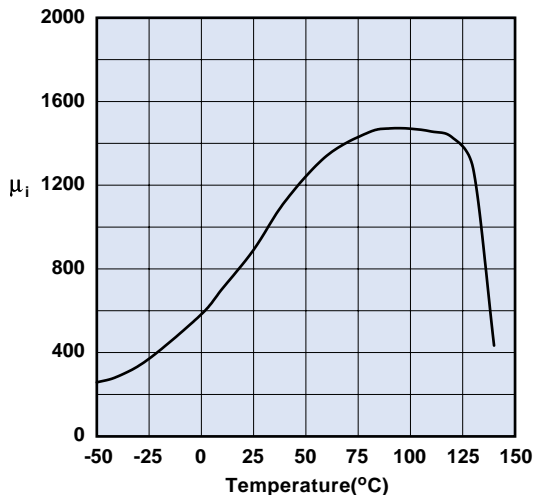
Measured on a 17/10/6mm toroid using the HP 4284A and the HP 4291A.

**Percent of Original Impedance vs. Temperature**



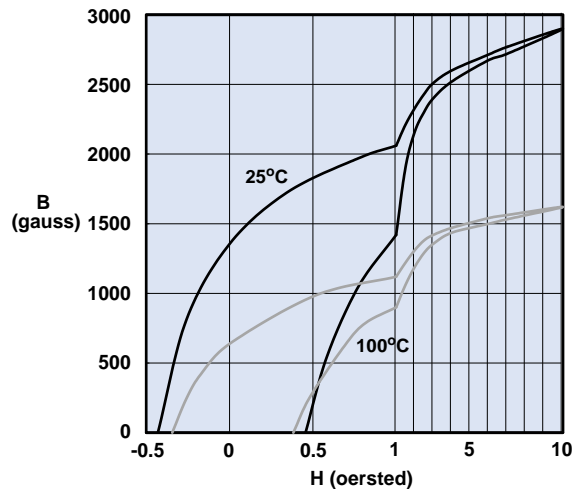
Measured on a 2643000301 using the HP4291A.

**Initial Permeability vs. Temperature**



Measured on a 17/10/6mm toroid at 100kHz.

**Hysteresis Loop**



Measured on a 17/10/6mm toroid at 10kHz.

# 85 Material

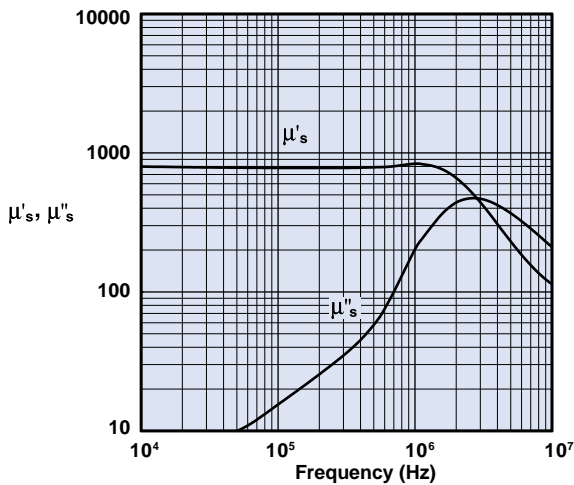
A square hysteresis loop Mn ferrite developed for use in output regulators and magnetic amplifier designs.

Toroids are available in 85 material.

### 85 Material Specifications:

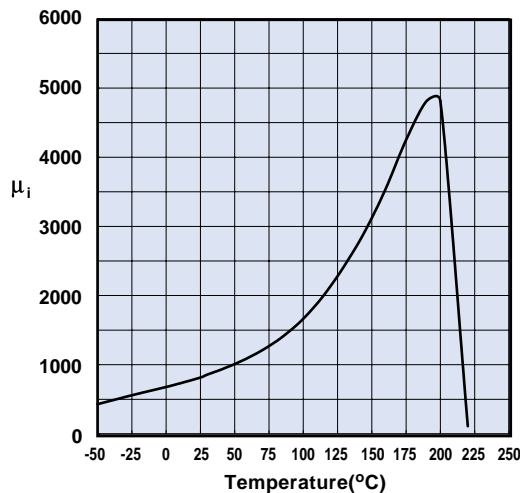
Property	Unit	Symbol	Value
Initial Permeability @ B < 10 gauss		$\mu_i$	900
Flux Density @ Field Strength	gauss oersted	B H	4200 10
Residual Flux Density	gauss	$B_r$	3700
Coercive Force	oersted	$H_c$	0.50
Loss Factor @ Frequency	$10^{-6}$ MHz	$\tan \delta / \mu_i$	30 0.1
Temperature Coefficient of Initial Permeability (20 -70°C)	%/°C		—
Curie Temperature	°C	$T_c$	>200
Resistivity	$\Omega$ cm	$\rho$	$2 \times 10^2$

### Complex Permeability vs. Frequency



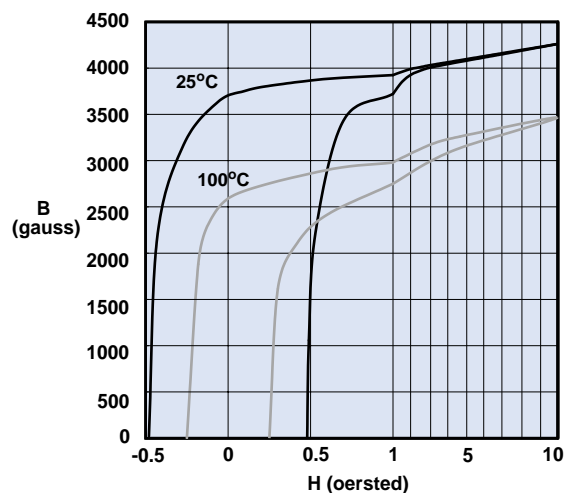
Measured on a 13/8/6mm toroid at 25°C using the HP 4284A and the HP 4291A.

### Initial Permeability vs. Temperature



Measured on a 13/8/6mm toroid at 100kHz using the HP 4275.

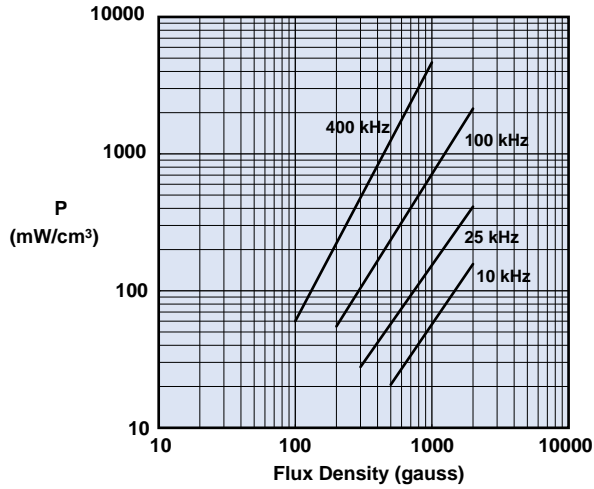
### Hysteresis Loop



Measured on a 13/8/6mm toroid at 10 kHz.

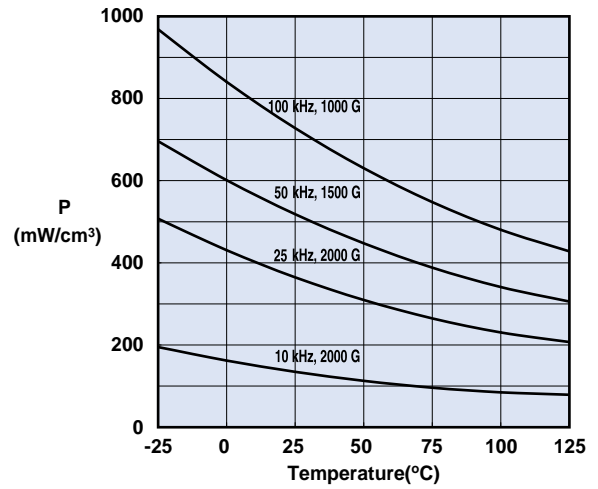
# 85 Material

**Power Loss Density vs. Flux Density**



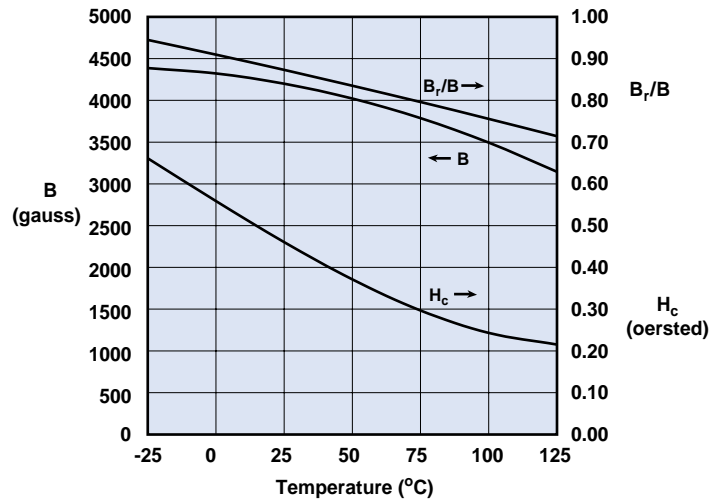
Measured on a 13/8/6mm toroid at 25°C using a Clark Hess 258 VAW.

**Power Loss Density vs. Temperature**



Measured on a 13/8/6mm toroid using a Clark Hess 258 VAW.

**Flux Density, Coercive Force and Squareness Ratio vs. Temperature**



Measured on a 13/8/6mm toroid at 10 kHz. B is measured at H=10 oersted.

# 31 Material

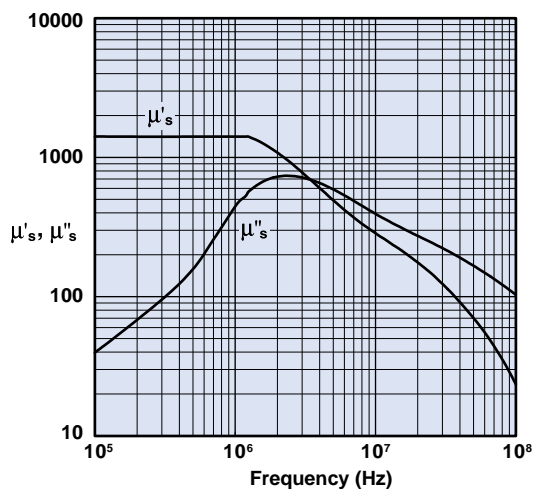
A new MnZn ferrite designed specifically for EMI suppression applications from as low as 1 MHz up to 500 MHz. This material does not have the dimensional resonance limitations associated with conventional MnZn ferrite materials.

EMI suppression beads, round cable EMI suppression cores, round cable snap-its, flat cable EMI suppression cores, and flat cable snap-its are all available in 31 material.

### 31 Material Specifications:

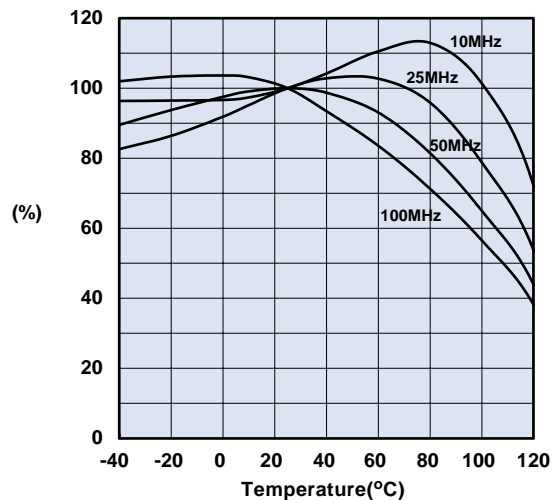
Property	Unit	Symbol	Value
Initial Permeability @ B < 10 gauss		$\mu_i$	1500
Flux Density @ Field Strength	gauss oersted	B H	3400 5
Residual Flux Density	gauss	$B_r$	2500
Coercive Force	oersted	$H_c$	0.35
Loss Factor @ Frequency	$10^{-6}$ MHz	$\tan \delta / \mu_i$	20 0.1
Temperature Coefficient of Initial Permeability (20 -70°C)	%/°C		1.6
Curie Temperature	°C	$T_c$	>130
Resistivity	$\Omega$ cm	$\rho$	$3 \times 10^3$

### Complex Permeability vs. Frequency



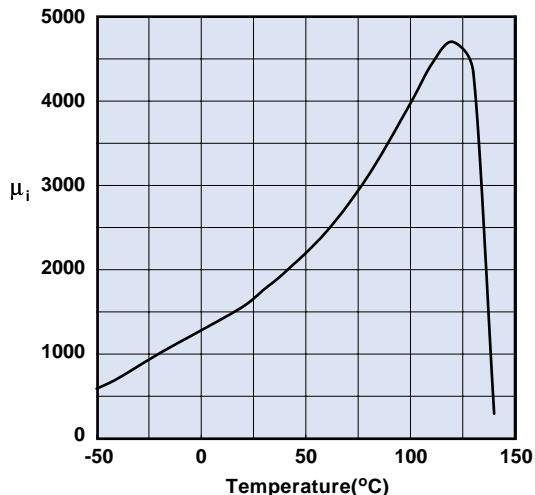
Measured on a 17/10/6mm toroid at 25°C using the HP 4284A and the HP 4291A.

### Percent of Original Impedance vs. Temperature



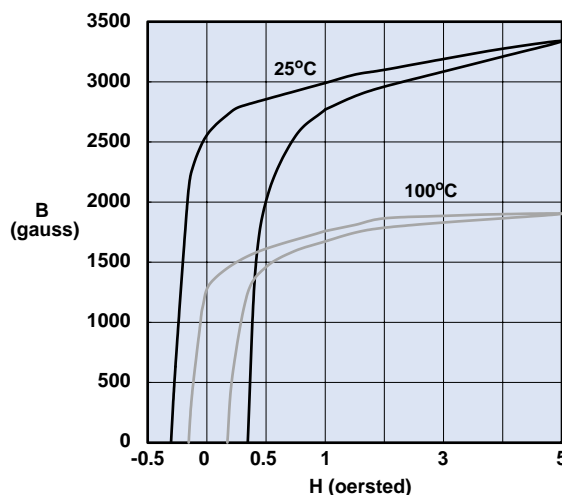
Measured on a 2631000301 using the HP4291A.

### Initial Permeability vs. Temperature



Measured on a 17/10/6mm toroid at 100kHz.

### Hysteresis Loop



Measured on a 17/10/6mm toroid at 10kHz.

# 77 Material

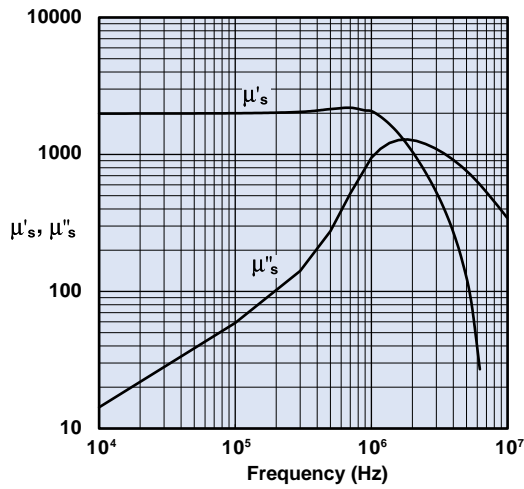
## 77 Material Specifications:

Property	Unit	Symbol	Value
Initial Permeability @ B < 10 gauss		$\mu_i$	2000
Flux Density @ Field Strength	gauss oersted	B H	4900 5
Residual Flux Density	gauss	$B_r$	1800
Coercive Force	oersted	$H_c$	0.30
Loss Factor @ Frequency	$10^{-6}$ MHz	$\tan \delta/\mu_i$	15 0.1
Temperature Coefficient of Initial Permeability (20 -70°C)	%/°C		0.7
Curie Temperature	°C	$T_c$	>200
Resistivity	$\Omega$ cm	$\rho$	$1 \times 10^2$

A MnZn ferrite for use in a wide range of high and low flux density inductive designs for frequencies up to 100 kHz.

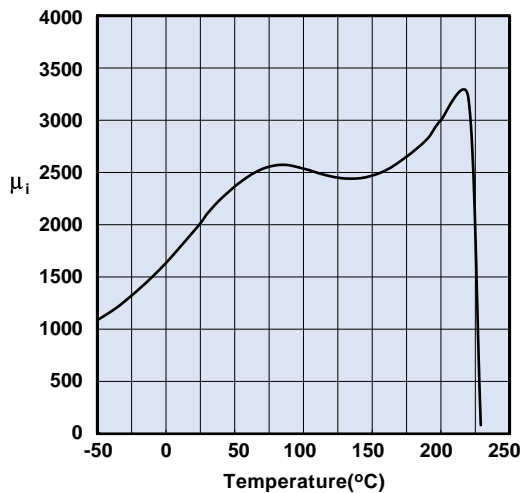
Pot cores, EP cores, PQ cores, ETD cores, E&I cores, U cores, rods, tack bobbin cores, toroids, and bobbins are all available in 77 material.

**Complex Permeability vs. Frequency**



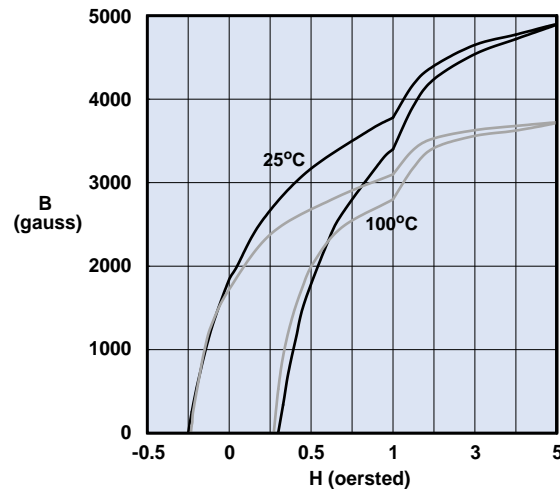
Measured on an 18/10/6mm toroid using the HP 4284A and the HP 4291A.

**Initial Permeability vs. Temperature**



Measured on an 18/10/6mm toroid at 100kHz.

**Hysteresis Loop**

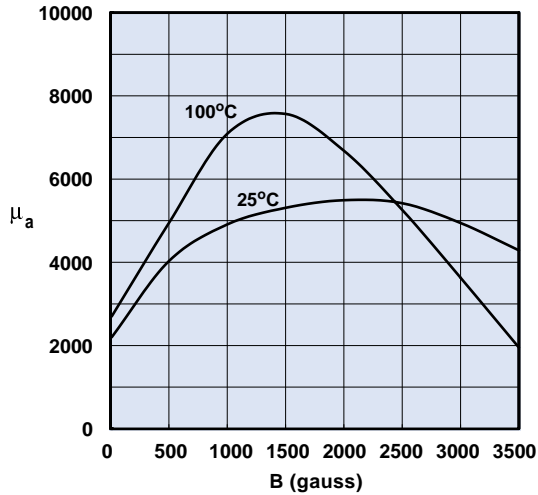


Measured on an 18/10/6mm toroid at 10kHz.



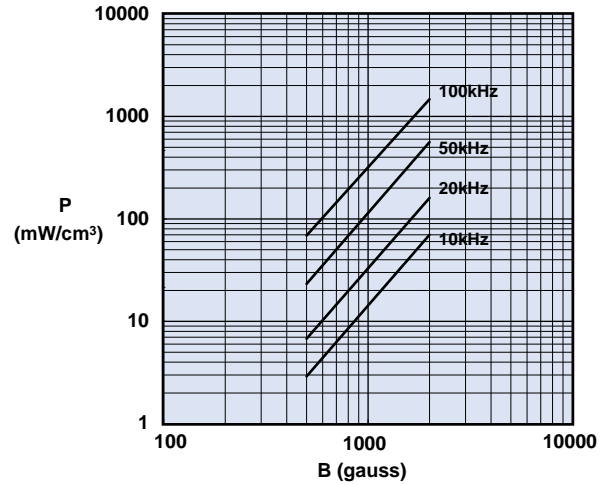
# 77 Material

**Amplitude Permeability vs. Flux Density**



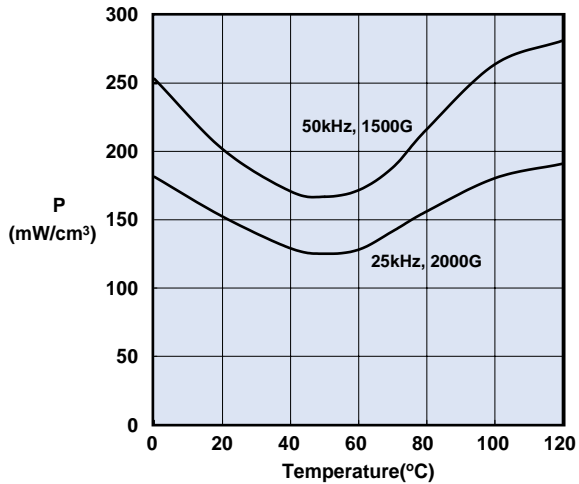
Measured on an 18/10/6mm toroid at 10kHz.

**Power Loss Density vs. Flux Density**



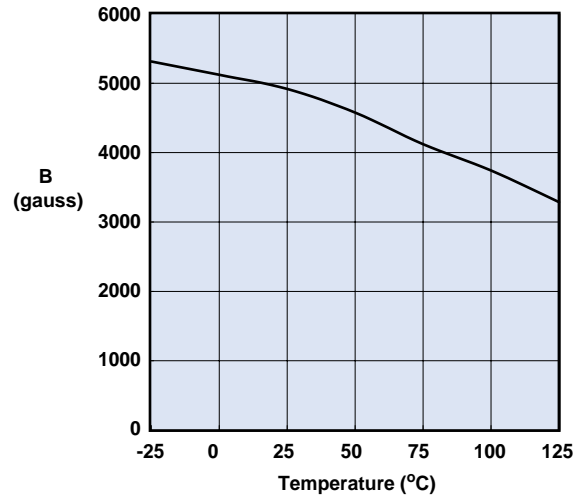
Measured on an 18/10/6mm toroid using the Clarke Hess 258 VAW at 100°C

**Power Loss Density vs. Temperature**



Measured on an 18/10/6mm toroid using the Clarke Hess 258 VAW.

**Flux Density vs. Temperature**



Measured on an 18/10/6mm toroid at 10kHz and H=5 oersted.

# 78 Material

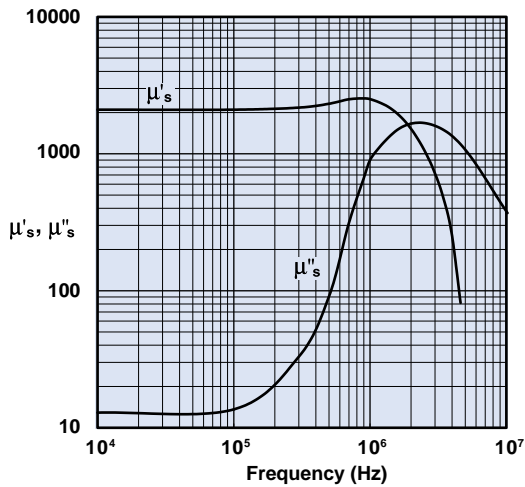
A MnZn ferrite specifically designed for power applications for frequencies up to 200 kHz.

RFID rods, toroids, pot cores, EP cores, PQ cores, ETD cores, U cores, and E&I cores are all available in 78 material.

## 78 Material Specifications:

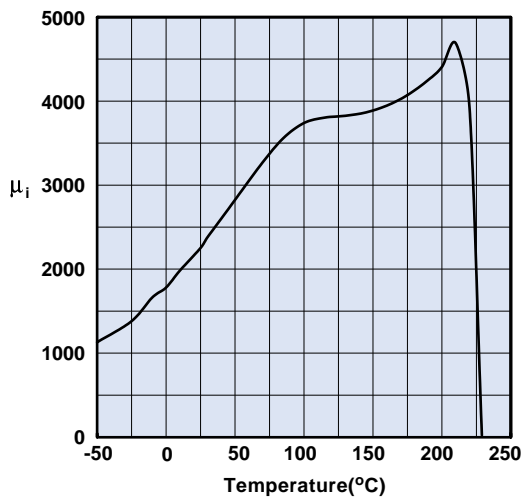
Property	Unit	Symbol	Value
Initial Permeability @ B < 10 gauss		$\mu_i$	2300
Flux Density @ Field Strength	gauss oersted	B H	4800 5
Residual Flux Density	gauss	$B_r$	1500
Coercive Force	oersted	$H_c$	0.20
Loss Factor @ Frequency	$10^{-6}$ MHz	$\tan \delta / \mu_i$	4.5 0.1
Temperature Coefficient of Initial Permeability (20 -70°C)	%/°C		1.0
Curie Temperature	°C	$T_c$	>200
Resistivity	$\Omega$ cm	$\rho$	$2 \times 10^2$

### Complex Permeability vs. Frequency



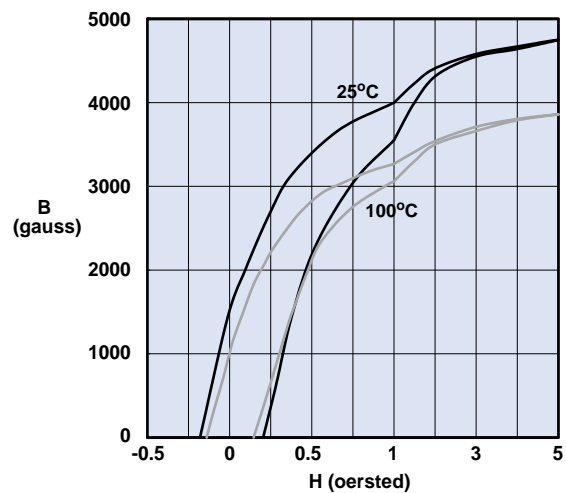
Measured on an 18/10/6mm toroid using the HP 4284A and the HP 4291A.

### Initial Permeability vs. Temperature



Measured on an 18/10/6mm toroid at 100kHz.

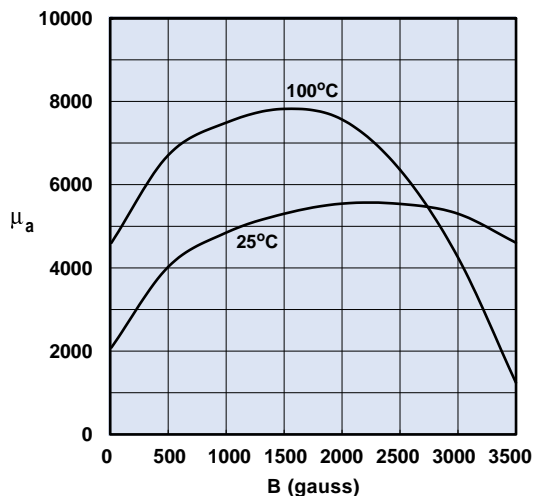
### Hysteresis Loop



Measured on an 18/10/6mm toroid at 10kHz.

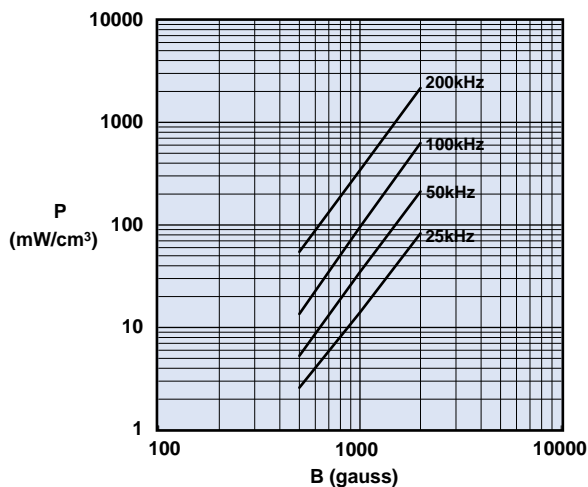
# 78 Material

**Amplitude Permeability vs. Flux Density**



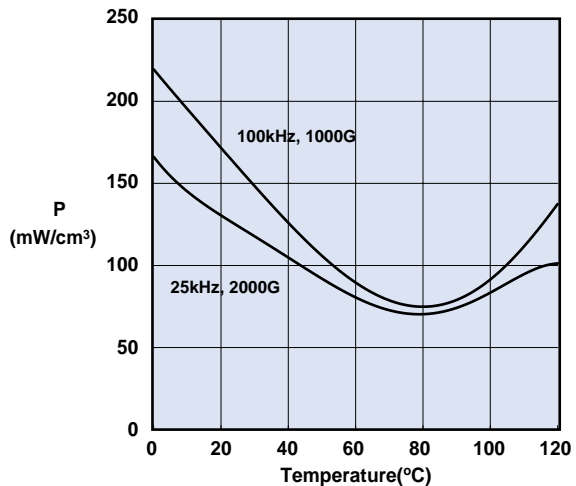
Measured on an 18/10/6mm toroid at 10kHz.

**Power Loss Density vs. Flux Density**



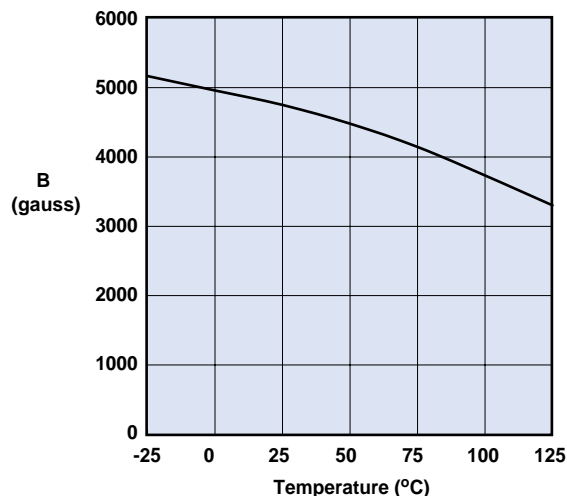
Measured on an 18/10/6mm toroid using the Clarke Hess 258 VAW at 100°C

**Power Loss Density vs. Temperature**



Measured on an 18/10/6mm toroid using the Clarke Hess 258 VAW.

**Flux Density vs. Temperature**



Measured on an 18/10/6 mm toroid at 10kHz and H=5 oersted.

# 73 Material

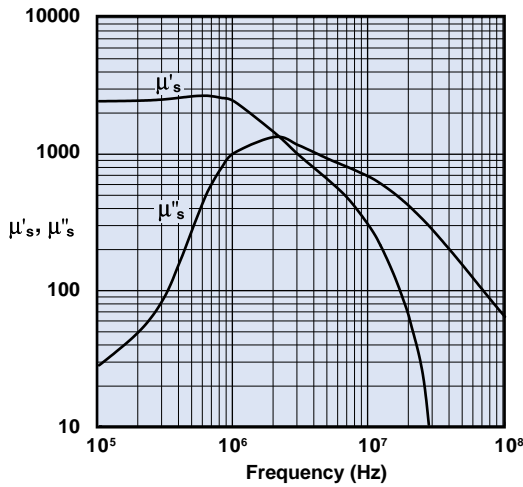
A MnZn ferrite, supplied only in small cores, to suppress conducted EMI frequencies below 30 MHz.

EMI suppression beads, beads on leads, SM beads, and multi-aperture cores are all available in 73 material.

### 73 Material Specifications:

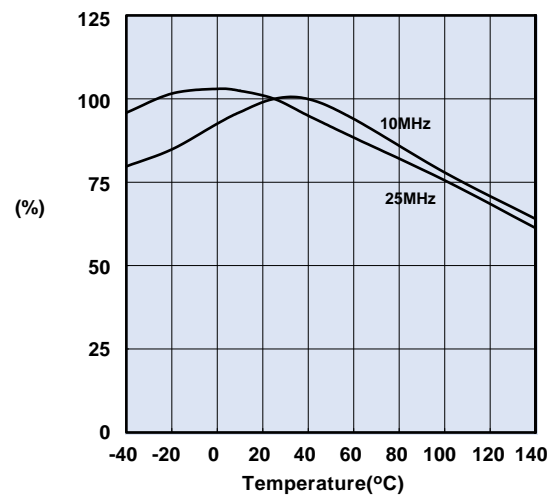
Property	Unit	Symbol	Value
Initial Permeability @ B < 10 gauss		$\mu_i$	2500
Flux Density @ Field Strength	gauss oersted	B H	3900 5
Residual Flux Density	gauss	$B_r$	1500
Coercive Force	oersted	$H_c$	0.24
Loss Factor @ Frequency	$10^{-6}$ MHz	$\tan \delta / \mu_i$	10 0.1
Temperature Coefficient of Initial Permeability (20 -70°C)	%/°C		0.65
Curie Temperature	°C	$T_c$	>160
Resistivity	$\Omega$ cm	$\rho$	$1 \times 10^2$

Complex Permeability vs. Frequency



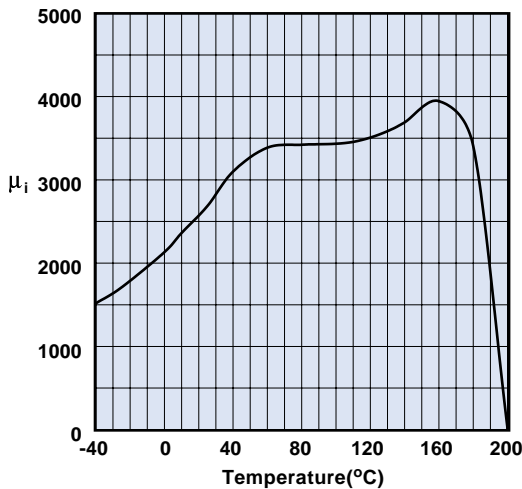
Measured on a 2673000301 bead using the HP 4284A and the HP 4291A.

Percent of Original Impedance vs. Temperature



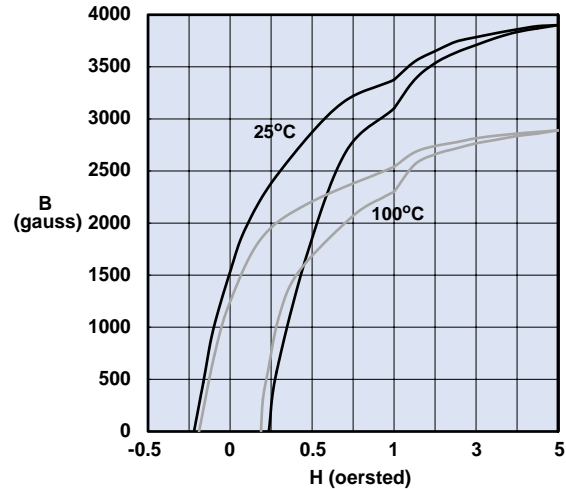
Measured on a 2673000301 using the HP4291A.

Initial Permeability vs. Temperature



Measured on a 17/10/6mm toroid at 10kHz.

Hysteresis Loop



Measured on a 17/10/6mm toroid at 10kHz.

# 75 Material

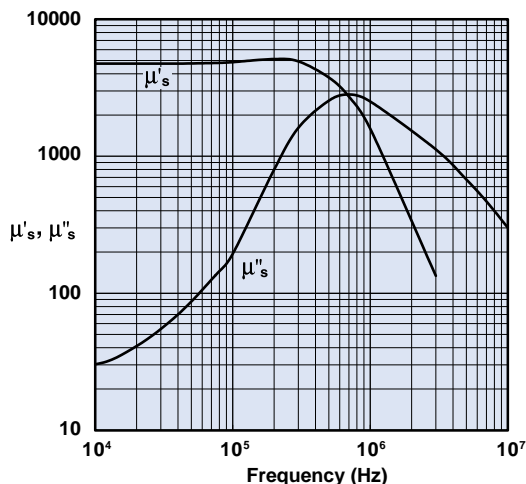
A high permeability MnZn ferrite intended for a range of broadband and pulse transformer applications and common-mode inductor designs.

Toroids, E&I cores, and EP cores are all available in 75 material.

### 75 Material Specifications:

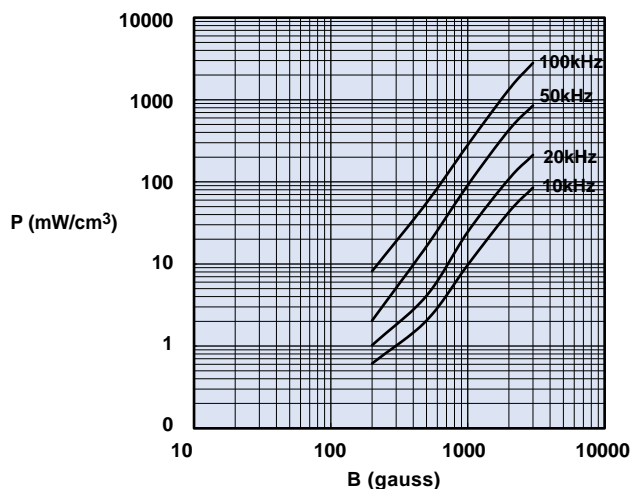
Property	Unit	Symbol	Value
Initial Permeability @ B < 10 gauss		$\mu_i$	5000
Flux Density @ Field Strength	gauss oersted	B H	4300 5
Residual Flux Density	gauss	$B_r$	1400
Coercive Force	oersted	$H_c$	0.16
Loss Factor @ Frequency	$10^{-6}$ MHz	$\tan\delta\mu_i$	15 0.1
Temperature Coefficient of Initial Permeability (20 -70°C)	%/°C		0.6
Curie Temperature	°C	$T_c$	>140
Resistivity	$\Omega$ cm	$\rho$	$3 \times 10^2$

**Complex Permeability vs. Frequency**



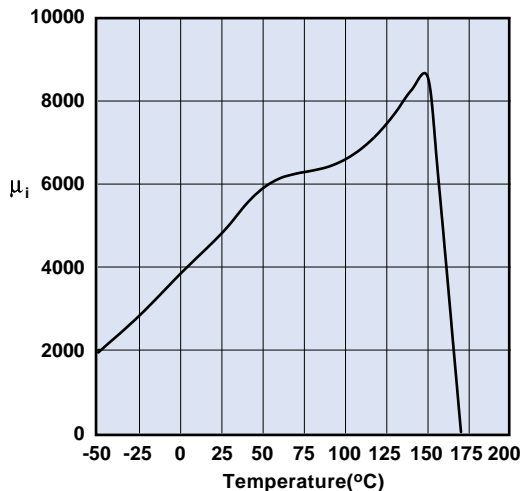
Measured on a 17/10/6mm toroid using the HP 4284A and the HP 4291A.

**Power Loss Density vs. Flux Density**



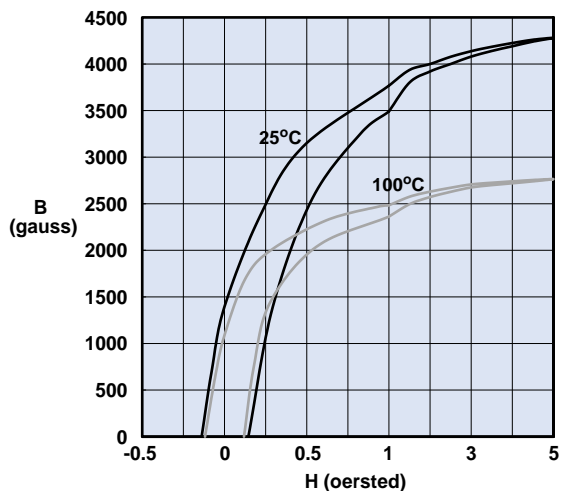
Measured on a 17/10/6mm toroid using the Clarke Hess 258 VAW at 100°C.

**Initial Permeability vs. Temperature**



Measured on a 17/10/6mm toroid at 10kHz.

**Hysteresis Loop**



Measured on a 17/10/6mm toroid at 10kHz.

# 76 Material

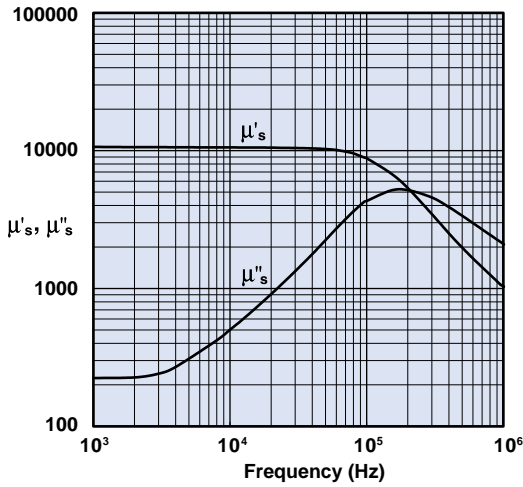
A MnZn ferrite with a 10K permeability and an acceptable Curie temperature for broadband and pulse transformer designs and common-mode choke applications.

Toroids are available in 76 material.

## 76 Material Specifications:

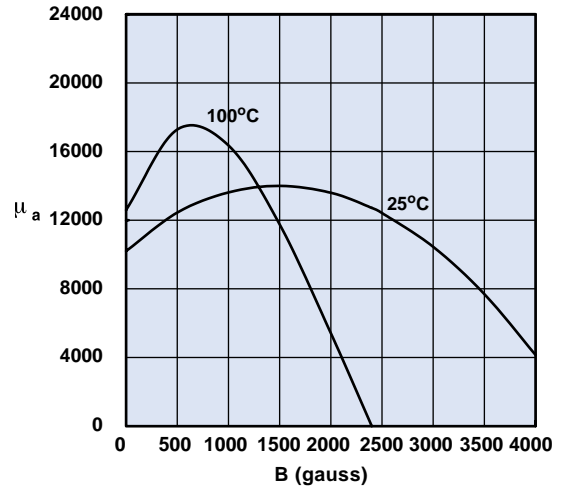
Property	Unit	Symbol	Value
Initial Permeability @ B < 10 gauss		$\mu_i$	10000
Flux Density @ Field Strength	gauss oersted	B H	4000 5
Residual Flux Density	gauss	$B_r$	1800
Coercive Force	oersted	$H_c$	0.12
Loss Factor @ Frequency	$10^{-6}$ MHz	$\tan \delta/\mu_i$	15 0.025
Temperature Coefficient of Initial Permeability (20 -70°C)	%/°C		0.5
Curie Temperature	°C	$T_c$	>120
Resistivity	$\Omega$ cm	$\rho$	50

Complex Permeability vs. Frequency



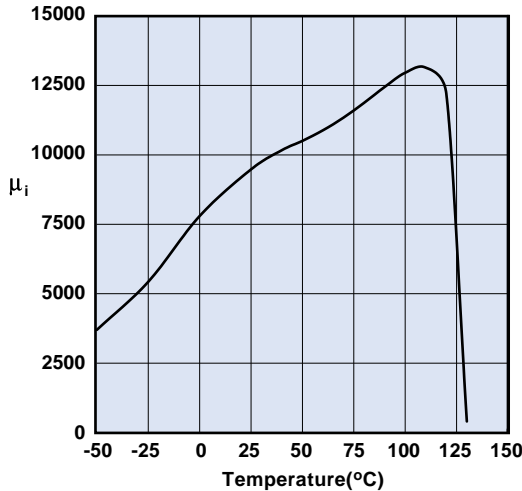
Measured on a 17/10/6mm toroid using the HP 4284A and, the HP 4291A.

Amplitude Permeability vs. Flux Density



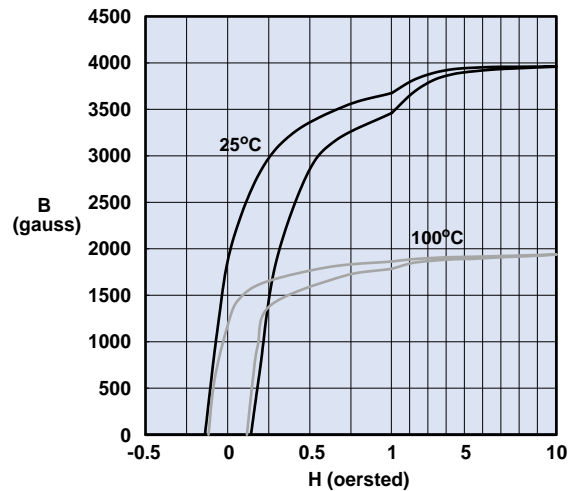
Measured on a 17/10/6mm toroid using the HP 54510A.

Initial Permeability vs. Temperature

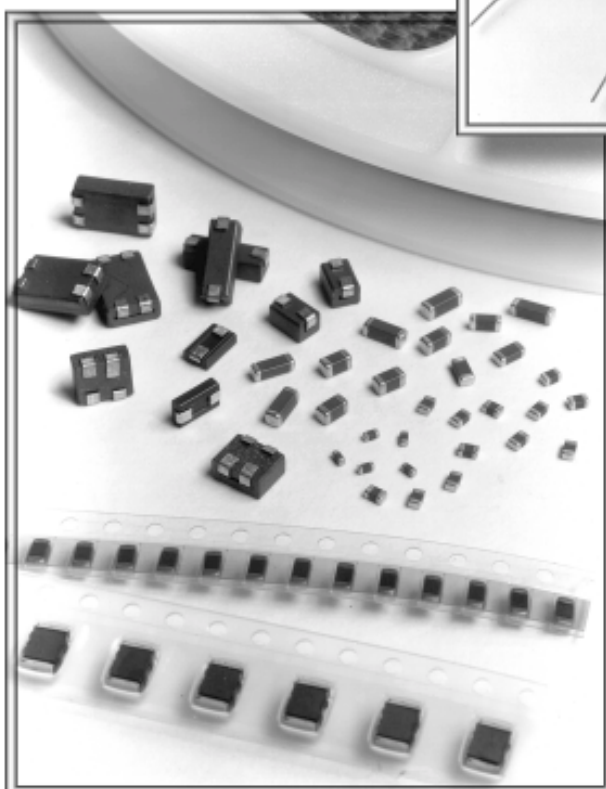
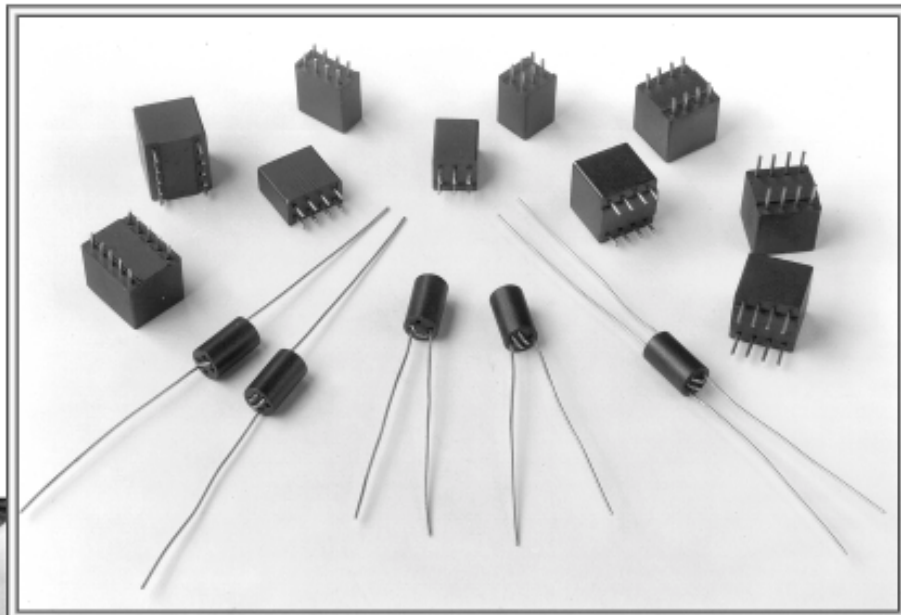


Measured on a 17/10/6mm toroid at 10kHz.

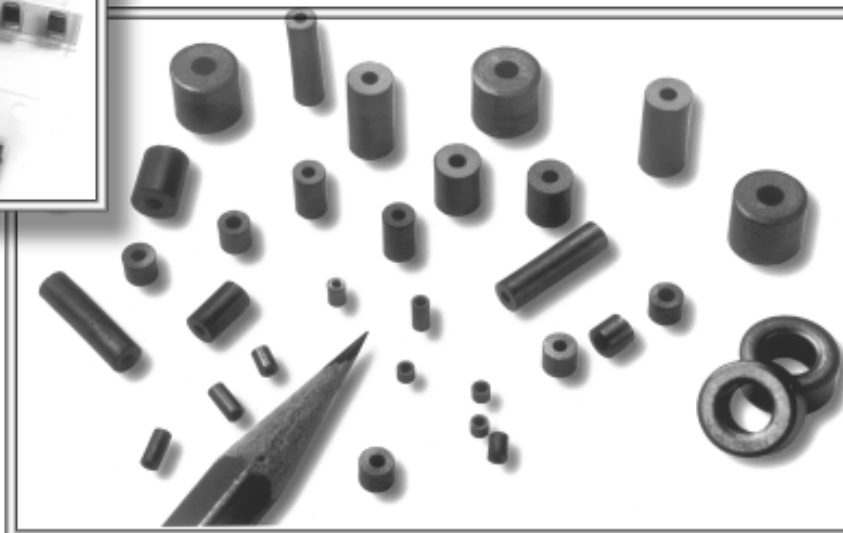
Hysteresis Loop



Measured on a 17/10/6mm toroid at 10kHz.



# Board Components



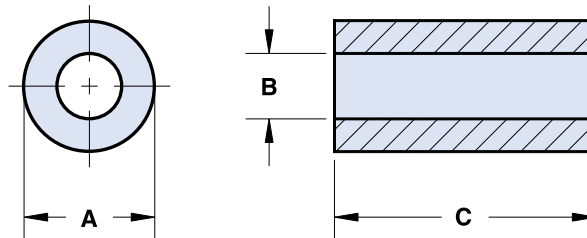
# EMI Suppression Beads

Listed in ascending order of "B" dimension.

Fair-Rite offers a broad selection of EMI suppression beads with guaranteed impedance specifications over a wide frequency range.

- Beads with a "1" as the last digit of the part number are not burnished, those with the last digit "2" are supplied burnished to break the sharp edges.

- Beads can be supplied Parylene coated upon request. The last digit of the Parylene coated part number is a "4". The minimum coating thickness for beads is **0.005mm** (.0002"). See page 159 for material characteristics of Parylene C.



- The "H" column gives for each bead size the calculated dc bias field in oersted for 1 turn and 1 ampere direct current. The actual dc H field in the application is this value of "H" times the actual NI (ampere - turn) product. For the effect of the dc bias on the impedance of the bead material, see the graphs on pages 179-180, Figures 16-20.

- For typical impedance vs. frequency curves for these parts, see Figures 1-6.

- Beads are controlled for impedance limits only. They are tested for impedance with a single turn, using the Hewlett Packard HP 4193A Vector Impedance Meter for beads in 73, 31, and 43 material and the HP 4191A RF Impedance Analyzer for 61 material beads.

- For larger size cores, please refer to our Round Cable EMI Suppression Cores section found on pages 94-97.

- For any EMI suppression bead requirement not listed in the catalog, please contact our customer service group for availability and pricing.

- The EMI Suppression Bead Kit (part number 0199000019) contains a selection of these cores. See page 92.

Dimensions (Bold numbers are in millimeters, light numbers are nominal in inches.)

Typical Impedance( $\Omega$ )<sup>1</sup>

Part Number**	A	B	C*	Wt (g)	H (Oe)	10 MHz	25 MHz	100 MHz	250 MHz
2673901301	<b>0.95 - 0.05</b> .036	<b>0.45+0.1</b> .020	<b>3.8±0.2</b> .150	.01	6.0	16	24	-	-
2673903301	<b>1.0 - 0.05</b> .038	<b>0.45+0.15</b> .021	<b>5.6±0.25</b> .220	.01	5.7	24	35	-	-
<b>2673004601</b>	<b>1.1 - 0.1</b> .041	<b>0.65+0.1</b> .028	<b>4.1 - 0.3</b> .156	.01	4.7	12.5	19	-	-
2643004601	<b>1.1 - 0.1</b> .041	<b>0.65+0.1</b> .028	<b>4.1 - 0.3</b> .156	.01	4.7	-	12.5	31	-
2673004701	<b>1.45 - 0.15</b> .054	<b>0.7+0.1</b> .029	<b>2.3±0.15</b> .090	.01	4.0	12.5	17	-	-
2643004701	<b>1.45 - 0.15</b> .054	<b>0.7+0.1</b> .029	<b>2.3±0.15</b> .090	.01	4.0	-	12.5	26	-
<b>2643004101</b>	<b>3.5±0.2</b> .138	<b>0.75+0.1</b> .031	<b>4.45±0.35</b> .175	.11	2.6	-	48	70	-
<b>2643004201</b>	<b>3.5±0.2</b> .138	<b>0.75+0.1</b> .031	<b>8.9±0.5</b> .350	.22	2.6	-	97	140	-

\*\*Bold part numbers designate preferred parts.

\*This dimension may be modified to suit specific applications.

<sup>1</sup> Guaranteed Z Min is Z Typ -20%

Fair-Rite Products Corp. P.O. Box J, One Commercial Row, Wallkill, NY 12589-0288

Phone: (888) FAIR RITE / (845) 895-2055 • FAX: (888) FERRITE / (845) 895-2629 • www.fair-rite.com • E-Mail: ferrites@fair-rite.com  
(888) 324-7748 (888) 337-7483 Note: (914) Area Code has changed to (845).



# EMI Suppression Beads

Listed in ascending order of "B" dimension.

Dimensions (Bold numbers are in millimeters, light numbers are nominal in inches.)

Typical Impedance( $\Omega$ )<sup>1</sup>

Part Number**	A	B	C*	Wt (g)	H (Oe)	10 MHz	25 MHz	100 MHz	250 MHz
<b>2673030101</b>	<b>1.22 - 0.13</b> .045	<b>0.8+0.1</b> .033	<b>5.3 - 0.45</b> .200	.01	4.1	14	21	-	-
2673025301	<b>1.25 - 0.1</b> .047	<b>0.8+0.1</b> .033	<b>3.8±0.2</b> .150	.01	4.0	10	15	-	-
2673010101	<b>1.95 - 0.25</b> .072	<b>0.8+0.1</b> .033	<b>10.0 - 0.4</b> .384	.08	3.3	55	77	-	-
2643706001	<b>3.5±0.25</b> .138	<b>0.8+0.1</b> .033	<b>2.7 - 0.45</b> .097	.06	2.5	-	26	45	-
2673025001	<b>1.42±0.05</b> .056	<b>0.85+0.1</b> .034	<b>3.8±0.2</b> .150	.02	3.6	12.5	20	-	-
<b>2643020501</b>	<b>1.65±0.025</b> .065	<b>0.85+0.1</b> .034	<b>3.68 - 0.25</b> .140	.02	3.4	-	17	31	-
2673004801	<b>2.1 - 0.15</b> .080	<b>0.85+0.1</b> .034	<b>2.9 - 0.45</b> .105	.03	3.1	20	28	-	-
2643004801	<b>2.1 - 0.15</b> .080	<b>0.85+0.1</b> .034	<b>2.9 - 0.45</b> .105	.03	3.1	-	18	31	-
<b>2673028602</b>	<b>2.13 - 0.1</b> .082	<b>0.85+0.1</b> .034	<b>5.6±0.15</b> .220	.09	2.7	31	50	-	-
<b>2673012401</b>	<b>1.55 - 0.1</b> .059	<b>0.95+0.15</b> .040	<b>4.2 - 0.25</b> .160	.02	3.3	11	19	-	-
2673002201	<b>1.95 - 0.2</b> .072	<b>1.05+0.1</b> .043	<b>10.4±0.25</b> .410	.08	2.9	38	55	-	-
<b>2643002201</b>	<b>1.95 - 0.2</b> .072	<b>1.05+0.1</b> .043	<b>10.4±0.25</b> .410	.08	2.9	-	34	58	-
<b>2673000501</b>	<b>2.0 - 0.15</b> .076	<b>1.05+0.1</b> .043	<b>1.65 - 0.25</b> .060	.01	2.8	7.5	12	-	-
<b>2643000501</b>	<b>2.0 - 0.15</b> .076	<b>1.05+0.1</b> .043	<b>1.65 - 0.25</b> .060	.01	2.8	-	9	22	-
2673000201	<b>2.0 - 0.15</b> .076	<b>1.05+0.1</b> .043	<b>3.8±0.25</b> .150	.03	2.8	18	27	-	-
<b>2643000201</b>	<b>2.0 - 0.15</b> .076	<b>1.05+0.1</b> .043	<b>3.8±0.25</b> .150	.03	2.8	-	16	31	-
<b>2673000101</b>	<b>3.5±0.2</b> .138	<b>1.3±0.1</b> .051	<b>3.25±0.25</b> .128	.10	2.0	25	35	-	-
<b>2643000101</b>	<b>3.5±0.2</b> .138	<b>1.3±0.1</b> .051	<b>3.25±0.25</b> .128	.10	2.0	-	26	40	-
2661000101	<b>3.5±0.2</b> .138	<b>1.3±0.1</b> .051	<b>3.25±0.25</b> .128	.10	2.0	-	-	27.5	43
<b>2673000301</b>	<b>3.5±0.2</b> .138	<b>1.3±0.1</b> .051	<b>6.0±0.25</b> .236	.18	2.0	44	62	-	-
<b>2643000301</b>	<b>3.5±0.2</b> .138	<b>1.3±0.1</b> .051	<b>6.0±0.25</b> .236	.18	2.0	-	46	60	-

\*\*Bold part numbers designate preferred parts.

\*This dimension may be modified to suit specific applications.

<sup>1</sup> Guaranteed Z Min is Z Typ -20%

# EMI Suppression Beads

Listed in ascending order of "B" dimension.

Dimensions (Bold numbers are in millimeters, light numbers are nominal in inches.)

Typical Impedance( $\Omega$ )<sup>1</sup>

Part Number**	A	B	C*	Wt (g)	H (Oe)	10 MHz	25 MHz	100 MHz	250 MHz
2661000301	<b>3.5±0.2</b> .138	<b>1.3±0.1</b> .051	<b>6.0±0.25</b> .236	.18	2.0	-	-	50	70
2673000701	<b>3.5±0.2</b> .138	<b>1.3±0.1</b> .051	<b>12.7±0.35</b> .500	.38	2.0	87	125	-	-
2643000701	<b>3.5±0.2</b> .138	<b>1.3±0.1</b> .051	<b>12.7±0.35</b> .500	.38	2.0	-	89	125	-
2661000701	<b>3.5±0.2</b> .138	<b>1.3±0.1</b> .051	<b>12.7±0.35</b> .500	.38	2.0	-	-	125	170
2643200101	<b>5.1±0.25</b> .200	<b>1.45±0.25</b> .062	<b>3.4 - 0.45</b> .125	.19	1.5	-	30	41	-
2673022401	<b>5.1±0.25</b> .200	<b>1.45±0.25</b> .062	<b>6.35±0.25</b> .250	.38	1.5	54	58	-	-
2643022401	<b>5.1±0.25</b> .200	<b>1.45±0.25</b> .062	<b>6.35±0.25</b> .250	.38	1.5	-	55	82	-
2661022401	<b>5.1±0.25</b> .200	<b>1.45±0.25</b> .062	<b>6.35±0.25</b> .250	.38	1.5	-	-	56	85
2673021801	<b>5.1±0.25</b> .200	<b>1.45±0.25</b> .062	<b>11.1±0.35</b> .437	.67	1.5	94	95	-	-
2643021801	<b>5.1±0.25</b> .200	<b>1.45±0.25</b> .062	<b>11.1±0.35</b> .437	.67	1.5	-	96	131	-
2661021801	<b>5.1±0.25</b> .200	<b>1.45±0.25</b> .062	<b>11.1±0.35</b> .437	.67	1.5	-	-	119	163
2643023801	<b>5.1±0.25</b> .200	<b>1.45±0.25</b> .062	<b>22.85±0.75</b> .900	1.4	1.5	-	192	266	-
2661023801	<b>5.1±0.25</b> .200	<b>1.45±0.25</b> .062	<b>22.85±0.75</b> .900	1.4	1.5	-	-	238	326
<b>2643001501</b>	<b>3.5±0.2</b> .138	<b>1.6±0.1</b> .063	<b>3.25±0.25</b> .128	.10	1.7	-	21	35	-
2643025601	<b>3.5±0.2</b> .138	<b>1.6±0.1</b> .063	<b>6.0±0.25</b> .236	.18	1.7	-	38	55	-
2643023201	<b>2.85±0.1</b> .112	<b>1.65±0.15</b> .068	<b>3.75±0.25</b> .147	.06	1.8	-	15	30	-
2673018001	<b>2.85±0.1</b> .112	<b>1.65±0.15</b> .068	<b>6.65±0.25</b> .262	.12	1.8	29	41	-	-
2673004901	<b>2.85±0.1</b> .112	<b>1.65±0.15</b> .068	<b>10.45±0.25</b> .410	.18	1.8	40	58	-	-
2643013801	<b>3.5±0.2</b> .138	<b>1.65±0.25</b> .070	<b>4.05±0.25</b> .160	.12	1.6	-	24	38	-
2673001601	<b>3.55±0.15</b> .140	<b>1.65±0.25</b> .070	<b>3.3 - 0.4</b> .122	.09	1.6	16	24	-	-
2643001601	<b>3.55±0.15</b> .140	<b>1.65±0.25</b> .070	<b>3.3 - 0.4</b> .122	.09	1.6	-	19	30	-

\*\*Bold part numbers designate preferred parts.

<sup>1</sup> Guaranteed Z Min is Z Typ -20%

\*This dimension may be modified to suit specific applications.

Fair-Rite Products Corp. P.O. Box J, One Commercial Row, Wallkill, NY 12589-0288

Phone: (888) FAIR RITE / (845) 895-2055 • FAX: (888) FERRITE / (845) 895-2629 • www.fair-rite.com • E-Mail: ferrites@fair-rite.com  
(888) 324-7748 (888) 337-7483 Note: (914) Area Code has changed to (845).

# EMI Suppression Beads

Listed in ascending order of "B" dimension.

Dimensions (Bold numbers are in millimeters, light numbers are nominal in inches.)

Typical Impedance( $\Omega$ )<sup>1</sup>

Part Number**	A	B	C*	Wt (g)	H (Oe)	10 MHz	25 MHz	100 MHz	250 MHz
2643001301	<b>3.55±0.15</b> .140	<b>1.65±0.25</b> .070	<b>5.95±0.25</b> .234	.18	1.6	-	31	48	-
<b>2673015301</b>	<b>4.1 - 0.25</b> .156	<b>1.8±0.15</b> .071	<b>6.85±0.25</b> .270	.26	1.5	41	54	-	-
<b>2643005701</b>	<b>5.1±0.25</b> .200	<b>2.3±0.2</b> .090	<b>12.7±0.35</b> .500	.81	1.2	-	78	120	-
<b>2673000801</b>	<b>7.5±0.25</b> .296	<b>2.25±0.25</b> .094	<b>7.55±0.25</b> .297	1.0	1.0	48	52	-	-
<b>2643000801</b>	<b>7.5±0.25</b> .296	<b>2.25±0.25</b> .094	<b>7.55±0.25</b> .297	1.0	1.0	-	63	92	-
2643300101	<b>7.6±0.25</b> .300	<b>2.25±0.25</b> .094	<b>15.1±0.75</b> .595	2.1	1.0	-	115	200	-
2673200201	<b>5.2±0.15</b> .205	<b>2.65±0.25</b> .105	<b>20.6±0.75</b> .812	1.3	1.1	88	125	-	-
<b>2673003201</b>	<b>5.6 - 0.5</b> .210	<b>2.65±0.25</b> .105	<b>12.7±0.5</b> .500	.87	1.1	59	85	-	-
<b>2643003201</b>	<b>5.6 - 0.5</b> .210	<b>2.65±0.25</b> .105	<b>12.7±0.5</b> .500	.87	1.1	-	63	88	-
<b>2643250402</b>	<b>6.35±0.15</b> .250	<b>2.95±0.45</b> .125	<b>12.7±0.5</b> .500	1.2	.91	-	69	102	-
<b>2643250302</b>	<b>6.35±0.15</b> .250	<b>2.95±0.45</b> .125	<b>15.9±0.5</b> .625	1.5	.91	-	85	122	-
2631250202	<b>6.35±0.15</b> .250	<b>2.95±0.45</b> .125	<b>25.4±0.75</b> 1.000	2.5	.91	90	138	230	-
<b>2643250202</b>	<b>6.35±0.15</b> .250	<b>2.95±0.45</b> .125	<b>25.4±0.75</b> 1.000	2.5	.91	-	135	200	-
2643375102	<b>9.5±0.25</b> .375	<b>4.5±0.75</b> .192	<b>6.35±0.35</b> .250	1.4	.60	-	35	50	-
2643375002	<b>9.5±0.25</b> .375	<b>4.5±0.75</b> .192	<b>14.5±0.6</b> .570	3.1	.60	-	78	115	-
<b>2643006302</b>	<b>9.5±0.25</b> .375	<b>4.75±0.3</b> .193	<b>10.4±0.25</b> .410	2.2	.60	-	53	80	-
2643023402	<b>9.5±0.25</b> .375	<b>4.75±0.3</b> .193	<b>15.9±0.45</b> .625	3.4	.60	-	83	120	-
<b>2643023002</b>	<b>9.5±0.25</b> .375	<b>4.75±0.3</b> .193	<b>19.05±0.7</b> .750	4.1	.60	-	100	145	-
2673002402	<b>9.65±0.25</b> .380	<b>5.0±0.2</b> .197	<b>5.05 - 0.45</b> .190	1.1	.59	19	20	-	-
<b>2643002402</b>	<b>9.65±0.25</b> .380	<b>5.0±0.2</b> .197	<b>5.05 - 0.45</b> .190	1.1	.59	-	26	43	-
2643012702	<b>9.65±0.25</b> .380	<b>6.35±0.15</b> .250	<b>7.35±0.25</b> .290	1.3	.51	-	24	38	-

\*\*Bold part numbers designate preferred parts.

<sup>1</sup>Guaranteed Z Min is Z Typ -20%

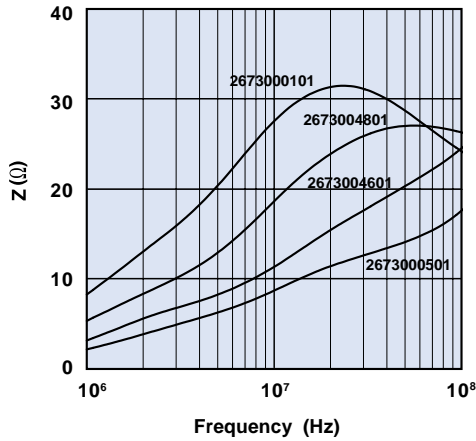
\*This dimension may be modified to suit specific applications.

P.O. Box J, One Commercial Row, Wallkill, NY 12589-0288

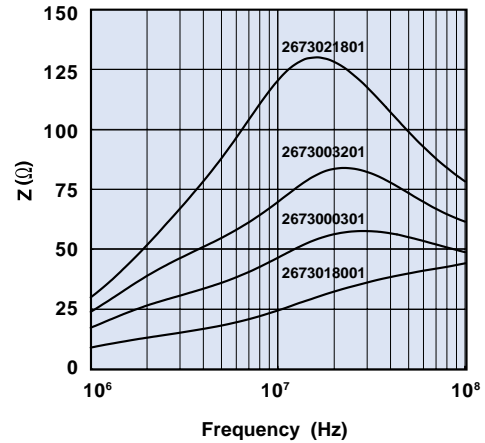
Fair-Rite Products Corp.

Phone: (888) FAIR RITE / (845) 895-2055 • FAX: (888) FERRITE / (845) 895-2629 • www.fair-rite.com • E-Mail: ferrites@fair-rite.com  
(888) 324-7748 (888) 337-7483 Note: (914) Area Code has changed to (845).

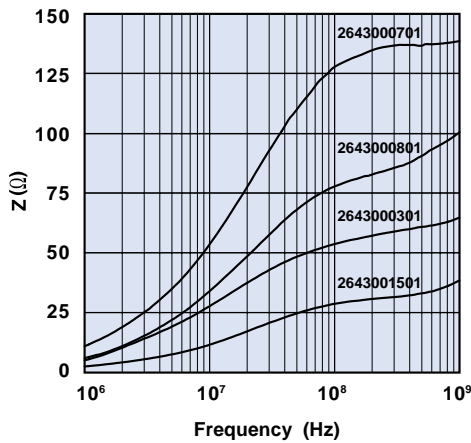
# EMI Suppression Beads



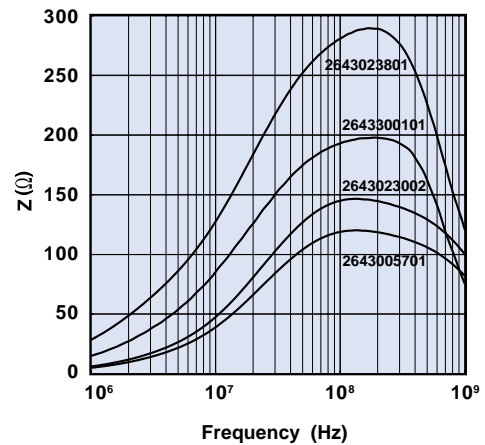
**Figure 1** Impedance vs. Frequency for 73 material EMI suppression beads.



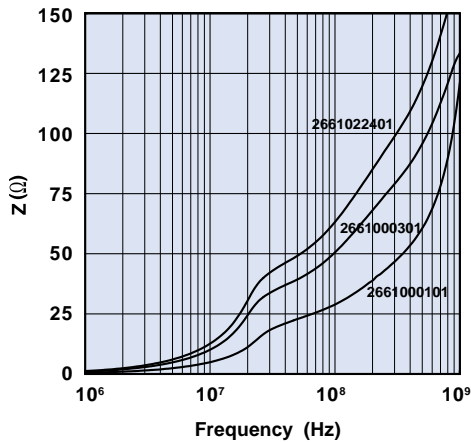
**Figure 2** Impedance vs. Frequency for 73 material EMI suppression beads.



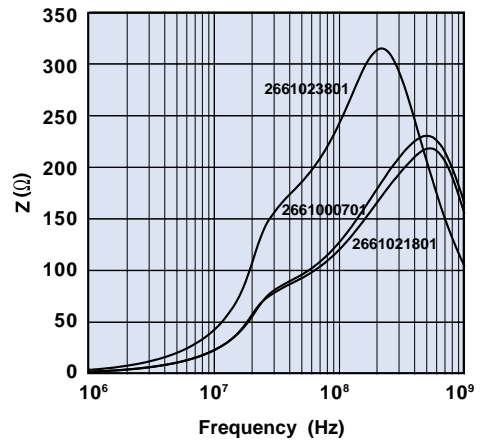
**Figure 3** Impedance vs. Frequency for 43 material EMI suppression beads.



**Figure 4** Impedance vs. Frequency for 43 material EMI suppression beads.



**Figure 5** Impedance vs. Frequency for 61 material EMI suppression beads.

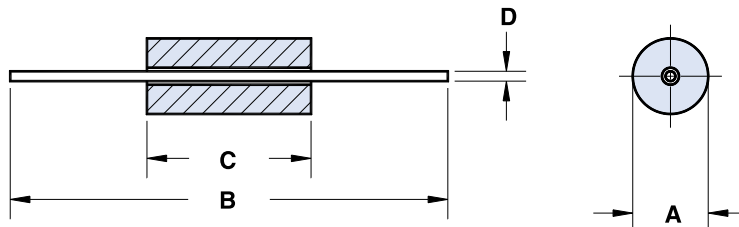


**Figure 6** Impedance vs. Frequency for 61 material EMI suppression beads.

# Beads on Leads

Beads are supplied assembled on tinned copper wire to aid automated circuit assembly.

- Parts with a "2" as the last digit of the part number are supplied taped and reeled per IEC 60286-1 and EIA Standard RS-296-F. Taped and reeled parts are supplied 4500 pieces on a 14" reel. Inside tape spacing is **52.4±1.5 mm**. These parts can also be supplied not taped and reeled and are then bulk packed. The last digit of bulk packaged part number is a "1".



- Wires are oxygen free high conductivity copper with a tin/lead coating. The resistance of the wire is 3.5 mΩ maximum for the 22 AWG wire and 2.2 mΩ maximum for the 20 AWG wire.
- Beads are controlled for impedance limits only. They are tested for impedance with a single turn, using a Hewlett Packard HP 4193A Vector Impedance Meter for beads in 73 and 43 material and the HP 4191A RF Impedance Analyzer for 61 material beads.
- Recommended storage and operating temperature is -55°C to 125°C.
- For impedance vs. frequency curves and DC bias curves for these parts, see Figures 1-30.
- For any bead on lead requirement not listed in the catalog, please contact our customer service group for availability and pricing.
- The Bead on Lead EMI Suppressor Kit (part number 0199000028) is available for prototype evaluation. See page 92.

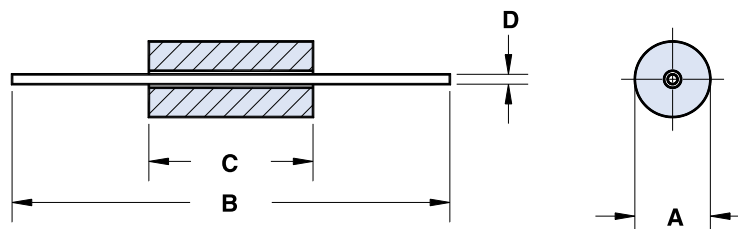
**Dimensions** (Bold numbers are in millimeters, light numbers are nominal in inches.)

Part Number*	A	B	C	D	Wt (g)	Typical Impedance(Ω) <sup>1</sup>				Z, R <sub>s</sub> , X <sub>L</sub> vs. Frequency Curve	DC Bias Curve
						10 MHz	25 MHz	100 MHz	250 MHz		
<b>2773001112</b>	<b>3.5±0.25</b> .138	<b>62.0±1.5</b> 2.440	<b>4.45±0.25</b> .175	<b>0.65</b> 22 AWG	.4	48	61	—	—	Figure 1A	Figure 1B
<b>2743001112</b>	<b>3.5±0.25</b> .138	<b>62.0±1.5</b> 2.440	<b>4.45±0.25</b> .175	<b>0.65</b> 22 AWG	.4	—	49	68	—	Figure 2A	Figure 2B
<b>2761001112</b>	<b>3.5±0.25</b> .138	<b>62.0±1.5</b> 2.440	<b>4.45±0.25</b> .175	<b>0.65</b> 22 AWG	.4	—	—	56	80	Figure 3A	Figure 3B
<b>2773015112</b>	<b>3.5±0.25</b> .138	<b>62.0±1.5</b> 2.440	<b>5.25±0.25</b> .206	<b>0.65</b> 22 AWG	.4	55	68	—	—	Figure 4A	Figure 4B
<b>2743015112</b>	<b>3.5±0.25</b> .138	<b>62.0±1.5</b> 2.440	<b>5.25±0.25</b> .206	<b>0.65</b> 22 AWG	.4	—	54	82	—	Figure 5A	Figure 5B
<b>2761015112</b>	<b>3.5±0.25</b> .138	<b>62.0±1.5</b> 2.440	<b>5.25±0.25</b> .206	<b>0.65</b> 22 AWG	.4	—	—	69	100	Figure 6A	Figure 6B
<b>2773005112</b>	<b>3.5±0.25</b> .138	<b>62.0±1.5</b> 2.440	<b>6.0±0.25</b> .236	<b>0.65</b> 22 AWG	.4	63	78	—	—	Figure 7A	Figure 7B
<b>2743005112</b>	<b>3.5±0.25</b> .138	<b>62.0±1.5</b> 2.440	<b>6.0±0.25</b> .236	<b>0.65</b> 22 AWG	.4	—	60	91	—	Figure 8A	Figure 8B
<b>2761005112</b>	<b>3.5±0.25</b> .138	<b>62.0±1.5</b> 2.440	<b>6.0±0.25</b> .236	<b>0.65</b> 22 AWG	.4	—	—	75	113	Figure 9A	Figure 9B
<b>2773003112</b>	<b>3.5±0.25</b> .138	<b>62.0±1.5</b> 2.440	<b>6.7±0.25</b> .263	<b>0.65</b> 22 AWG	.5	70	86	—	—	Figure 10A	Figure 10B

\* Bold part numbers designate preferred parts.

<sup>1</sup>Guaranteed Z Min is Z Typ -20%

# Beads on Leads



Dimensions (Bold numbers are in millimeters, light numbers are nominal in inches.)

Part Number*	A	B	C	D	Wt (g)	Typical Impedance( $\Omega$ ) <sup>1</sup>				Z, R <sub>s</sub> , X <sub>L</sub> vs. Frequency Curve	DC Bias Curve
						10 MHz	25 MHz	100 MHz	250 MHz		
<b>2743003112</b>	<b>3.5±0.25</b> .138	<b>62.0±1.5</b> 2.440	<b>6.7±0.25</b> .263	<b>0.65</b> 22 AWG	.5	–	65	100	–	Figure 11A	Figure 11B
<b>2761003112</b>	<b>3.5±0.25</b> .138	<b>62.0±1.5</b> 2.440	<b>6.7±0.25</b> .263	<b>0.65</b> 22 AWG	.5	–	–	88	125	Figure 12A	Figure 12B
<b>2773004112</b>	<b>3.5±0.25</b> .138	<b>62.0±1.5</b> 2.440	<b>7.6±0.3</b> .300	<b>0.65</b> 22 AWG	.5	80	100	–	–	Figure 13A	Figure 13B
<b>2743004112</b>	<b>3.5±0.25</b> .138	<b>62.0±1.5</b> 2.440	<b>7.6±0.3</b> .300	<b>0.65</b> 22 AWG	.5	–	75	110	–	Figure 14A	Figure 14B
<b>2761004112</b>	<b>3.5±0.25</b> .138	<b>62.0±1.5</b> 2.440	<b>7.6±0.3</b> .300	<b>0.65</b> 22 AWG	.5	–	–	94	144	Figure 15A	Figure 15B
<b>2773002112</b>	<b>3.5±0.25</b> .138	<b>62.0±1.5</b> 2.440	<b>8.9±0.3</b> .350	<b>0.65</b> 22 AWG	.6	94	115	–	–	Figure 16A	Figure 16B
<b>2743002112</b>	<b>3.5±0.25</b> .138	<b>62.0±1.5</b> 2.440	<b>8.9±0.3</b> .350	<b>0.65</b> 22 AWG	.6	–	88	133	–	Figure 17A	Figure 17B
<b>2761002112</b>	<b>3.5±0.25</b> .138	<b>62.0±1.5</b> 2.440	<b>8.9±0.3</b> .350	<b>0.65</b> 22 AWG	.6	–	–	113	168	Figure 18A	Figure 18B
<b>2773007112</b>	<b>3.5±0.25</b> .138	<b>62.0±1.5</b> 2.440	<b>9.5±0.3</b> .374	<b>0.65</b> 22 AWG	.6	110	115	–	–	Figure 19A	Figure 19B
<b>2743007112</b>	<b>3.5±0.25</b> .138	<b>62.0±1.5</b> 2.440	<b>9.5±0.3</b> .374	<b>0.65</b> 22 AWG	.6	–	96	150	–	Figure 20A	Figure 20B
<b>2761007112</b>	<b>3.5±0.25</b> .138	<b>62.0±1.5</b> 2.440	<b>9.5±0.3</b> .374	<b>0.65</b> 22 AWG	.6	–	–	125	180	Figure 21A	Figure 21B
<b>2773008112</b>	<b>3.5±0.25</b> .138	<b>62.0±1.5</b> 2.440	<b>11.4±0.4</b> .450	<b>0.65</b> 22 AWG	.7	125	145	–	–	Figure 22A	Figure 22B
<b>2743008112</b>	<b>3.5±0.25</b> .138	<b>62.0±1.5</b> 2.440	<b>11.4±0.4</b> .450	<b>0.65</b> 22 AWG	.7	–	116	180	–	Figure 23A	Figure 23B
<b>2761008112</b>	<b>3.5±0.25</b> .138	<b>62.0±1.5</b> 2.440	<b>11.4±0.4</b> .450	<b>0.65</b> 22 AWG	.7	–	–	144	213	Figure 24A	Figure 24B
<b>2773009112</b>	<b>3.5±0.25</b> .138	<b>62.0±1.5</b> 2.440	<b>13.8±0.5</b> .545	<b>0.65</b> 22 AWG	.8	151	170	–	–	Figure 25A	Figure 25B
<b>2743009112</b>	<b>3.5±0.25</b> .138	<b>62.0±1.5</b> 2.440	<b>13.8±0.5</b> .545	<b>0.65</b> 22 AWG	.8	–	143	220	–	Figure 26A	Figure 26B
<b>2761009112</b>	<b>3.5±0.25</b> .138	<b>62.0±1.5</b> 2.440	<b>13.8±0.5</b> .545	<b>0.65</b> 22 AWG	.8	–	–	175	258	Figure 27A	Figure 27B
<b>2743012201+</b>	<b>9.8±0.3</b> .385	<b>62.0±1.5</b> 2.440	<b>11.4±0.4</b> .449	<b>0.8</b> 20 AWG	4.5	–	193	271	–	Figure 28A	Figure 28B
<b>2743013211+</b>	<b>9.8±0.3</b> .385	<b>62.0±1.5</b> 2.440	<b>14.0±0.5</b> .550	<b>0.8</b> 20 AWG	5.5	–	235	331	–	Figure 29A	Figure 29B
<b>2743014221+</b>	<b>9.8±0.3</b> .385	<b>62.0±1.5</b> 2.440	<b>16.5±0.5</b> .650	<b>0.8</b> 20 AWG	6.5	–	280	391	–	Figure 30A	Figure 30B

\* Bold part numbers designate preferred parts.

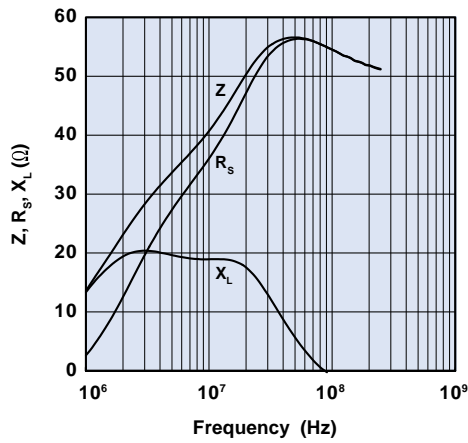
+ Not available taped and reeled.

<sup>1</sup>Guaranteed Z Min is Z Typ -20%

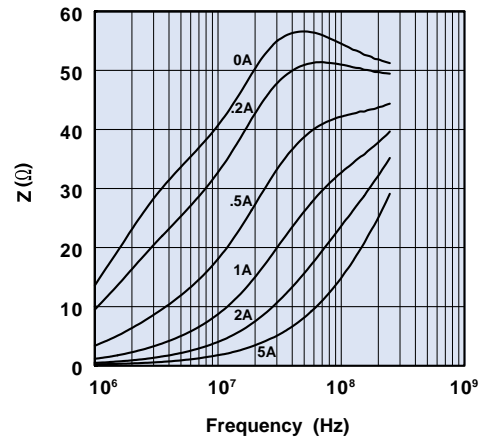
Fair-Rite Products Corp. P.O. Box J, One Commercial Row, Wallkill, NY 12589-0288

Phone: (888) FAIR RITE / (845) 895-2055 • FAX: (888) FERRITE / (845) 895-2629 • www.fair-rite.com • E-Mail: ferrites@fair-rite.com  
(888) 324-7748 (888) 337-7483 Note: (914) Area Code has changed to (845).

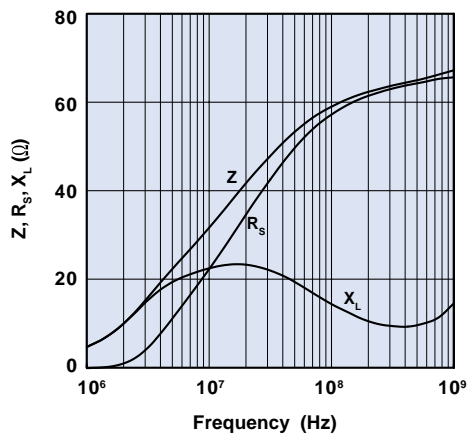
# Beads on Leads



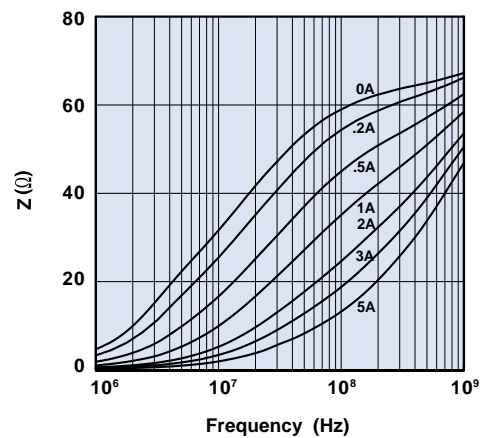
**Figure 1A** Impedance, reactance, and resistance vs. frequency for bead on lead 2773001112.



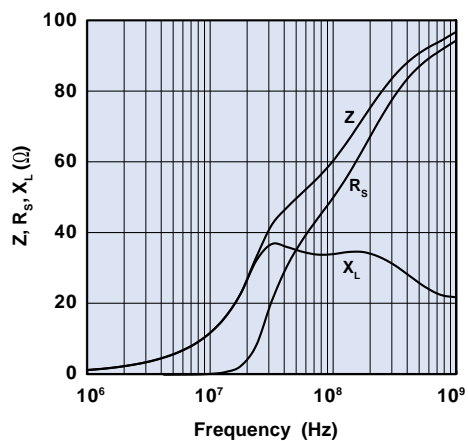
**Figure 1B** Impedance vs. frequency with dc bias as parameter for bead on lead 2773001112.



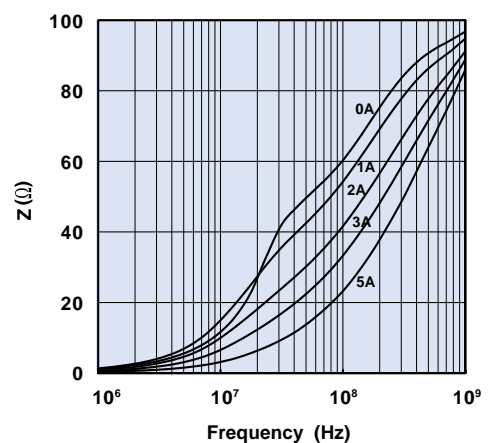
**Figure 2A** Impedance, reactance, and resistance vs. frequency for bead on lead 2743001112.



**Figure 2B** Impedance vs. frequency with dc bias as parameter for bead on lead 2743001112.

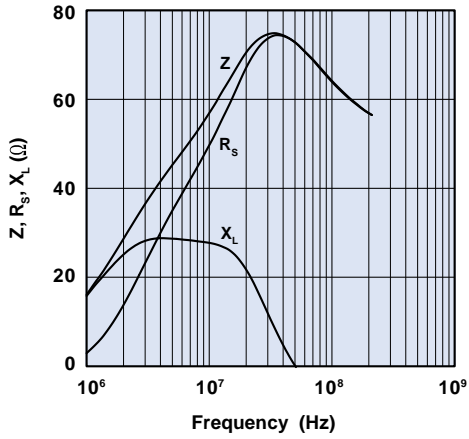


**Figure 3A** Impedance, reactance, and resistance vs. frequency for bead on lead 2761001112.

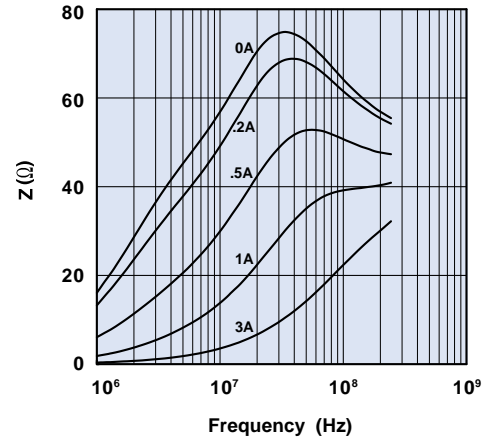


**Figure 3B** Impedance vs. frequency with dc bias as parameter for bead on lead 2761001112.

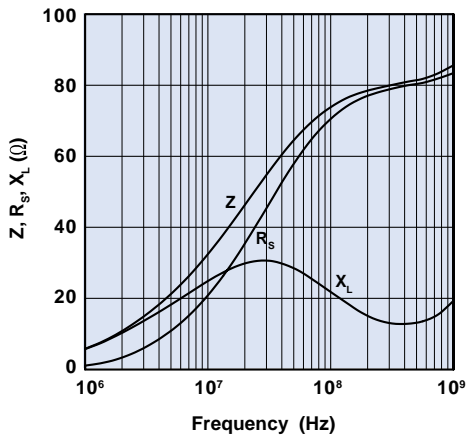
# Beads on Leads



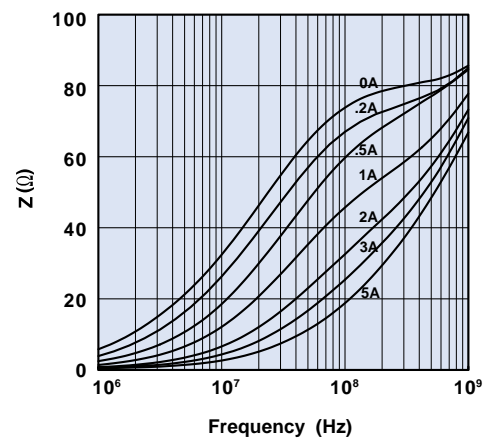
**Figure 4A** Impedance, reactance, and resistance vs. frequency for bead on lead 2773015112.



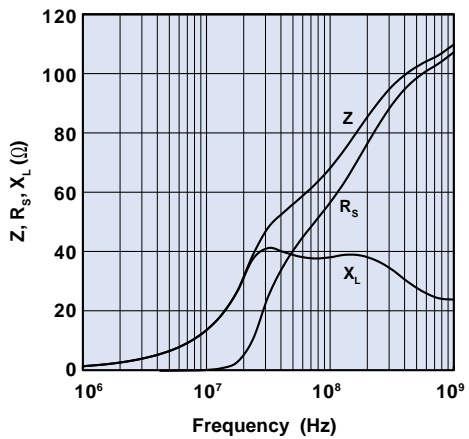
**Figure 4B** Impedance vs. frequency with dc bias as parameter for bead on lead 2773015112.



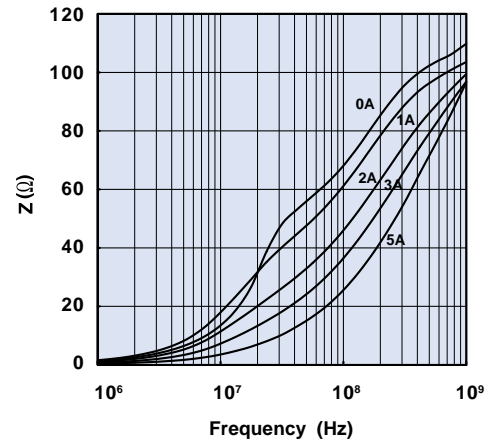
**Figure 5A** Impedance, reactance, and resistance vs. frequency for bead on lead 2743015112.



**Figure 5B** Impedance vs. frequency with dc bias as parameter for bead on lead 2743015112.



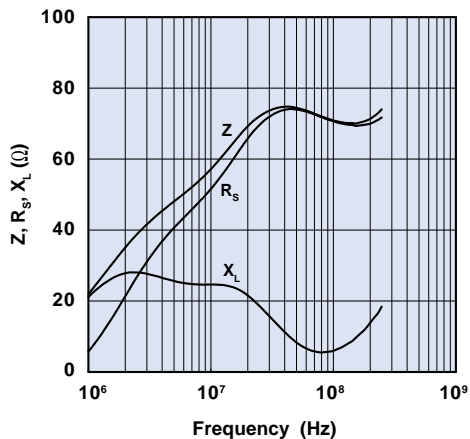
**Figure 6A** Impedance, reactance, and resistance vs. frequency for bead on lead 2761015112.



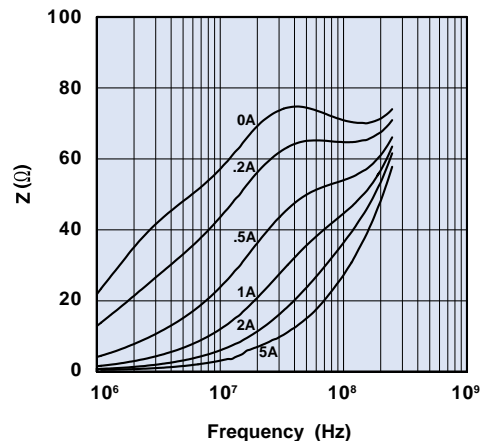
**Figure 6B** Impedance vs. frequency with dc bias as parameter for bead on lead 2761015112.



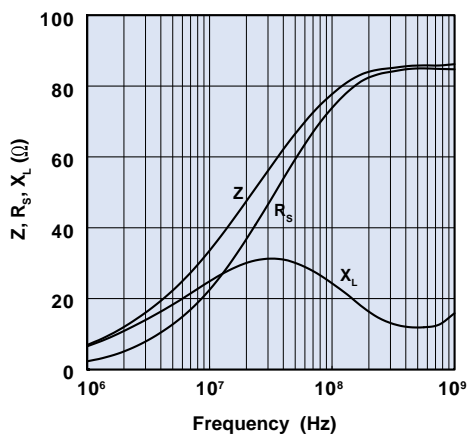
# Beads on Leads



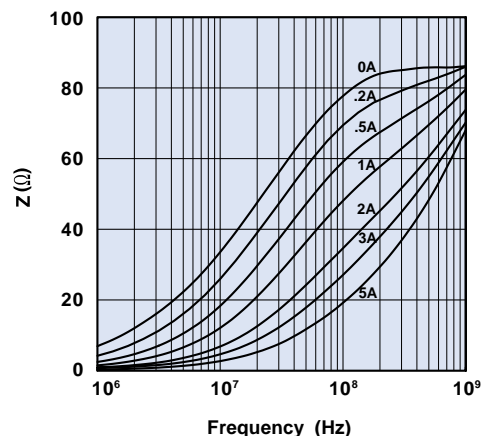
**Figure 7A** Impedance, reactance, and resistance vs. frequency for bead on lead 2773005112.



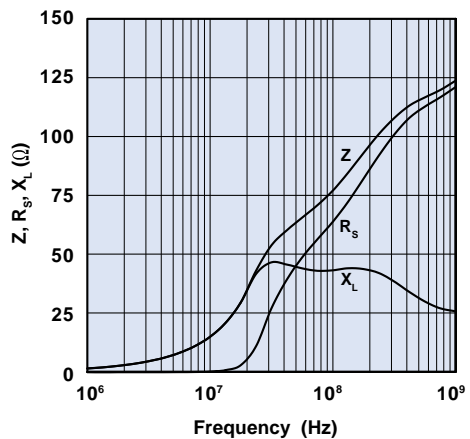
**Figure 7B** Impedance vs. frequency with dc bias as parameter for bead on lead 2773005112.



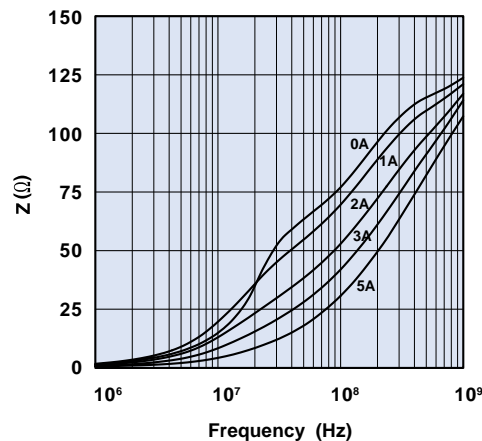
**Figure 8A** Impedance, reactance, and resistance vs. frequency for bead on lead 2743005112.



**Figure 8B** Impedance vs. frequency with dc bias as parameter for bead on lead 2743005112.

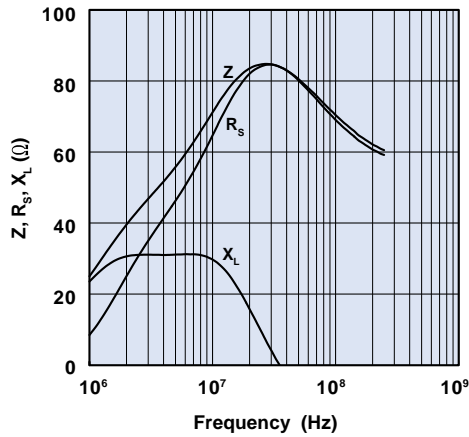


**Figure 9A** Impedance, reactance, and resistance vs. frequency for bead on lead 2761005112.

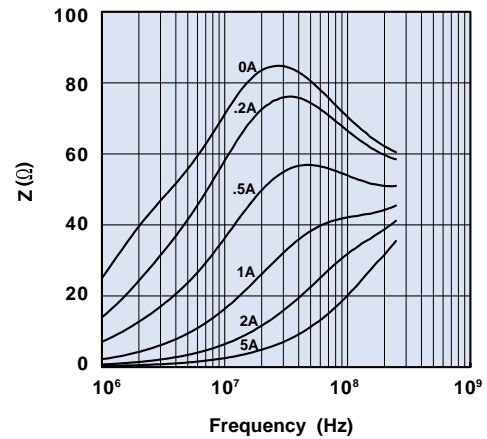


**Figure 9B** Impedance vs. frequency with dc bias as parameter for bead on lead 2761005112.

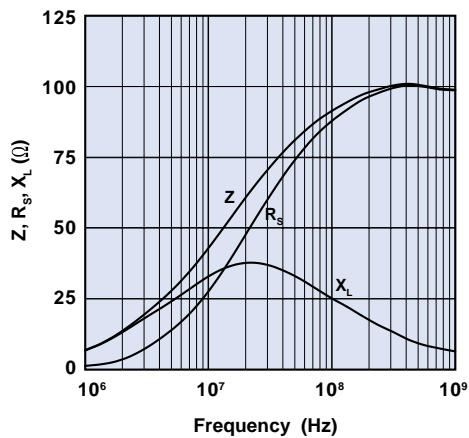
# Beads on Leads



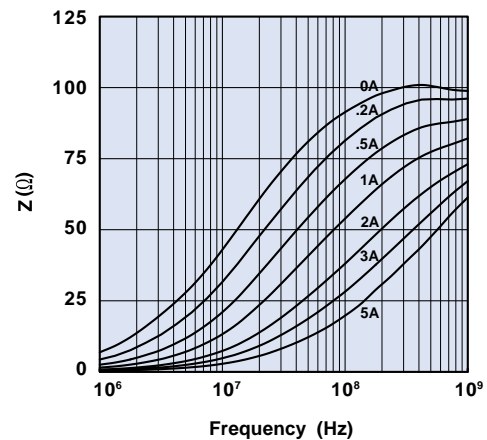
**Figure 10A** Impedance, reactance, and resistance vs. frequency for bead on lead 2773003112.



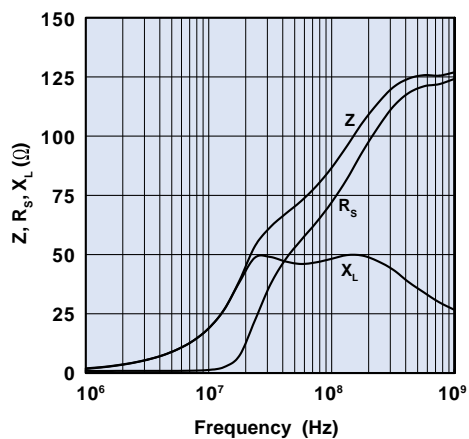
**Figure 10B** Impedance vs. frequency with dc bias as parameter for bead on lead 2773003112.



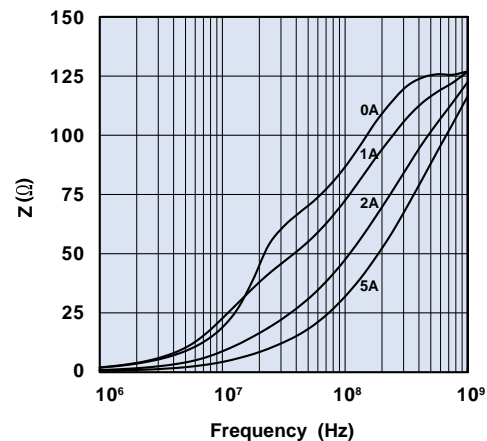
**Figure 11A** Impedance, reactance, and resistance vs. frequency for bead on lead 2743003112.



**Figure 11B** Impedance vs. frequency with dc bias as parameter for bead on lead 2743003112.

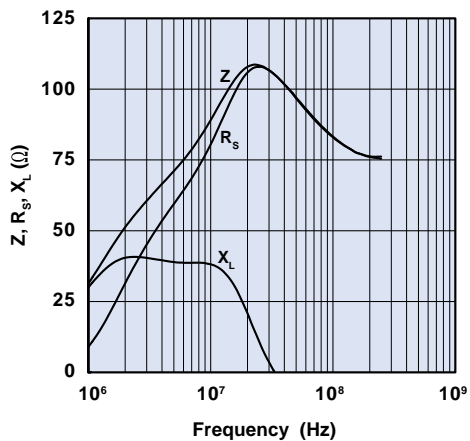


**Figure 12A** Impedance, reactance, and resistance vs. frequency for bead on lead 2761003112.

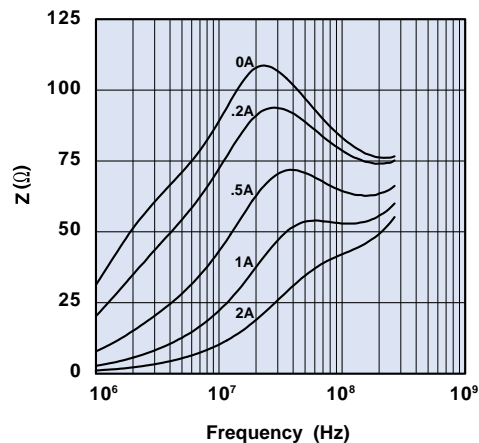


**Figure 12B** Impedance vs. frequency with dc bias as parameter for bead on lead 2761003112.

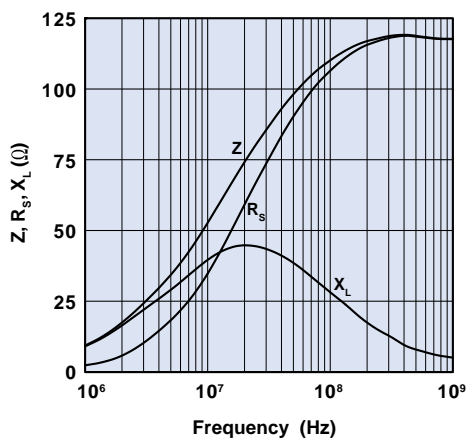
# Beads on Leads



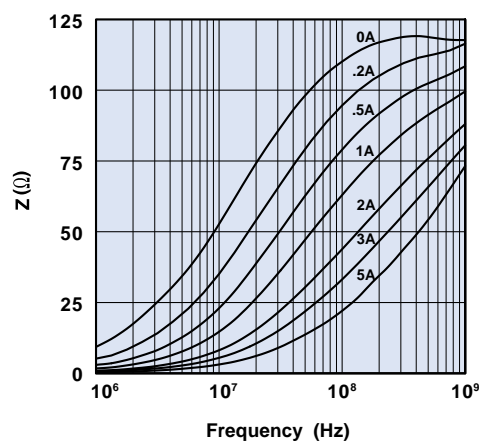
**Figure 13A** Impedance, reactance, and resistance vs. frequency for bead on lead 2773004112.



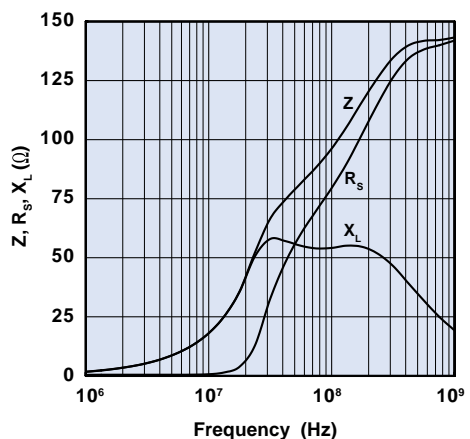
**Figure 13B** Impedance vs. frequency with dc bias as parameter for bead on lead 2773004112.



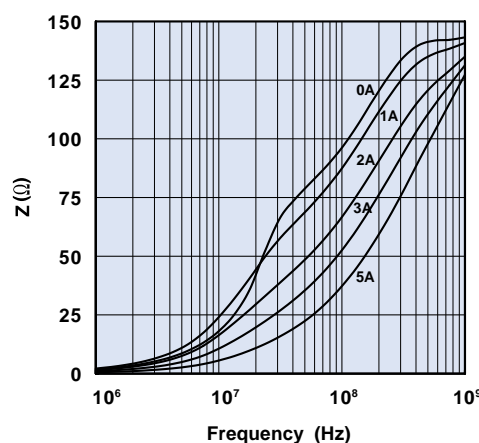
**Figure 14A** Impedance, reactance, and resistance vs. frequency for bead on lead 2743004112.



**Figure 14B** Impedance vs. frequency with dc bias as parameter for bead on lead 2743004112.

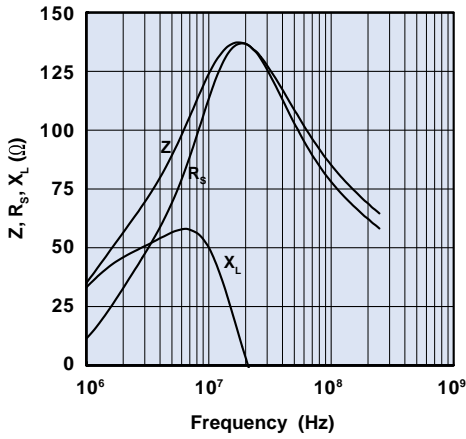


**Figure 15A** Impedance, reactance, and resistance vs. frequency for bead on lead 2761004112.

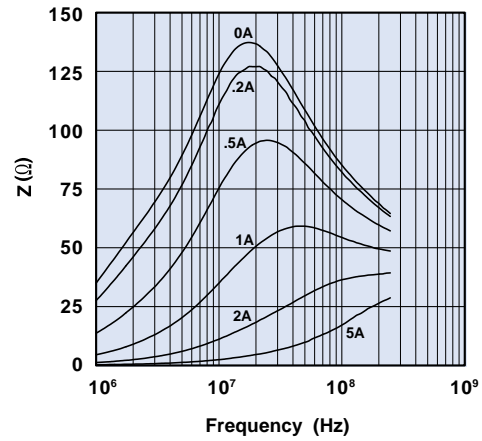


**Figure 15B** Impedance vs. frequency with dc bias as parameter for bead on lead 2761004112.

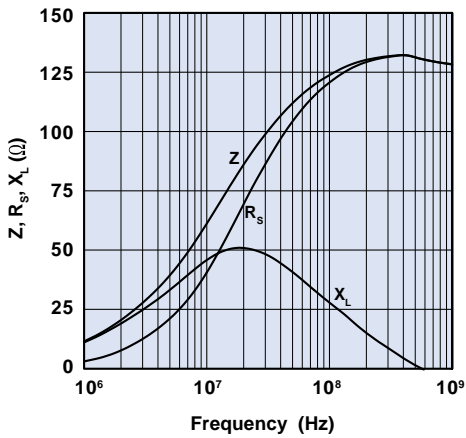
# Beads on Leads



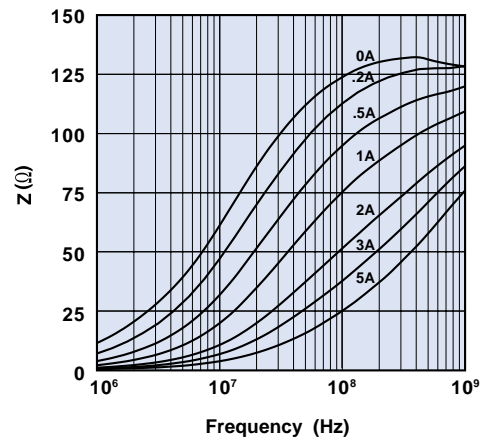
**Figure 16A** Impedance, reactance, and resistance vs. frequency for bead on lead 2773002112.



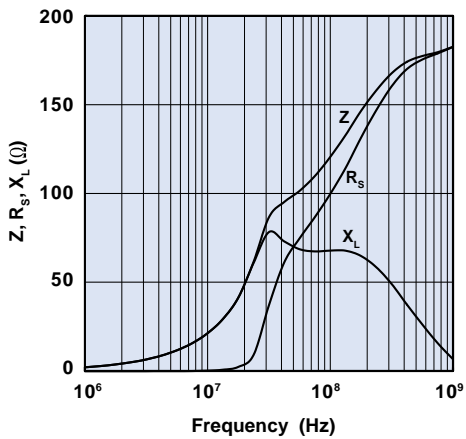
**Figure 16B** Impedance vs. frequency with dc bias as parameter for bead on lead 2773002112.



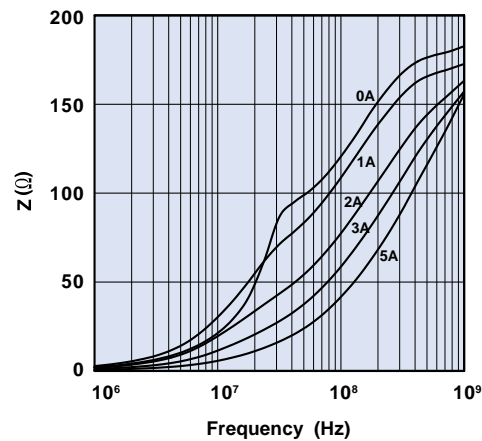
**Figure 17A** Impedance, reactance, and resistance vs. frequency for bead on lead 2743002112.



**Figure 17B** Impedance vs. frequency with dc bias as parameter for bead on lead 2743002112.

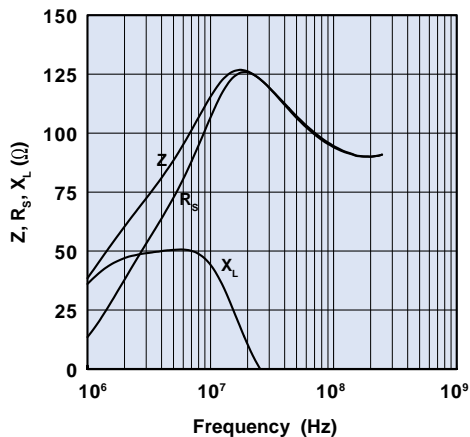


**Figure 18A** Impedance, reactance, and resistance vs. frequency for bead on lead 2761002112.

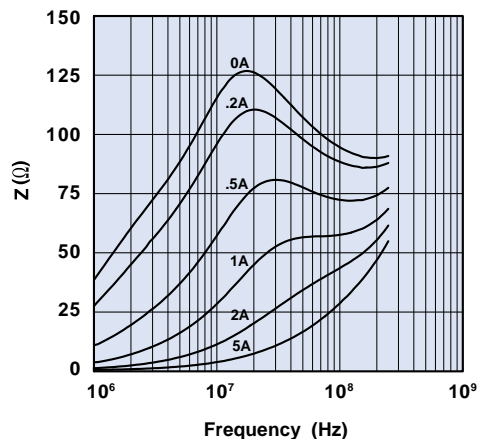


**Figure 18B** Impedance vs. frequency with dc bias as parameter for bead on lead 2761002112.

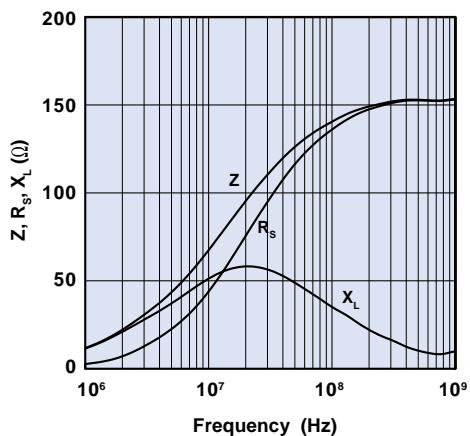
# Beads on Leads



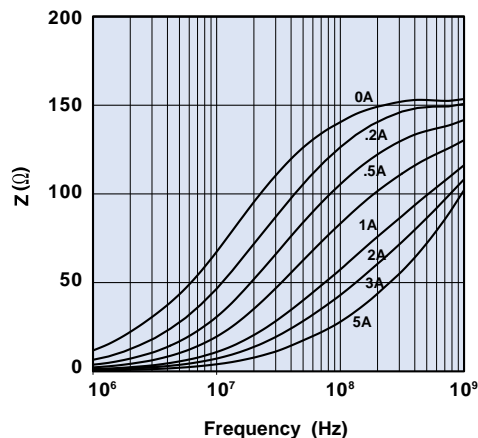
**Figure 19A** Impedance, reactance, and resistance vs. frequency for bead on lead 2773007112.



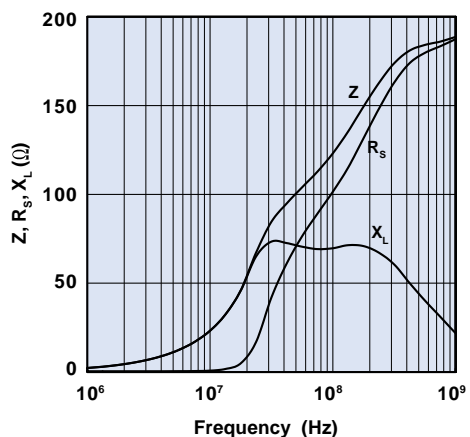
**Figure 19B** Impedance vs. frequency with dc bias as parameter for bead on lead 2773007112.



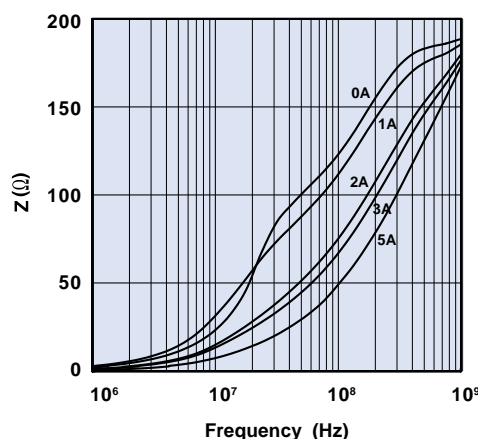
**Figure 20A** Impedance, reactance, and resistance vs. frequency for bead on lead 2743007112.



**Figure 20B** Impedance vs. frequency with dc bias as parameter for bead on lead 2743007112.



**Figure 21A** Impedance, reactance, and resistance vs. frequency for bead on lead 2761007112.



**Figure 21B** Impedance vs. frequency with dc bias as parameter for bead on lead 2761007112.

# Beads on Leads

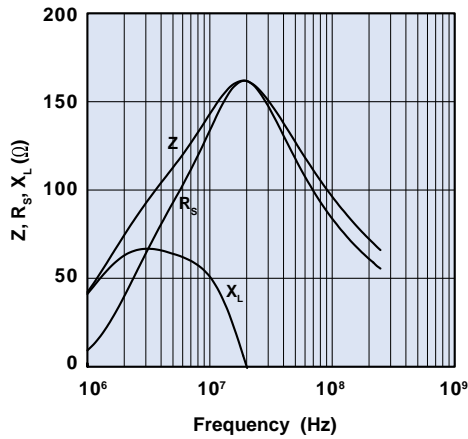


Figure 22A Impedance, reactance, and resistance vs. frequency for bead on lead 2773008112.

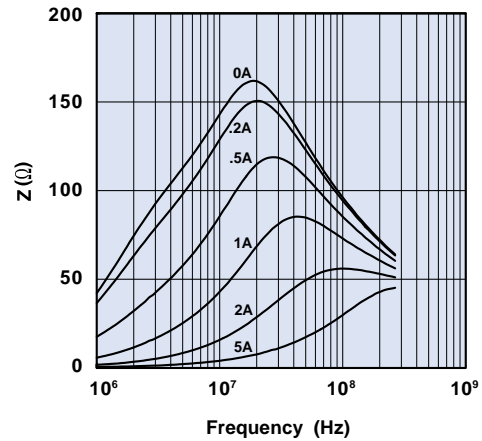


Figure 22B Impedance vs. frequency with dc bias as parameter for bead on lead 2773008112.

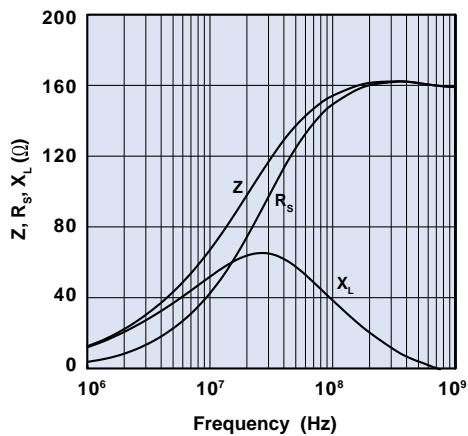


Figure 23A Impedance, reactance, and resistance vs. frequency for bead on lead 2743008112.

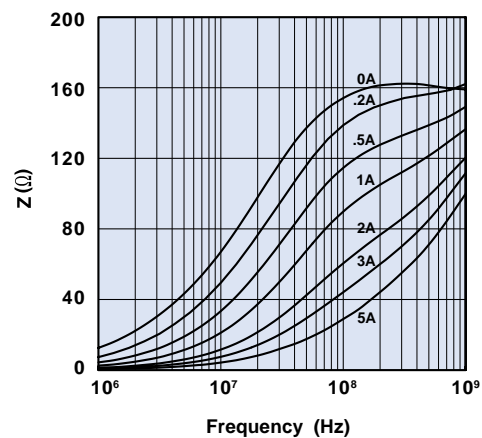


Figure 23B Impedance vs. frequency with dc bias as parameter for bead on lead 2743008112.

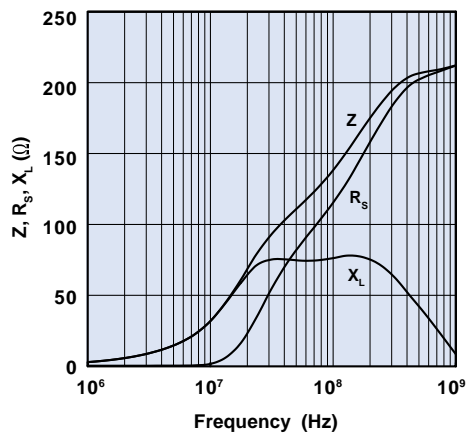


Figure 24A Impedance, reactance, and resistance vs. frequency for bead on lead 2761008112.

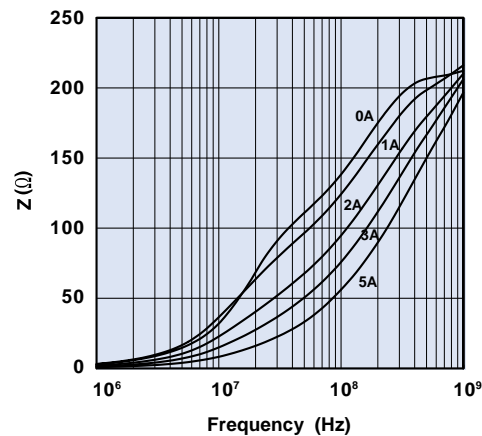
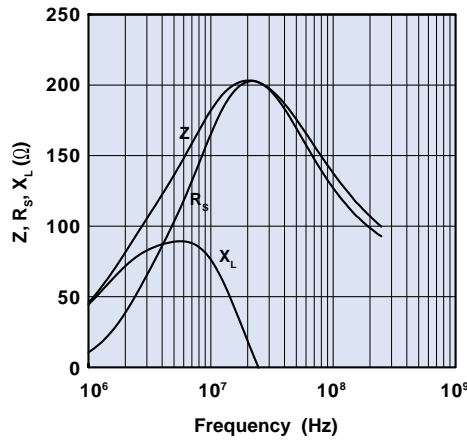
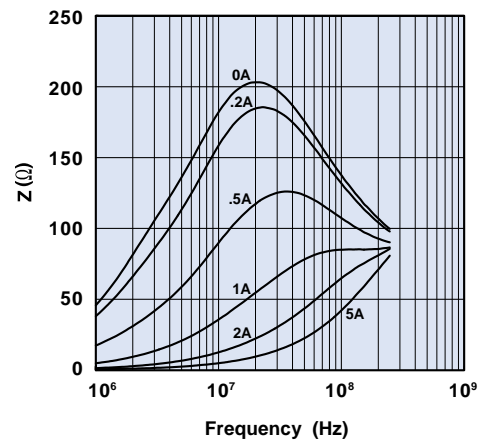


Figure 24B Impedance vs. frequency with dc bias as parameter for bead on lead 2761008112.

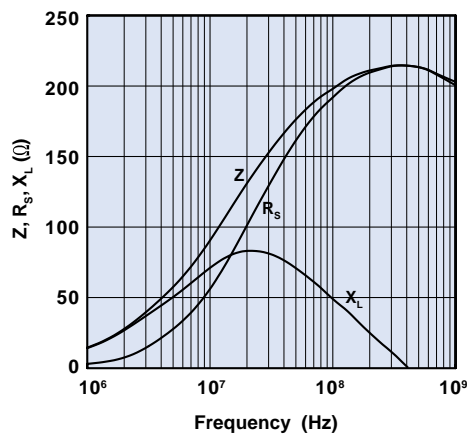
# Beads on Leads



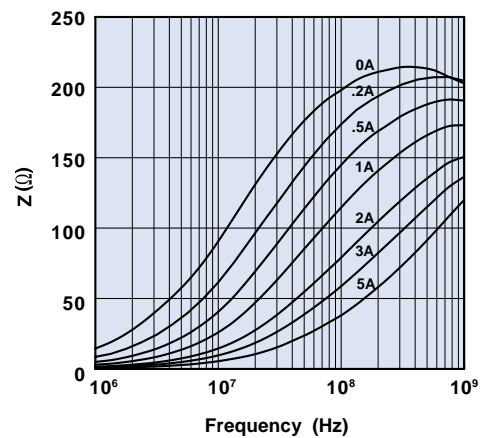
**Figure 25A** Impedance, reactance, and resistance vs. frequency for bead on lead 2773009112.



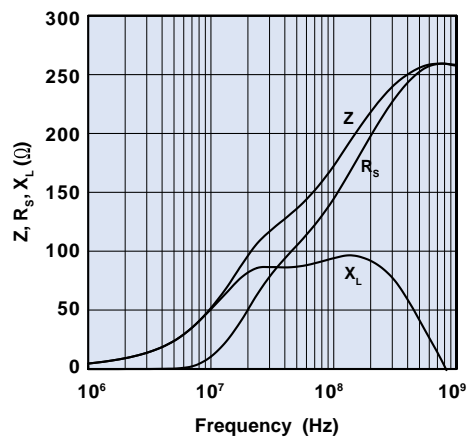
**Figure 25B** Impedance vs. frequency with dc bias as parameter for bead on lead 2773009112.



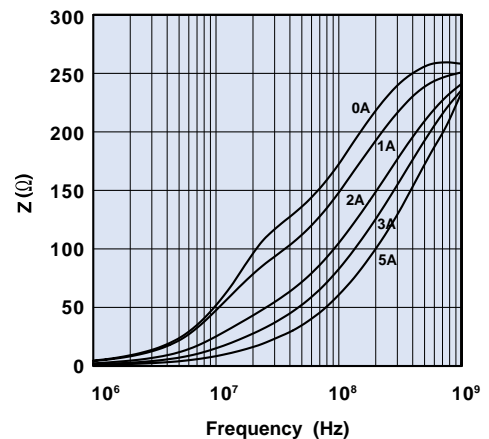
**Figure 26A** Impedance, reactance, and resistance vs. frequency for bead on lead 2743009112.



**Figure 26B** Impedance vs. frequency with dc bias as parameter for bead on lead 2743009112.

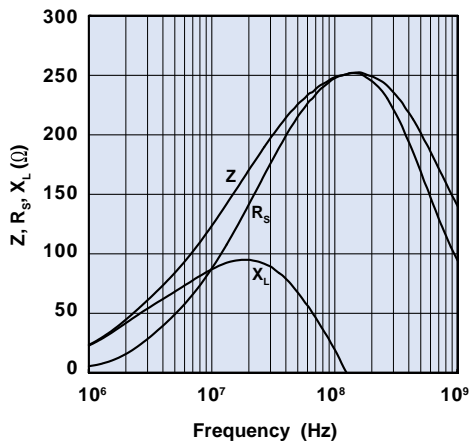


**Figure 27A** Impedance, reactance, and resistance vs. frequency for bead on lead 2761009112.

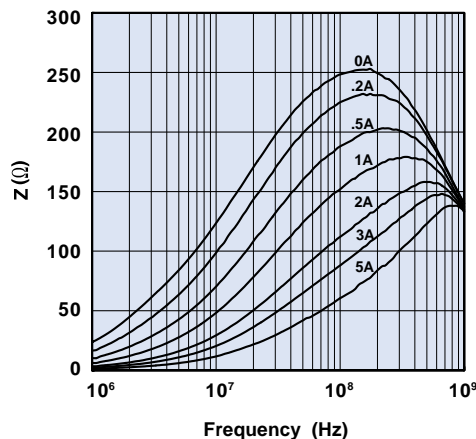


**Figure 27B** Impedance vs. frequency with dc bias as parameter for bead on lead 2761009112.

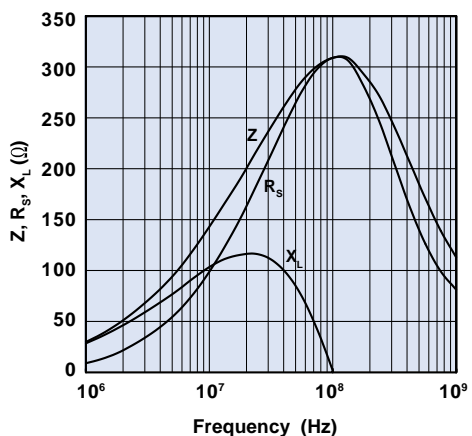
# Beads on Leads



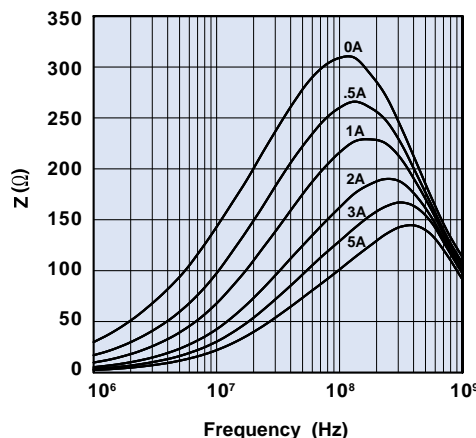
**Figure 28A** Impedance, reactance, and resistance vs. frequency for bead on lead 2743012201.



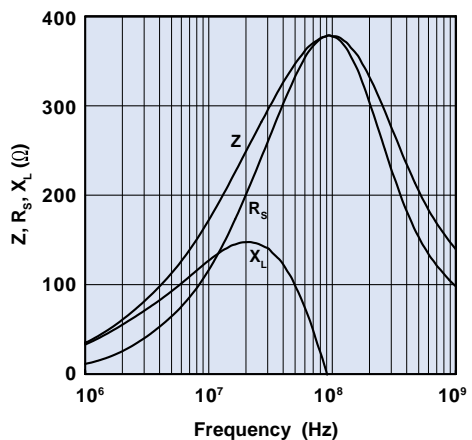
**Figure 28B** Impedance vs. frequency with dc bias as parameter for bead on lead 2743012201.



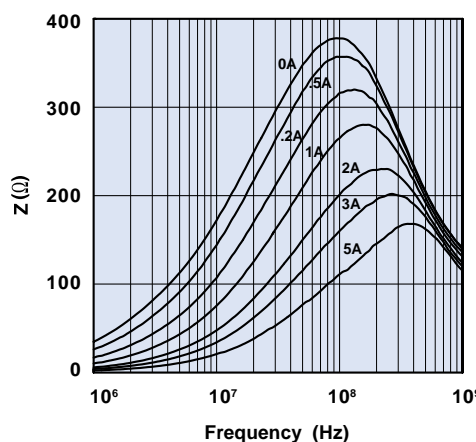
**Figure 29A** Impedance, reactance, and resistance vs. frequency for bead on lead 2743013211.



**Figure 29B** Impedance vs. frequency with dc bias as parameter for bead on lead 2743013211.



**Figure 30A** Impedance, reactance, and resistance vs. frequency for bead on lead 2743014221.



**Figure 30B** Impedance vs. frequency with dc bias as parameter for bead on lead 2743014221.



# SM Beads

Surface mount beads and common-mode surface mount beads are available from Fair-Rite in several sizes. Their rugged construction decreases dc resistance and increases current carrying capacity compared with plated beads.

The Common-Mode surface mount bead provides a common path for the magnetic flux generated by the current to the load and the return current from the load. The current compensation results in zero magnetic flux in the core.

- *12mm taped SM Beads are supplied taped and reeled per EIA Standard 481-1-A and IEC 60286-3. 16mm and 24mm taped SM Beads are supplied taped and reeled per EIA Standard 481-2-A and IEC 60286-3. Taped and reeled parts are supplied on a 13" reel.*
- *Parts can also be supplied not taped and reeled and then are bulk packed. This packing method will change the last digit of the part number to a "6".*
- *The copper conductors have a 300  $\mu$ inch thickness tin/lead coating.*
- *SM Beads meet the solderability specifications when tested in accordance with MIL-STD-202, method 208. After dipping the mounting side of the bead, the solder surface shall be at least 95% covered with a smooth solder coating. The edges of the copper strip are not specified as solderable surfaces.*
- *After preheating the beads to within 100°C of the soldering temperature, the parts meet the resistance to soldering requirements of EIA-186-10E, temperature 260 $\pm$ 5°C and time 10 $\pm$ 1 seconds.*
- *Suggested land patterns are in accordance with the recommendations of "Surface Mount Land Patterns (Configuration and Design Rules) ANSI/IPC-SM-782".*
- *SM Beads are controlled for impedance limits only. They are tested for impedance with a single turn, using a Hewlett Packard HP 4191A RF Impedance Analyzer with spring clip fixture HP 16092A.*
- *Recommended storage and operating temperature is -55°C to 125°C.*
- *For impedance vs. frequency curves and DC bias curves for these parts, see Figures 7-21.*
- *The maximum current rating for these beads is 5 amps.*
- *Common-mode beads can withstand a minimum breakdown voltage of 500VDC.*
- *For any SM bead requirement not listed in the catalog, please contact our customer service group for availability and pricing.*
- *The Surface Mount Bead Kit (part number 0199000025) is available for prototype evaluation. See page 92.*

# SM Beads

Dimensions (Bold numbers are in millimeters, light numbers are nominal in inches.)

Part Number*	Fig.	A	B	C	D	E	Wt (g)	Tape Width mm	Pitch mm	Parts/Reel
<b>2773019447</b>	1	<b>2.85±0.2</b> .112	<b>3.05±0.1</b> .120	<b>5.1 - 0.85</b> .184	<b>1.5±0.5</b> .059	—	.15	12	8	2800
<b>2743019447</b>	1	<b>2.85±0.2</b> .112	<b>3.05±0.1</b> .120	<b>5.1 - 0.85</b> .184	<b>1.5±0.5</b> .059	—	.15	12	8	2800
<b>2761019447</b>	1	<b>2.85±0.2</b> .112	<b>3.05±0.1</b> .120	<b>5.1 - 0.85</b> .184	<b>1.5±0.5</b> .059	—	.15	12	8	2800
<b>2773021447</b>	1	<b>2.85±0.2</b> .112	<b>3.05±0.1</b> .120	<b>9.6 - 0.95</b> .359	<b>1.5±0.5</b> .059	—	.30	16	8	2800
<b>2743021447</b>	1	<b>2.85±0.2</b> .112	<b>3.05±0.1</b> .120	<b>9.6 - 0.95</b> .359	<b>1.5±0.5</b> .059	—	.30	16	8	2800
<b>2761021447</b>	1	<b>2.85±0.2</b> .112	<b>3.05±0.1</b> .120	<b>9.6 - 0.95</b> .359	<b>1.5±0.5</b> .059	—	.30	16	8	2800
<b>2773037447</b>	1	<b>2.70±0.2</b> .106	<b>4.6±0.2</b> .181	<b>9.25 - 0.7</b> .350	<b>1.4±0.4</b> .055	—	.45	16	8	2800
<b>2743037447</b>	1	<b>2.70±0.2</b> .106	<b>4.6±0.2</b> .181	<b>9.25 - 0.7</b> .350	<b>1.4±0.4</b> .055	—	.45	16	8	2800
<b>2773044447</b>	1	<b>1.52 Max.</b> .060 Max.	<b>3.1±0.1</b> .122	<b>5.65±0.45</b> .222	<b>1.55±0.5</b> .061	—	.09	12	8	4500
<b>2744044447</b>	1	<b>1.52 Max.</b> .060 Max.	<b>3.1±0.1</b> .122	<b>5.65±0.45</b> .222	<b>1.55±0.5</b> .061	—	.09	12	8	4500
<b>2744041447</b>	2	<b>2.85±0.2</b> .112	<b>5.6±0.2</b> .220	<b>5.0 - 0.6</b> .185	<b>1.35±0.5</b> .053	<b>2.54±0.1</b> .100	.30	12	8	2400
<b>2744045447</b>	2	<b>2.85±0.2</b> .112	<b>5.6±0.2</b> .220	<b>8.9 - 0.8</b> .335	<b>1.35±0.5</b> .053	<b>2.54±0.1</b> .100	.53	16	8	2400
<b>2744040447</b>	3	<b>1.45±0.2</b> .057	<b>4.5±0.2</b> .177	<b>6.2 - 0.6</b> .232	<b>1.4±0.4</b> .055	<b>1.27±0.05</b> .050	.14	12	8	4000
<b>2744051447</b>	4	<b>4.5 Max.</b> .177 Max.	<b>6.65 Max.</b> .262 Max.	<b>12.0 Max.</b> .472 Max.	<b>2.5±0.5</b> .098	<b>3.00±0.1</b> .120	1.0	24	12	1000
<b>2744555577</b>	5	<b>5.0 Max.</b> .197 Max.	<b>5.00±0.25</b> .197	<b>11.0 Max.</b> .433 Max.	<b>2.0 Min.</b> .079 Min.	—	.96	24	12	1500

\* Bold part numbers designate preferred parts.

# SM Beads

Dimensions (Bold numbers are in millimeters, light numbers are nominal in inches.)

Part Number*	Typical Impedance( $\Omega$ ) <sup>1</sup>				Rdc(m $\Omega$ )	Land Pattern Dimensions					Z, R <sub>s</sub> , X <sub>L</sub> vs. Frequency Curve	DC Bias Curve
	10 MHz	25 MHz	100 MHz	250 MHz		V	W (ref.)	X	Y	Z		
<b>2773019447</b>	31	40	—	—	0.6 Max.	<b>1.0</b> .040	<b>4.0</b> .157	<b>1.8</b> .071	<b>3.0</b> .118	—	Figure 7A	Figure 7B
<b>2743019447</b>	—	29	47	—	0.6 Max.	<b>1.0</b> .040	<b>4.0</b> .157	<b>1.8</b> .071	<b>3.0</b> .118	—	Figure 8A	Figure 8B
<b>2761019447</b>	—	—	38	50	0.6 Max.	<b>1.0</b> .040	<b>4.0</b> .157	<b>1.8</b> .071	<b>3.0</b> .118	—	Figure 9A	Figure 9B
<b>2773021447</b>	60	78	—	—	0.9 Max.	<b>4.5</b> .177	<b>7.5</b> .295	<b>1.8</b> .071	<b>3.0</b> .118	—	Figure 10A	Figure 10B
<b>2743021447</b>	—	56	95	—	0.9 Max.	<b>4.5</b> .177	<b>7.5</b> .295	<b>1.8</b> .071	<b>3.0</b> .118	—	Figure 11A	Figure 11B
<b>2761021447</b>	—	—	75	100	0.9 Max.	<b>4.5</b> .177	<b>7.5</b> .295	<b>1.8</b> .071	<b>3.0</b> .118	—	Figure 12A	Figure 12B
<b>2773037447</b>	60	78	—	—	0.7 Max.	<b>5.0</b> .197	<b>8.0</b> .315	<b>1.8</b> .071	<b>3.0</b> .118	—	Figure 13A	Figure 13B
<b>2743037447</b>	—	56	95	—	0.7 Max.	<b>5.0</b> .197	<b>8.0</b> .315	<b>1.8</b> .071	<b>3.0</b> .118	—	Figure 14A	Figure 14B
<b>2773044447</b>	25	33	—	—	0.8 Max.	<b>1.5</b> .059	<b>4.5</b> .177	<b>1.8</b> .071	<b>3.0</b> .118	—	Figure 15A	Figure 15B
<b>2744044447</b>	—	21	36	—	0.8 Max.	<b>1.5</b> .059	<b>4.5</b> .177	<b>1.8</b> .071	<b>3.0</b> .118	—	Figure 16A	Figure 16B
<b>2744041447</b>	—	20	33	—	0.8 Max.	<b>1.0</b> .040	<b>4.0</b> .157	<b>1.8</b> .071	<b>3.0</b> .118	<b>2.54</b> .100	Figure 17A	Figure 17B
<b>2744045447</b>	—	38	60	—	1.2 Max.	<b>4.0</b> .158	<b>7.0</b> .276	<b>1.8</b> .071	<b>3.0</b> .118	<b>2.54</b> .100	Figure 18A	Figure 18B
<b>2744040447</b>	—	29	56	—	1.4 Max.	<b>1.8</b> .071	<b>4.8</b> .189	<b>0.8</b> .032	<b>3.0</b> .118	<b>1.27</b> .050	Figure 19A	Figure 19B
<b>2744051447</b>	—	100	230	<b>275</b> @300MHz	3.0 Max.	<b>4.0</b> .158	<b>9.0</b> .354	<b>1.0</b> .040	<b>5.0</b> .197	<b>3.0</b> .118	Figure 20A	Figure 20B
<b>2744555577</b>	—	425	600	—	7.5 Max.	<b>2.0</b> .079	<b>7.0</b> .276	<b>2.0</b> .079	<b>5.0</b> .197	—	Figure 21A	Figure 21B

\* Bold part numbers designate preferred parts.

<sup>1</sup> Guaranteed Z Min is Z Typ -20%

# SM Beads

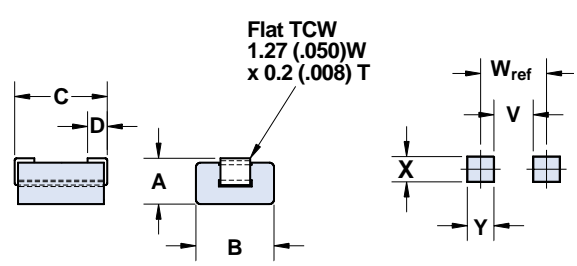


Figure 1

Land Pattern  
for Fig. 1

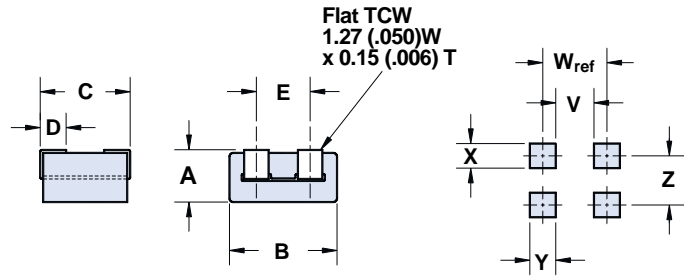


Figure 2  
Common-Mode Bead

Land Pattern  
for Fig. 2  
E = Z

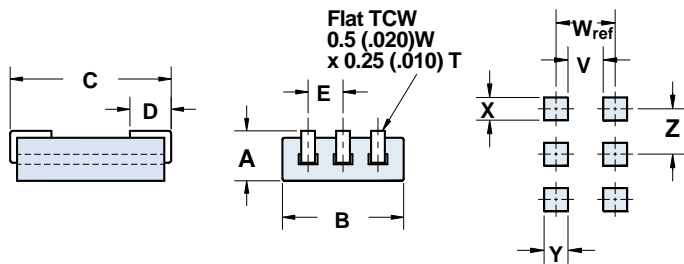


Figure 3

Land Pattern  
for Fig. 3  
E = Z

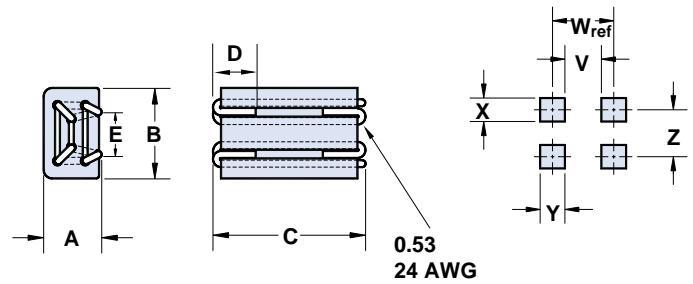


Figure 4  
Common-Mode Bead

Land Pattern  
for Fig. 4  
E = Z

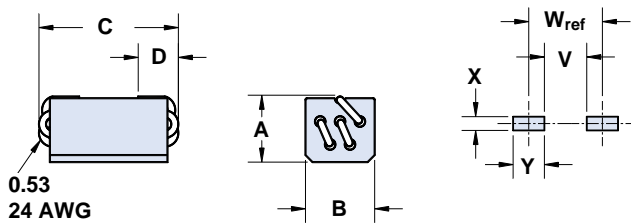
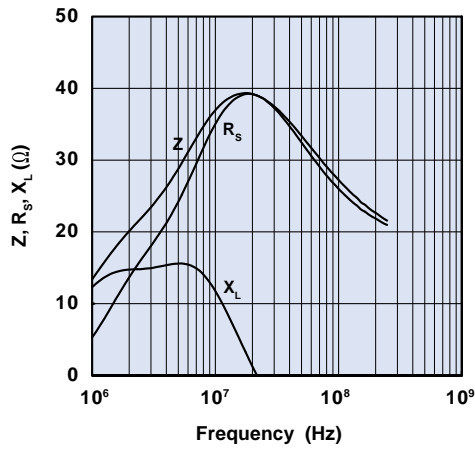


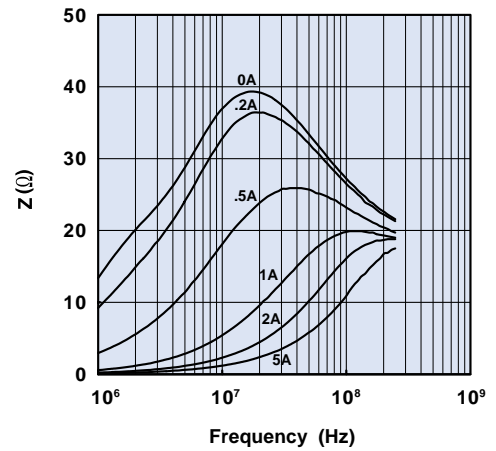
Figure 5

Land Pattern  
for Fig. 5

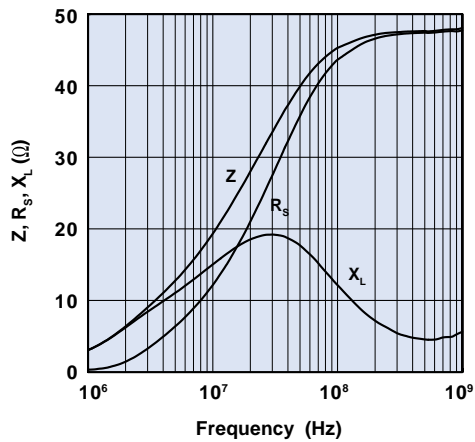
# SM Beads



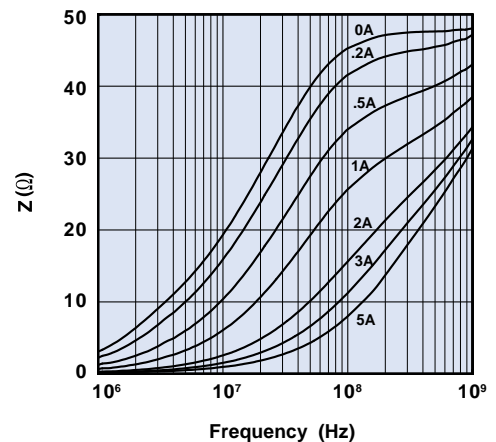
**Figure 7A** Impedance, reactance, and resistance vs. frequency for SM bead 2773019447.



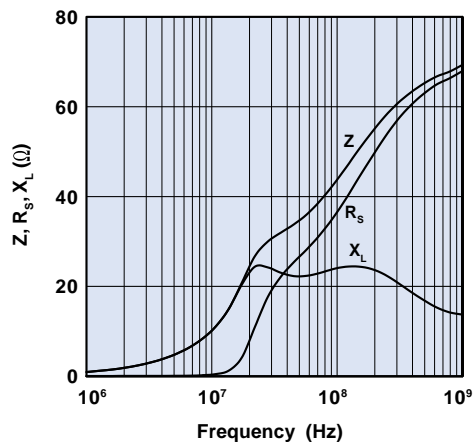
**Figure 7B** Impedance vs. frequency with dc bias as parameter for SM bead 2773019447.



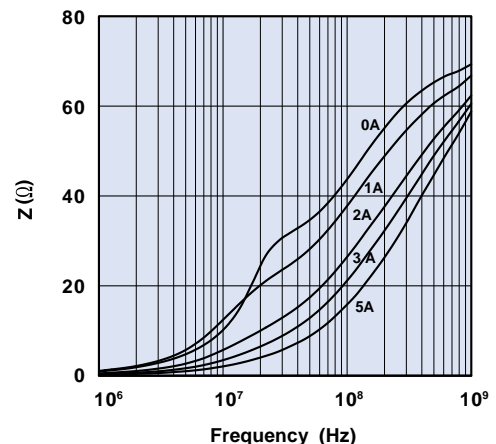
**Figure 8A** Impedance, reactance, and resistance vs. frequency for SM bead 2743019447.



**Figure 8B** Impedance vs. frequency with dc bias as parameter for SM bead 2743019447.

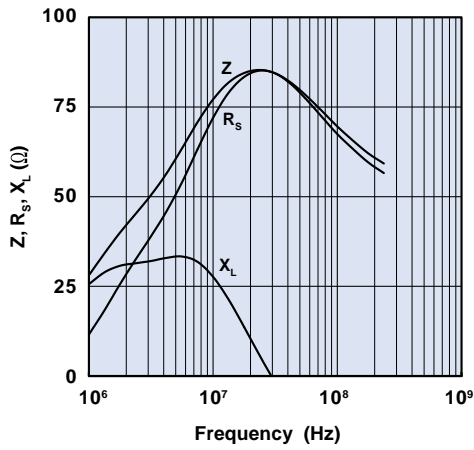


**Figure 9A** Impedance, reactance, and resistance vs. frequency for SM bead 2761019447.

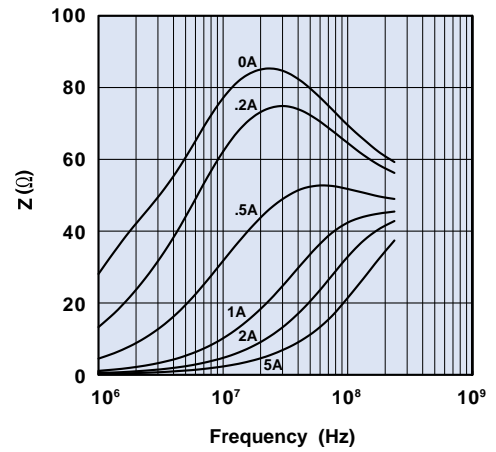


**Figure 9B** Impedance vs. frequency with dc bias as parameter for SM bead 2761019447.

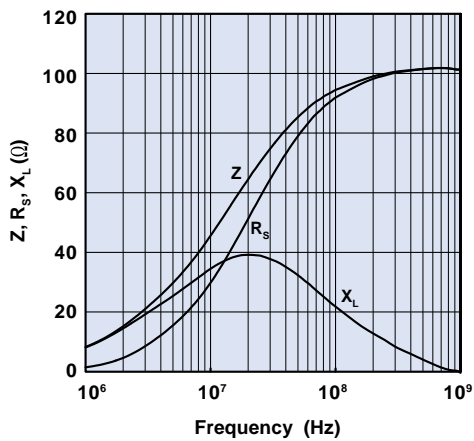
# SM Beads



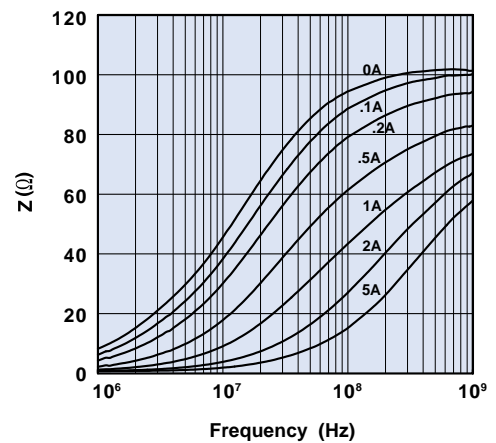
**Figure 10A** Impedance, reactance, and resistance vs. frequency for SM bead 2773021447.



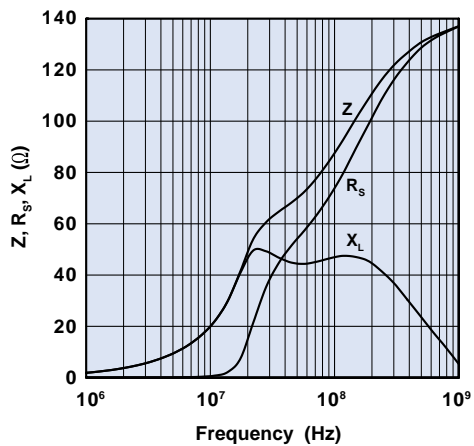
**Figure 10B** Impedance vs. frequency with dc bias as parameter for SM bead 2773021447.



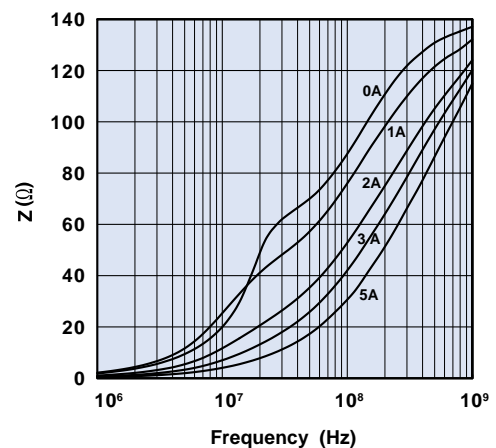
**Figure 11A** Impedance, reactance, and resistance vs. frequency for SM bead 2743021447.



**Figure 11B** Impedance vs. frequency with dc bias as parameter for SM bead 2743021447.

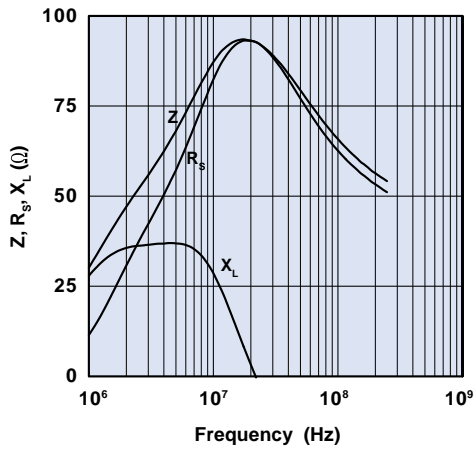


**Figure 12A** Impedance, reactance, and resistance vs. frequency for SM bead 2761021447.

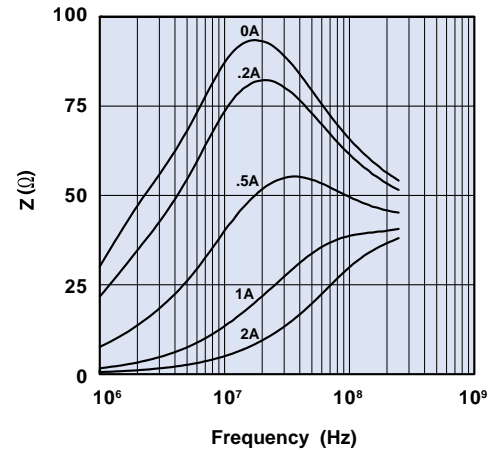


**Figure 12B** Impedance vs. frequency with dc bias as parameter for SM bead 2761021447.

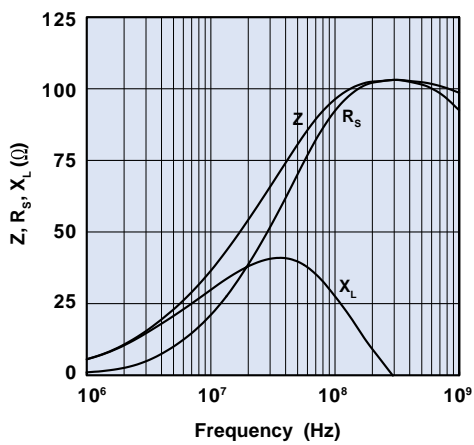
# SM Beads



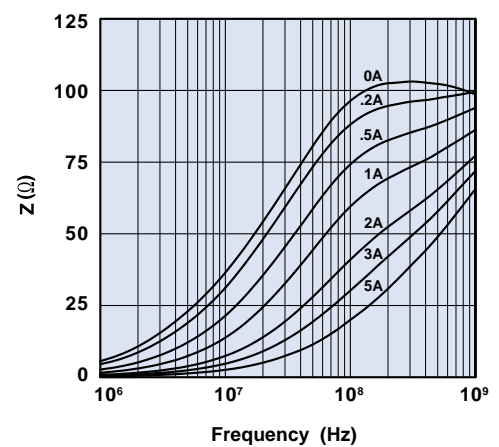
**Figure 13A** Impedance, reactance, and resistance vs. frequency for SM bead 2773037447.



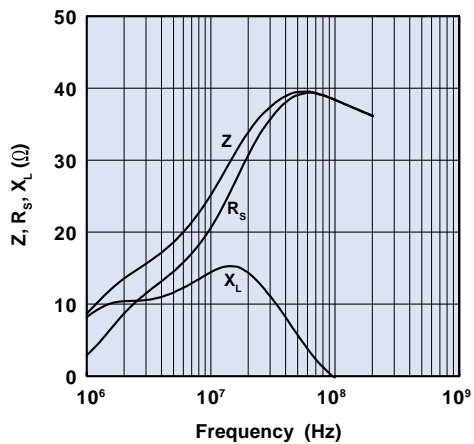
**Figure 13B** Impedance vs. frequency with dc bias as parameter for SM bead 2773037447.



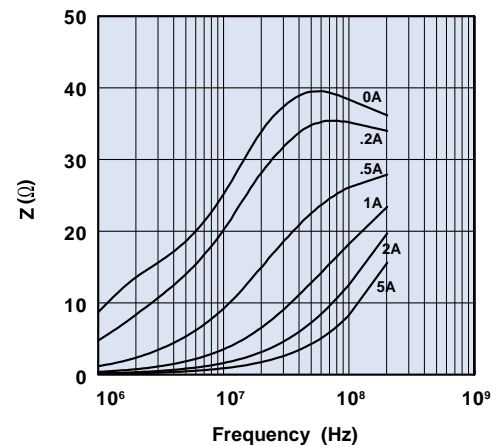
**Figure 14A** Impedance, reactance, and resistance vs. frequency for SM bead 2743037447.



**Figure 14B** Impedance vs. frequency with dc bias as parameter for SM bead 2743037447.

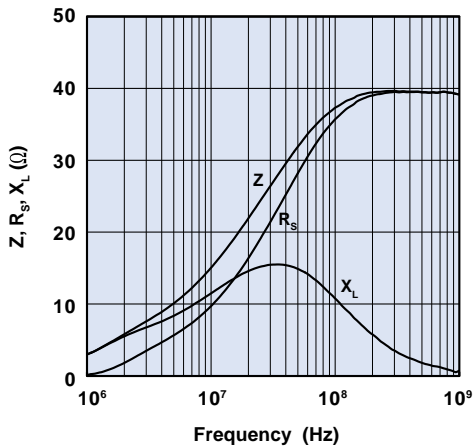


**Figure 15A** Impedance, reactance, and resistance vs. frequency for SM bead 2773044447.

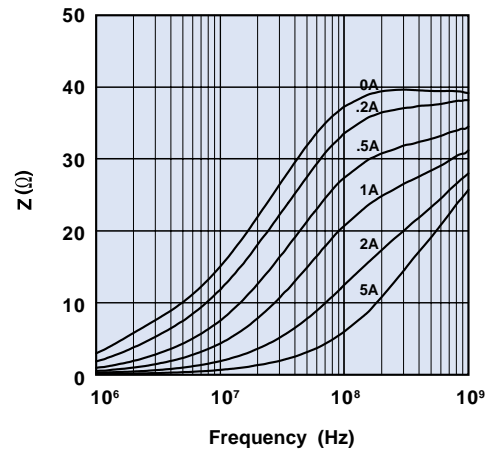


**Figure 15B** Impedance vs. frequency with dc bias as parameter for SM bead 2773044447.

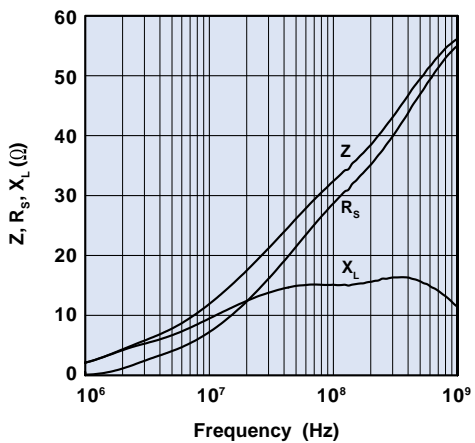
# SM Beads



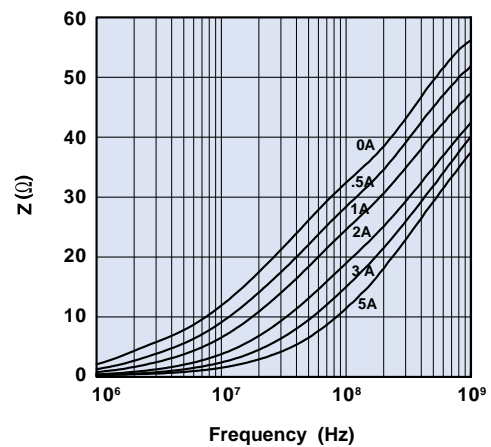
**Figure 16A** Impedance, reactance, and resistance vs. frequency for SM bead 2744044447.



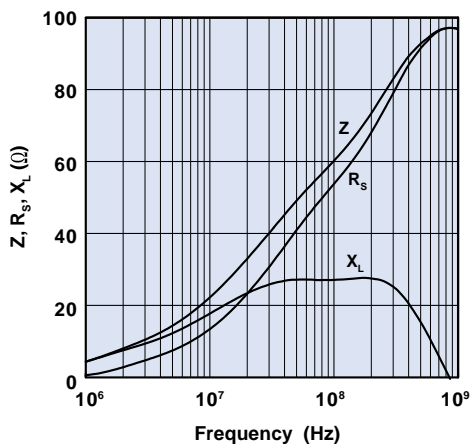
**Figure 16B** Impedance vs. frequency with dc bias as parameter for SM bead 2744044447.



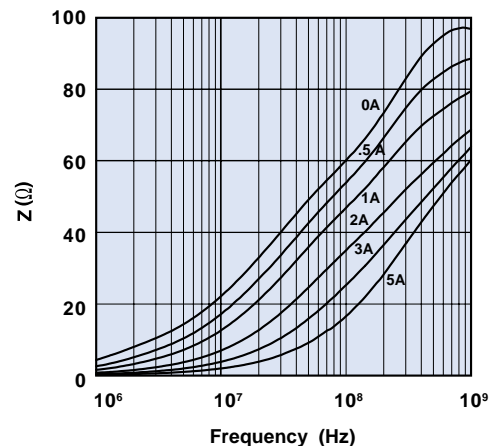
**Figure 17A** Impedance, reactance, and resistance vs. frequency for SM bead 2744041447.



**Figure 17B** Impedance vs. frequency with dc bias as parameter for SM bead 2744041447.



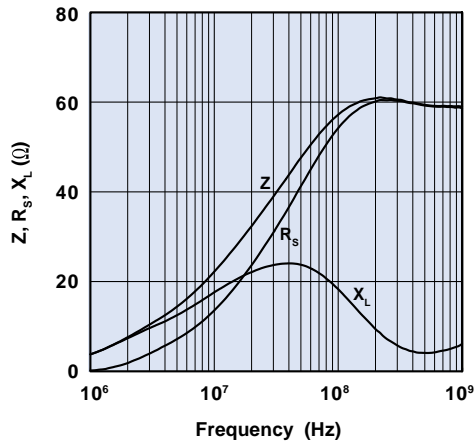
**Figure 18A** Impedance, reactance, and resistance vs. frequency for SM bead 2744045447.



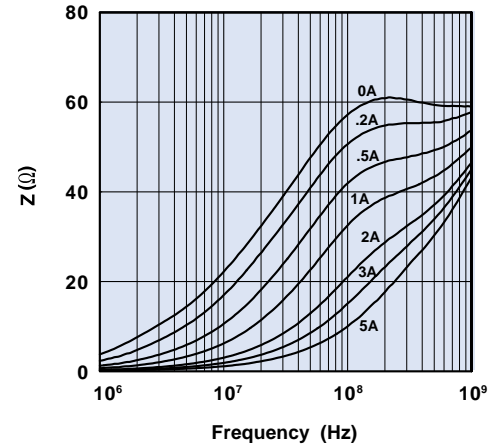
**Figure 18B** Impedance vs. frequency with dc bias as parameter for SM bead 2744045447.



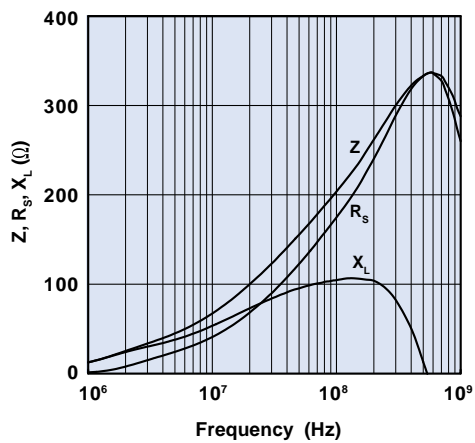
# SM Beads



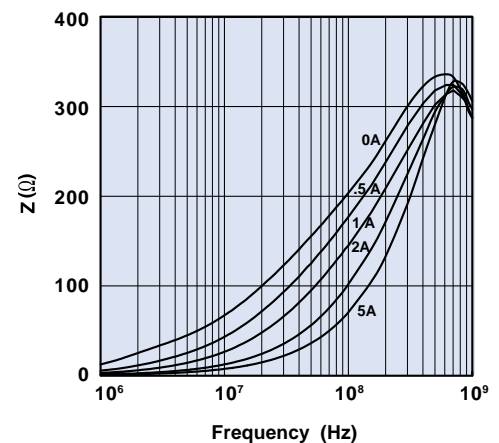
**Figure 19A** Impedance, reactance, and resistance vs. frequency for SM bead 2744040447.



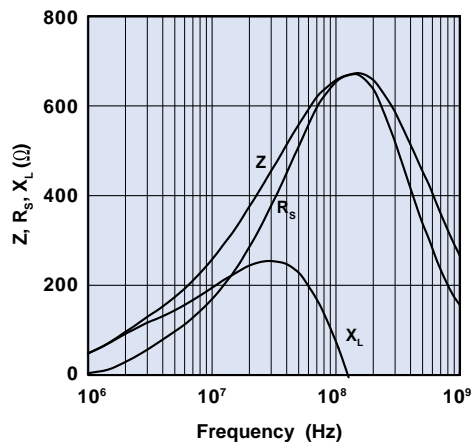
**Figure 19B** Impedance vs. frequency with dc bias as parameter for SM bead 2744040447.



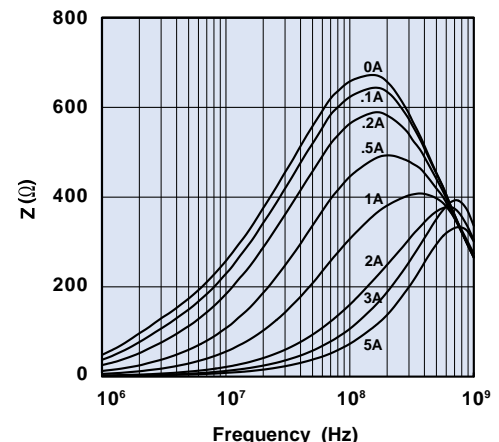
**Figure 20A** Impedance, reactance, and resistance vs. frequency for SM bead 2744051447.



**Figure 20B** Impedance vs. frequency with dc bias as parameter for SM bead 2744051447.



**Figure 21A** Impedance, reactance, and resistance vs. frequency for SM bead 2744555577.



**Figure 21B** Impedance vs. frequency with dc bias as parameter for SM bead 2744555577.

# Chip Beads

Fair-Rite offers a broad selection of chip beads used to suppress EMI in a wide variety of devices such as computers, cellular phones, digital communication equipment, televisions, pagers, and VCRs.

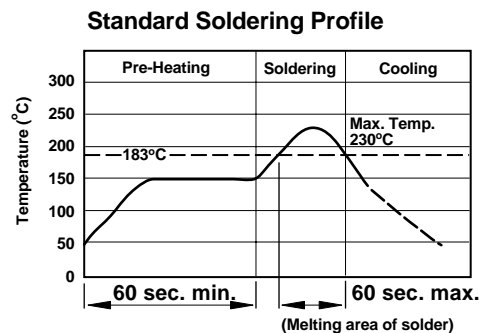
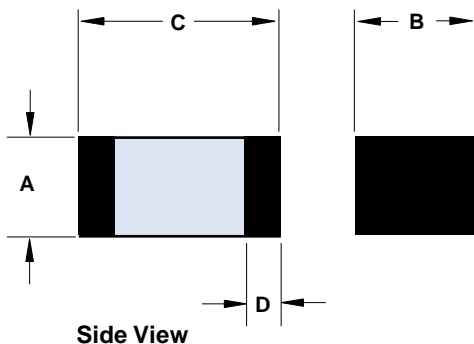
Low current, medium current, and high current chip beads are available. Fair-Rite's chip beads are controlled 100% for impedance and DCR. They are suitable for both wave and reflow solder processes.

Standard and high signal speed parts are available. Standard speed signal chip beads are designed for general noise suppression over a wide frequency range. The high speed signal chip beads offer low impedance at frequencies below 50 MHz and then the impedance increases rapidly to its peak at >100 MHz.

- The 0603 and 0805 beads are supplied 4000 pieces per 7" reel or 10000 pieces per 13" reel. The 1206 beads are supplied 3000 pieces per 7" reel or 10000 pieces per 13" reel. The 1806 beads are supplied 2000 pieces per 7" reel or 10000 pieces per 13" reel. The 1812 beads are supplied 1000 pieces per 7" reel or 5000 pieces per 13" reel.
- The tape width for the 0603, 0805, and 1206 beads is **8mm** with a component pitch of **4mm**. The tape width for the 1806 and 1812 beads is **12mm** with a component pitch of **8mm**.
- The contacts are tin/lead plated. Standard reflow soldering profile is shown below.
- Recommended storage and operating temperature is  $-55^{\circ}\text{C}$  to  $+125^{\circ}\text{C}$ .
- For impedance vs. frequency curves and DC bias curves for these parts, please see Figures 1-61.
- For any chip bead requirement not listed, please contact our customer service group for availability and pricing.
- The Chip Bead Kit (part number 0199000018) is available for prototype evaluation. See page 92.

## Part Number System: Example 2512063017Y1

25	1206	301	7	Y	1
<b>Chip Bead Code</b>	<b>Package Size Code</b>	<b>Impedance Code</b>	<b>Packaging Code</b> 6= Bulk Packed 7= Taped and Reeled 7" Reel 8= Taped and Reeled 13" Reel	<b>Material Code</b> Y = Standard Signal Speed Z= High Signal Speed	<b>Current Code</b> 0 < 1.0A 1 $\geq$ 1.0A < 2.0A 3 $\geq$ 3.0A < 4.0A 6 $\geq$ 6.0A < 7.0A



# Chip Beads

## Low Current Chip Beads (<1 Amp)

Dimensions (Bold numbers are in millimeters, light numbers are in inches.)

Pkg. Size	Dimensions				Wt(g)	Signal Speed	Part Number	Z( $\Omega$ ) $\pm$ 25% @ 100 MHz	Max. DCR ohm	Max. Current mA	Z, R <sub>s</sub> , X <sub>L</sub> vs. Frequency Curve	DC Bias Curve
	A	B	C	D								
0603	0.8 <b><math>\pm</math>0.3</b> .031	0.8 <b><math>\pm</math>0.3</b> .031	1.6 <b><math>\pm</math>0.15</b> .063	0.4 <b><math>\pm</math>0.2</b> .016	0.006	Standard	2506033007Y0	30	0.1	200	Figure 1A	Figure 1B
							2506036007Y0	60	0.2	200	Figure 2A	Figure 2B
							2506038007Y0	80	0.2	150	Figure 3A	Figure 3B
							2506039007Y0	90	0.2	150	Figure 4A	Figure 4B
							2506031017Y0	100	0.2	150	Figure 5A	Figure 5B
							2506031217Y0	120	0.2	150	Figure 6A	Figure 6B
							2506031517Y0	150	0.3	150	Figure 7A	Figure 7B
							2506033017Y0	300	0.6	100	Figure 8A	Figure 8B
							2506036017Y0	600	0.8	100	Figure 9A	Figure 9B
						2506031027Y0	1000	1	100	Figure 10A	Figure 10B	
						High	2506036007Z0	60	0.5	200	Figure 11A	Figure 11B
							2506031217Z0	120	0.5	150	Figure 12A	Figure 12B
							2506033017Z0	300	0.85	100	Figure 13A	Figure 13B
0805	0.9 <b><math>\pm</math>0.2</b> .035	1.25 <b><math>\pm</math>0.2</b> .049	2.0 <b><math>\pm</math>0.2</b> .079	0.45 <b><math>\pm</math>0.35</b> .018	0.01	Standard	2508051107Y0	11	0.1	300	Figure 14A	Figure 14B
							2508053007Y0	30	0.2	300	Figure 15A	Figure 15B
							2508055007Y0	50	0.2	300	Figure 16A	Figure 16B
							2508056007Y0	60	0.2	300	Figure 17A	Figure 17B
							2508059007Y0	90	0.3	300	Figure 18A	Figure 18B
							2508051017Y0	100	0.3	300	Figure 19A	Figure 19B
							2508051217Y0	120	0.3	300	Figure 20A	Figure 20B
							2508051817Y0	180	0.3	300	Figure 21A	Figure 21B
							2508053017Y0	300	0.4	300	Figure 22A	Figure 22B
							2508056017Y0	600	0.6	200	Figure 23A	Figure 23B
							2508051027Y0	1000	0.8	100	Figure 24A	Figure 24B
						2508051527Y0	1500	1	100	Figure 25A	Figure 25B	
						High	2508056007Z0	60	0.3	300	Figure 26A	Figure 26B
							2508051217Z0	120	0.3	300	Figure 27A	Figure 27B
2508053017Z0	300	0.55	100	Figure 28A	Figure 28B							
1206	1.1 <b><math>\pm</math>0.2</b> .043	1.6 <b><math>\pm</math>0.2</b> .063	3.2 <b><math>\pm</math>0.2</b> .126	0.55 <b><math>\pm</math>0.45</b> .022	0.03	Standard	2512063007Y0	30	0.1	500	Figure 29A	Figure 29B
							2512065007Y0	50	0.2	400	Figure 30A	Figure 30B
							2512066007Y0	60	0.2	400	Figure 31A	Figure 31B
							2512067007Y0	70	0.2	400	Figure 32A	Figure 32B
							2512068007Y0	80	0.2	400	Figure 33A	Figure 33B
							2512069007Y0	90	0.2	300	Figure 34A	Figure 34B
							2512061017Y0	100	0.2	300	Figure 35A	Figure 35B
							2512061217Y0	120	0.2	300	Figure 36A	Figure 36B
							2512063017Y0	300	0.3	200	Figure 37A	Figure 37B
							2512066017Y0	600	0.6	200	Figure 38A	Figure 38B
							2512061027Y0	1000	0.8	100	Figure 39A	Figure 39B
							2512061527Y0	1500@50 MHz	1	100	Figure 40A	Figure 40B
1806	1.6 <b><math>\pm</math>0.2</b> .063	1.6 <b><math>\pm</math>0.2</b> .063	4.5 <b><math>\pm</math>0.2</b> .177	0.55 <b><math>\pm</math>0.45</b> .022	0.06	Standard	2518066007Y0	60	0.2	500	Figure 41A	Figure 41B
							2518067007Y0	70	0.2	500	Figure 42A	Figure 42B
							2518068007Y0	80	0.2	500	Figure 43A	Figure 43B
							2518061017Y0	100	0.3	400	Figure 44A	Figure 44B
							2518061517Y0	150	0.3	400	Figure 45A	Figure 45B
							2518063017Y0	300	0.3	400	Figure 46A	Figure 46B

\* Bold part numbers designate preferred parts.

# Chip Beads

## Medium Current Chip Beads (1-3 Amp)

Dimensions (Bold numbers are in millimeters, light numbers are in inches.)

Pkg. Size	Dimensions				Wt(g)	Signal Speed	Part Number*	Z( $\Omega$ ) $\pm$ 25% @ 100 MHz	Max. DCR ohm	Max. Current mA	Z, R <sub>s</sub> , X <sub>L</sub> vs. Frequency Curve	DC Bias Curve
	A	B	C	D								
<b>0603</b>	<b>0.8<math>\pm</math>0.3</b> .031	<b>0.8<math>\pm</math>0.3</b> .031	<b>1.6<math>\pm</math>0.15</b> .063	<b>0.4<math>\pm</math>0.2</b> .016	<b>0.006</b>	Standard	<b>2506033007Y1</b>	30	0.1	1000	Figure 47A	Figure 47B
<b>0805</b>	<b>0.9<math>\pm</math>0.2</b> .035	<b>1.25<math>\pm</math>0.2</b> .049	<b>2.0<math>\pm</math>0.2</b> .079	<b>0.55<math>\pm</math>0.45</b> .022	<b>0.01</b>	Standard	<b>2508053007Y3</b>	30	0.04	3000	Figure 48A	Figure 48B
<b>1206</b>	<b>1.1<math>\pm</math>0.2</b> .043	<b>1.6<math>\pm</math>0.2</b> .063	<b>3.2<math>\pm</math>0.2</b> .126	<b>0.55<math>\pm</math>0.45</b> .022	<b>0.03</b>	Standard	<b>2512061907Y1</b>	19	0.04	1500	Figure 49A	Figure 49B
							<b>2512063007Y3</b>	30	0.04	3000	Figure 50A	Figure 50B
							<b>2512065007Y3</b>	50	0.05	3000	Figure 51A	Figure 51B
							<b>2512067007Y3</b>	70	0.05	3000	Figure 52A	Figure 52B
<b>1806</b>	<b>1.6<math>\pm</math>0.2</b> .063	<b>1.6<math>\pm</math>0.2</b> .063	<b>4.5<math>\pm</math>0.2</b> .177	<b>0.55<math>\pm</math>0.45</b> .022	<b>0.06</b>	Standard	<b>2518066007Y3</b>	60	0.04	3000	Figure 54A	Figure 54B
							<b>2518068007Y1</b>	80	0.1	1500	Figure 55A	Figure 55B
<b>1812</b>	<b>1.6<math>\pm</math>0.2</b> .063	<b>3.2<math>\pm</math>0.2</b> .126	<b>4.5<math>\pm</math>0.2</b> .177	<b>0.55<math>\pm</math>0.45</b> .022	<b>0.09</b>	Standard	<b>2518127007Y3</b>	70	0.04	3000	Figure 56A	Figure 56B
							<b>2518121217Y3</b>	120	0.04	3000	Figure 57A	Figure 57B

## High Current Chip Beads (>3 Amp)

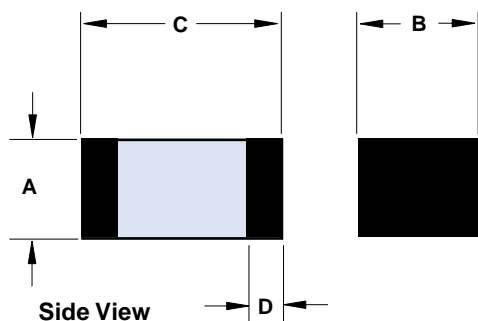
Dimensions (Bold numbers are in millimeters, light numbers are in inches.)

Pkg. Size	Dimensions				Wt(g)	Signal Speed	Part Number*	Z( $\Omega$ ) $\pm$ 25% @ 100 MHz	Max. DCR ohm	Max. Current mA	Z, R <sub>s</sub> , X <sub>L</sub> vs. Frequency Curve	DC Bias Curve
	A	B	C	D								
<b>1206</b>	<b>1.1<math>\pm</math>0.2</b> .043	<b>1.6<math>\pm</math>0.2</b> .063	<b>3.2<math>\pm</math>0.2</b> .126	<b>0.6<math>\pm</math>0.2</b> .024	<b>0.03</b>	Standard	<b>2512065007Y6</b>	50	0.02	6000	Figure 58A	Figure 58B
<b>1806</b>	<b>1.6<math>\pm</math>0.2</b> .063	<b>1.6<math>\pm</math>0.2</b> .063	<b>4.5<math>\pm</math>0.2</b> .177	<b>0.6<math>\pm</math>0.2</b> .024	<b>0.06</b>	Standard	<b>2518065007Y6</b>	50	0.01	6000	Figure 59A	Figure 59B
							<b>2518068007Y6</b>	80	0.02	6000	Figure 60A	Figure 60B
<b>1812</b>	<b>1.6<math>\pm</math>0.2</b> .063	<b>3.2<math>\pm</math>0.2</b> .126	<b>4.5<math>\pm</math>0.2</b> .177	<b>0.55<math>\pm</math>0.45</b> .022	<b>0.09</b>	Standard	<b>2518121217Y6</b>	120	0.02	6000	Figure 61A	Figure 61B

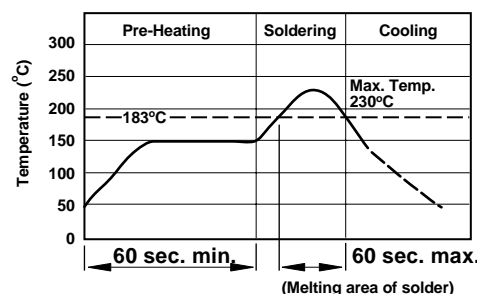
\* Bold part numbers designate preferred parts.

## Part Number System: Example 2512063017Y1

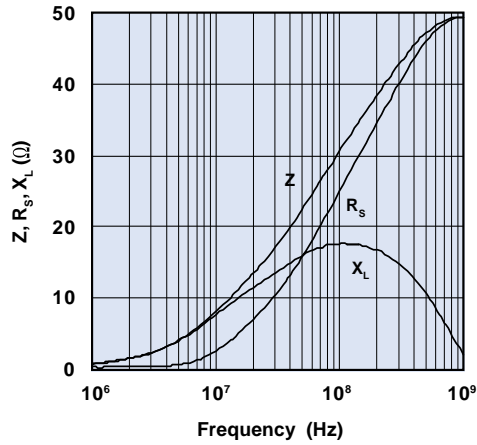
25	1206	301	7	Y	1
Chip Bead Code	Package Size Code	Impedance Code	Packaging Code	Material Code	Current Code
			6= Bulk Packed 7= Taped and Reeled 7" Reel 8= Taped and Reeled 13" Reel	Y = Standard Signal Speed Z = High Signal Speed	0 < 1.0A 1 $\geq$ 1.0A < 2.0A 3 $\geq$ 3.0A < 4.0A 6 $\geq$ 6.0A < 7.0A



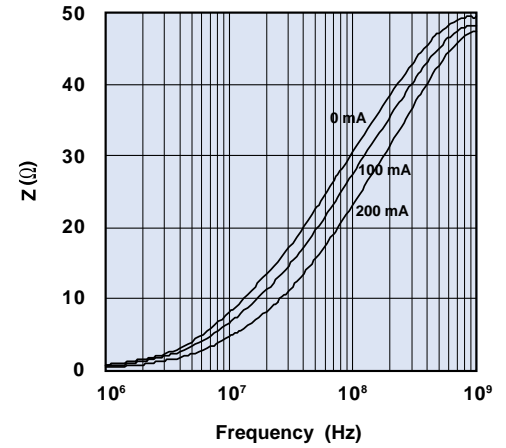
## Standard Soldering Profile



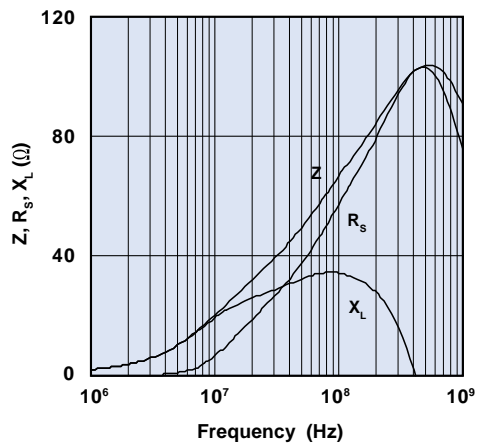
# Chip Beads



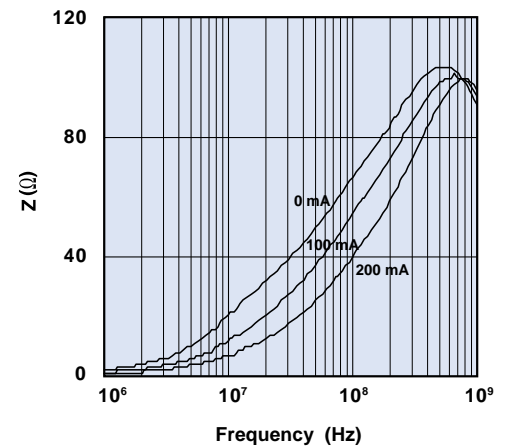
**Figure 1A** Impedance, reactance, and resistance vs. frequency for chip bead 2506033007Y0.



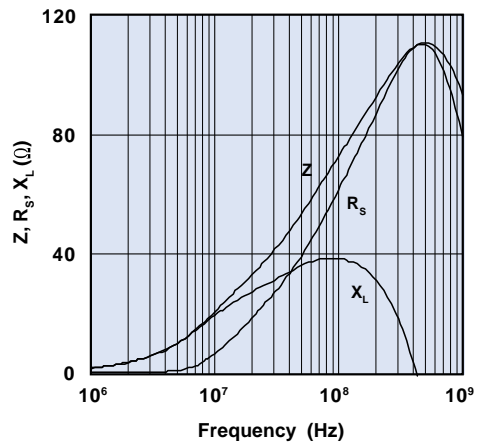
**Figure 1B** Impedance vs. frequency with dc bias as parameter for chip bead 2506033007Y0.



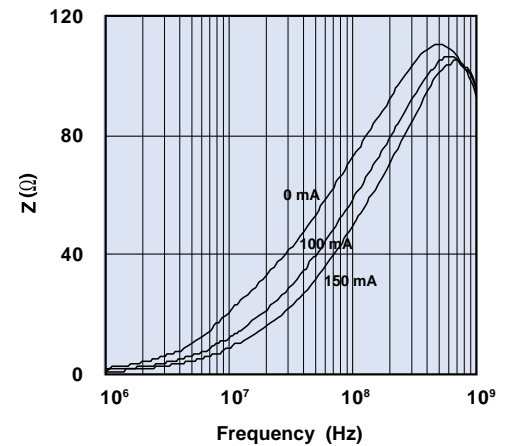
**Figure 2A** Impedance, reactance, and resistance vs. frequency for chip bead 2506036007Y0.



**Figure 2B** Impedance vs. frequency with dc bias as parameter for chip bead 2506036007Y0.

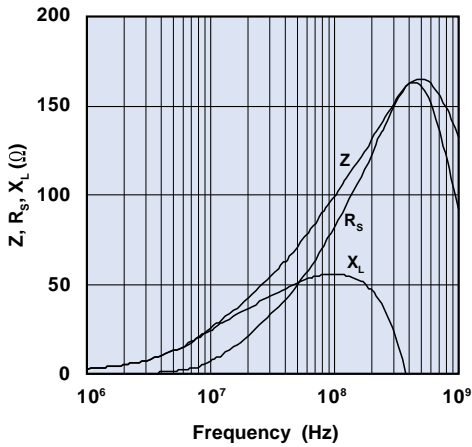


**Figure 3A** Impedance, reactance, and resistance vs. frequency for chip bead 2506038007Y0.

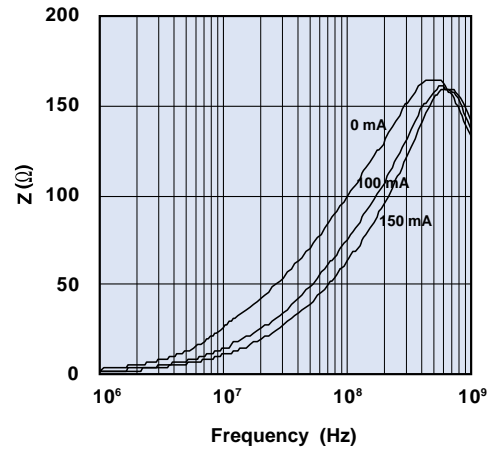


**Figure 3B** Impedance vs. frequency with dc bias as parameter for chip bead 2506038007Y0.

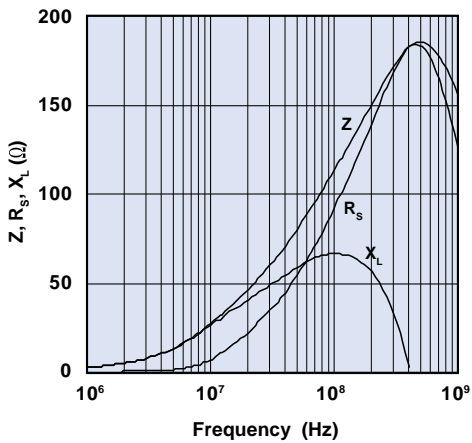
# Chip Beads



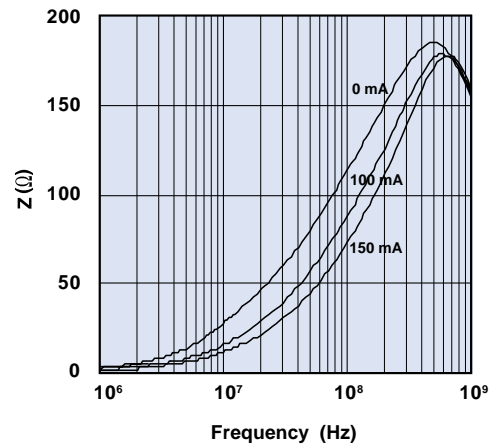
**Figure 4A** Impedance, reactance, and resistance vs. frequency for chip bead 2506039007Y0.



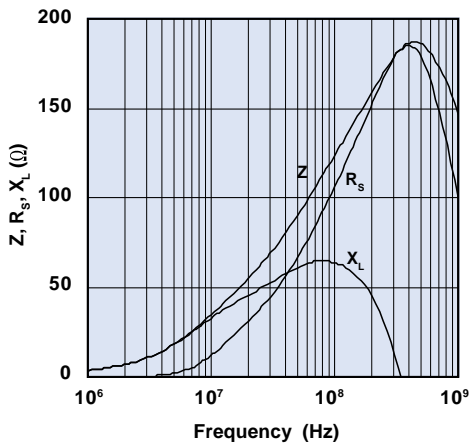
**Figure 4B** Impedance vs. frequency with dc bias as parameter for chip bead 2506039007Y0.



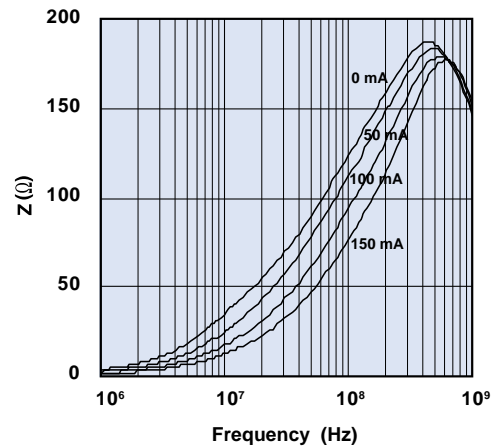
**Figure 5A** Impedance, reactance, and resistance vs. frequency for chip bead 2506031017Y0.



**Figure 5B** Impedance vs. frequency with dc bias as parameter for chip bead 2506031017Y0.

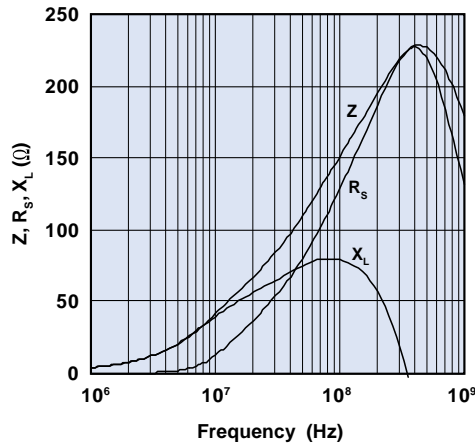


**Figure 6A** Impedance, reactance, and resistance vs. frequency for chip bead 2506031217Y0.

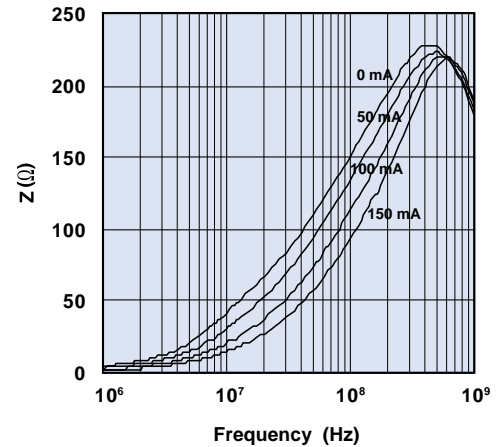


**Figure 6B** Impedance vs. frequency with dc bias as parameter for chip bead 2506031217Y0.

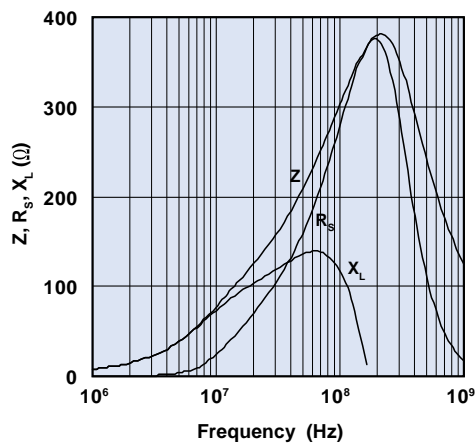
# Chip Beads



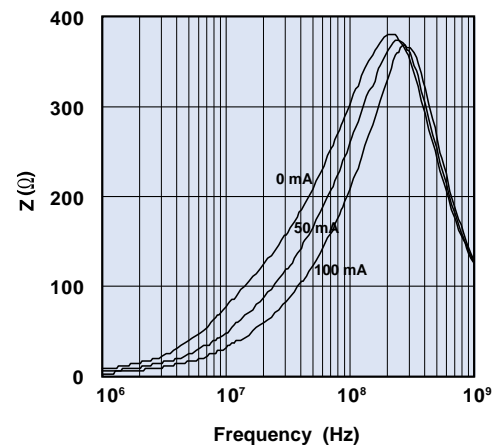
**Figure 7A** Impedance, reactance, and resistance vs. frequency for chip bead 2506031517Y0.



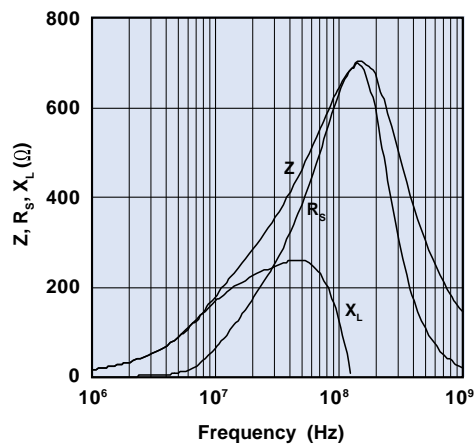
**Figure 7B** Impedance vs. frequency with dc bias as parameter for chip bead 2506031517Y0.



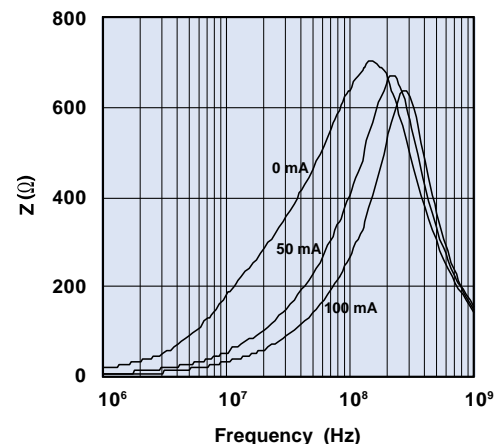
**Figure 8A** Impedance, reactance, and resistance vs. frequency for chip bead 2506033017Y0.



**Figure 8B** Impedance vs. frequency with dc bias as parameter for chip bead 2506033017Y0.

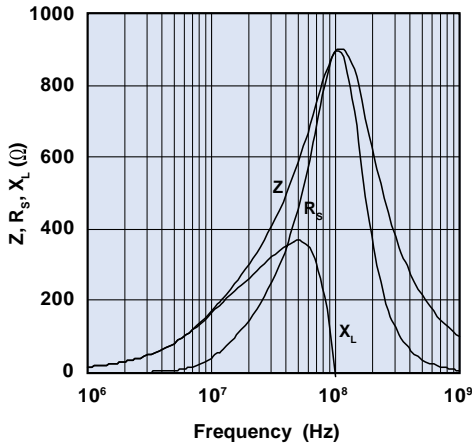


**Figure 9A** Impedance, reactance, and resistance vs. frequency for chip bead 2506036017Y0.

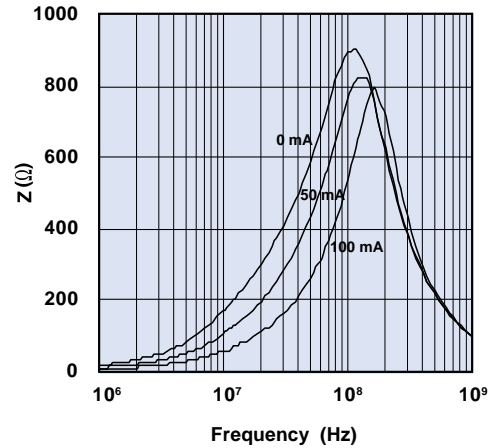


**Figure 9B** Impedance vs. frequency with dc bias as parameter for chip bead 2506036017Y0.

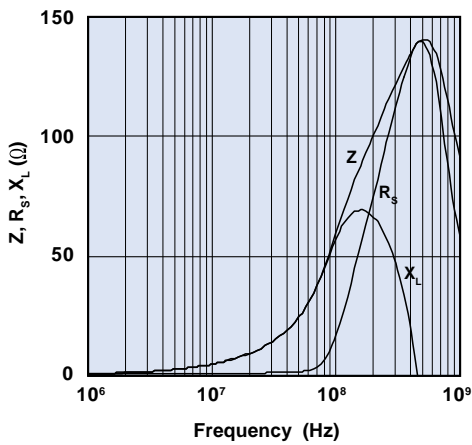
# Chip Beads



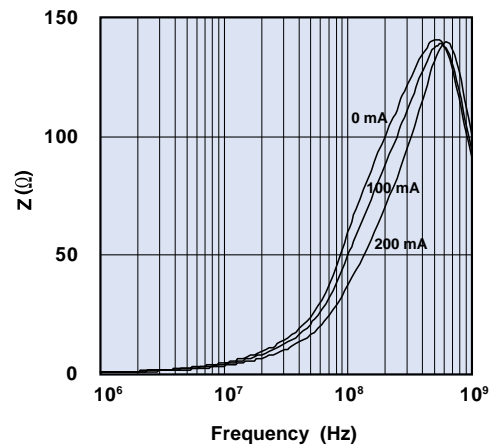
**Figure 10A** Impedance, reactance, and resistance vs. frequency for chip bead 2506031027Y0.



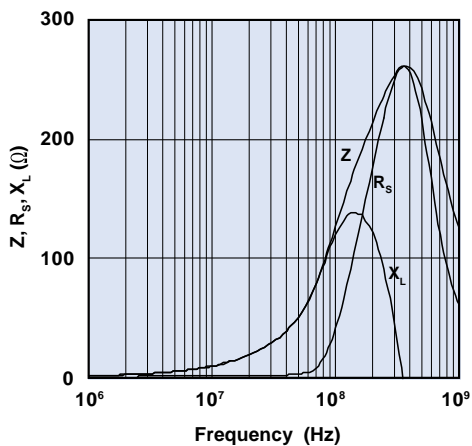
**Figure 10B** Impedance vs. frequency with dc bias as parameter for chip bead 2506031027Y0.



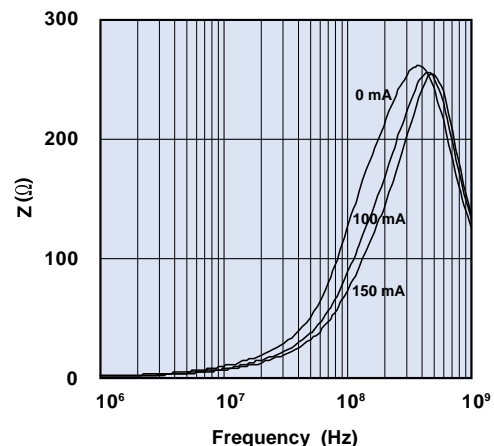
**Figure 11A** Impedance, reactance, and resistance vs. frequency for chip bead 2506036007Z0.



**Figure 11B** Impedance vs. frequency with dc bias as parameter for chip bead 2506036007Z0.



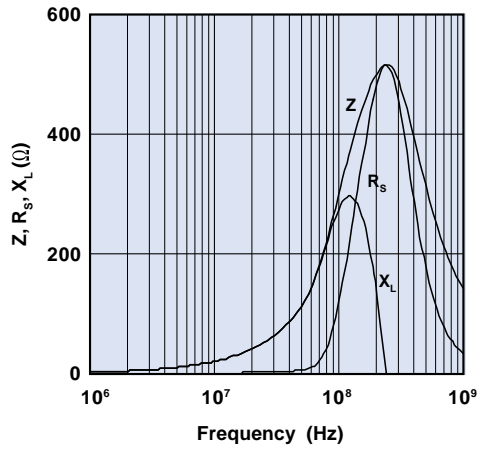
**Figure 12A** Impedance, reactance, and resistance vs. frequency for chip bead 2506031217Z0.



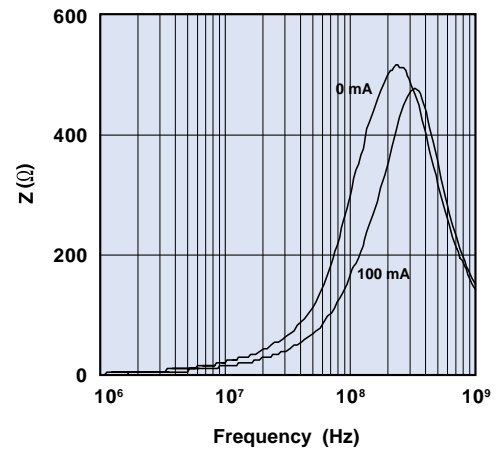
**Figure 12B** Impedance vs. frequency with dc bias as parameter for chip bead 2506031217Z0.



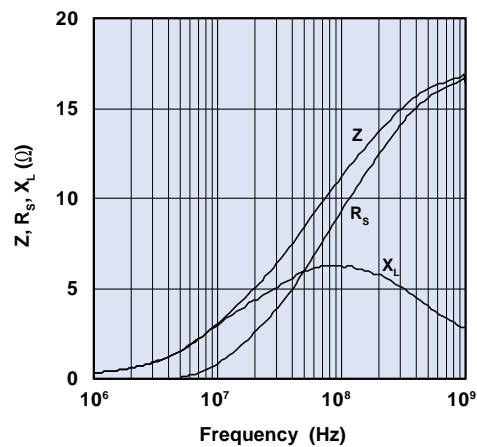
# Chip Beads



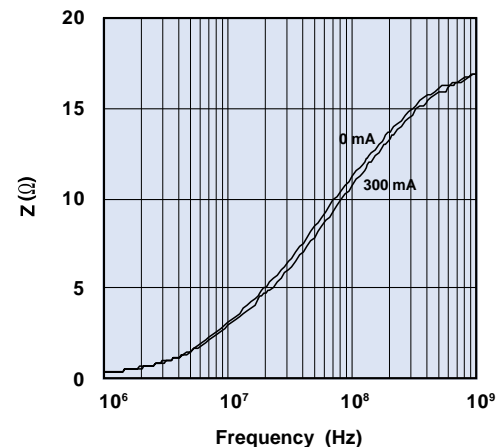
**Figure 13A** Impedance, reactance, and resistance vs. frequency for chip bead 2506033017Z0.



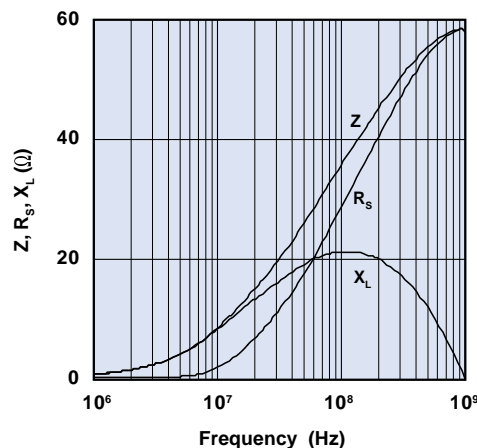
**Figure 13B** Impedance vs. frequency with dc bias as parameter for chip bead 2506033017Z0.



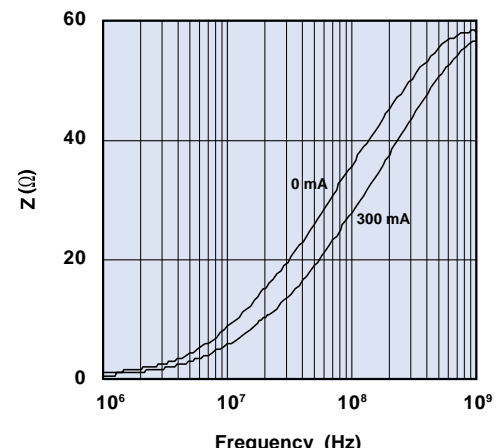
**Figure 14A** Impedance, reactance, and resistance vs. frequency for chip bead 2508051107Y0.



**Figure 14B** Impedance vs. frequency with dc bias as parameter for chip bead 2508051107Y0.

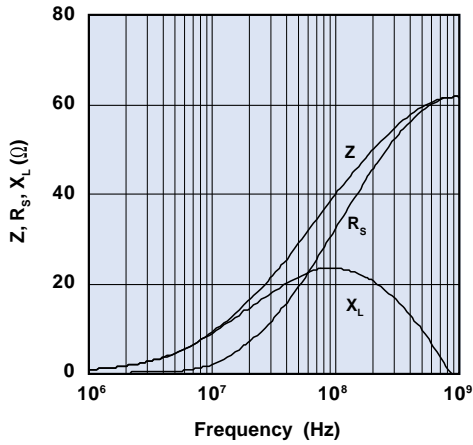


**Figure 15A** Impedance, reactance, and resistance vs. frequency for chip bead 2508053007Y0.

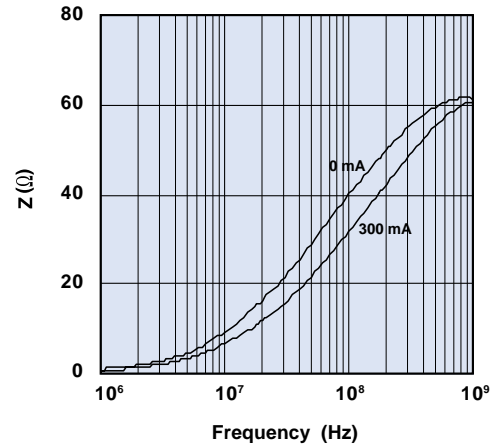


**Figure 15B** Impedance vs. frequency with dc bias as parameter for chip bead 2508053007Y0.

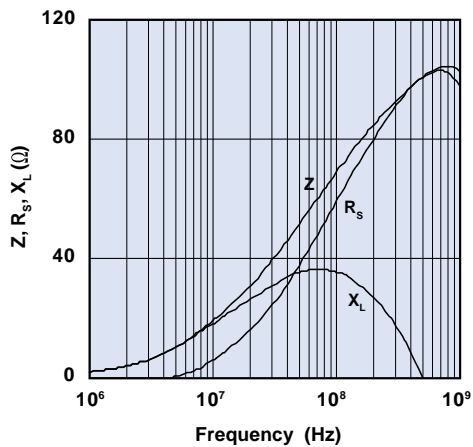
# Chip Beads



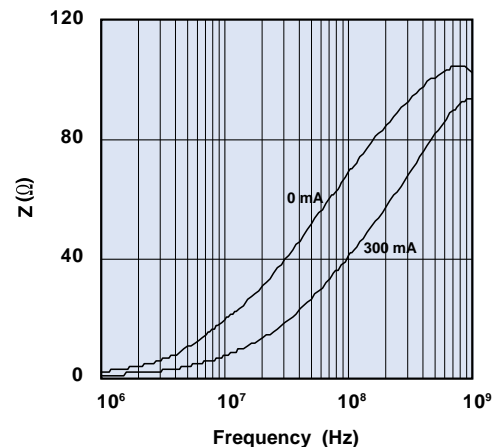
**Figure 16A** Impedance, reactance, and resistance vs. frequency for chip bead 2508055007Y0.



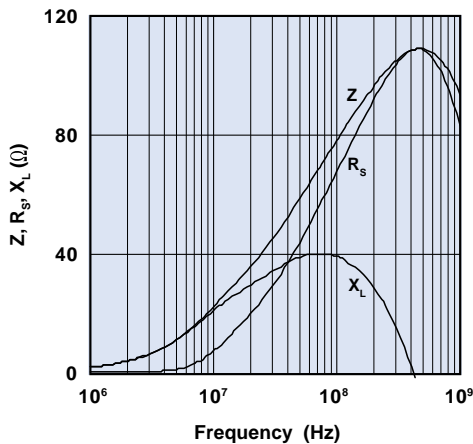
**Figure 16B** Impedance vs. frequency with dc bias as parameter for chip bead 2508055007Y0.



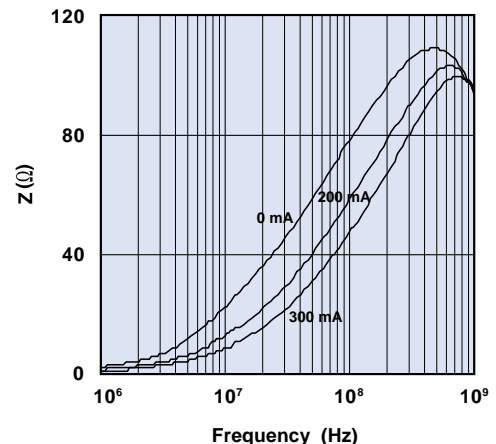
**Figure 17A** Impedance, reactance, and resistance vs. frequency for chip bead 2508056007Y0.



**Figure 17B** Impedance vs. frequency with dc bias as parameter for chip bead 2508056007Y0.

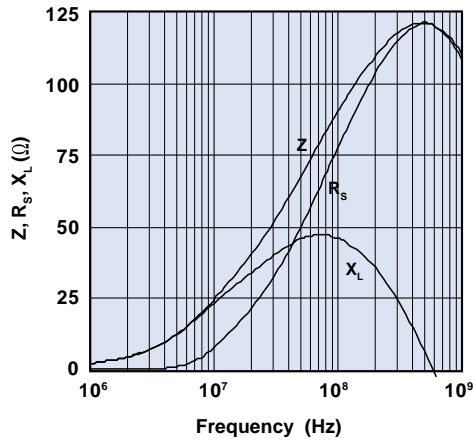


**Figure 18A** Impedance, reactance, and resistance vs. frequency for chip bead 2508059007Y0.

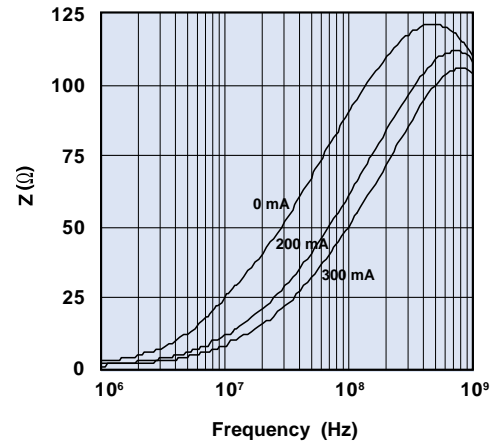


**Figure 18B** Impedance vs. frequency with dc bias as parameter for chip bead 2508059007Y0.

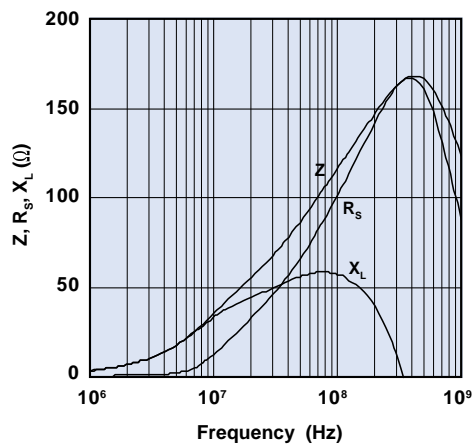
# Chip Beads



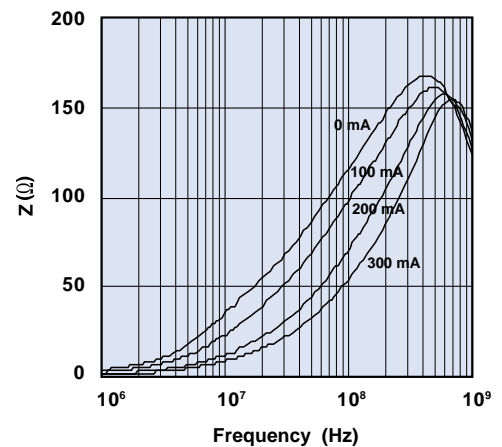
**Figure 19A** Impedance, reactance, and resistance vs. frequency for chip bead 2508051017Y0.



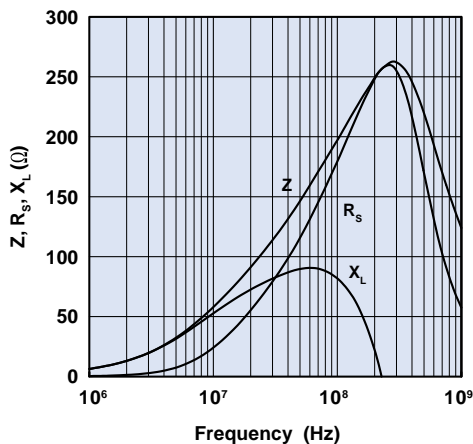
**Figure 19B** Impedance vs. frequency with dc bias as parameter for chip bead 2508051017Y0.



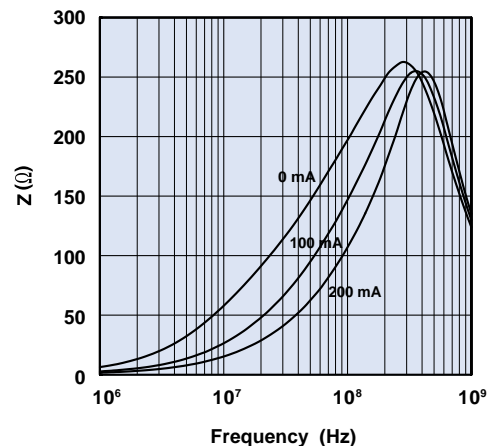
**Figure 20A** Impedance, reactance, and resistance vs. frequency for chip bead 2508051217Y0.



**Figure 20B** Impedance vs. frequency with dc bias as parameter for chip bead 2508051217Y0.

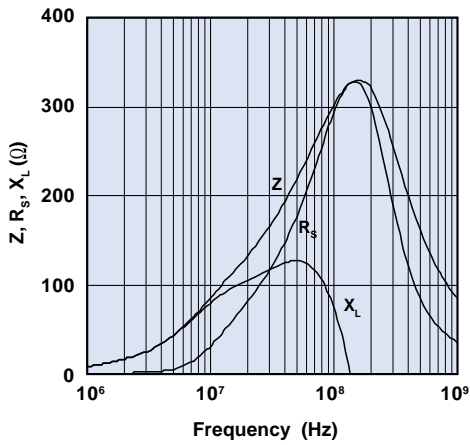


**Figure 21A** Impedance, reactance, and resistance vs. frequency for chip bead 2508051817Y0.

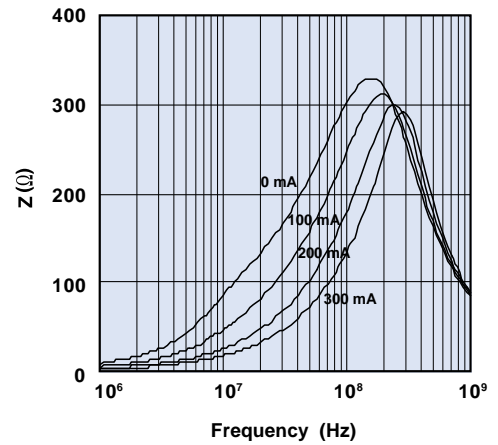


**Figure 21B** Impedance vs. frequency with dc bias as parameter for chip bead 2508051817Y0.

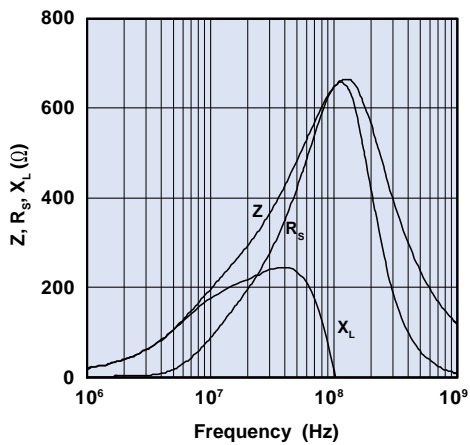
# Chip Beads



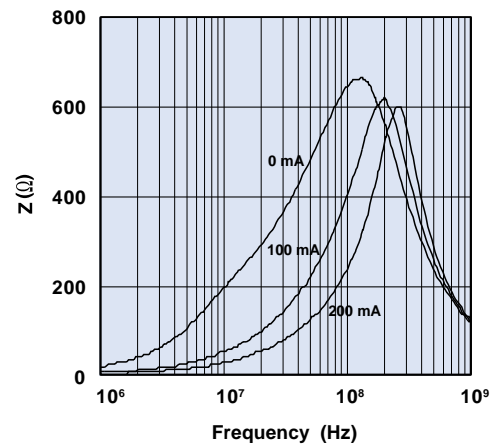
**Figure 22A** Impedance, reactance, and resistance vs. frequency for chip bead 2508053017Y0.



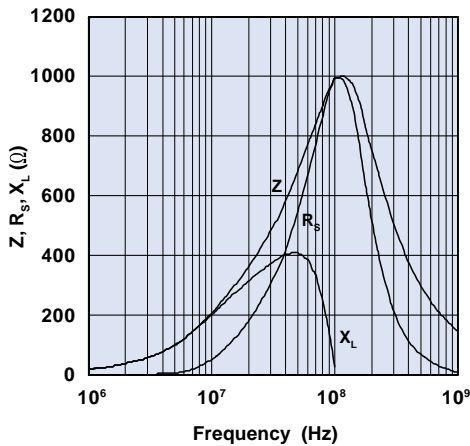
**Figure 22B** Impedance vs. frequency with dc bias as parameter for chip bead 2508053017Y0.



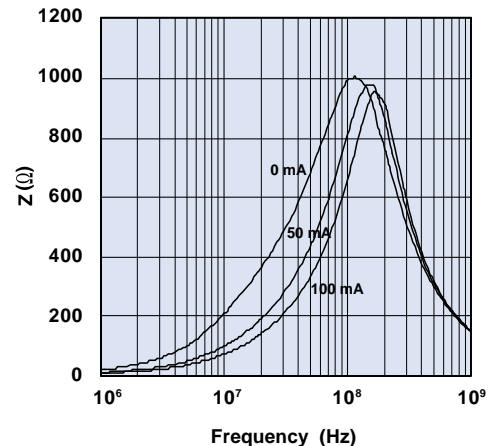
**Figure 23A** Impedance, reactance, and resistance vs. frequency for chip bead 2508056017Y0.



**Figure 23B** Impedance vs. frequency with dc bias as parameter for chip bead 2508056017Y0.

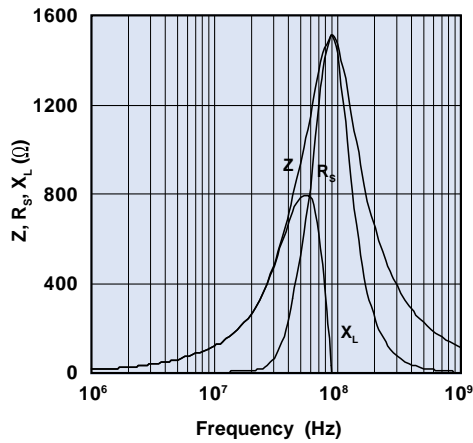


**Figure 24A** Impedance, reactance, and resistance vs. frequency for chip bead 2508051027Y0.

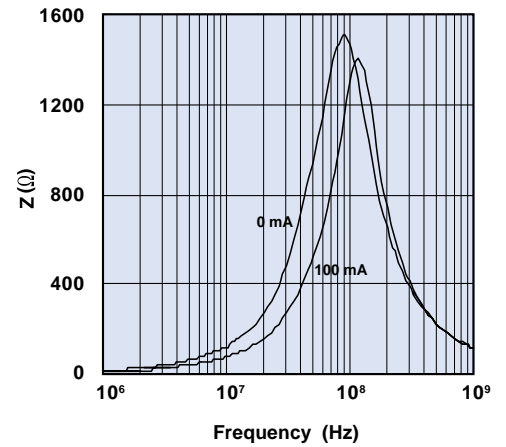


**Figure 24B** Impedance vs. frequency with dc bias as parameter for chip bead 2508051027Y0.

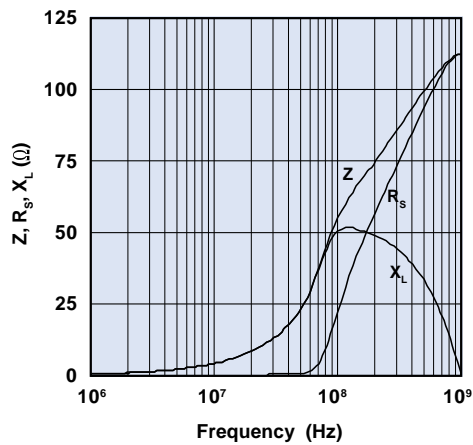
# Chip Beads



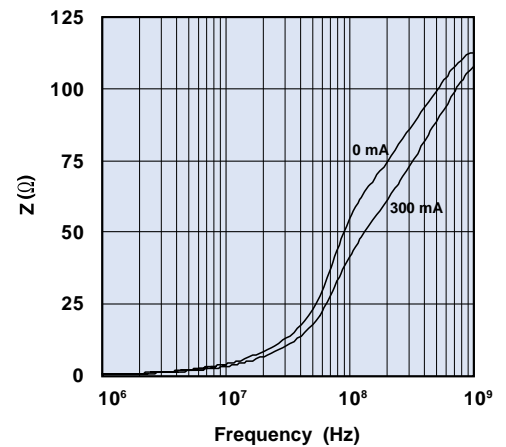
**Figure 25A** Impedance, reactance, and resistance vs. frequency for chip bead 2508051527Y0.



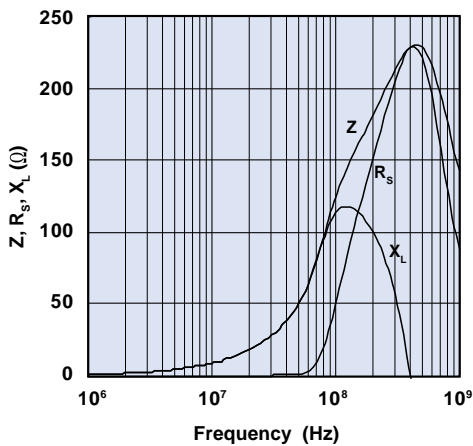
**Figure 25B** Impedance vs. frequency with dc bias as parameter for chip bead 2508051527Y0.



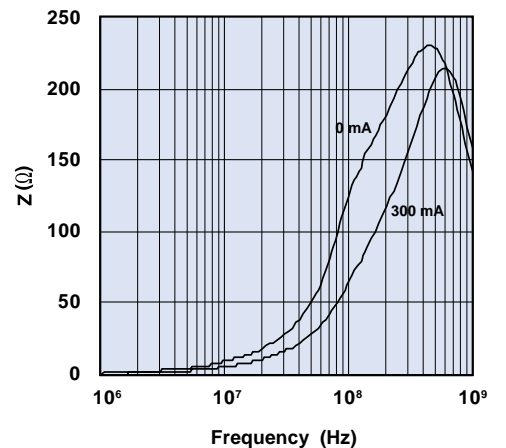
**Figure 26A** Impedance, reactance, and resistance vs. frequency for chip bead 2508056007Z0.



**Figure 26B** Impedance vs. frequency with dc bias as parameter for chip bead 2508056007Z0.

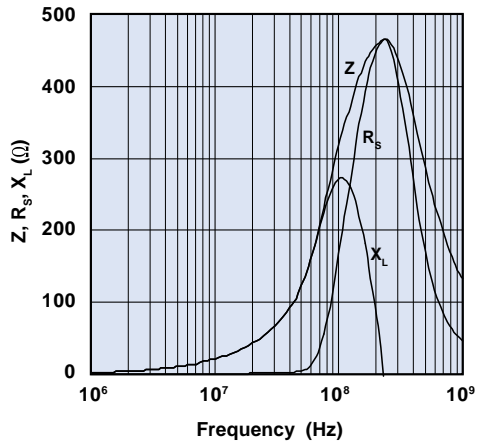


**Figure 27A** Impedance, reactance, and resistance vs. frequency for chip bead 2508051217Z0.

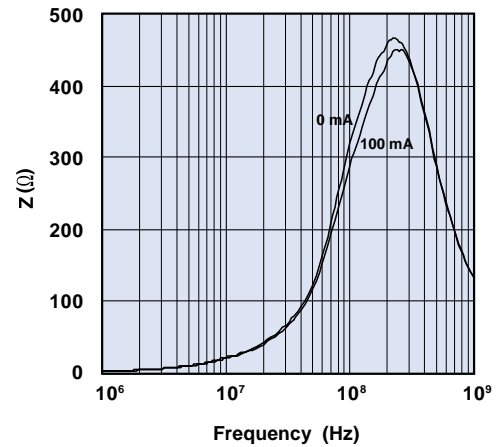


**Figure 27B** Impedance vs. frequency with dc bias as parameter for chip bead 2508051217Z0.

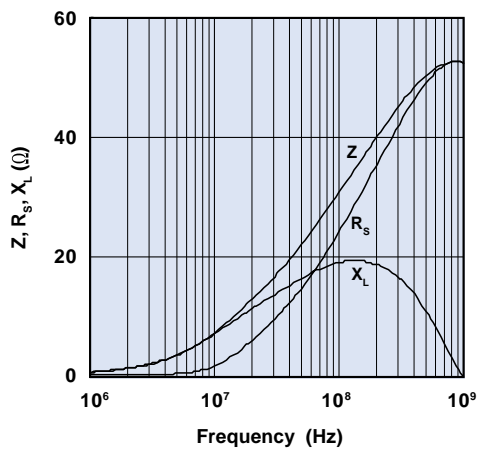
# Chip Beads



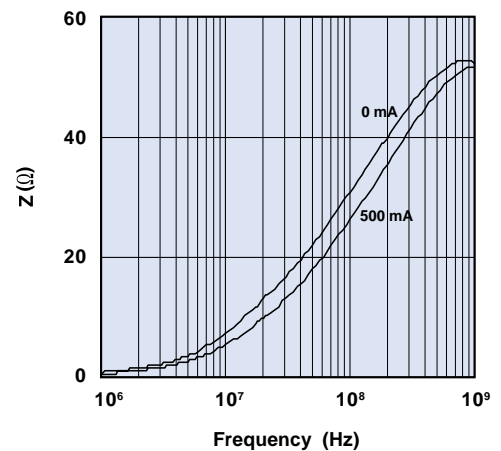
**Figure 28A** Impedance, reactance, and resistance vs. frequency for chip bead 2508053017Z0.



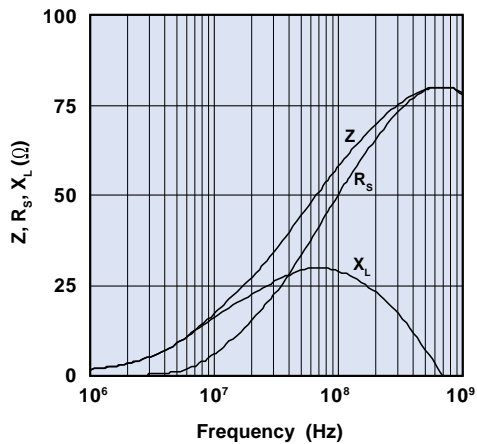
**Figure 28B** Impedance vs. frequency with dc bias as parameter for chip bead 2508053017Z0.



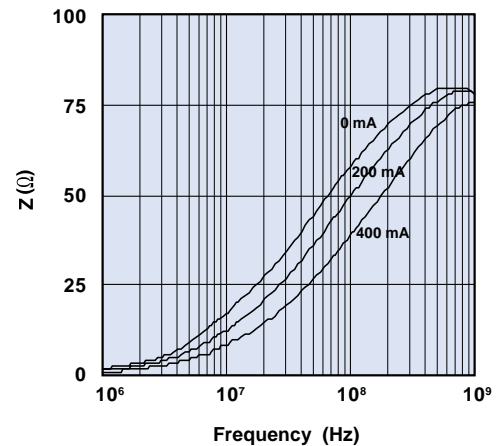
**Figure 29A** Impedance, reactance, and resistance vs. frequency for chip bead 2512063007Y0.



**Figure 29B** Impedance vs. frequency with dc bias as parameter for chip bead 2512063007Y0.

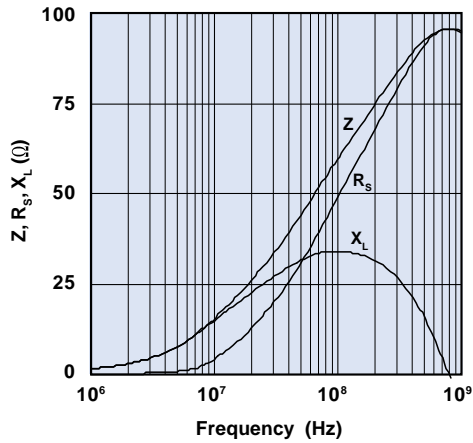


**Figure 30A** Impedance, reactance, and resistance vs. frequency for chip bead 2512065007Y0.

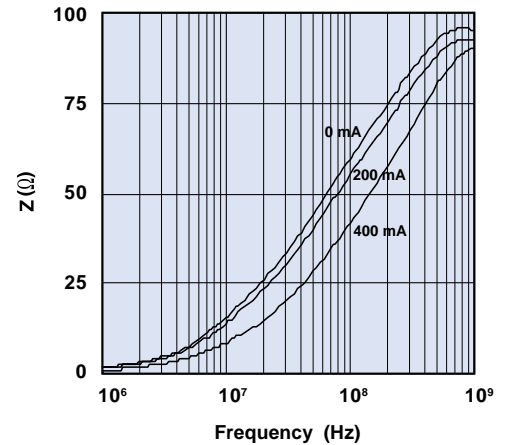


**Figure 30B** Impedance vs. frequency with dc bias as parameter for chip bead 2512065007Y0.

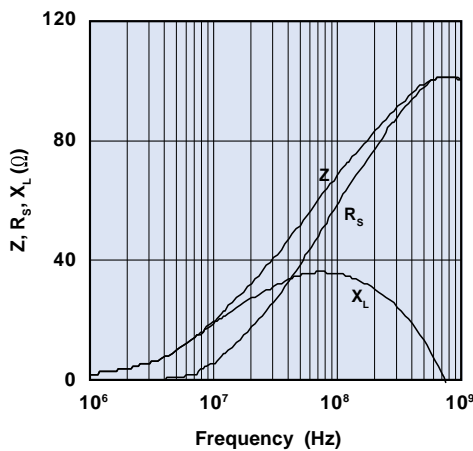
# Chip Beads



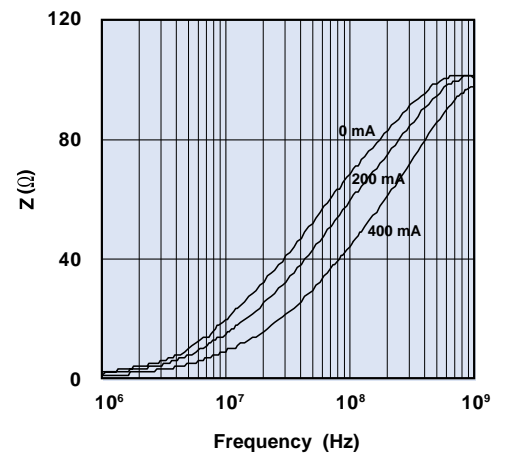
**Figure 31A** Impedance, reactance, and resistance vs. frequency for chip bead 2512066007Y0.



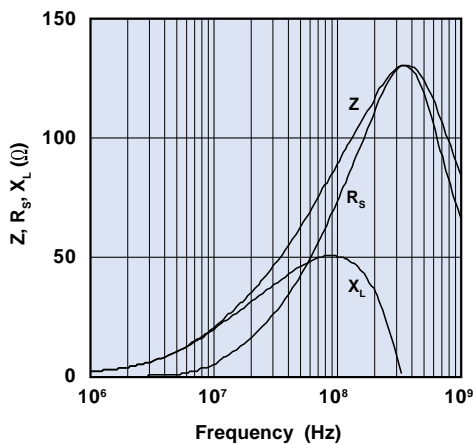
**Figure 31B** Impedance vs. frequency with dc bias as parameter for chip bead 2512066007Y0.



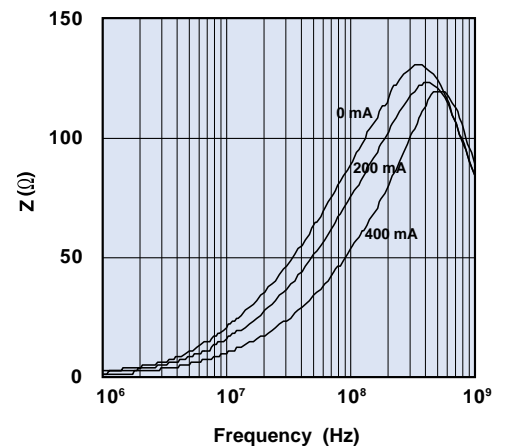
**Figure 32A** Impedance, reactance, and resistance vs. frequency for chip bead 2512067007Y0.



**Figure 32B** Impedance vs. frequency with dc bias as parameter for chip bead 2512067007Y0.

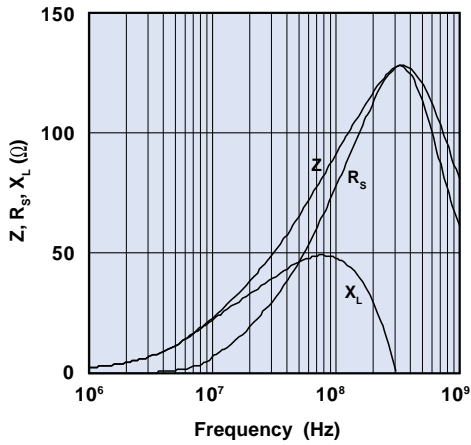


**Figure 33A** Impedance, reactance, and resistance vs. frequency for chip bead 2512068007Y0.

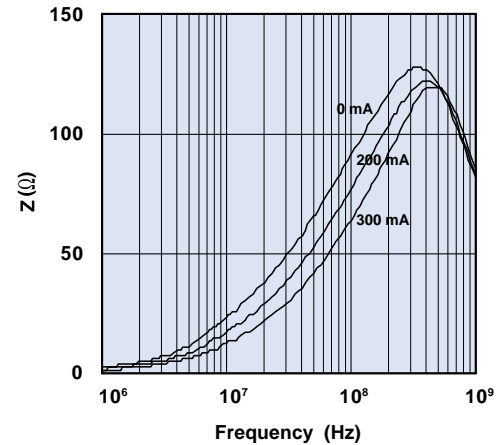


**Figure 33B** Impedance vs. frequency with dc bias as parameter for chip bead 2512068007Y0.

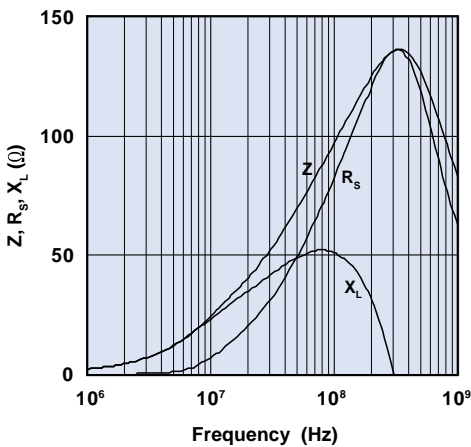
# Chip Beads



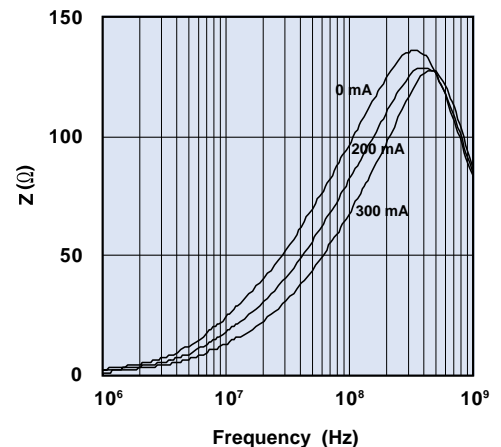
**Figure 34A** Impedance, reactance, and resistance vs. frequency for chip bead 2512069007Y0.



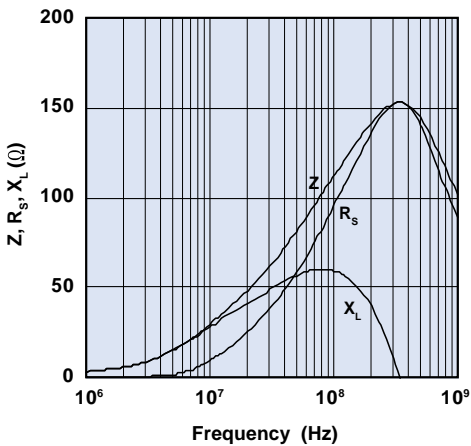
**Figure 34B** Impedance vs. frequency with dc bias as parameter for chip bead 2512069007Y0.



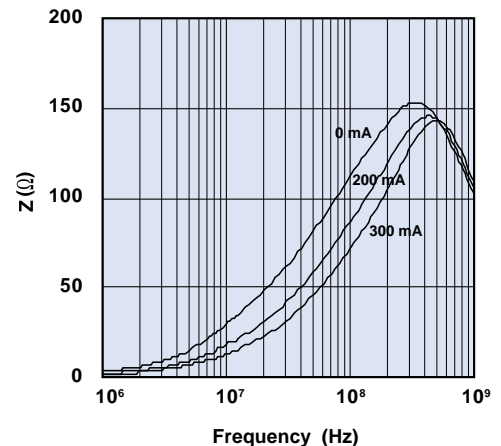
**Figure 35A** Impedance, reactance, and resistance vs. frequency for chip bead 2512061017Y0.



**Figure 35B** Impedance vs. frequency with dc bias as parameter for chip bead 2512061017Y0.



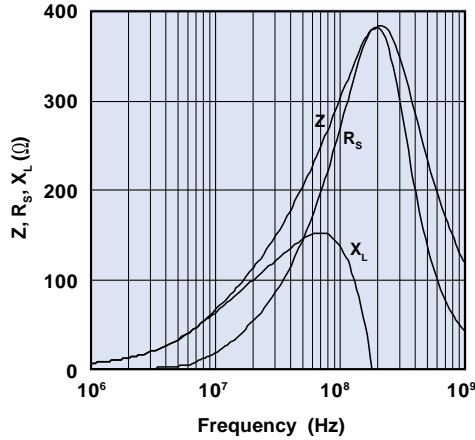
**Figure 36A** Impedance, reactance, and resistance vs. frequency for chip bead 2512061217Y0.



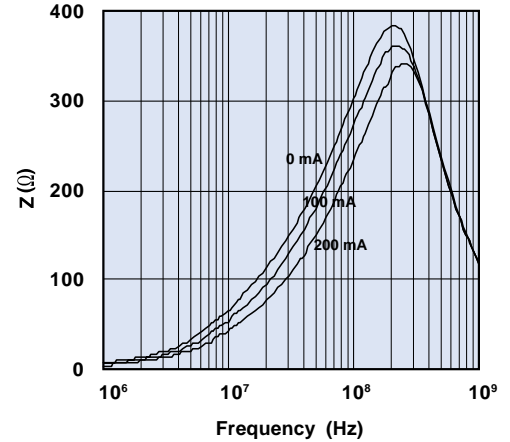
**Figure 36B** Impedance vs. frequency with dc bias as parameter for chip bead 2512061217Y0.



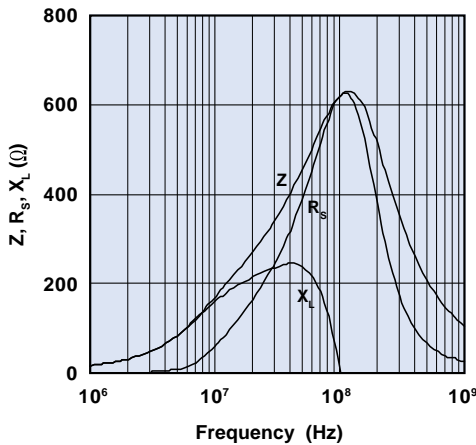
# Chip Beads



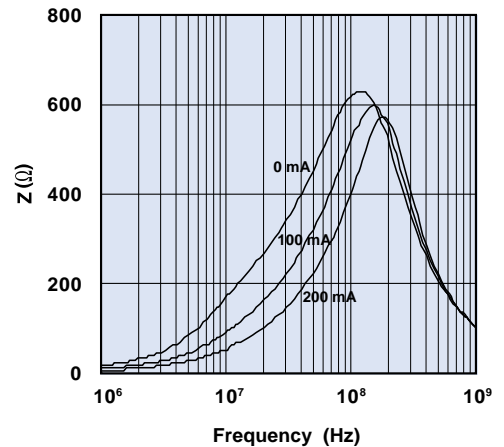
**Figure 37A** Impedance, reactance, and resistance vs. frequency for chip bead 2512063017Y0.



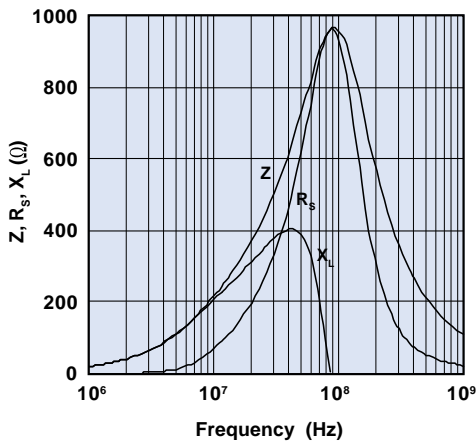
**Figure 37B** Impedance vs. frequency with dc bias as parameter for chip bead 2512063017Y0.



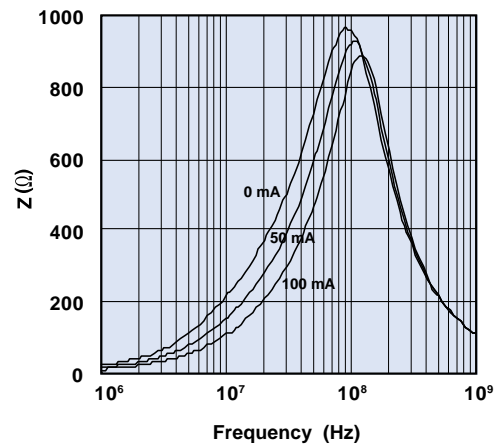
**Figure 38A** Impedance, reactance, and resistance vs. frequency for chip bead 2512066017Y0.



**Figure 38B** Impedance vs. frequency with dc bias as parameter for chip bead 2512066017Y0.

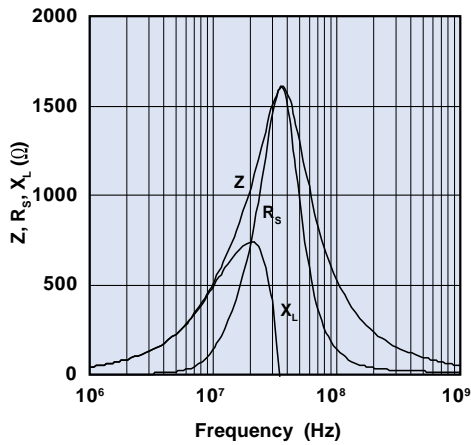


**Figure 39A** Impedance, reactance, and resistance vs. frequency for chip bead 2512061027Y0.

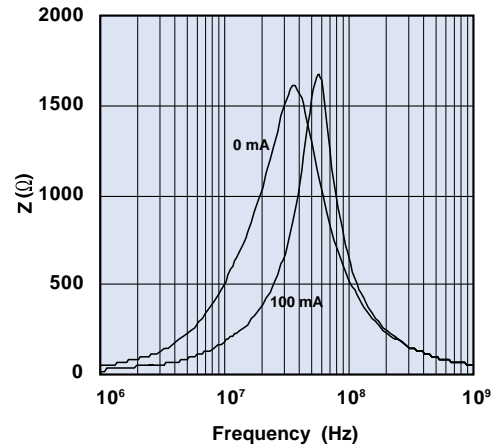


**Figure 39B** Impedance vs. frequency with dc bias as parameter for chip bead 2512061027Y0.

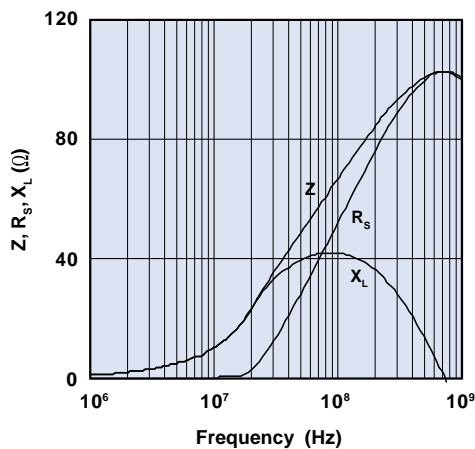
# Chip Beads



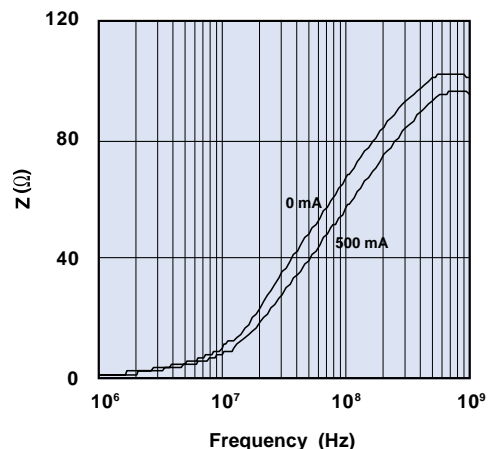
**Figure 40A** Impedance, reactance, and resistance vs. frequency for chip bead 2512061527Y0.



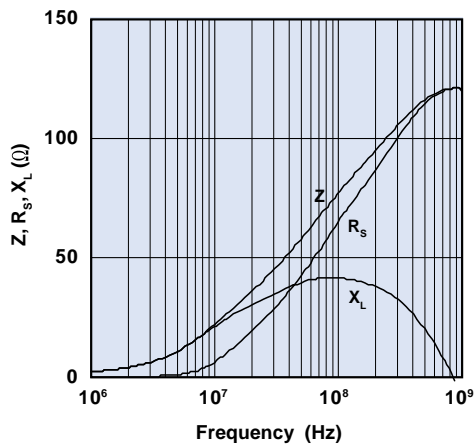
**Figure 40B** Impedance vs. frequency with dc bias as parameter for chip bead 2512061527Y0.



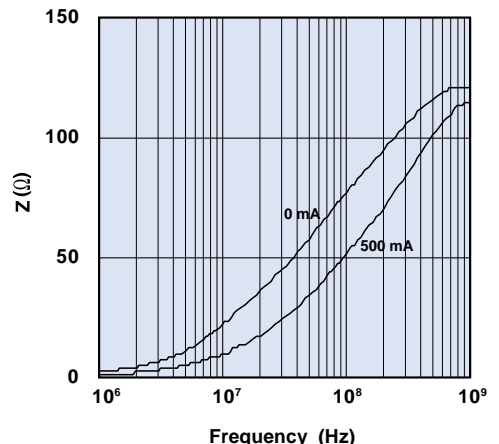
**Figure 41A** Impedance, reactance, and resistance vs. frequency for chip bead 2518066007Y0.



**Figure 41B** Impedance vs. frequency with dc bias as parameter for chip bead 2518066007Y0.

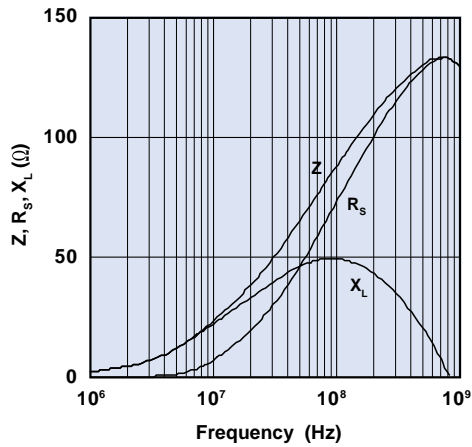


**Figure 42A** Impedance, reactance, and resistance vs. frequency for chip bead 2518067007Y0.

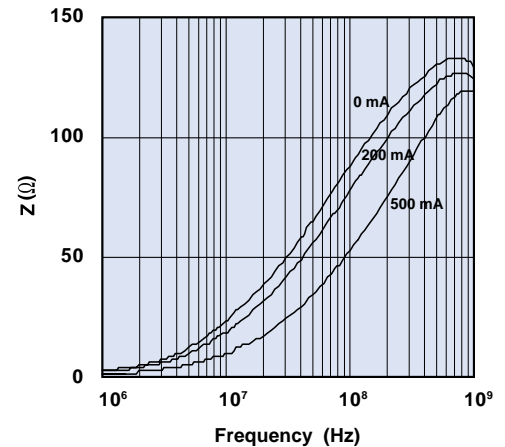


**Figure 42B** Impedance vs. frequency with dc bias as parameter for chip bead 2518067007Y0.

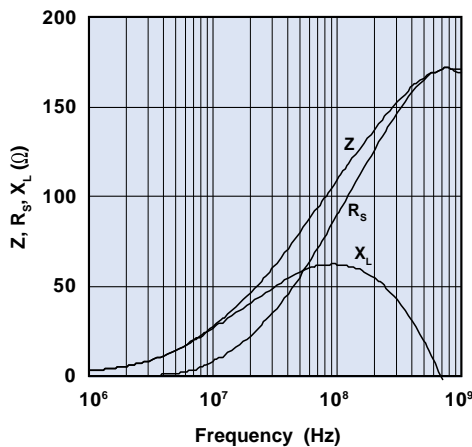
# Chip Beads



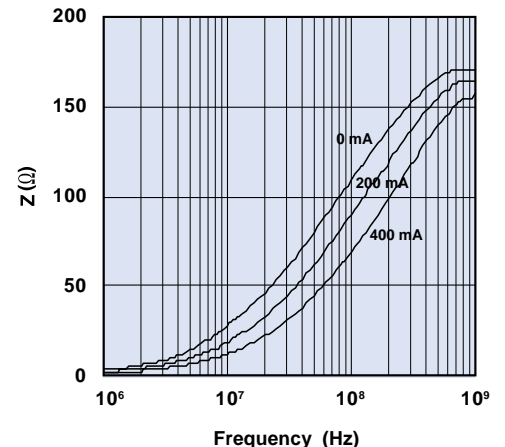
**Figure 43A** Impedance, reactance, and resistance vs. frequency for chip bead 2518068007Y0.



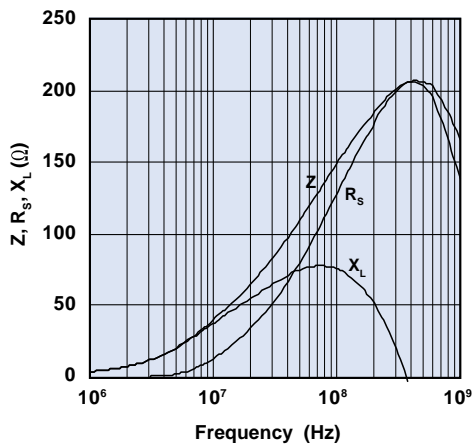
**Figure 43B** Impedance vs. frequency with dc bias as parameter for chip bead 2518068007Y0.



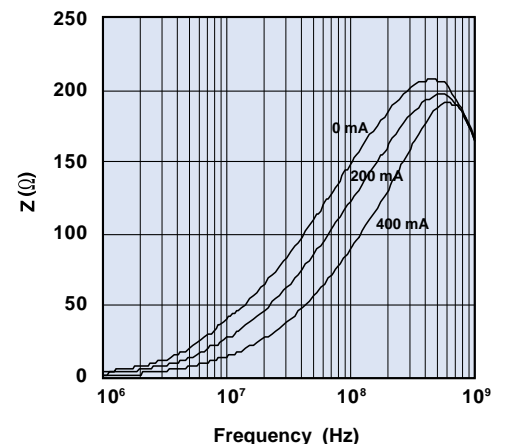
**Figure 44A** Impedance, reactance, and resistance vs. frequency for chip bead 2518061017Y0.



**Figure 44B** Impedance vs. frequency with dc bias as parameter for chip bead 2518061017Y0.

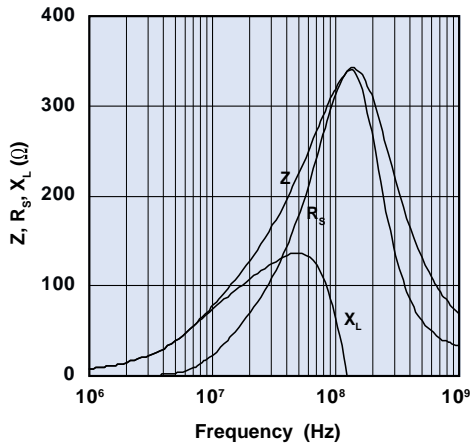


**Figure 45A** Impedance, reactance, and resistance vs. frequency for chip bead 2518061517Y0.

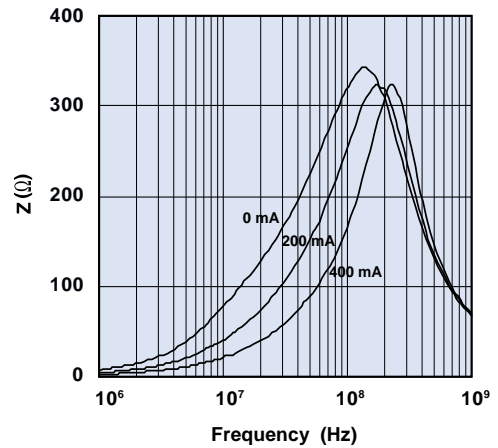


**Figure 45B** Impedance vs. frequency with dc bias as parameter for chip bead 2518061517Y0.

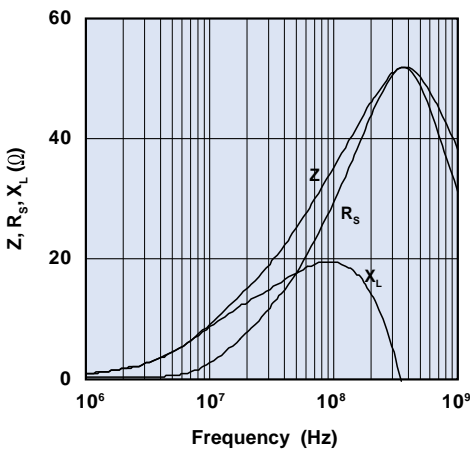
# Chip Beads



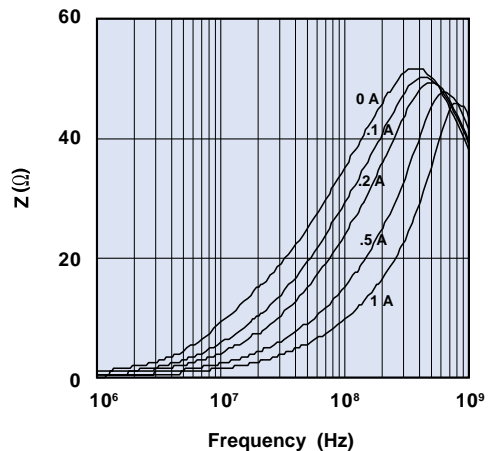
**Figure 46A** Impedance, reactance, and resistance vs. frequency for chip bead 2518063017Y0.



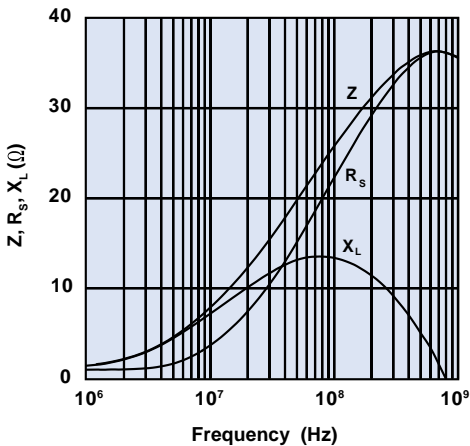
**Figure 46B** Impedance vs. frequency with dc bias as parameter for chip bead 2518063017Y0.



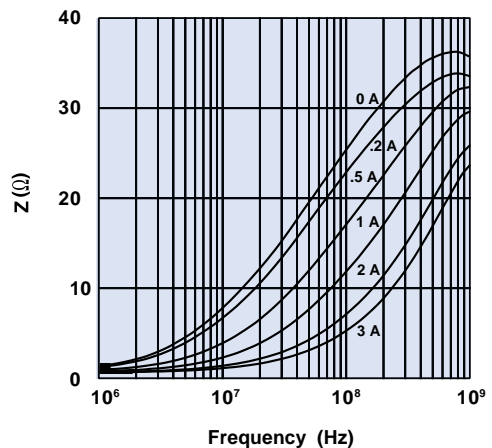
**Figure 47A** Impedance, reactance, and resistance vs. frequency for chip bead 2506033007Y1.



**Figure 47B** Impedance vs. frequency with dc bias as parameter for chip bead 2506033007Y1.

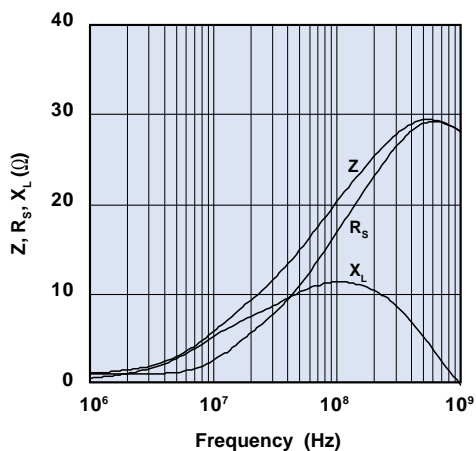


**Figure 48A** Impedance, reactance, and resistance vs. frequency for chip bead 2508053007Y3.

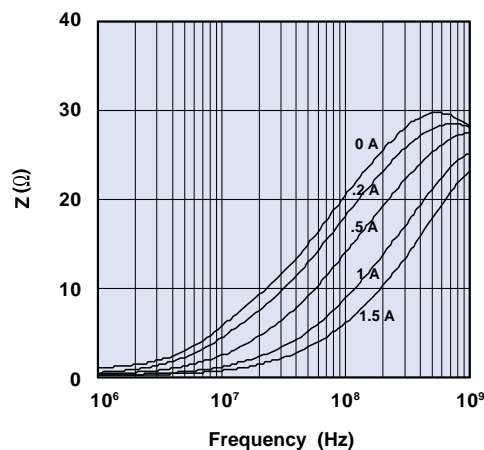


**Figure 48B** Impedance vs. frequency with dc bias as parameter for chip bead 2508053007Y3.

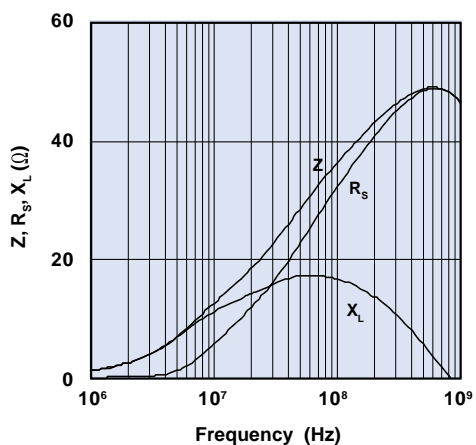
# Chip Beads



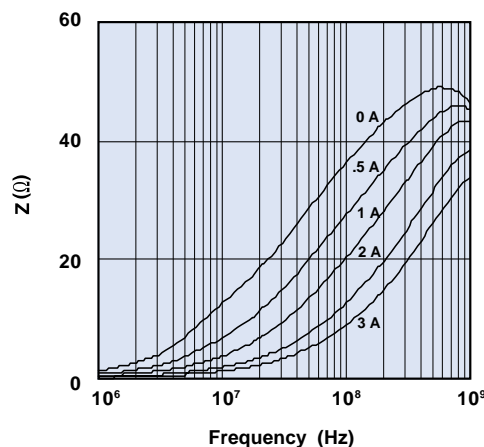
**Figure 49A** Impedance, reactance, and resistance vs. frequency for chip bead 2512061907Y1.



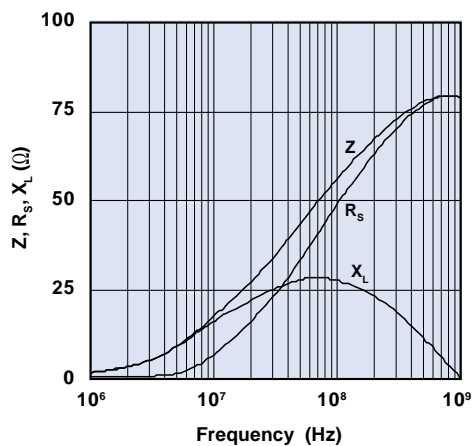
**Figure 49B** Impedance vs. frequency with dc bias as parameter for chip bead 2512061907Y1.



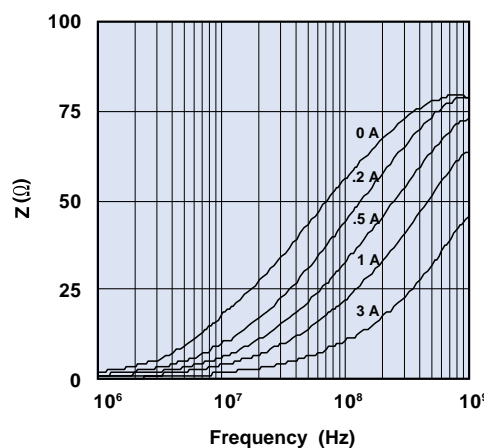
**Figure 50A** Impedance, reactance, and resistance vs. frequency for chip bead 2512063007Y3.



**Figure 50B** Impedance vs. frequency with dc bias as parameter for chip bead 2512063007Y3.

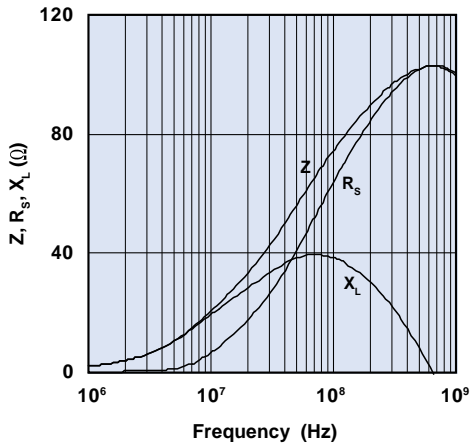


**Figure 51A** Impedance, reactance, and resistance vs. frequency for chip bead 2512065007Y3.

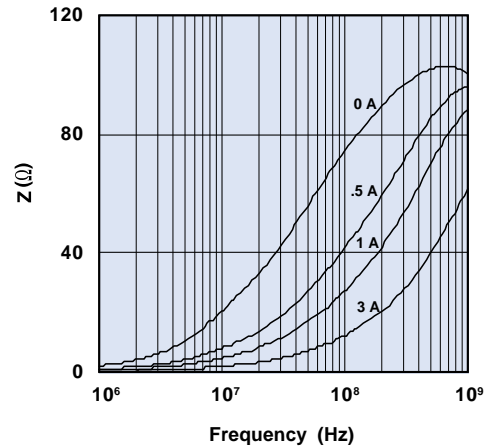


**Figure 51B** Impedance vs. frequency with dc bias as parameter for chip bead 2512065007Y3.

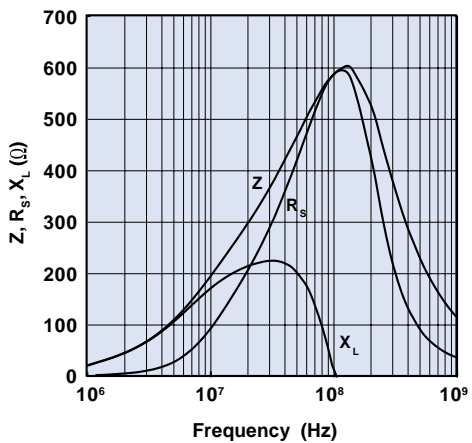
# Chip Beads



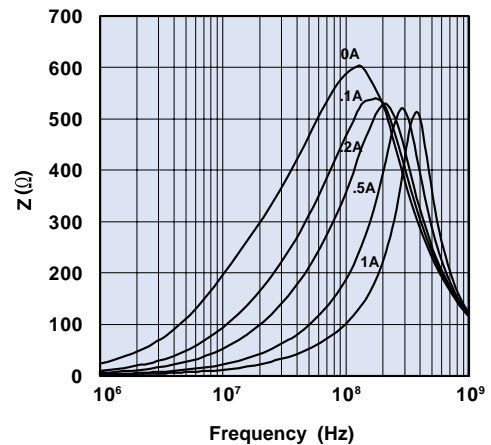
**Figure 52A** Impedance, reactance, and resistance vs. frequency for chip bead 2512067007Y3.



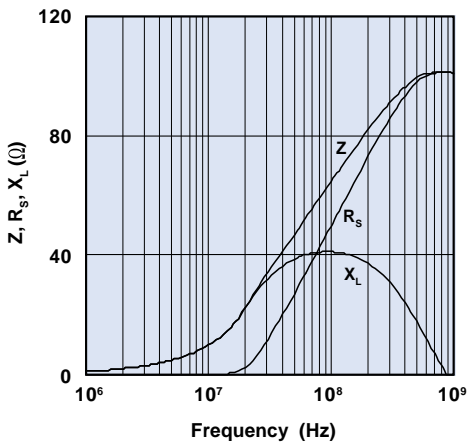
**Figure 52B** Impedance vs. frequency with dc bias as parameter for chip bead 2512067007Y3.



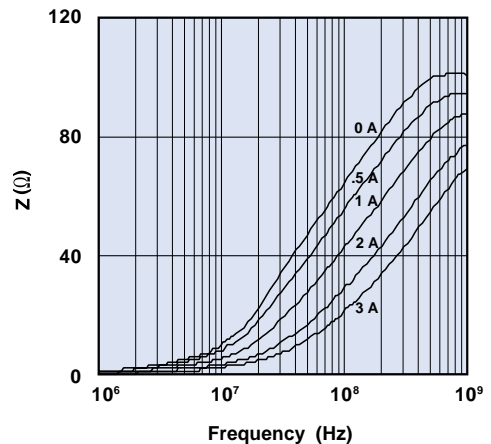
**Figure 53A** Impedance, reactance, and resistance vs. frequency for chip bead 2512066017Y1.



**Figure 53B** Impedance vs. frequency with dc bias as parameter for chip bead 2512066017Y1.

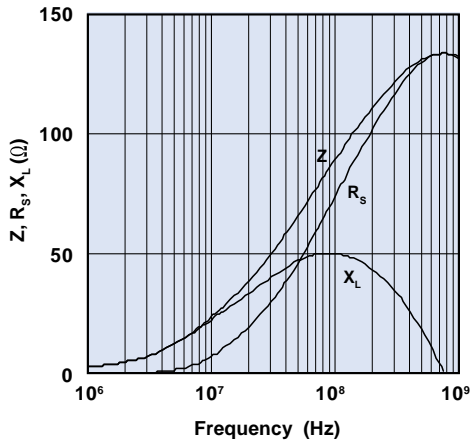


**Figure 54A** Impedance, reactance, and resistance vs. frequency for chip bead 2518066007Y3.

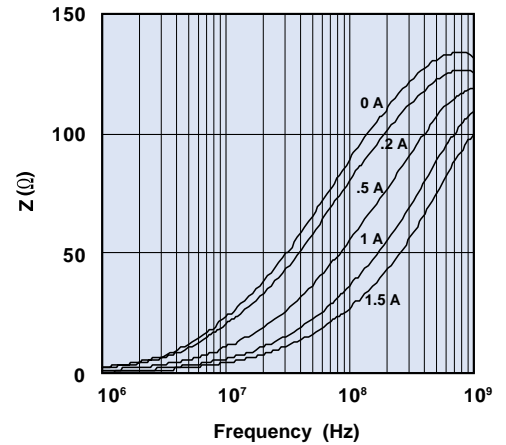


**Figure 54B** Impedance vs. frequency with dc bias as parameter for chip bead 2518066007Y3.

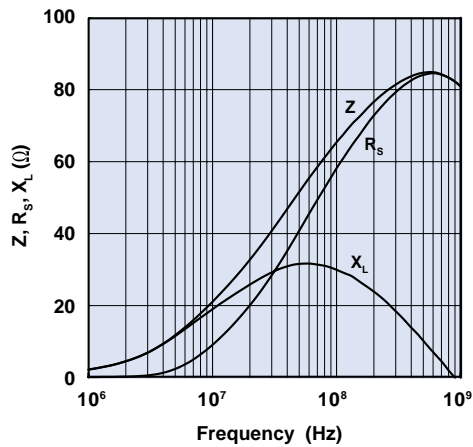
# Chip Beads



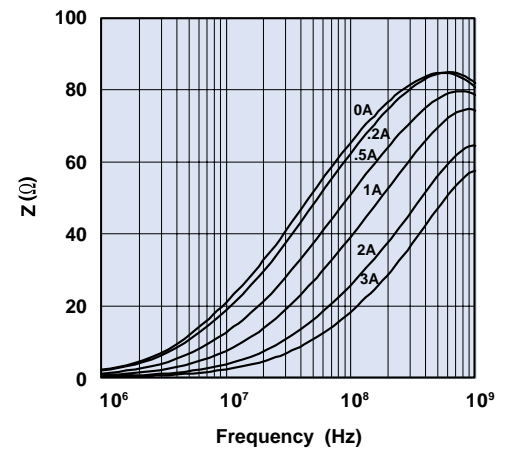
**Figure 55A** Impedance, reactance, and resistance vs. frequency for chip bead 2518068007Y1.



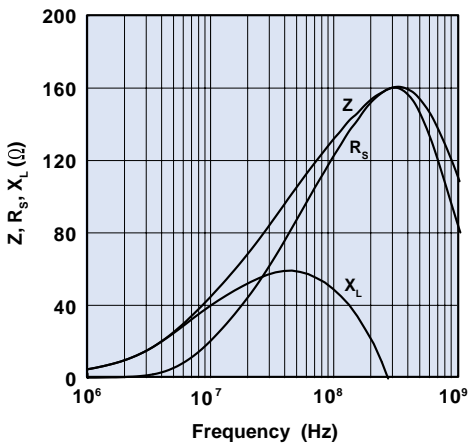
**Figure 55B** Impedance vs. frequency with dc bias as parameter for chip bead 2518068007Y1.



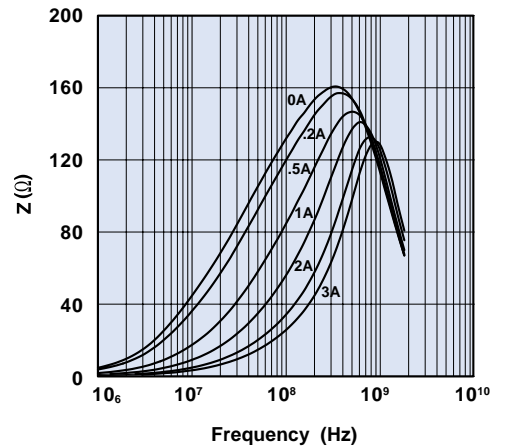
**Figure 56A** Impedance, reactance, and resistance vs. frequency for chip bead 251812007Y3.



**Figure 56B** Impedance vs. frequency with dc bias as parameter for chip bead 251812007Y3.

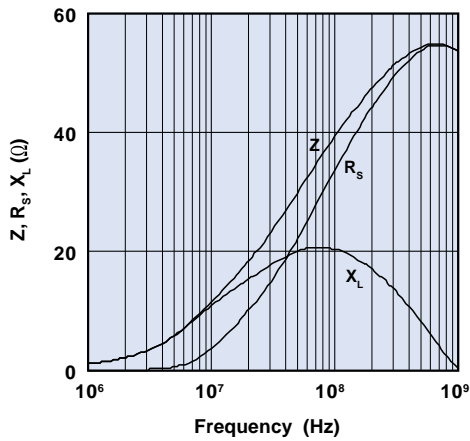


**Figure 57A** Impedance, reactance, and resistance vs. frequency for chip bead 2518121217Y3.

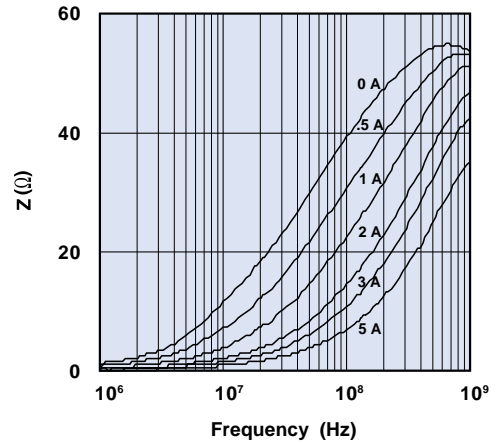


**Figure 57B** Impedance vs. frequency with dc bias as parameter for chip bead 2518121217Y3.

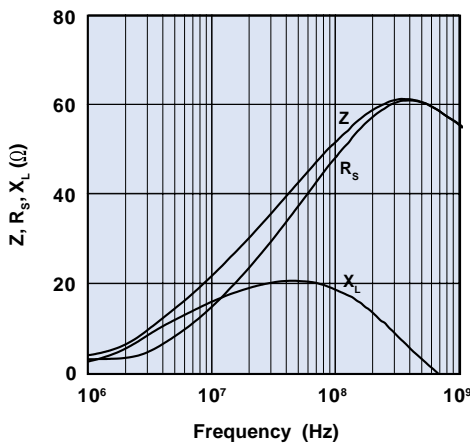
# Chip Beads



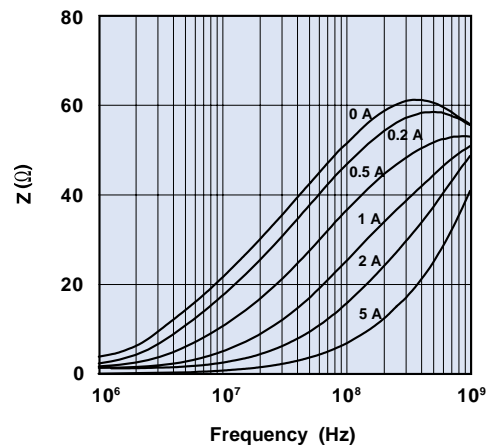
**Figure 58A** Impedance, reactance, and resistance vs. frequency for chip bead 2512065007Y6.



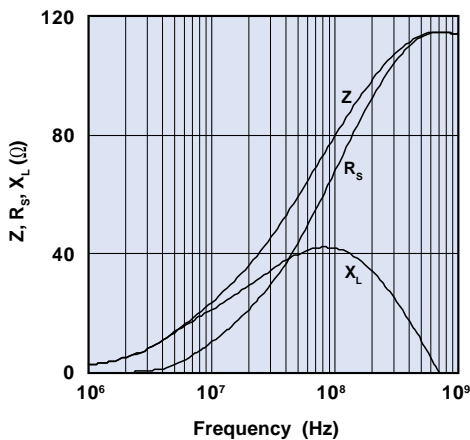
**Figure 59B** Impedance vs. frequency with dc bias as parameter for chip bead 2512065007Y6.



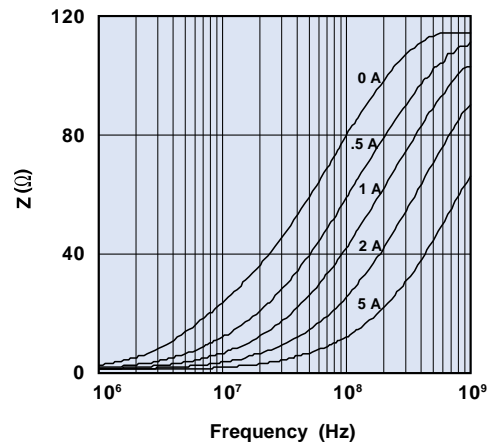
**Figure 59A** Impedance, reactance, and resistance vs. frequency for chip bead 2518065007Y6.



**Figure 59B** Impedance vs. frequency with dc bias as parameter for chip bead 2518065007Y6.



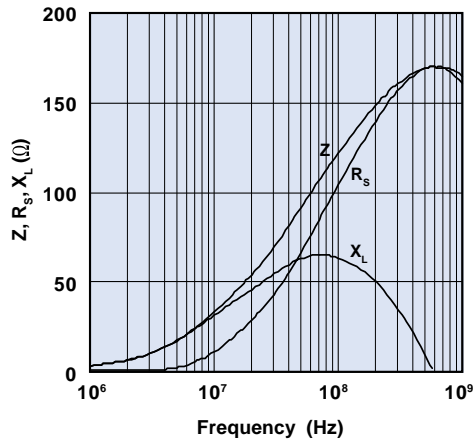
**Figure 60A** Impedance, reactance, and resistance vs. frequency for chip bead 2518068007Y6.



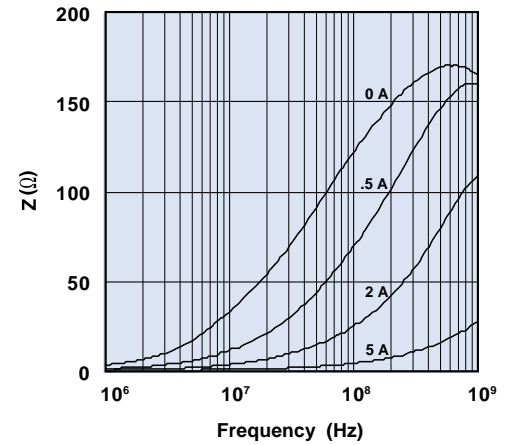
**Figure 60B** Impedance vs. frequency with dc bias as parameter for chip bead 2518068007Y6.



# Chip Beads



**Figure 61A** Impedance, reactance, and resistance vs. frequency for chip bead 2518121217Y6.



**Figure 61B** Impedance vs. frequency with dc bias as parameter for chip bead 2518121217Y6.

# PC Beads

Multiple single turn printed circuit beads or multi-turn printed circuit beads are available in Fair-Rite 44 material. These through-hole parts are supplied in two wire lengths.

- Jumper wires are oxygen free high conductivity copper with a tin/lead coating.
- Beads are controlled for impedance limits only. They are tested for impedance with a single turn through two end holes, using a Hewlett Packard HP 4193A Vector Impedance Meter.
- Wires on top of the beads are covered with a layer of an epoxy.
- Recommended operating and storage temperature for these beads is  $-55^{\circ}\text{C}$  to  $+125^{\circ}\text{C}$ .
- For impedance vs. frequency curves and dc bias curves for these parts, see Figures 9-12.
- For any PC bead requirement not listed in the catalog, please contact our customer service group for availability and pricing.

**Dimensions** (Bold numbers are in millimeters, light numbers are nominal in inches.)

Part Number*	Fig.	A	B	C Max.	D	E	F Min.	G	Wt (g)	Typical Impedance ( $\Omega$ ) <sup>1</sup>		Z, R <sub>s</sub> , X <sub>L</sub> vs. Frequency Curve	DC Bias Curve
										25 MHz	100 MHz		
<b>2944776101</b>	1	<b>8.0 - 0.35</b> .308	<b>7.6 - 0.5</b> .290	<b>11.8</b> .465	<b>2.54±0.1</b> .100	<b>2.54±0.1</b> .100	<b>2.4</b> .095	<b>0.65</b> 22 AWG	2.6	188	288	Figure 9A	Figure 9B
<b>2944776102</b>	1	<b>8.0 - 0.35</b> .308	<b>7.6 - 0.5</b> .290	<b>11.8</b> .465	<b>2.54±0.1</b> .100	<b>2.54±0.1</b> .100	<b>3.1</b> .125	<b>0.65</b> 22 AWG	2.6	188	288	Figure 9A	Figure 9B
<b>2944778101</b>	2	<b>11.2 - 0.5</b> .430	<b>5.75 - 0.5</b> .216	<b>11.8</b> .465	<b>2.54±0.1</b> .100	<b>2.54±0.1</b> .100	<b>2.4</b> .095	<b>0.65</b> 22 AWG	2.7	188	288	Figure 10A	Figure 10B
<b>2944778102</b>	2	<b>11.2 - 0.5</b> .430	<b>5.75 - 0.5</b> .216	<b>11.8</b> .465	<b>2.54±0.1</b> .100	<b>2.54±0.1</b> .100	<b>3.1</b> .125	<b>0.65</b> 22 AWG	2.7	188	288	Figure 10A	Figure 10B
<b>2944778301</b>	3	<b>11.2 - 0.5</b> .430	<b>11.2 - 0.5</b> .430	<b>11.8</b> .465	<b>2.54±0.1</b> .100	<b>7.6±0.2</b> .300	<b>2.4</b> .095	<b>0.65</b> 22 AWG	6.0	219	338	Figure 11A	Figure 11B
<b>2944778302</b>	3	<b>11.2 - 0.5</b> .430	<b>11.2 - 0.5</b> .430	<b>11.8</b> .465	<b>2.54±0.1</b> .100	<b>7.6±0.2</b> .300	<b>3.1</b> .125	<b>0.65</b> 22 AWG	6.0	219	338	Figure 11A	Figure 11B
<b>2944770301</b>	4	<b>13.45±0.25</b> .530	<b>11.2 - 0.5</b> .430	<b>11.8</b> .465	<b>2.54±0.1</b> .100	<b>7.6±0.2</b> .300	<b>2.4</b> .095	<b>0.65</b> 22 AWG	7.4	219	338	Figure 12A	Figure 12B
<b>2944770302</b>	4	<b>13.45±0.25</b> .530	<b>11.2 - 0.5</b> .430	<b>11.8</b> .465	<b>2.54±0.1</b> .100	<b>7.6±0.2</b> .300	<b>3.1</b> .125	<b>0.65</b> 22 AWG	7.4	219	338	Figure 12A	Figure 12B

\*Bold numbers designate preferred parts.

<sup>1</sup>Guaranteed Z Min is Z Typ -20%

# PC Beads

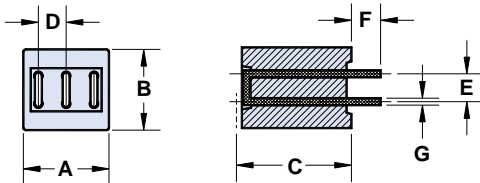


Figure 1

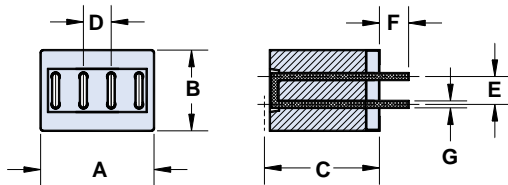


Figure 2

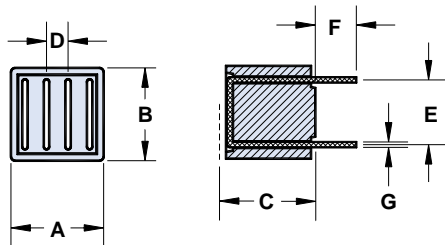


Figure 3

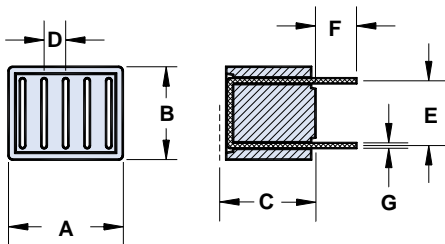


Figure 4

## Typical Printed Circuit Board Layouts

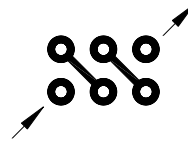


Figure 1A:  
2944776101 and 2944776102 with 3 turns

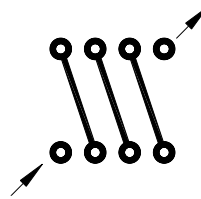


Figure 3A:  
2944778301  
and 2944778302  
with 4 turns

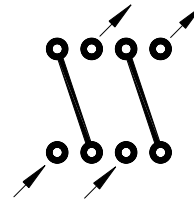


Figure 3B:  
2944778301  
and 2944778302  
with 2x2 turns

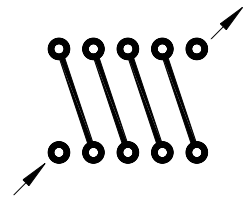
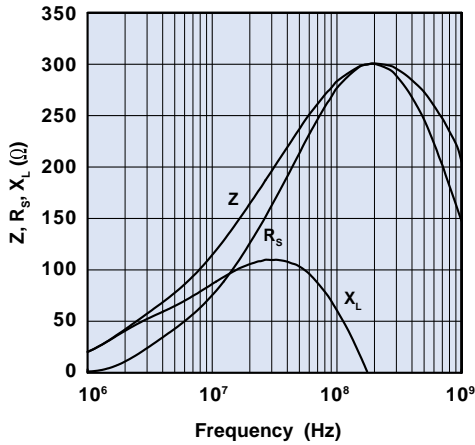
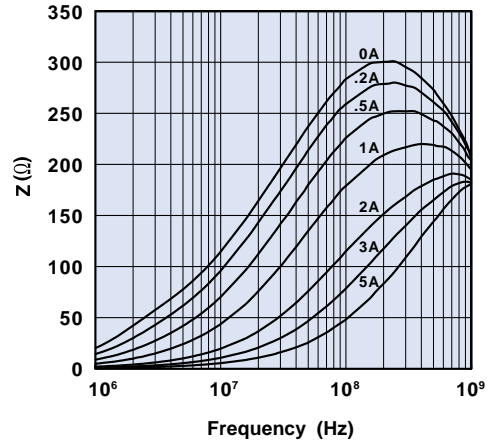


Figure 4A:  
2944770301  
and 2944770302  
with 5 turns

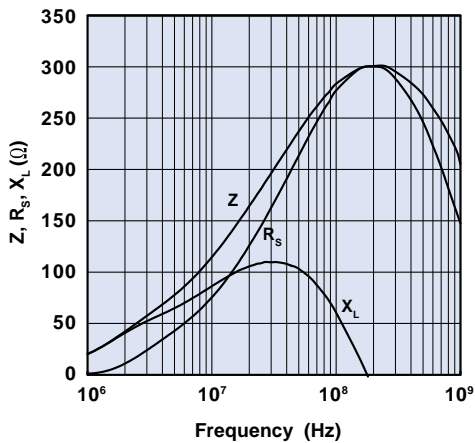
# PC Beads



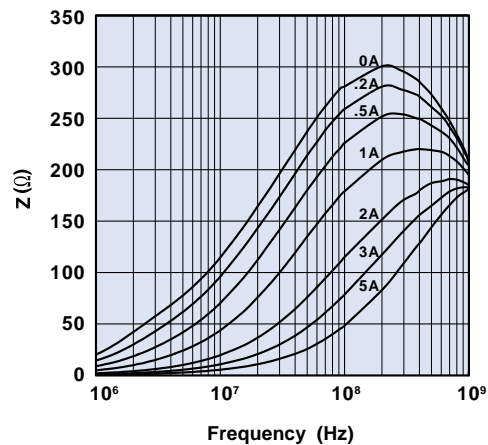
**Figure 9A** Impedance, reactance, and resistance vs. frequency for PC bead 2944776101 and 2944776102.



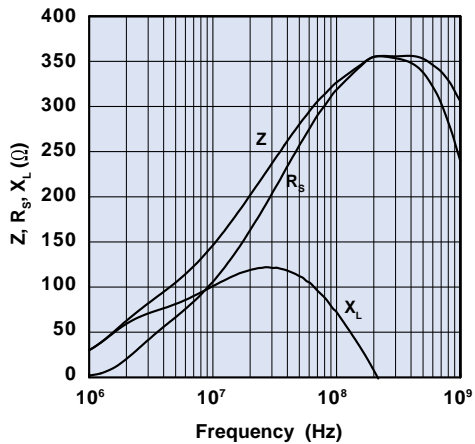
**Figure 9B** Impedance vs. frequency with dc bias as parameter for PC bead 2944776101 and 2944776102.



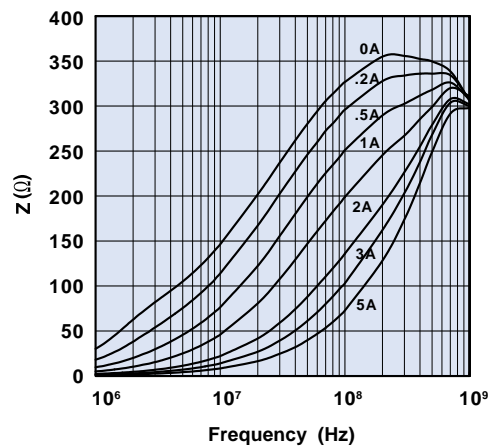
**Figure 10A** Impedance, reactance, and resistance vs. frequency for PC bead 2944778101 and 2944778102.



**Figure 10B** Impedance vs. frequency with dc bias as parameter for PC bead 2944778101 and 2944778102.

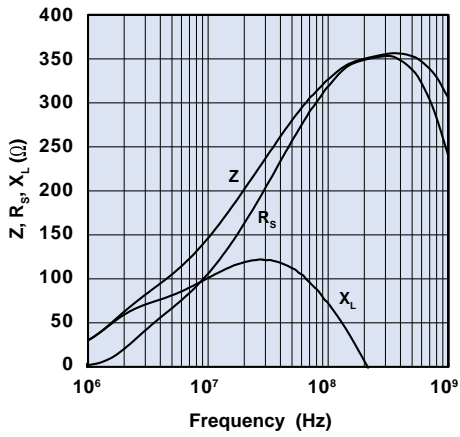


**Figure 11A** Impedance, reactance, and resistance vs. frequency for PC bead 2944778301 and 2944778302.

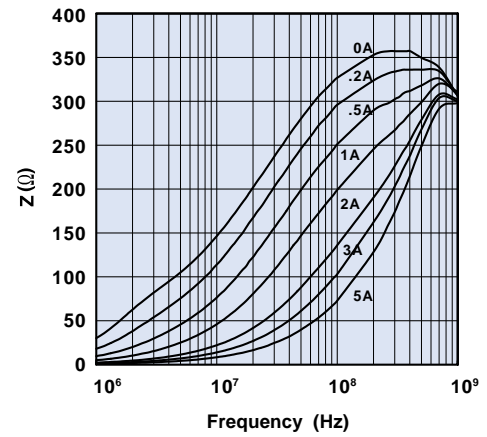


**Figure 11B** Impedance vs. frequency with dc bias as parameter for PC bead 2944778301 and 2944778302.

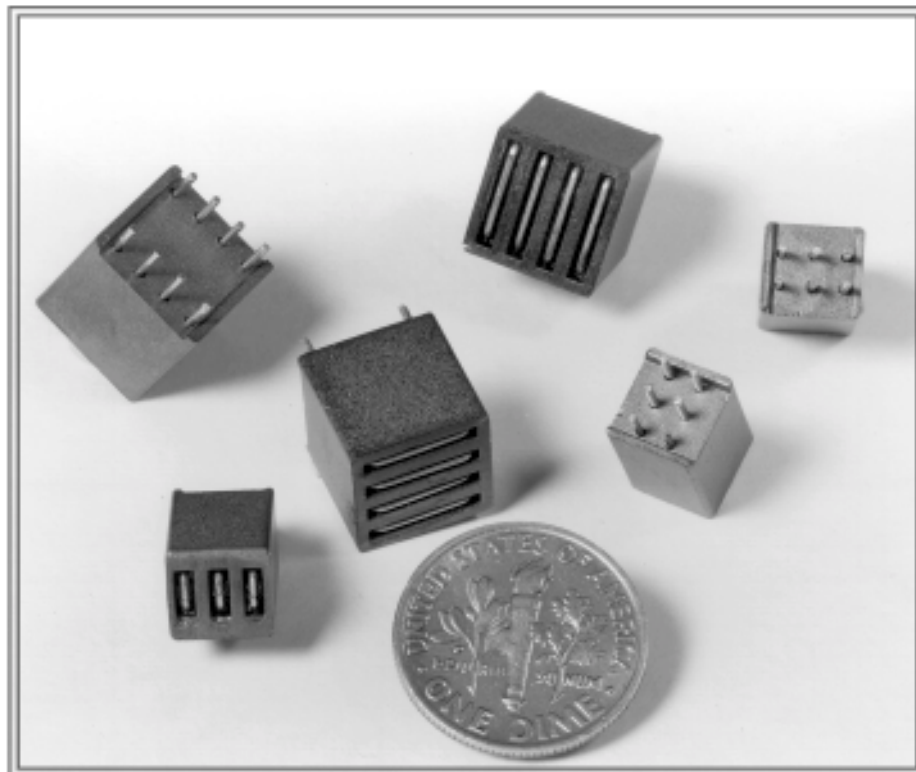
# PC Beads



**Figure 12A** Impedance, reactance, and resistance vs. frequency for PC bead 2944770301 and 2944770302.



**Figure 12B** Impedance vs. frequency with dc bias as parameter for PC bead 2944770301 and 2944770302.



# Wound Beads

Six and eleven hole beads are available both as beads and wound with tinned copper wire in several winding configurations.

- Parts with a "1" as the last digit of the part number are supplied bulk packed. Parts 29 - - 666651 and 29 - - 666631 can be supplied radially taped and reeled per EIA Standard 468-B. This packing method will change the last digit of the part number to a "4". Taped and reeled parts are supplied 500 pieces on a 13" reel.
- Wire used for winding is oxygen free high conductivity copper with a tin/lead plating.
- Beads are controlled for impedance limits only. They are tested for impedance using a Hewlett Packard HP 4193A Vector Impedance Meter for beads in 44 material and the HP 4191A RF Impedance Analyzer for 61 material beads.
- Recommended storage temperature and operating temperature is  $-55^{\circ}\text{C}$  to  $125^{\circ}\text{C}$ .
- For impedance vs. frequency curves and DC bias curves for these parts, see Figures 3-14.
- For any wound bead requirement not listed in the catalog, please contact our customer service group for availability and pricing.
- The Wound-Bead Kit (part number 0199000027) is available for prototype evaluation. See page 92.

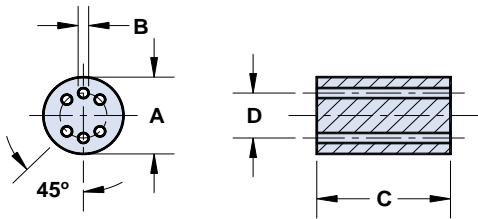


Figure 1

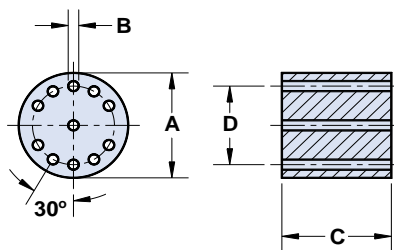


Figure 2

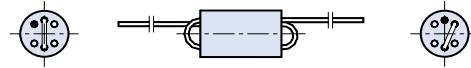


Figure 1-1

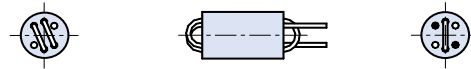


Figure 1-2

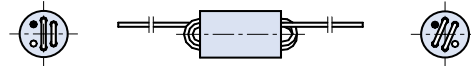


Figure 1-3

# Wound Beads



Figure 1-4

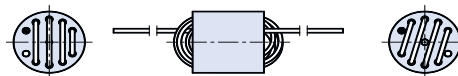


Figure 2-1

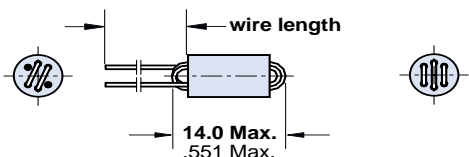


Figure 1-5

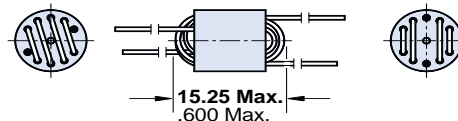


Figure 2-2

Dimensions (Bold numbers are in millimeters, light numbers are nominal in inches.)

Part Number*	Fig.	A	B	C	D <sub>Ref</sub>	Wt (g)	Typical Impedance (Ω) <sup>1</sup>			
							10 MHz	50 MHz	100 MHz	200 MHz
2644666611 <sup>①</sup>	1	<b>6.0±0.25</b> .236	<b>0.75+0.15</b> .032	<b>10.0±0.25</b> .394	<b>3.5</b> .138	1.2	213	400	470	—
2661666611 <sup>①</sup>	1	<b>6.0±0.25</b> .236	<b>0.75+0.15</b> .032	<b>10.0±0.25</b> .394	<b>3.5</b> .138	1.2	—	315	500	405
2644777711 <sup>②</sup>	2	<b>10.0±0.25</b> .394	<b>0.9+0.15</b> .038	<b>10.0±0.25</b> .394	<b>7.5</b> .295	3.3	375	905	500	—

① Tested with 1½ turns. ② Tested with 2½ turns. (A ½ turn is defined as a single pass through a hole.)

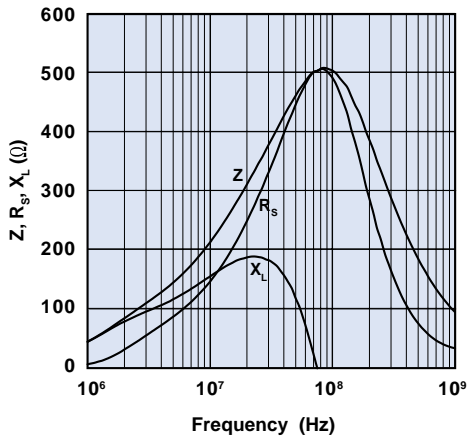
Part Number*	Fig.	Turns	Wire Size	Wire Length	Wt (g)	Typical Impedance (Ω) <sup>1</sup>				Z, R <sub>s</sub> , X <sub>L</sub> vs. Frequency Curve	DC Bias Curve
						10 MHz	50 MHz	100 MHz	200 MHz		
2944666661	1-1	1½	<b>0.53</b> 24 AWG	<b>38.0±3.0</b> 1.500	1.3	213	400	470	—	Figure 3A	Figure 3B
2961666661	1-1	1½	<b>0.53</b> 24 AWG	<b>38.0±3.0</b> 1.500	1.3	—	315	500	405	Figure 4A	Figure 4B
2944666651	1-2	2	<b>0.53</b> 24 AWG	<b>38.0±3.0</b> 1.500	1.3	300	650	600	—	Figure 5A	Figure 5B
2961666651	1-2	2	<b>0.53</b> 24 AWG	<b>38.0±3.0</b> 1.500	1.3	—	530	750	375	Figure 6A	Figure 6B
2944666671	1-3	2½	<b>0.53</b> 24 AWG	<b>38.0±3.0</b> 1.500	1.4	400	850	725	—	Figure 7A	Figure 7B
2961666671	1-3	2½	<b>0.53</b> 24 AWG	<b>38.0±3.0</b> 1.500	1.4	—	690	845	345	Figure 8A	Figure 8B
2944666681	1-4	2 x 1½	<b>0.53</b> 24 AWG	③	1.4	213	400	470	—	Figure 9A	Figure 9B
2961666681	1-4	2 x 1½	<b>0.53</b> 24 AWG	③	1.4	—	315	470	405	Figure 10A	Figure 10B
2944666631	1-5	3	<b>0.53</b> 24 AWG	<b>38.0±3.0</b> 1.500	1.4	500	1000	690	—	Figure 11A	Figure 11B
2961666631	1-5	3	<b>0.53</b> 24 AWG	<b>38.0±3.0</b> 1.500	1.4	—	815	780	315	Figure 12A	Figure 12B
2944777741	2-1	4½	<b>0.65</b> 22 AWG	<b>38.0±3.0</b> 1.500	3.8	815	1250	500	—	Figure 13A	Figure 13B
2944777721	2-2	2 x 2½	<b>0.65</b> 22 AWG	③	3.9	375	905	500	—	Figure 14A	Figure 14B

\*Bold numbers designate preferred parts.

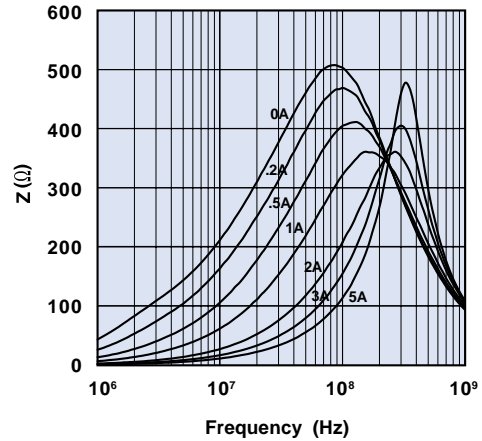
<sup>1</sup> Guaranteed Z Min is Z Typ -20%

③ Wire length of one winding is **38.0±3.0** (1.500). Wire length of second winding is **28.0± 3.0** (1.125)

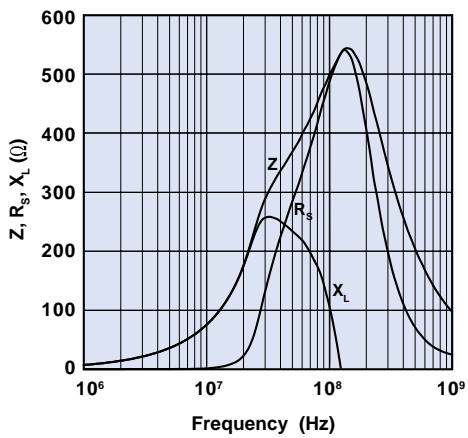
# Wound Beads



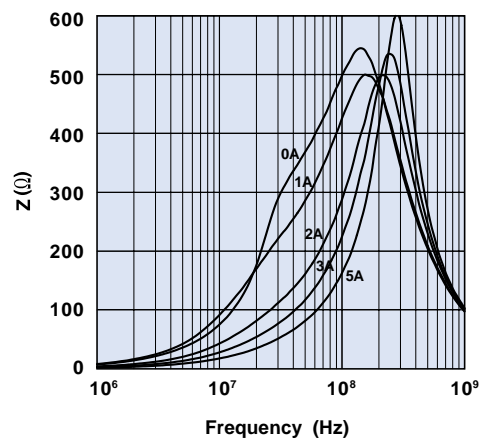
**Figure 3A** Impedance, reactance, and resistance vs. frequency for wound bead 2944666661.



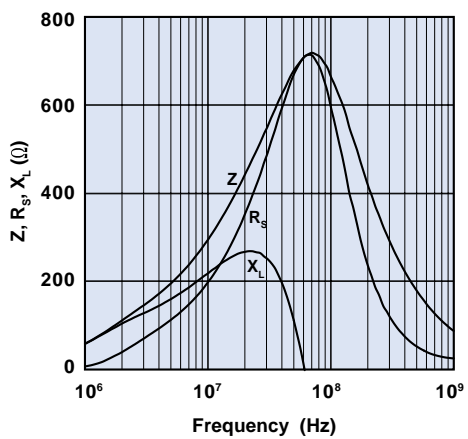
**Figure 3B** Impedance vs. frequency with dc bias as parameter for wound bead 2944666661.



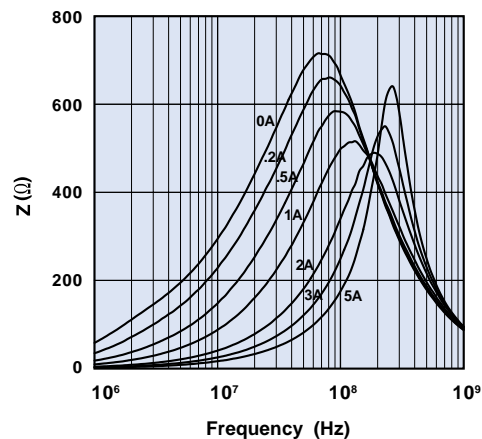
**Figure 4A** Impedance, reactance, and resistance vs. frequency for wound bead 2961666661.



**Figure 4B** Impedance vs. frequency with dc bias as parameter for wound bead 2961666661.



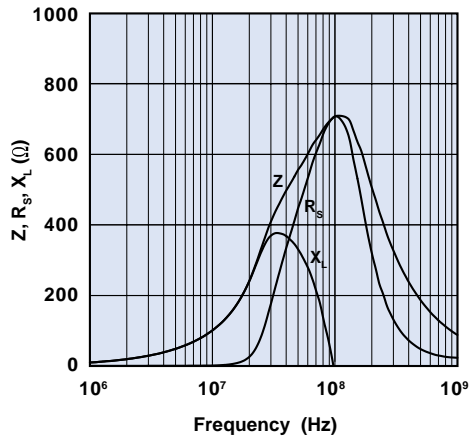
**Figure 5A** Impedance, reactance, and resistance vs. frequency for wound bead 2944666651.



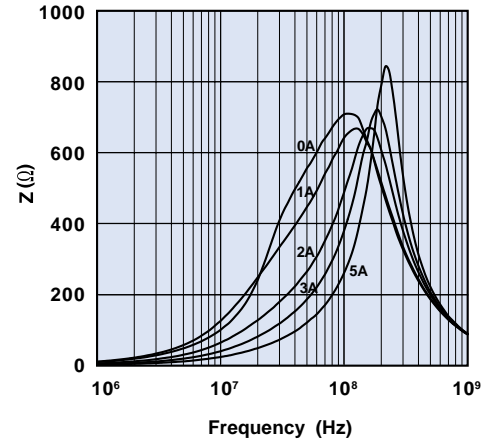
**Figure 5B** Impedance vs. frequency with dc bias as parameter for wound bead 2944666651.



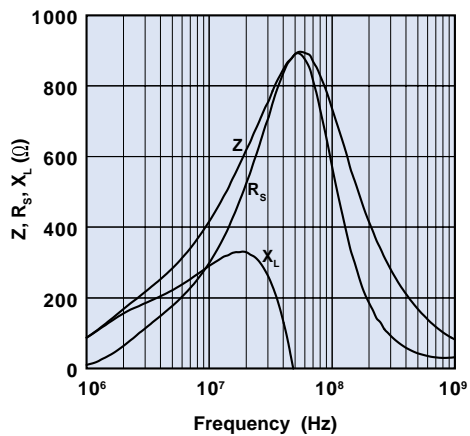
# Wound Beads



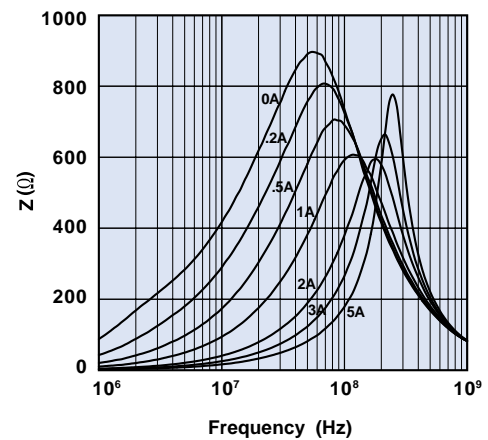
**Figure 6A** Impedance, reactance, and resistance vs. frequency for wound bead 2961666651.



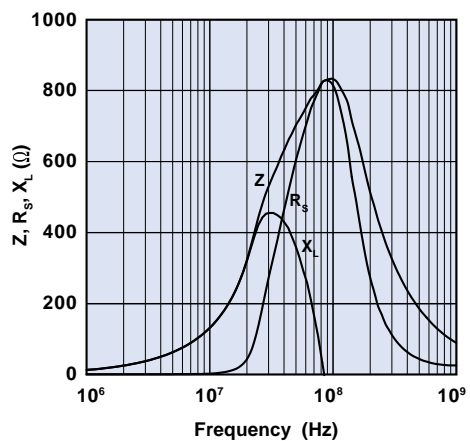
**Figure 6B** Impedance vs. frequency with dc bias as parameter for wound bead 2961666651.



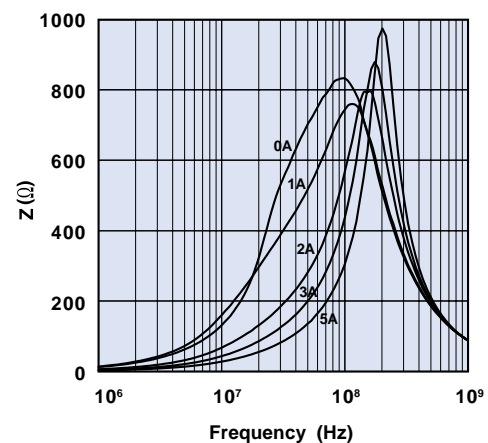
**Figure 7A** Impedance, reactance, and resistance vs. frequency for wound bead 2944666671.



**Figure 7B** Impedance vs. frequency with dc bias as parameter for wound bead 2944666671.

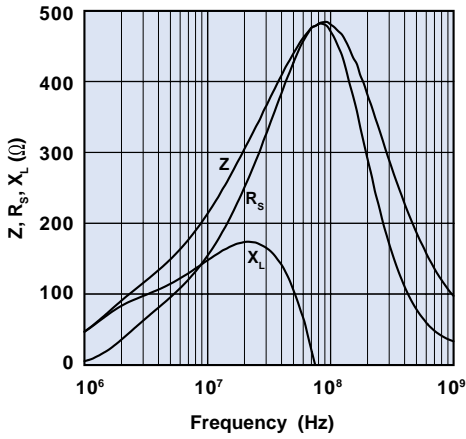


**Figure 8A** Impedance, reactance, and resistance vs. frequency for wound bead 2961666671.

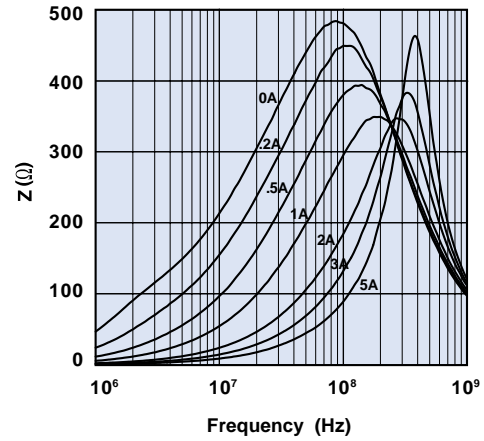


**Figure 8B** Impedance vs. frequency with dc bias as parameter for wound bead 2961666671.

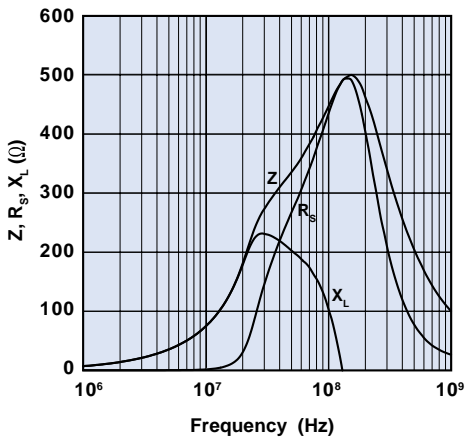
# Wound Beads



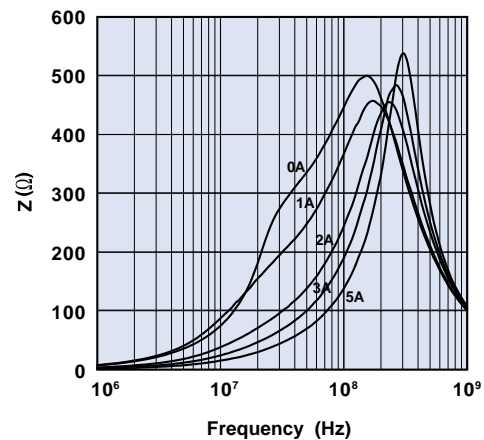
**Figure 9A** Impedance, reactance, and resistance vs. frequency for wound bead 2944666681.



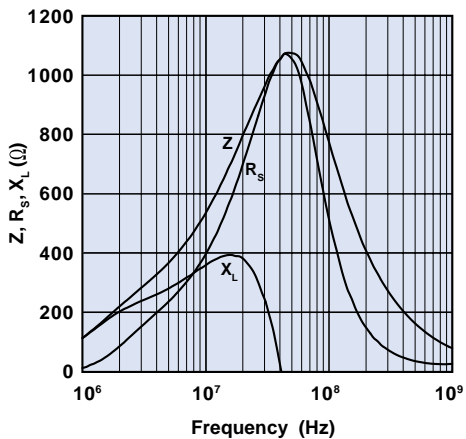
**Figure 9B** Impedance vs. frequency with dc bias as parameter for wound bead 2944666681.



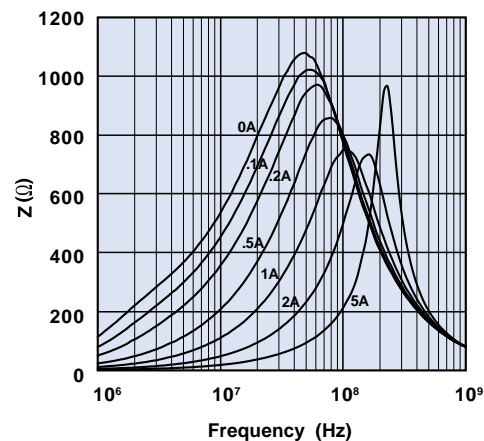
**Figure 10A** Impedance, reactance, and resistance vs. frequency for wound bead 2961666681.



**Figure 10B** Impedance vs. frequency with dc bias as parameter for wound bead 2961666681.

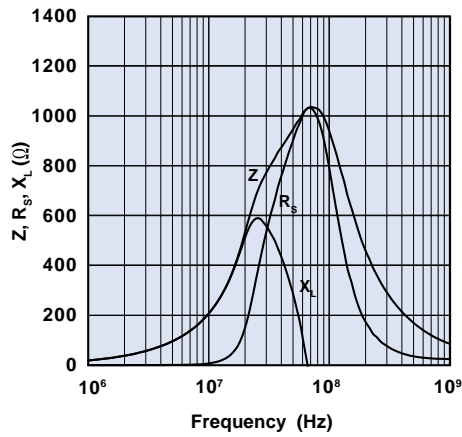


**Figure 11A** Impedance, reactance, and resistance vs. frequency for wound bead 2944666631.

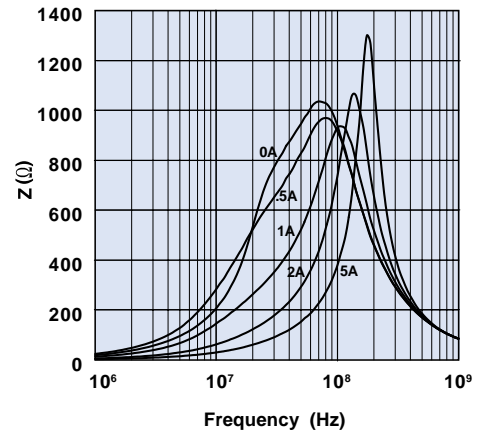


**Figure 11B** Impedance vs. frequency with dc bias as parameter for wound bead 2944666631.

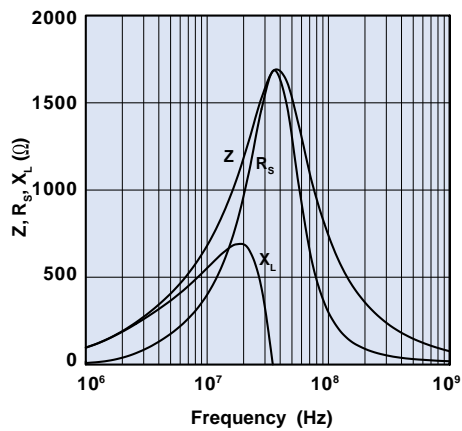
# Wound Beads



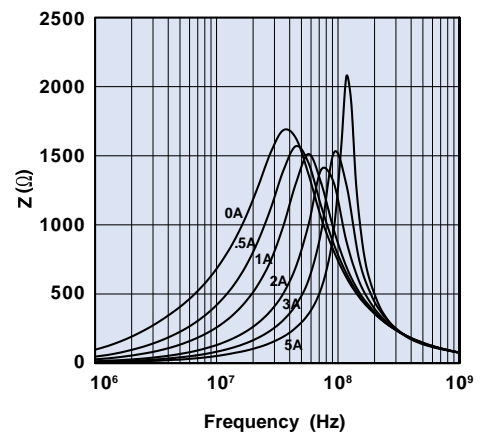
**Figure 12A** Impedance, reactance, and resistance vs. frequency for wound bead 2961666631.



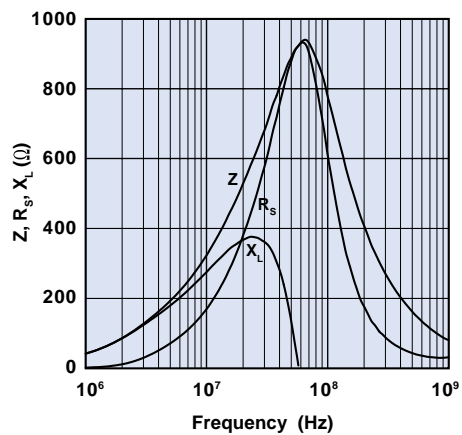
**Figure 12B** Impedance vs. frequency with dc bias as parameter for wound bead 2961666631.



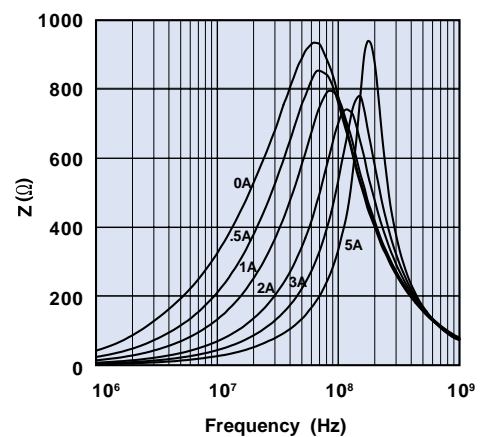
**Figure 13A** Impedance, reactance, and resistance vs. frequency for wound bead 2944777741.



**Figure 13B** Impedance vs. frequency with dc bias as parameter for wound bead 2944777741.



**Figure 14A** Impedance, reactance, and resistance vs. frequency for wound bead 2944777721.



**Figure 14B** Impedance vs. frequency with dc bias as parameter for wound bead 2944777721.

# Multi-Aperture Cores

Multi-aperture cores are used in balun (balance-unbalance) transformers and find wide application as broadband transformers in communication and CATV circuits. They are also employed in auto air bag circuits to guard against accidental activation.

- All multi-aperture cores are supplied burnished.
- For additional technical information on the use of these cores, see section "Use of Ferrites in Broadband Transformers" found on page 170.
- Multi-aperture cores are controlled for impedance limits only. They are tested for impedance with a single turn through two holes, using the Hewlett Packard HP 4193A Vector Impedance Meter.
- For impedance vs. frequency curves for these parts, see Figures 4-37.
- For any multi-aperture core requirement not listed in the catalog, please contact our customer service group for availability and pricing.

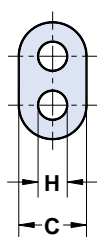


Figure 1

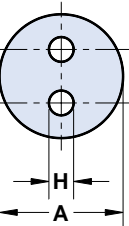
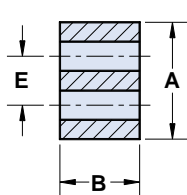


Figure 2

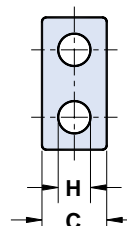
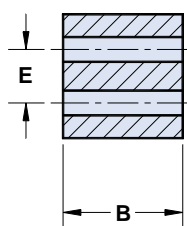


Figure 3

Dimensional letter designations have been changed from the 13th edition catalog and are now in accordance to the MMPA SFG-96.

Dimensions (Bold numbers are in millimeters, light numbers are nominal in inches.)

Part Number**	Fig.	A	B*	C	E	H	Wt (g)	Typical Impedance(Ω) <sup>1</sup>		Z, R <sub>s</sub> , X <sub>L</sub> vs. Frequency Curve
								25 MHz	100 MHz	
<b>2873002302</b>	1	<b>3.45±0.25</b> .136	<b>2.35±0.25</b> .093	<b>2.0±0.15</b> .079	<b>1.45±0.1</b> .057	<b>0.75±0.25</b> .034	.1	44	—	Figure 4
<b>2843002302</b>	1	<b>3.45±0.25</b> .136	<b>2.35±0.25</b> .093	<b>2.0±0.15</b> .079	<b>1.45±0.1</b> .057	<b>0.75±0.25</b> .034	.1	—	44	Figure 5
<b>2861002302</b>	1	<b>3.45±0.25</b> .136	<b>2.35±0.25</b> .093	<b>2.0±0.15</b> .079	<b>1.45±0.1</b> .057	<b>0.75±0.25</b> .034	.1	—	38	Figure 6
<b>2873002702</b>	1	<b>7.0±0.25</b> .276	<b>3.1±0.25</b> .122	<b>4.2 - 0.25</b> .160	<b>2.9±0.1</b> .114	<b>1.7+ 0.2</b> .071	.3	38	—	Figure 7
<b>2843002702</b>	1	<b>7.0±0.25</b> .276	<b>3.1±0.25</b> .122	<b>4.2 - 0.25</b> .160	<b>2.9±0.1</b> .114	<b>1.7+ 0.2</b> .071	.3	—	50	Figure 8
<b>2861002702</b>	1	<b>7.0±0.25</b> .276	<b>3.1±0.25</b> .122	<b>4.2 - 0.25</b> .160	<b>2.9±0.1</b> .114	<b>1.7+ 0.2</b> .071	.3	—	44	Figure 9
<b>2873002402</b>	1	<b>7.0±0.25</b> .276	<b>6.2±0.25</b> .244	<b>4.2 - 0.25</b> .160	<b>2.9±0.1</b> .114	<b>1.7+ 0.2</b> .071	.5	75	—	Figure 10
<b>2843002402</b>	1	<b>7.0±0.25</b> .276	<b>6.2±0.25</b> .244	<b>4.2 - 0.25</b> .160	<b>2.9±0.1</b> .114	<b>1.7+ 0.2</b> .071	.5	—	100	Figure 11
<b>2861002402</b>	1	<b>7.0±0.25</b> .276	<b>6.2±0.25</b> .244	<b>4.2 - 0.25</b> .160	<b>2.9±0.1</b> .114	<b>1.7+ 0.2</b> .071	.5	—	88	Figure 12
<b>2873001802</b>	2	<b>6.35±0.25</b> .250	<b>6.15±0.25</b> .242	—	<b>2.75±0.2</b> .108	<b>1.1 + 0.3</b> .050	.8	106	—	Figure 13
<b>2843001802</b>	2	<b>6.35±0.25</b> .250	<b>6.15±0.25</b> .242	—	<b>2.75±0.2</b> .108	<b>1.1 + 0.3</b> .050	.8	—	131	Figure 14

\* This dimension may be modified to suit specific applications.

\*\* Bold part numbers designate preferred parts.

<sup>1</sup> Guaranteed Z Min is Z Typ -20%

**Fair-Rite Products Corp.** P.O. Box J, One Commercial Row, Wallkill, NY 12589-0288

Phone: (888) FAIR RITE / (845) 895-2055 • FAX: (888) FERRITE / (845) 895-2629 • www.fair-rite.com • E-Mail: ferrites@fair-rite.com  
(888) 324-7748 (888) 337-7483 Note: (914) Area Code has changed to (845).

# Multi-Aperture Cores

Dimensions (Bold numbers are in millimeters, light numbers are nominal in inches.)

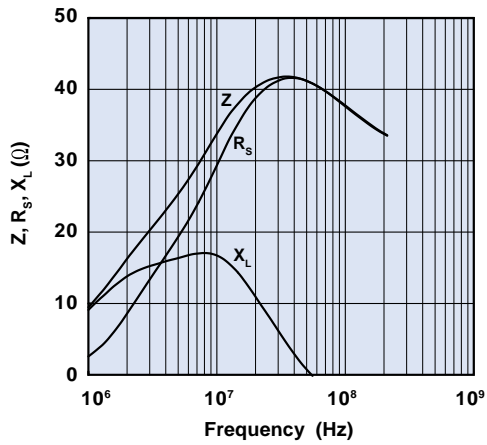
Part Number**	Fig.	A	B*	C	E	H	Wt (g)	Typical Impedance( $\Omega$ ) <sup>1</sup>		Z, R <sub>s</sub> , X <sub>L</sub> vs. Frequency Curve
								25 MHz	100 MHz	
2861001802	2	<b>6.35±0.25</b> .250	<b>6.15±0.25</b> .242	–	<b>2.75±0.2</b> .108	<b>1.1 + 0.3</b> .050	.8	–	119	Figure 15
2873001702	2	<b>6.35±0.25</b> .250	<b>12.0±0.35</b> .471	–	<b>2.75±0.2</b> .108	<b>1.1 + 0.3</b> .050	1.6	200	–	Figure 16
2843001702	2	<b>6.35±0.25</b> .250	<b>12.0±0.35</b> .471	–	<b>2.75±0.2</b> .108	<b>1.1 + 0.3</b> .050	1.6	–	256	Figure 17
2861001702	2	<b>6.35±0.25</b> .250	<b>12.0±0.35</b> .471	–	<b>2.75±0.2</b> .108	<b>1.1 + 0.3</b> .050	1.6	–	230	Figure 18
2873001502	1	<b>13.3±0.6</b> .525	<b>6.6±0.25</b> .260	<b>7.5±0.35</b> .295	<b>5.7±0.25</b> .225	<b>3.8±0.25</b> .150	1.7	50	–	Figure 19
2843001502	1	<b>13.3±0.6</b> .525	<b>6.6±0.25</b> .260	<b>7.5±0.35</b> .295	<b>5.7±0.25</b> .225	<b>3.8±0.25</b> .150	1.7	–	88	Figure 20
2861001502	1	<b>13.3±0.6</b> .525	<b>6.6±0.25</b> .260	<b>7.5±0.35</b> .295	<b>5.7±0.25</b> .225	<b>3.8±0.25</b> .150	1.7	–	69	Figure 21
2873000302	1	<b>13.3±0.6</b> .525	<b>10.3±0.3</b> .407	<b>7.5±0.35</b> .295	<b>5.7±0.25</b> .225	<b>3.8±0.25</b> .150	2.6	75	–	Figure 22
2843000302	1	<b>13.3±0.6</b> .525	<b>10.3±0.3</b> .407	<b>7.5±0.35</b> .295	<b>5.7±0.25</b> .225	<b>3.8±0.25</b> .150	2.6	–	130	Figure 23
2861000302	1	<b>13.3±0.6</b> .525	<b>10.3±0.3</b> .407	<b>7.5±0.35</b> .295	<b>5.7±0.25</b> .225	<b>3.8±0.25</b> .150	2.6	–	106	Figure 24
2873000102	1	<b>13.3±0.6</b> .525	<b>13.4±0.3</b> .528	<b>7.5±0.35</b> .295	<b>5.7±0.25</b> .225	<b>3.8±0.25</b> .150	3.5	94	–	Figure 25
2843000102	1	<b>13.3±0.6</b> .525	<b>13.4±0.3</b> .528	<b>7.5±0.35</b> .295	<b>5.7±0.25</b> .225	<b>3.8±0.25</b> .150	3.5	–	175	Figure 26
2861000102	1	<b>13.3±0.6</b> .525	<b>13.4±0.3</b> .528	<b>7.5±0.35</b> .295	<b>5.7±0.25</b> .225	<b>3.8±0.25</b> .150	3.5	–	138	Figure 27
2873000202	1	<b>13.3±0.6</b> .525	<b>14.35±0.5</b> .565	<b>7.5±0.35</b> .295	<b>5.7±0.25</b> .225	<b>3.8±0.25</b> .150	3.7	106	–	Figure 28
2843000202	1	<b>13.3±0.6</b> .525	<b>14.35±0.5</b> .565	<b>7.5±0.35</b> .295	<b>5.7±0.25</b> .225	<b>3.8±0.25</b> .150	3.7	–	180	Figure 29
2861000202	1	<b>13.3±0.6</b> .525	<b>14.35±0.5</b> .565	<b>7.5±0.35</b> .295	<b>5.7±0.25</b> .225	<b>3.8±0.25</b> .150	3.7	–	150	Figure 30
2873006802	1	<b>13.3±0.6</b> .525	<b>27.0±0.75</b> 1.062	<b>7.5±0.35</b> .295	<b>5.7±0.25</b> .225	<b>3.8±0.25</b> .150	7.0	180	–	Figure 31
2843006802	1	<b>13.3±0.6</b> .525	<b>27.0±0.75</b> 1.062	<b>7.5±0.35</b> .295	<b>5.7±0.25</b> .225	<b>3.8±0.25</b> .150	7.0	–	300	Figure 32
2861006802	1	<b>13.3±0.6</b> .525	<b>27.0±0.75</b> 1.062	<b>7.5±0.35</b> .295	<b>5.7±0.25</b> .225	<b>3.8±0.25</b> .150	7.0	–	280	Figure 33
2843010402	3	<b>19.45±0.4</b> .765	<b>12.7±0.5</b> .500	<b>9.5±0.25</b> .375	<b>9.9±0.25</b> .390	<b>4.75±0.2</b> .187	7.5	–	200	Figure 34
2843010302	3	<b>19.45±0.4</b> .765	<b>25.4±0.7</b> 1.000	<b>9.5±0.25</b> .375	<b>9.9±0.25</b> .390	<b>4.75±0.2</b> .187	18	–	400	Figure 35
2843009902	3	<b>28.7±0.6</b> 1.130	<b>28.7±0.7</b> 1.130	<b>14.25±0.3</b> .560	<b>14.0±0.3</b> .550	<b>6.35±0.15</b> .250	48	–	500	Figure 36
2861010002	3	<b>30.2±0.6</b> 1.190	<b>28.7±0.7</b> 1.130	<b>15.0±0.4</b> .590	<b>14.6±0.4</b> .575	<b>6.8±0.2</b> .268	46	–	600	Figure 37

\* This dimension may be modified to suit specific applications.

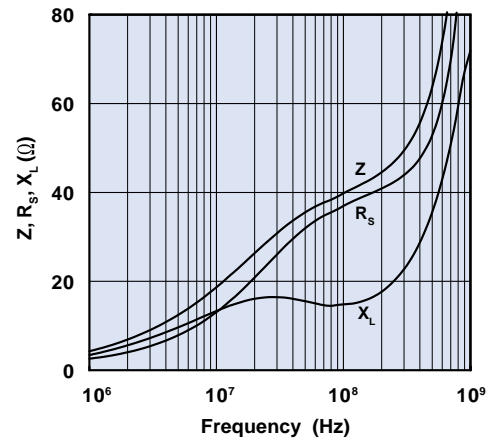
\*\* Bold part numbers designate preferred parts.

<sup>1</sup>Guaranteed Z Min is Z Typ -20%

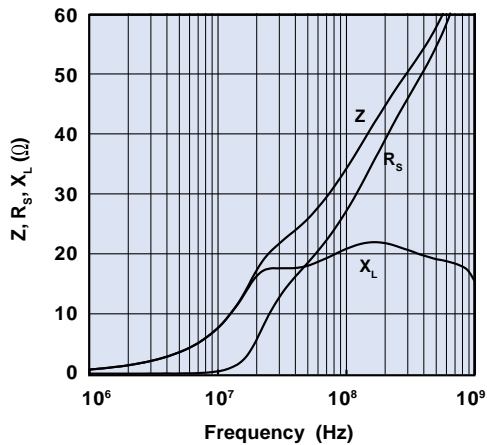
# Multi-Aperture Cores



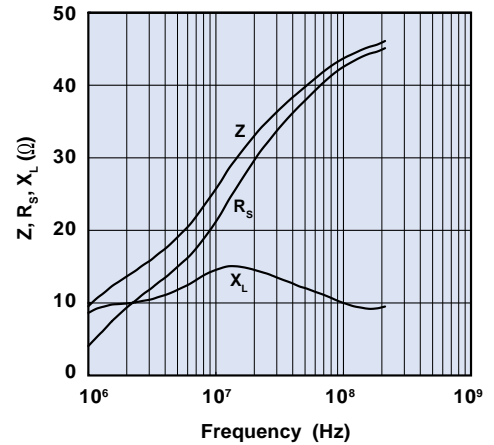
**Figure 4** Impedance, reactance, and resistance vs. frequency curve for multi-aperture core 2873002302.



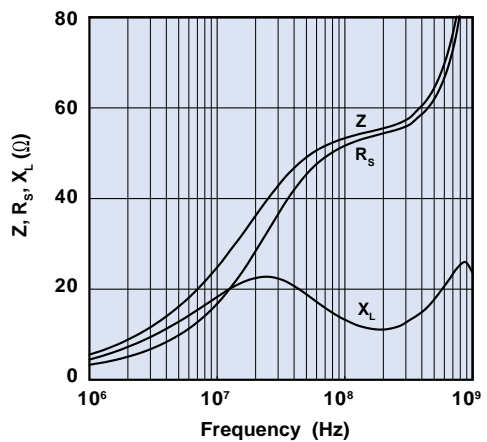
**Figure 5** Impedance, reactance, and resistance vs. frequency curve for multi-aperture core 2843002302.



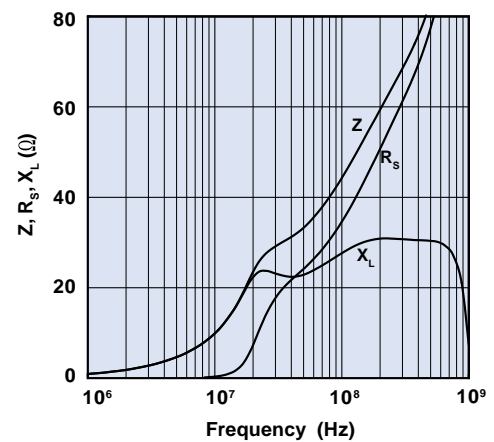
**Figure 6** Impedance, reactance, and resistance vs. frequency curve for multi-aperture core 2861002302.



**Figure 7** Impedance, reactance, and resistance vs. frequency curve for multi-aperture core 2873002702.

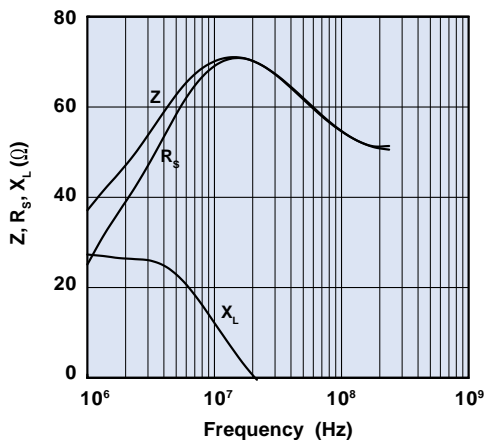


**Figure 8** Impedance, reactance, and resistance vs. frequency curve for multi-aperture core 2843002702.

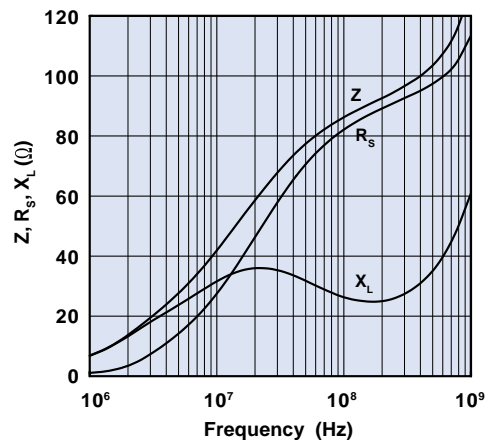


**Figure 9** Impedance, reactance, and resistance vs. frequency curve for multi-aperture core 2861002702.

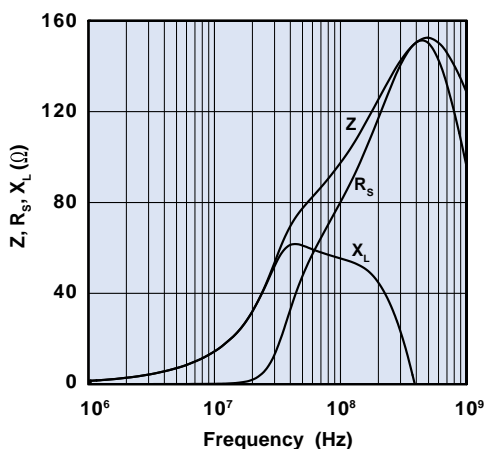
# Multi-Aperture Cores



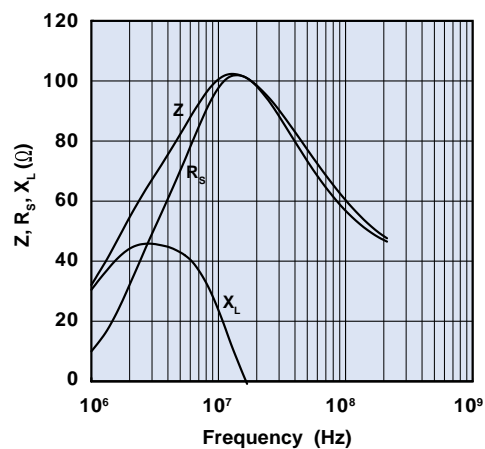
**Figure 10** Impedance, reactance, and resistance vs. frequency curve for multi-aperture core 2873002402.



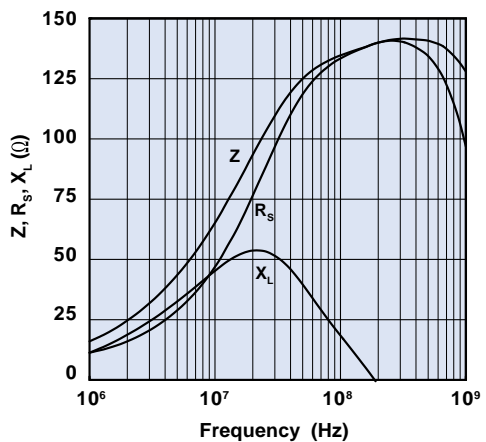
**Figure 11** Impedance, reactance, and resistance vs. frequency curve for multi-aperture core 2843002402.



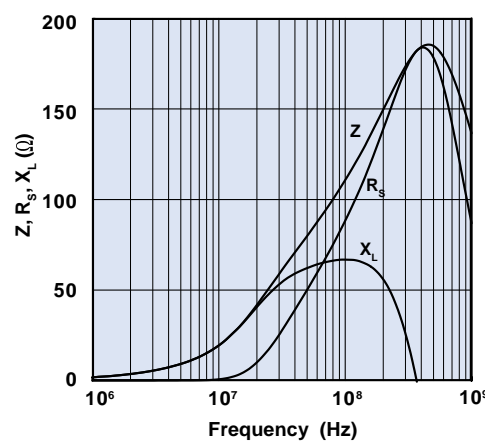
**Figure 12** Impedance, reactance, and resistance vs. frequency curve for multi-aperture core 2861002402.



**Figure 13** Impedance, reactance, and resistance vs. frequency curve for multi-aperture core 2873001802.

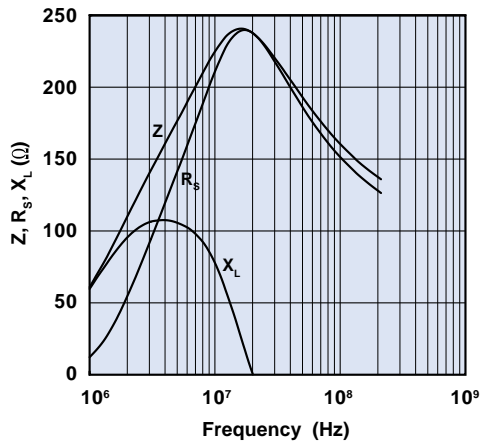


**Figure 14** Impedance, reactance, and resistance vs. frequency curve for multi-aperture core 2843001802.

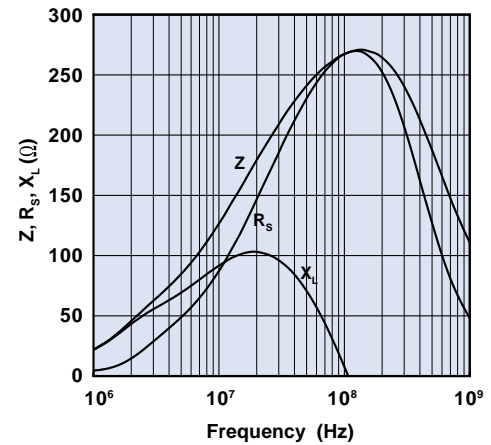


**Figure 15** Impedance, reactance, and resistance vs. frequency curve for multi-aperture core 2861001802.

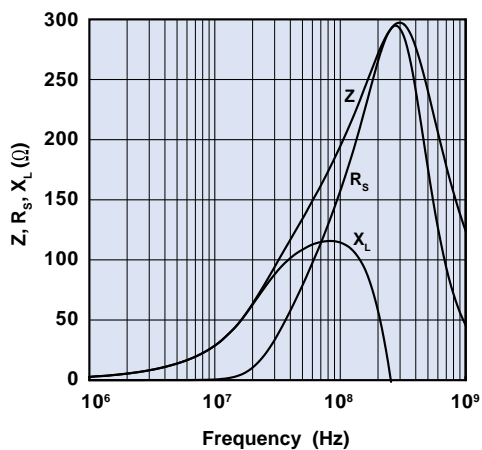
# Multi-Aperture Cores



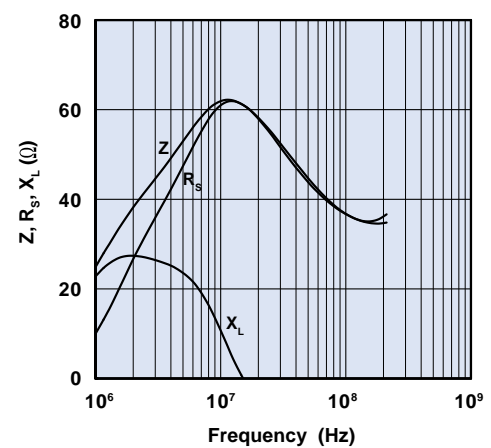
**Figure 16** Impedance, reactance, and resistance vs. frequency curve for multi-aperture core 2873001702.



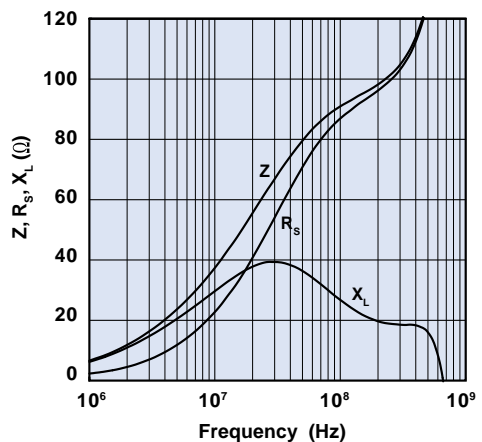
**Figure 17** Impedance, reactance, and resistance vs. frequency curve for multi-aperture core 2843001702.



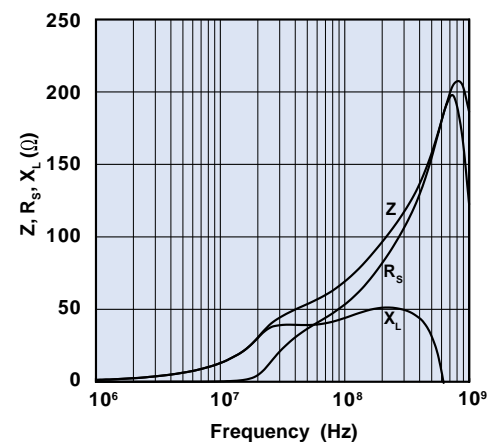
**Figure 18** Impedance, reactance, and resistance vs. frequency curve for multi-aperture core 2861001702.



**Figure 19** Impedance, reactance, and resistance vs. frequency curve for multi-aperture core 2873001502.



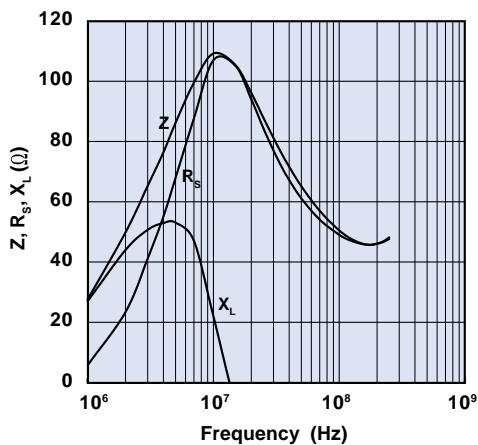
**Figure 20** Impedance, reactance, and resistance vs. frequency curve for multi-aperture core 2843001502.



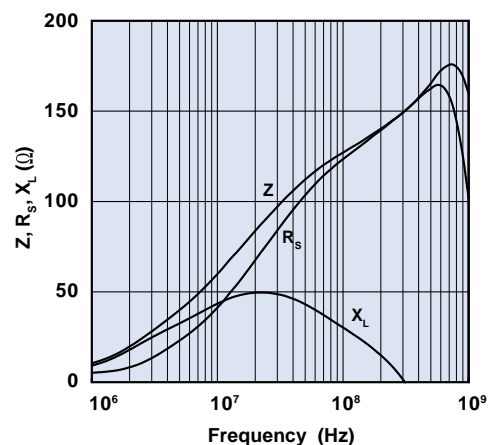
**Figure 21** Impedance, reactance, and resistance vs. frequency curve for multi-aperture core 2861001502.



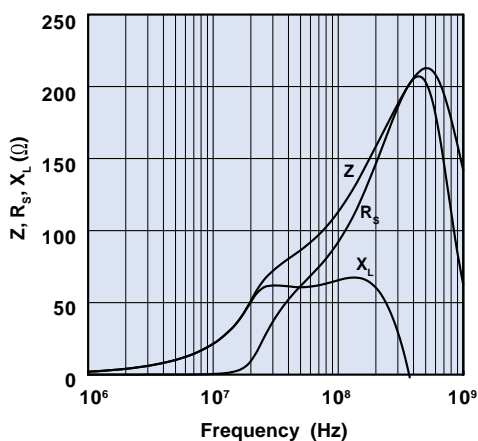
# Multi-Aperture Cores



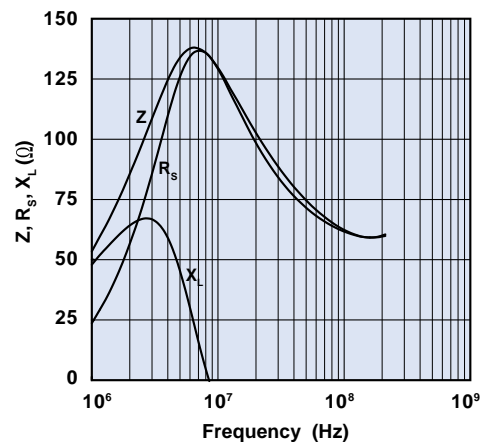
**Figure 22** Impedance, reactance, and resistance vs. frequency curve for multi-aperture core 2873000302.



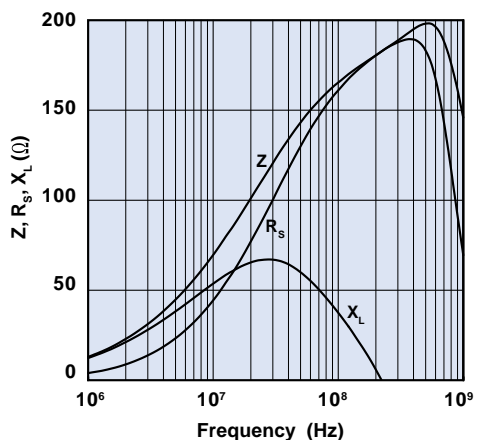
**Figure 23** Impedance, reactance, and resistance vs. frequency curve for multi-aperture core 2843000302.



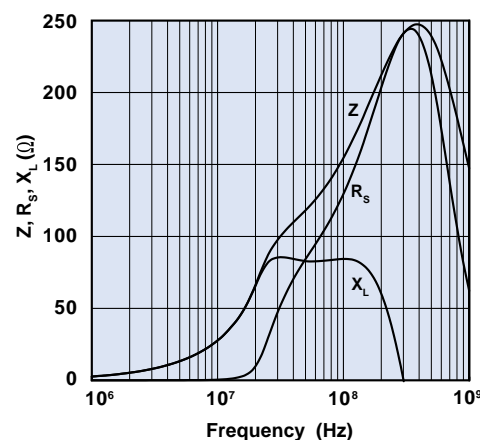
**Figure 24** Impedance, reactance, and resistance vs. frequency curve for multi-aperture core 2861000302.



**Figure 25** Impedance, reactance, and resistance vs. frequency curve for multi-aperture core 2873000102.

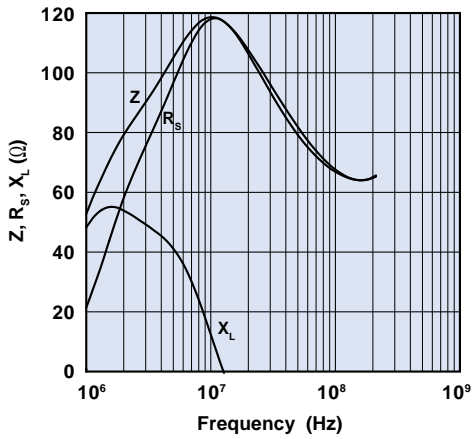


**Figure 26** Impedance, reactance, and resistance vs. frequency curve for multi-aperture core 2843000102.

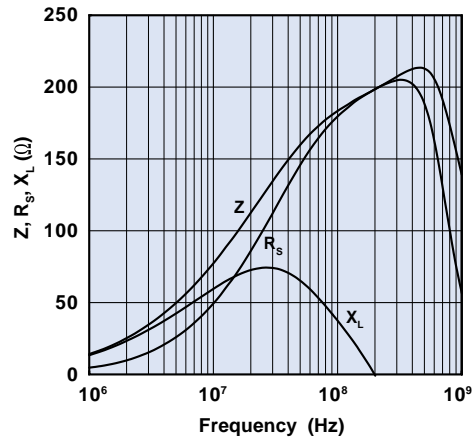


**Figure 27** Impedance, reactance, and resistance vs. frequency curve for multi-aperture core 2861000102.

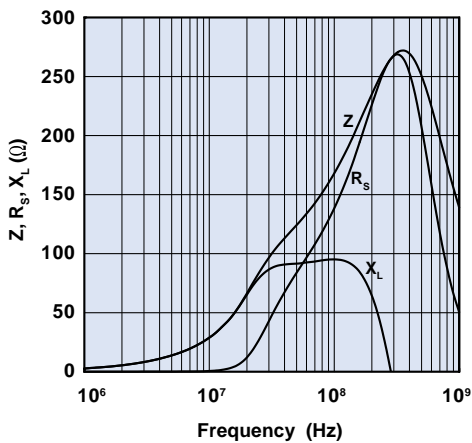
# Multi-Aperture Cores



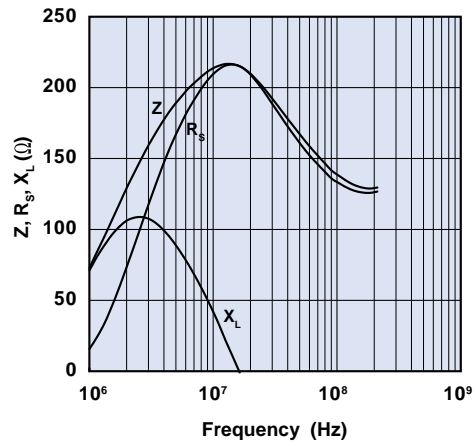
**Figure 28** Impedance, reactance, and resistance vs. frequency curve for multi-aperture core 2873000202.



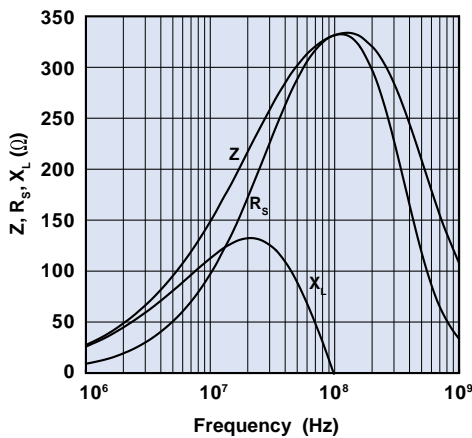
**Figure 29** Impedance, reactance, and resistance vs. frequency curve for multi-aperture core 2843000202.



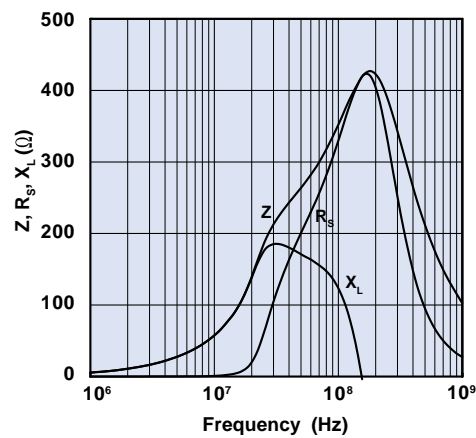
**Figure 30** Impedance, reactance, and resistance vs. frequency curve for multi-aperture core 2861000202.



**Figure 31** Impedance, reactance, and resistance vs. frequency curve for multi-aperture core 2873006802.

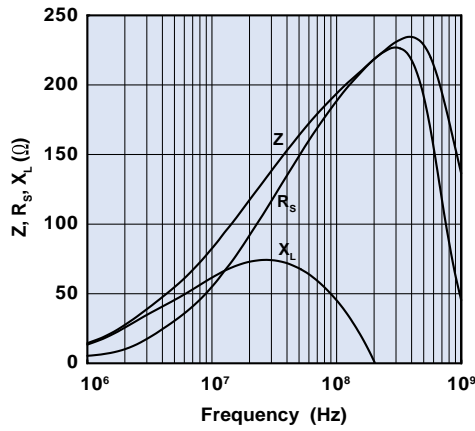


**Figure 32** Impedance, reactance, and resistance vs. frequency curve for multi-aperture core 2843006802.

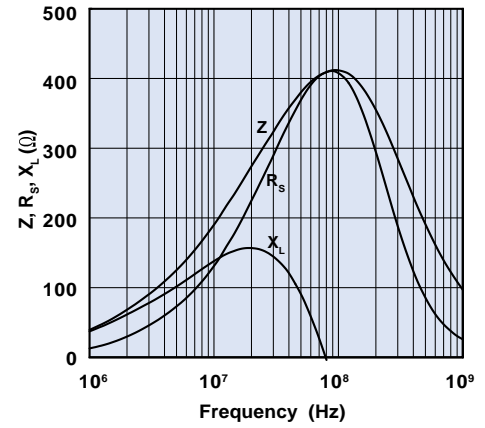


**Figure 33** Impedance, reactance, and resistance vs. frequency curve for multi-aperture core 2861006802.

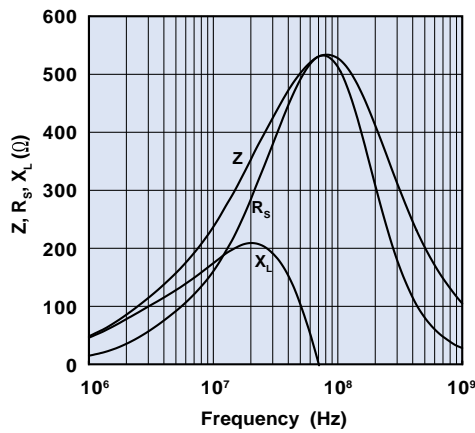
# Multi-Aperture Cores



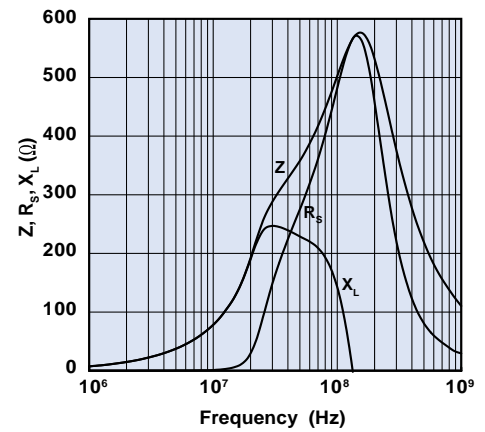
**Figure 34** Impedance, reactance, and resistance vs. frequency curve for multi-aperture core 2843010402.



**Figure 35** Impedance, reactance, and resistance vs. frequency curve for multi-aperture core 2843010302.



**Figure 36** Impedance, reactance, and resistance vs. frequency curve for multi-aperture core 2843009902.



**Figure 37** Impedance, reactance, and resistance vs. frequency curve for multi-aperture core 2861010002.

# Engineering Evaluation Kits

## Expanded Cable and Connector EMI Suppressor Kit

*Part Number 0199000005*

This is our most popular engineering kit. As the name implies, this kit provides a broad sampling of suppression cores, specifically designed to attenuate EMI between all types of cable connected systems. To assemble the split cable suppression cores, polypropylene cases and steel clips are included in this kit.

## Snap-It Cable Suppressor Kit

*Part Number 0199000017*

This kit contains six sets of round cable snap-its in two of our materials; the high resistivity NiZn 44 material and the new recently introduced MnZn 31 material. Either material in these round cable snap-its can be used to suppress frequencies up to 500 MHz.

The round cable snap-its can accommodate round cables with diameters from .160 to .750 inches

## Chip Bead Kit

*Part Number 0199000018*

This kit contains 20 different chip bead parts in four different EIA standard package sizes. This kit contains low current, medium current, as well as high current chip beads. Also included in this kit are a selection of standard and high signal speed parts.

## EMI Suppression Bead Kit

*Part Number 0199000019*

This kit contains 20 different EMI suppression beads in two different materials; 73 and 43 material. The beads range from a hole diameter of 0.85mm up to 5.0 mm.

## Connector Plate Kit

*Part Number 0199000020*

This kit contains 20 different suppression plates in high resistivity NiZn 44 material.

## RFID Kit

*Part Number 0199000024*

This Kit contains 10 different sizes in materials 78 (for 125 kHz) & 61 (for 13.56 MHz) and is specifically designed for use in transponders in Radio Frequency identification Devices.



## Surface Mount Kit

*Part Number 0199000025*

This Bookshelf kit contains a combination of 20 differential and common-mode surface mount beads. Supplied in several sizes and four Fair-Rite materials (73, 43, 44, 61), these beads attenuate conducted EMI from 1 MHz into the GHz frequencies. These SM beads have lower dc resistances and higher current carrying capacities than plated beads.

## Wound Bead Kit

*Part Number 0199000027*

Contains an assortment of 6 and 11 hole beads, wound in several configurations. These beads in Fair-Rite's 44 and 61 materials, provide an impedance of hundreds of ohm over a 5 to 800 MHz frequency range, with or without a dc bias current of up to 5 ampere.

## Bead-On-Lead EMI Suppressor Kit

*Part Number 0199000028*

Three popular core sizes in materials 43, 61 & 73 are included in this evaluation kit.

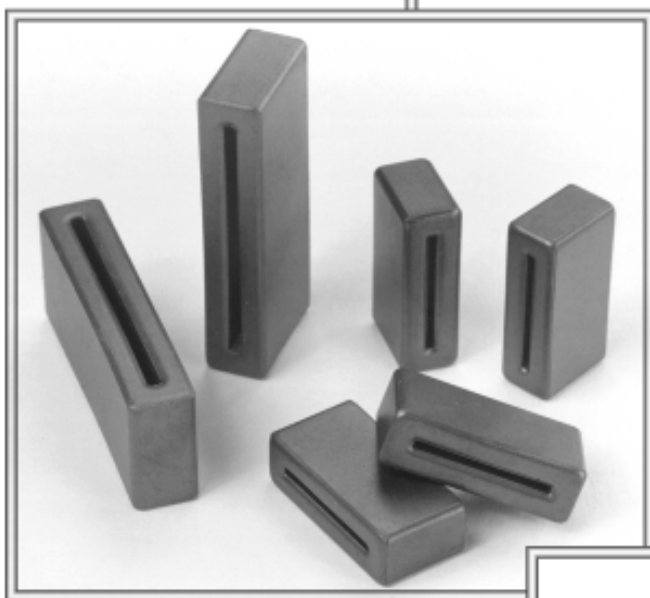
These nine Fair-Rite engineering evaluation kits are available from Fair-Rite in Wallkill, NY. They can also be purchased from our distributors.

Please refer to our web site at [www.fair-rite.com](http://www.fair-rite.com) for a complete list of our distributors.

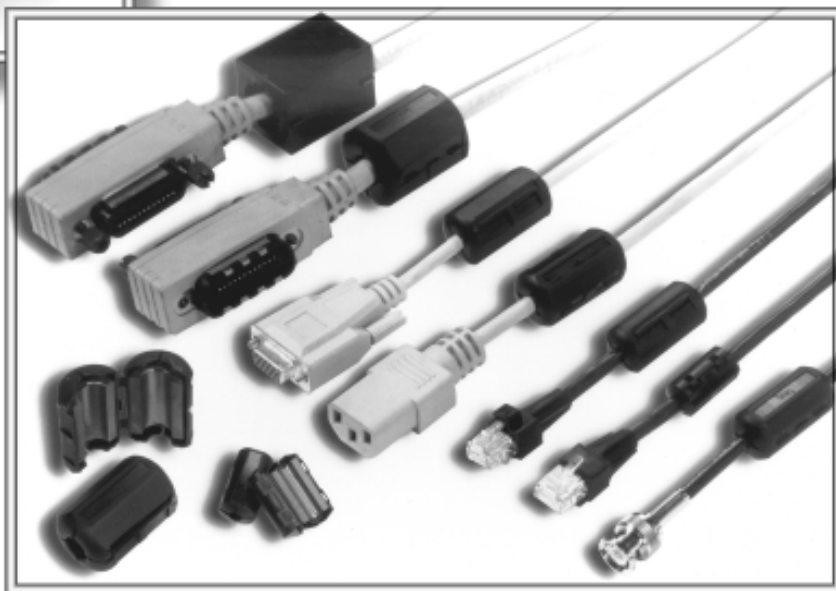
**Fair-Rite Products Corp.**

P.O. Box J, One Commercial Row, Wallkill, NY 12589-0288

Phone: (888) FAIR RITE / (845) 895-2055 • FAX: (888) FERRITE / (845) 895-2629 • [www.fair-rite.com](http://www.fair-rite.com) • E-Mail: [ferrites@fair-rite.com](mailto:ferrites@fair-rite.com)  
(888) 324-7748 (888) 337-7483 **Note: (914) Area Code has changed to (845).**



# Cable Components



P.O. Box J, One Commercial Row, Wallkill, NY 12589-0288

Fair-Rite Products Corp.

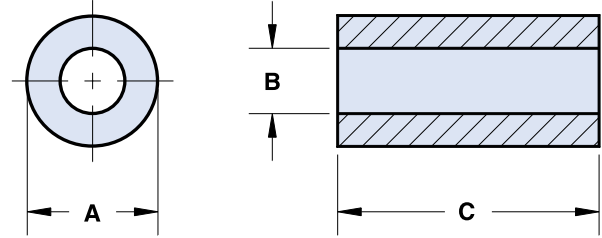
Phone: (888) FAIR RITE / (845) 895-2055 • FAX: (888) FERRITE / (845) 895-2629 • www.fair-rite.com • E-Mail: ferrites@fair-rite.com  
(888) 324-7748 (888) 337-7483 Note: (914) Area Code has changed to (845).

# Round Cable EMI Suppression Cores

Listed in ascending order of "B" dimension.

Fair-Rite offers a broad selection of round cable EMI suppression cores with guaranteed impedance specifications over a wide frequency range.

- The "H" column gives for each core size the calculated dc bias field in oersted for 1 turn and 1 ampere direct current. The actual dc H field in the application is this value of H times the actual NI (ampere - turn) product. For the effect of the dc bias on the impedance of the core material, see the graphs on pages 179-180, Figures 16-20.



- For typical impedance vs. frequency curves, see Figures 1-5.
- Round cable EMI suppression cores are controlled for impedance limits only. They are tested for impedance with a single turn, using the Hewlett Packard HP 4193A Vector Impedance Meter for beads in 31 and 43 material and the HP 4191A RF Impedance Analyzer for 61 material beads.
- For smaller size cores, please refer to our EMI Suppression Beads section found on page 24 of this catalog.
- For any round cable EMI suppression core requirement not listed in the catalog, please contact our customer service group for availability and pricing.
- The Expanded Cable and Connector EMI Suppression Kit (part number 0199000005) contains a selection of these suppression cores. (See page 92).

Dimensions (Bold numbers are in millimeters, light numbers are nominal in inches.)

Typical Impedance( $\Omega$ )<sup>1</sup>

Part Number**	A	B	C*	Wt (g)	H (Oe)	10 MHz	25 MHz	100 MHz	250 MHz
2631480102	<b>12.3±0.4</b> .485	<b>4.95±0.25</b> .200	<b>12.7±0.4</b> .500	4.8	.52	58	88	140	-
2643480102	<b>12.3±0.4</b> .485	<b>4.95±0.25</b> .200	<b>12.7±0.4</b> .500	4.8	.52	-	84	121	-
2631480002	<b>12.3±0.4</b> .485	<b>4.95±0.25</b> .200	<b>25.4±0.75</b> 1.000	9.5	.52	115	175	295	-
2643480002	<b>12.3±0.4</b> .485	<b>4.95±0.25</b> .200	<b>25.4±0.75</b> 1.000	9.5	.52	-	165	236	-
2643540702	<b>14.3±0.45</b> .562	<b>6.35±0.25</b> .250	<b>5.3 - 0.45</b> .200	2.6	.43	-	30	50	-
2643540102	<b>14.3±0.45</b> .562	<b>6.35±0.25</b> .250	<b>10.15±0.4</b> .400	5.1	.43	-	61	89	-
<b>2631540202</b>	<b>14.3±0.45</b> .562	<b>6.35±0.25</b> .250	<b>13.8 - 0.7</b> .530	6.8	.43	58	88	140	-
<b>2643540202</b>	<b>14.3±0.45</b> .562	<b>6.35±0.25</b> .250	<b>13.8 - 0.7</b> .530	6.8	.43	-	78	118	-
<b>2661540202</b>	<b>14.3±0.45</b> .562	<b>6.35±0.25</b> .250	<b>13.8 - 0.7</b> .530	6.8	.43	-	-	125	180
<b>2631540002</b>	<b>14.3±0.45</b> .562	<b>6.35±0.25</b> .250	<b>28.6±0.75</b> 1.125	14	.43	119	181	300	-
<b>2643540002</b>	<b>14.3±0.45</b> .562	<b>6.35±0.25</b> .250	<b>28.6±0.75</b> 1.125	14	.43	-	171	250	-

\*\*Bold part numbers designate preferred parts.

<sup>1</sup>Guaranteed Z Min is Z Typ -20%

\*This dimension may be modified to suit specific applications.

**Fair-Rite Products Corp.** P.O. Box J, One Commercial Row, Wallkill, NY 12589-0288

Phone: (888) FAIR RITE / (845) 895-2055 • FAX: (888) FERRITE / (845) 895-2629 • www.fair-rite.com • E-Mail: ferrites@fair-rite.com  
(888) 324-7748 (888) 337-7483 Note: (914) Area Code has changed to (845).

# Round Cable EMI Suppression Cores

Listed in ascending order of "B" dimension.

Dimensions (Bold numbers are in millimeters, light numbers are nominal in inches.)

Typical Impedance( $\Omega$ )<sup>1</sup>

Part Number**	A	B	C*	Wt (g)	H (Oe)	10 MHz	25 MHz	100 MHz	250 MHz
<b>2661540002</b>	<b>14.3±0.45</b> .562	<b>6.35±0.25</b> .250	<b>28.6±0.75</b> 1.125	14	.43	-	-	250	310
2643540302	<b>14.3±0.45</b> .562	<b>7.1±0.25</b> .280	<b>15.25±0.4</b> .600	7.5	.41	-	75	118	-
2643800302	<b>12.7±0.25</b> .500	<b>7.15±0.2</b> .282	<b>4.9 - 0.25</b> .188	1.7	.43	-	26	42	-
<b>2643540402</b>	<b>14.3±0.45</b> .562	<b>7.25±0.15</b> .286	<b>28.6±0.75</b> 1.125	14	.40	-	143	215	-
2643801102	<b>12.7±0.25</b> .500	<b>7.9±0.2</b> .312	<b>6.35±0.2</b> .250	2.1	.40	-	26	41	-
2643801902	<b>12.7±0.25</b> .500	<b>7.9±0.2</b> .312	<b>12.7±0.4</b> .500	4.3	.40	-	44	73	-
<b>2631625002</b>	<b>16.25 - 0.75</b> .625	<b>7.9±0.25</b> .312	<b>14.3±0.35</b> .562	8.7	.36	53	75	130	-
<b>2643625002</b>	<b>16.25 - 0.75</b> .625	<b>7.9±0.25</b> .312	<b>14.3±0.35</b> .562	8.7	.36	-	70	113	-
<b>2631625102</b>	<b>16.25 - 0.75</b> .625	<b>7.9±0.25</b> .312	<b>28.6±0.75</b> 1.125	17	.36	103	156	260	-
<b>2643625102</b>	<b>16.25 - 0.75</b> .625	<b>7.9±0.25</b> .312	<b>28.6±0.75</b> 1.125	17	.36	-	130	213	-
2643625202	<b>16.25 - 0.75</b> .625	<b>7.9±0.25</b> .312	<b>50.8±1.0</b> 2.000	31	.36	-	235	384	-
2643665902	<b>17.45±0.4</b> .687	<b>9.5±0.25</b> .375	<b>6.35±0.25</b> .250	4.5	.32	-	26	44	-
<b>2643665802</b>	<b>17.45±0.4</b> .687	<b>9.5±0.25</b> .375	<b>12.7±0.5</b> .500	9.0	.32	-	55	88	-
<b>2631665702</b>	<b>17.45±0.4</b> .687	<b>9.5±0.25</b> .375	<b>28.6±0.75</b> 1.125	20	.32	89	138	225	-
<b>2643665702</b>	<b>17.45±0.4</b> .687	<b>9.5±0.25</b> .375	<b>28.6±0.75</b> 1.125	20	.32	-	125	200	-
<b>2661665702</b>	<b>17.45±0.4</b> .687	<b>9.5±0.25</b> .375	<b>28.6±0.75</b> 1.125	20	.32	-	-	156	260
2631626302	<b>19.0 - 0.65</b> .735	<b>10.15±0.25</b> .400	<b>14.65 - 0.75</b> .562	12	.29	44	69	115	-
2643626302	<b>19.0 - 0.65</b> .735	<b>10.15±0.25</b> .400	<b>14.65 - 0.75</b> .562	12	.29	-	63	96	-
2631626402	<b>19.0 - 0.65</b> .735	<b>10.15±0.25</b> .400	<b>28.6±0.75</b> 1.125	23	.29	89	138	225	-
<b>2643626402</b>	<b>19.0 - 0.65</b> .735	<b>10.15±0.25</b> .400	<b>28.6±0.75</b> 1.125	23	.29	-	128	196	-
<b>2643626502</b>	<b>19.0 - 0.65</b> .735	<b>10.15±0.25</b> .400	<b>50.8±1.0</b> 2.000	41	.29	-	225	348	-
2643801502	<b>25.4±0.65</b> 1.000	<b>12.7±0.35</b> .500	<b>6.35±0.25</b> .250	9.9	.23	-	34	53	-

\*\*Bold part numbers designate preferred parts.

\*This dimension may be modified to suit specific applications.

<sup>1</sup> Guaranteed Z Min is Z Typ -20%

P.O. Box J, One Commercial Row, Wallkill, NY 12589-0288

Fair-Rite Products Corp.

Phone: (888) FAIR RITE / (845) 895-2055 • FAX: (888) FERRITE / (845) 895-2629 • www.fair-rite.com • E-Mail: ferrites@fair-rite.com  
(888) 324-7748 (888) 337-7483 Note: (914) Area Code has changed to (845).

# Round Cable EMI Suppression Cores

Listed in ascending order of "B" dimension.

Dimensions (Bold numbers are in millimeters, light numbers are nominal in inches.)

Typical Impedance( $\Omega$ )<sup>1</sup>

Part Number**	A	B	C*	Wt (g)	H (Oe)	10 MHz	25 MHz	100 MHz	250 MHz
<b>2643102402</b>	<b>25.9±0.75</b> 1.020	<b>12.8±0.25</b> .505	<b>21.3±0.5</b> .840	35	.22	-	110	183	-
<b>2661102402</b>	<b>25.9±0.75</b> 1.020	<b>12.8±0.25</b> .505	<b>21.3±0.5</b> .840	35	.22	-	-	169	275
<b>2631102002</b>	<b>25.9±0.75</b> 1.020	<b>12.8±0.25</b> .505	<b>28.6±0.8</b> 1.125	46	.22	103	156	260	-
<b>2643102002</b>	<b>25.9±0.75</b> 1.020	<b>12.8±0.25</b> .505	<b>28.6±0.8</b> 1.125	46	.22	-	145	235	-
2661102002	<b>25.9±0.75</b> 1.020	<b>12.8±0.25</b> .505	<b>28.6±0.8</b> 1.125	46	.22	-	-	225	310
2643800602	<b>20.95±0.4</b> .825	<b>13.2±0.3</b> .520	<b>6.35±0.2</b> .250	5.8	.24	-	24	44	-
2643800502	<b>20.95±0.4</b> .825	<b>13.2±0.3</b> .520	<b>11.9±0.4</b> .468	11	.24	-	45	82	-
<b>2643801802</b>	<b>22.1±0.4</b> .870	<b>13.7±0.3</b> .540	<b>6.35±0.2</b> .250	6.5	.23	-	25	45	-
2631101902	<b>28.5±0.6</b> 1.122	<b>13.8±0.3</b> .543	<b>28.6±0.8</b> 1.125	56	.21	106	163	270	-
2643101902	<b>28.5±0.6</b> 1.122	<b>13.8±0.3</b> .543	<b>28.6±0.8</b> 1.125	56	.21	-	145	230	-
2643801402	<b>25.4±0.6</b> 1.000	<b>15.5±0.5</b> .610	<b>8.1±0.3</b> .320	11	.20	-	35	55	-
2643806402	<b>25.4±0.6</b> 1.000	<b>15.5±0.5</b> .610	<b>12.7±0.4</b> .500	17	.20	-	53	90	-
<b>2643251002</b>	<b>39.1±0.75</b> 1.540	<b>16.75±0.5</b> .660	<b>22.2±0.8</b> .875	84	.16	-	135	230	-
<b>2643801002</b>	<b>29.0±0.75</b> 1.142	<b>19.0±0.5</b> .748	<b>7.5±0.25</b> .295	12	.17	-	28	47	-
2643801202	<b>29.0±0.75</b> 1.142	<b>19.0±0.5</b> .748	<b>13.85±0.4</b> .545	23	.17	-	51	92	-
<b>2643804502</b>	<b>31.1±0.75</b> 1.225	<b>19.05±0.5</b> .750	<b>16.3 - 0.75</b> .627	33	.17	-	60	100	-
<b>2643802702</b>	<b>35.55±0.75</b> 1.400	<b>22.85±0.5</b> .900	<b>12.7±0.5</b> .500	32	.14	-	48	80	-
2643626102	<b>50.8±1.0</b> 2.000	<b>25.4±0.5</b> 1.000	<b>25.4±0.75</b> 1.000	158	.11	-	128	224	-
2643625902	<b>50.8±1.0</b> 2.000	<b>25.4±0.5</b> 1.000	<b>28.7±0.75</b> 1.130	178	.11	-	145	254	-
<b>2643626202</b>	<b>50.8±1.0</b> 2.000	<b>25.4±0.5</b> 1.000	<b>38.1±0.75</b> 1.500	237	.11	-	193	336	-
2643626002	<b>50.8±1.0</b> 2.000	<b>25.4±0.5</b> 1.000	<b>50.8±1.0</b> 2.000	315	.11	-	240	360	-
<b>2643803802</b>	<b>61.0±1.3</b> 2.400	<b>35.55±0.75</b> 1.400	<b>12.7±0.5</b> .500	105	.09	-	58	108	-

\*\*Bold part numbers designate preferred parts.

<sup>1</sup> Guaranteed Z Min is Z Typ -20%

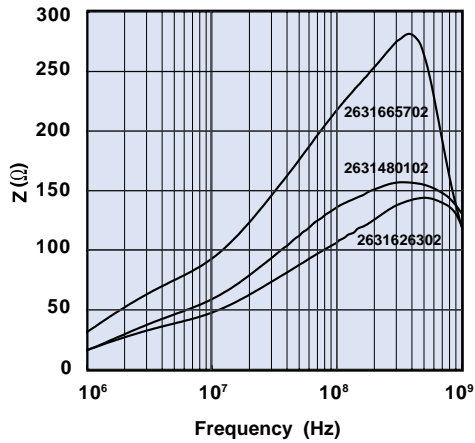
\*This dimension may be modified to suit specific applications.

**Fair-Rite Products Corp.** P.O. Box J, One Commercial Row, Wallkill, NY 12589-0288

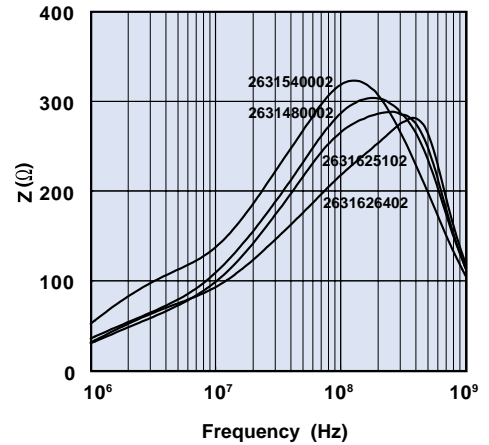
Phone: (888) FAIR RITE / (845) 895-2055 • FAX: (888) FERRITE / (845) 895-2629 • www.fair-rite.com • E-Mail: ferrites@fair-rite.com  
(888) 324-7748 (888) 337-7483 **Note: (914) Area Code has changed to (845).**



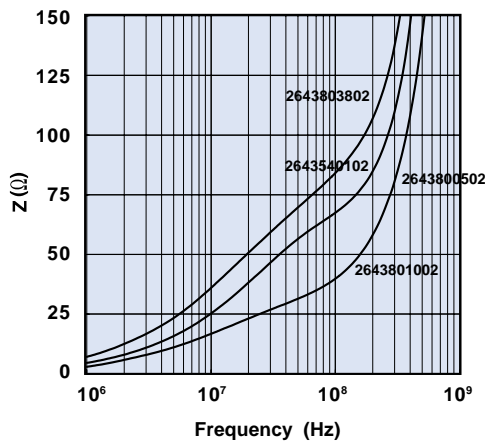
# Round Cable EMI Suppression Cores



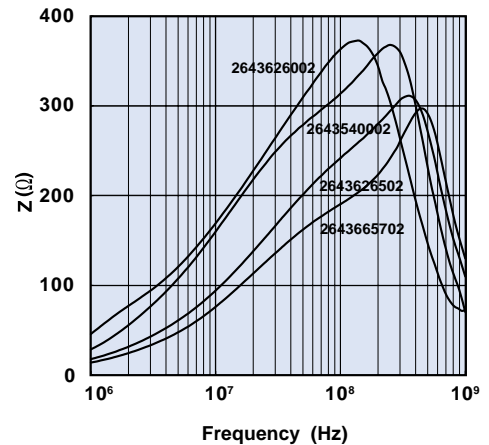
**Figure 1** Impedance vs. Frequency for 31 material round cable EMI suppression cores.



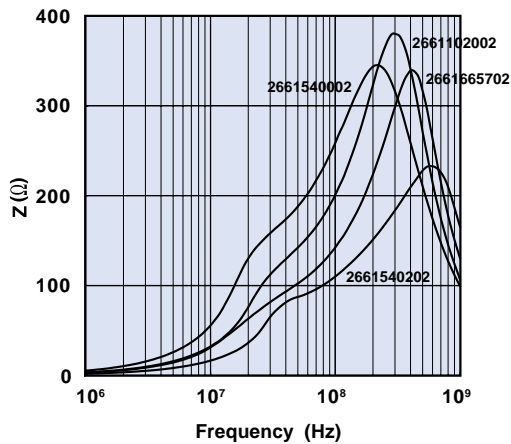
**Figure 2** Impedance vs. Frequency for 31 material round cable EMI suppression cores.



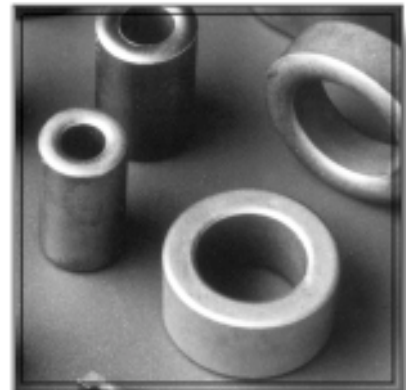
**Figure 3** Impedance vs. Frequency for 43 material round cable EMI suppression cores.



**Figure 4** Impedance vs. Frequency for 43 material round cable EMI suppression cores.



**Figure 5** Impedance vs. Frequency for 61 material round cable EMI suppression cores.



# Split Round Cable EMI Suppression Cores

Suppression cores for round cables are available for a range of cable diameters. Installed around a cable, these 43 and 44 material cores, provide common-mode filtering for multi-strand cables and differential mode filtering for single conductors.

Polypropylene cases make the assembly of the core halves a snap. Cores are easily installed in equipment where a retrofit proves necessary. See page 101 for available cases.

- Cores are controlled for impedance limits only. Two cores making a set are tested for impedance with a single turn, using a Hewlett Packard HP 4193A Vector Impedance Meter.
- Cores are sold as pieces.
- For one piece round cable EMI suppression cores, see page 94.
- For split round cable EMI suppression cores assembled into cases, see page 101.
- For impedance vs. frequency curves, see Figures 3-12.
- For any split round cable EMI suppression core requirement not listed in the catalog, please contact our customer service group for availability and pricing.
- The Expanded Cable and Connector EMI Suppressor Kit (part number 0199000005) contains a selection of these suppression cores. See page 92.

**Dimensions** (Bold numbers are in millimeters, light numbers are nominal in inches.)

Typical Impedance( $\Omega$ )<sup>1</sup>

Part Number*	Fig.	Max. Cable Diameter	A	B	C	D	Wt (g)	25 MHz	100 MHz	Case P/N**	Case Fig.**	Z, R <sub>s</sub> , X <sub>L</sub> vs. Frequency Curve
<b>2643166751</b>	1	<b>2.5</b> .100	<b>7.65 - 0.25</b> .296	<b>2.3+0.25</b> .095	<b>7.8 - 0.5</b> .297	<b>3.9 - 0.25</b> .148	1.1	60	93	—	—	Figure 3
<b>2643165451</b>	1	<b>6.4</b> .250	<b>15.0±0.25</b> .590	<b>6.6±0.3</b> .260	<b>15.25±0.6</b> .600	<b>7.5±0.15</b> .295	7.3	94	155	—	—	Figure 4
<b>2643164251</b>	1	<b>6.4</b> .250	<b>15.0±0.25</b> .590	<b>6.6±0.3</b> .260	<b>28.6±0.8</b> 1.125	<b>7.5±0.15</b> .295	14	163	275	0199164251	1	Figure 5
<b>2643625006</b>	2	<b>7.6</b> .300	<b>15.9±0.4</b> .626	<b>7.9±0.3</b> .311	<b>14.3±0.4</b> .563	<b>7.95±0.2</b> .313	5.0	50	113	0199625006	2	Figure 6
<b>2643665806</b>	2	<b>9.3</b> .365	<b>17.5±0.5</b> .689	<b>9.5±0.3</b> .374	<b>12.7±0.4</b> .500	<b>8.75±0.25</b> .344	5.2	41	88	0199665806	2	Figure 7
<b>2643167251</b>	1	<b>10.0</b> .394	<b>18.65±0.4</b> .735	<b>10.15±0.3</b> .400	<b>28.6±0.8</b> 1.125	<b>9.4±0.15</b> .370	18	130	225	0199167251	1	Figure 8
<b>2643800506</b>	2	<b>12.7</b> .500	<b>21.0±0.5</b> .827	<b>13.2±0.4</b> .520	<b>11.9±0.4</b> .469	<b>10.5±0.25</b> .413	6.0	35	75	0199800506	2	Figure 9
<b>2643164151</b>	1	<b>12.7</b> .500	<b>25.9±0.5</b> 1.020	<b>13.05±0.3</b> .514	<b>28.6±0.8</b> 1.125	<b>12.95±0.25</b> .510	38	156	250	0199164151	1	Figure 10
<b>2643806406</b>	2	<b>15.0</b> .591	<b>25.4±0.6</b> 1.000	<b>15.5±0.5</b> .610	<b>12.7±0.4</b> .500	<b>12.7±0.3</b> .500	9.7	43	90	0199806406	2	Figure 11
<b>2644173551</b>	1	<b>19.0</b> .750	<b>25.9±0.5</b> 1.020	<b>18.8±0.3</b> .740	<b>38.9±0.4</b> 1.532	<b>13.0±0.25</b> .512	39	94	195	0199173551	1	Figure 12

\*Bold part numbers designate preferred parts.

<sup>1</sup> Guaranteed Z Min is Z Typ -20%

\*\*Refer to page 101 for dimensions and figures for split round cable EMI suppression core cases.

**Fair-Rite Products Corp.** P.O. Box J, One Commercial Row, Wallkill, NY 12589-0288

Phone: (888) FAIR RITE / (845) 895-2055 • FAX: (888) FERRITE / (845) 895-2629 • www.fair-rite.com • E-Mail: ferrites@fair-rite.com  
(888) 324-7748 (888) 337-7483 **Note: (914) Area Code has changed to (845).**

# Split Round Cable EMI Suppression Cores

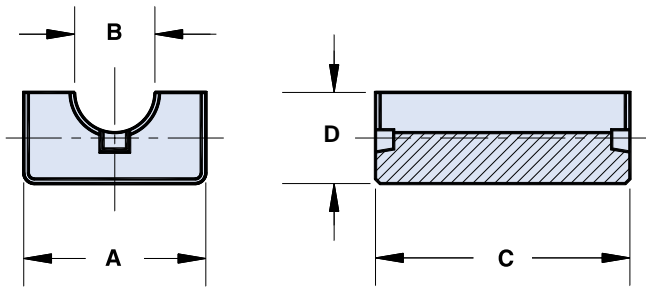


Figure 1

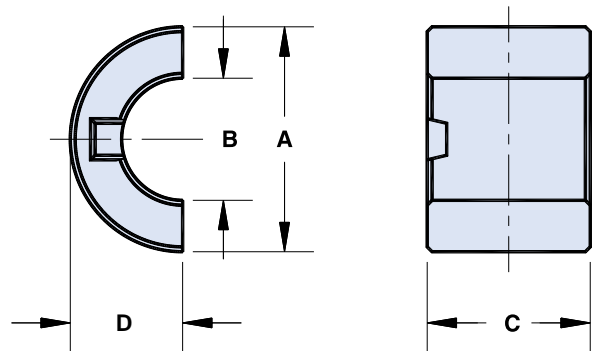


Figure 2

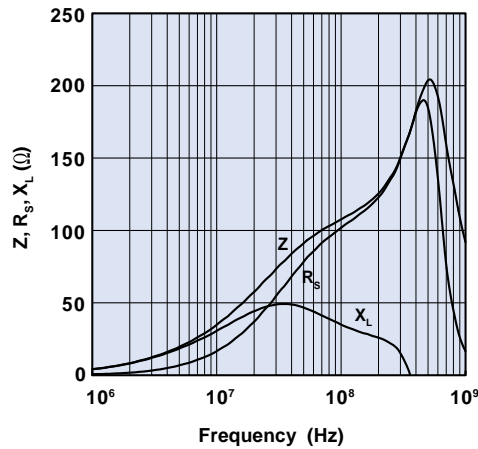


Figure 3 Impedance, Reactance, and Resistance vs. Frequency for 43 material split round cable EMI suppression core 2643166751.

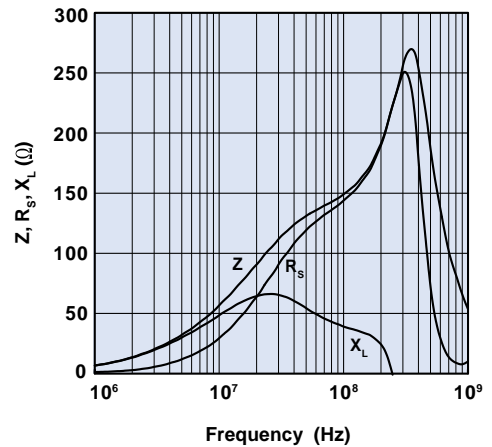


Figure 4 Impedance, Reactance, and Resistance vs. Frequency for 43 material split round cable EMI suppression core 2643165451.

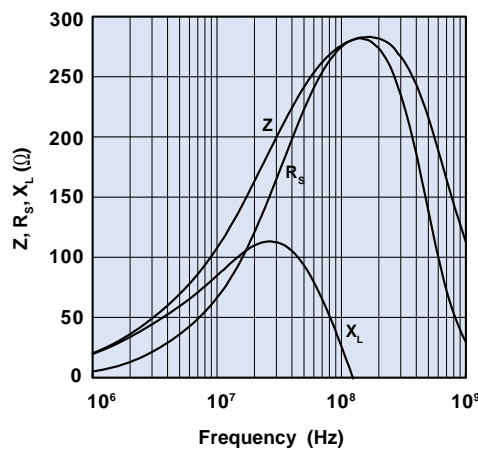


Figure 5 Impedance, Reactance, and Resistance vs. Frequency for 43 material split round cable EMI suppression core 2643164251.

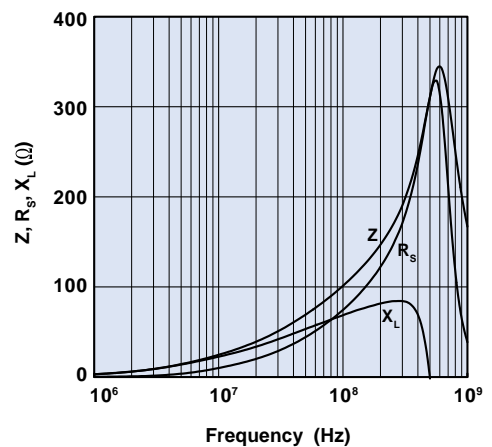
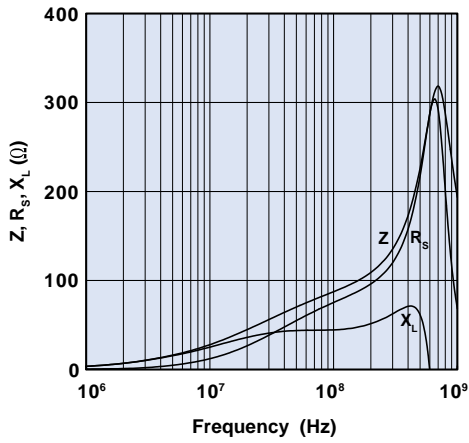
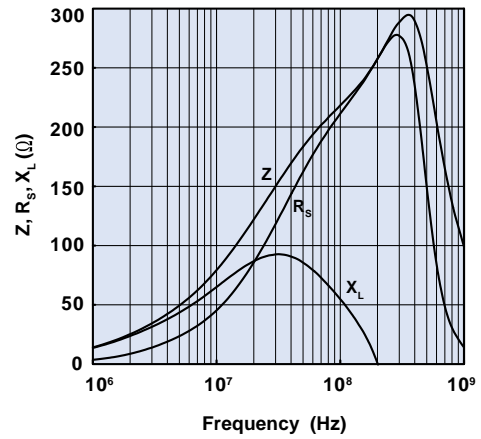


Figure 6 Impedance, Reactance, and Resistance vs. Frequency for 43 material split round cable EMI suppression core 2643625006.

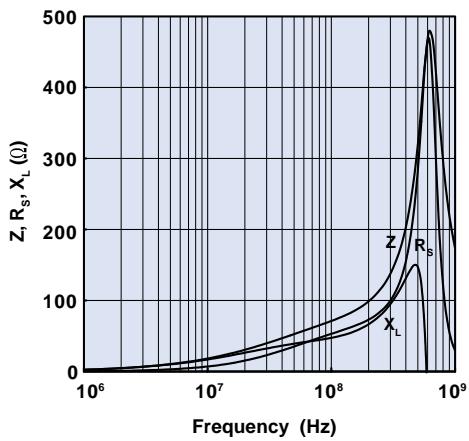
# Split Round Cable EMI Suppression Cores



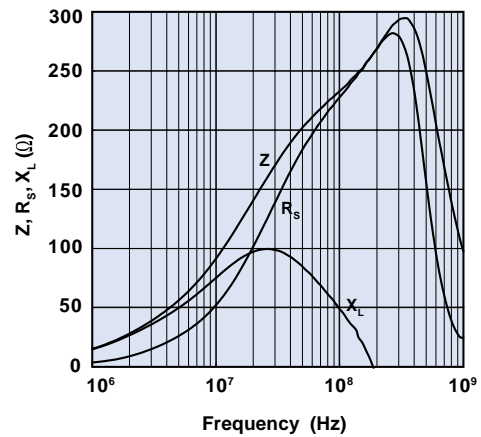
**Figure 7** Impedance, Reactance, and Resistance vs. Frequency for 43 material split round cable EMI suppression core 2643665806.



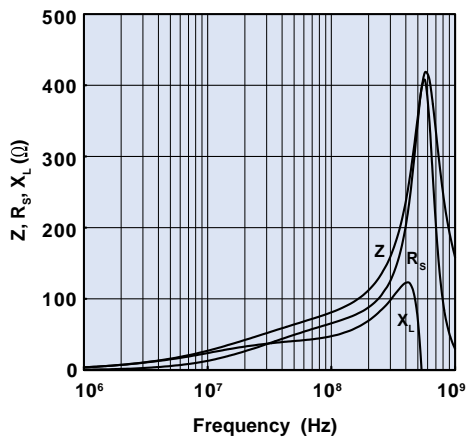
**Figure 8** Impedance, Reactance, and Resistance vs. Frequency for 43 material split round cable EMI suppression core 2643167251.



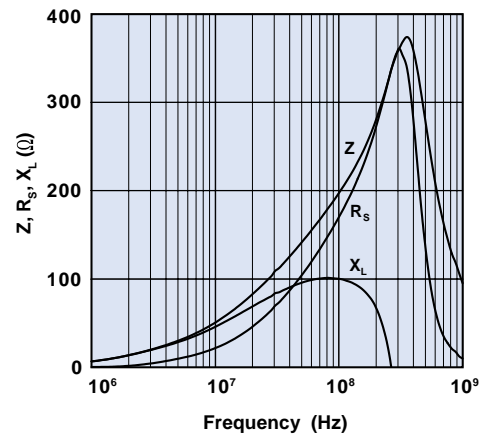
**Figure 9** Impedance, Reactance, and Resistance vs. Frequency for 43 material split round cable EMI suppression core 2643800506.



**Figure 10** Impedance, Reactance, and Resistance vs. Frequency for 43 material split round cable EMI suppression core 2643164151.



**Figure 11** Impedance, Reactance, and Resistance vs. Frequency for 43 material split round cable EMI suppression core 2643806406.



**Figure 12** Impedance, Reactance, and Resistance vs. Frequency for 44 material split round cable EMI suppression core 2644173551.

# Split Round Cable EMI Suppression Cores

Several cases are available which makes the assembly of the core halves a snap. The polypropylene cases have a flammability rating of UL 94-V0.

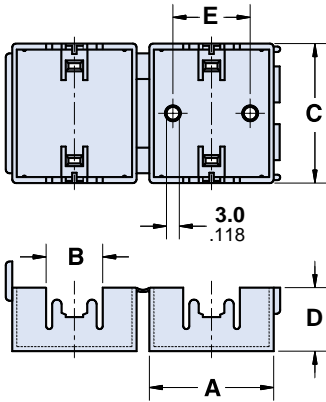


Figure 1

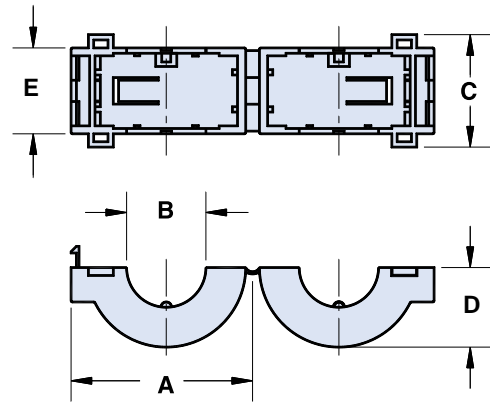


Figure 2

**Dimensions** (Bold numbers are in millimeters, light numbers are nominal in inches.)

Part Number Case	Fig.	A	B	C	D	E	Part Number* Case & 2 Ferrite Parts
0199164251	1	<b>17.9</b> .705	<b>7.0</b> .275	<b>32.3</b> 1.272	<b>9.2</b> .362	<b>9.0</b> .354	0443164251
0199625006	2	<b>24.7</b> .972	<b>7.9</b> .311	<b>22.8</b> .898	<b>10.2</b> .402	<b>17.8</b> .701	0443625006
0199665806	2	<b>26.3</b> 1.035	<b>9.2</b> .362	<b>21.4</b> .843	<b>11.0</b> .433	<b>16.4</b> .646	0443665806
0199167251	1	<b>22.1</b> .870	<b>10.2</b> .402	<b>32.3</b> 1.272	<b>11.0</b> .433	<b>9.0</b> .354	0443167251
0199800506 <sup>+</sup>	2	<b>29.7</b> 1.169	<b>12.8</b> .504	<b>20.6</b> .811	<b>12.7</b> .500	<b>15.6</b> .614	0443800506
0199164151	1	<b>29.0</b> 1.142	<b>13.4</b> .528	<b>32.5</b> 1.280	<b>14.8</b> .583	<b>18.0</b> .709	0443164151
0199806406	2	<b>34.3</b> 1.350	<b>15.0</b> .591	<b>21.2</b> .835	<b>15.0</b> .591	<b>16.2</b> .638	0443806406
0199173551	1	<b>29.2</b> 1.150	<b>19.4</b> .764	<b>42.0</b> 1.654	<b>14.7</b> .579	-	0444173551

\* See page 102.

<sup>+</sup> Case is Nylon 6/6 - Flammability rating UL94-V2.

# Round Cable Snap-its

Round Cable Snap-its can accommodate round cables with diameters from .160 to .750 inches. These parts are available in several materials and can be used to suppress frequencies up to 500 MHz. These cable cores will provide common-mode filtering for multi-strand cables and differential mode filtering for single conductors.

The polypropylene cases have a flammability rating of UL 94-V0.

- Cores are controlled for impedance limits only. Two cores making a set are tested for impedance with a single turn, using a Hewlett Packard HP 4193A Vector Impedance Meter.
- For one piece round cable EMI suppression cores, see page 94.
- For impedance vs. frequency curves for these parts, see Figures 4-23.
- For any round cable snap-it core requirement not listed in the catalog, please contact our customer service group for availability and pricing.
- The Expanded Cable and Connector EMI Suppressor Kit (part number 0199000005) and the Snap-it Cable Suppressor Kit (part number 0199000017) contain a selection of these suppression cores. See page 92.

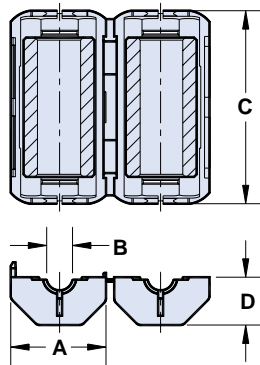


Figure 1

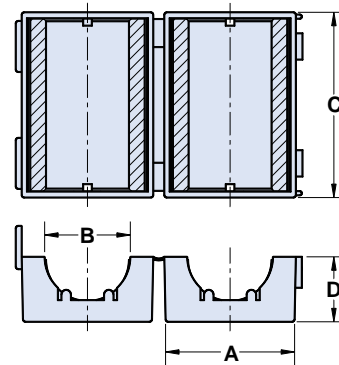


Figure 2

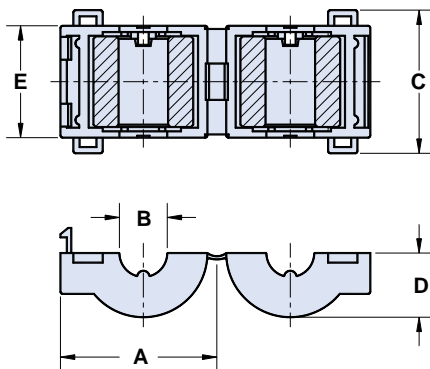


Figure 3

# Round Cable Snap-its

Dimensions (Bold numbers are in millimeters, light numbers are nominal in inches.)

Part Number*	Fig.	Cable Diameter	A	B**	C	D	E	Typical Impedance( $\Omega$ ) <sup>1</sup>			Z, R <sub>s</sub> , X <sub>L</sub> vs. Frequency Curve
								10 MHz	25 MHz	100 MHz	
<b>0431173951</b>	1	<b>5.3 Max.</b> .210 Max.	<b>12.8</b> .504	<b>5.1</b> .200	<b>25.0</b> .984	<b>5.6</b> .220	-	60	100	180	Figure 4
<b>0444173951</b>	1	<b>5.3 Max.</b> .210 Max.	<b>12.8</b> .504	<b>5.1</b> .200	<b>25.0</b> .984	<b>5.6</b> .220	-	-	94	150	Figure 5
<b>0431164951</b>	1	<b>5.3 Max.</b> .210 Max.	<b>17.3</b> .680	<b>5.1</b> .200	<b>36.2</b> 1.42	<b>8.4</b> .331	-	100	169	280	Figure 6
<b>0444164951</b>	1	<b>5.3 Max.</b> .210 Max.	<b>17.3</b> .680	<b>5.1</b> .200	<b>36.2</b> 1.42	<b>8.4</b> .331	-	-	144	245	Figure 7
<b>0443164251</b>	2	<b>6.4 Max.</b> .250 Max.	<b>17.9</b> .705	<b>7.0</b> .275	<b>32.3</b> 1.272	<b>9.2</b> .362	-	-	163	275	Figure 8
<b>0431164281</b>	1	<b>7.0 Max.</b> .275 Max.	<b>20.0</b> .788	<b>6.6</b> .260	<b>39.4</b> 1.55	<b>9.78</b> .385	-	113	188	310	Figure 9
<b>0444164281</b>	1	<b>7.0 Max.</b> .275 Max.	<b>20.0</b> .788	<b>6.6</b> .260	<b>39.4</b> 1.55	<b>9.78</b> .385	-	-	156	260	Figure 10
<b>0443625006</b>	3	<b>7.6 Max.</b> .300 Max.	<b>24.7</b> .972	<b>7.9</b> .311	<b>22.8</b> .898	<b>10.2</b> .402	<b>17.8</b> .701	-	50	113	Figure 11
<b>0443665806</b>	3	<b>9.3 Max.</b> .365 Max.	<b>26.3</b> 1.035	<b>9.2</b> .362	<b>21.4</b> .843	<b>11.0</b> .433	<b>16.4</b> .646	-	41	88	Figure 12
<b>0443167251</b>	2	<b>10.0 Max.</b> .390 Max.	<b>22.1</b> .870	<b>10.2</b> .402	<b>32.3</b> 1.272	<b>11.0</b> .433	-	-	138	225	Figure 13
<b>0431167281</b>	1	<b>10.5 Max.</b> .410 Max.	<b>23.7</b> .933	<b>10.2</b> .400	<b>39.4</b> 1.55	<b>11.70</b> .461	-	81	144	240	Figure 14
<b>0444167281</b>	1	<b>10.5 Max.</b> .410 Max.	<b>23.7</b> .933	<b>10.2</b> .400	<b>39.4</b> 1.55	<b>11.70</b> .461	-	-	125	210	Figure 15
<b>0443800506</b> <sup>+</sup>	3	<b>12.7 Max.</b> .500 Max.	<b>29.7</b> 1.169	<b>12.8</b> .504	<b>20.6</b> .811	<b>12.7</b> .500	<b>15.6</b> .614	-	35	75	Figure 16
<b>0443164151</b>	2	<b>12.7 Max.</b> .500 Max.	<b>29.0</b> 1.142	<b>13.4</b> .528	<b>32.5</b> 1.280	<b>14.8</b> .583	-	-	156	250	Figure 17
<b>0431164181</b>	1	<b>13.3 Max.</b> .525 Max.	<b>31.0</b> 1.220	<b>13.0</b> .512	<b>39.4</b> 1.55	<b>15.25</b> .600	-	100	156	260	Figure 18
<b>0444164181</b>	1	<b>13.3 Max.</b> .525 Max.	<b>31.0</b> 1.220	<b>13.0</b> .512	<b>39.4</b> 1.55	<b>15.25</b> .600	-	-	138	230	Figure 19
<b>0443806406</b>	3	<b>15.0 Max.</b> .590 Max.	<b>34.3</b> 1.350	<b>15.0</b> .591	<b>21.2</b> .835	<b>15.0</b> .591	<b>16.2</b> .638	-	43	90	Figure 20
<b>0431173551</b>	2	<b>19.0 Max.</b> .750 Max.	<b>29.2</b> 1.150	<b>18.8</b> .740	<b>42.0</b> 1.65	<b>14.7</b> .579	-	69	125	220	Figure 21
<b>0444173551</b>	2	<b>19.0 Max.</b> .750 Max.	<b>29.2</b> 1.150	<b>18.8</b> .740	<b>42.0</b> 1.65	<b>14.7</b> .579	-	-	94	195	Figure 22
<b>0444176451</b>	1	<b>19.0 Max.</b> .750 Max.	<b>38.6</b> 1.52	<b>18.35</b> .722	<b>47.5</b> 1.87	<b>19.15</b> .754	-	-	175	365	Figure 23
<b>0444177081</b>	1	<b>25.9 Max.</b> 1.020 Max.	<b>56.4</b> 2.22	<b>25.4</b> 1.00	<b>42.95</b> 1.69	<b>27.45</b> 1.08	-	-	194	338	Figure 24

\* Bold part numbers designate preferred parts.

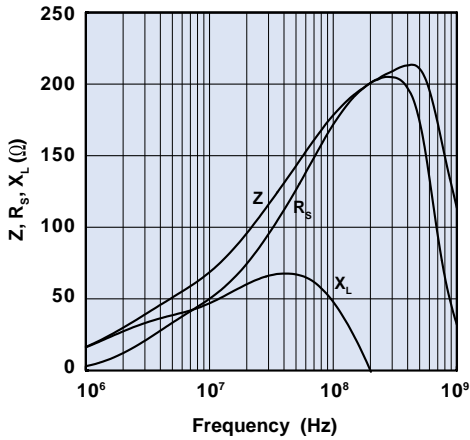
\*\* "B" dimension is the core dimension.

<sup>+</sup> Case is Nylon 6/6 - Flammability rating UL94-V2.

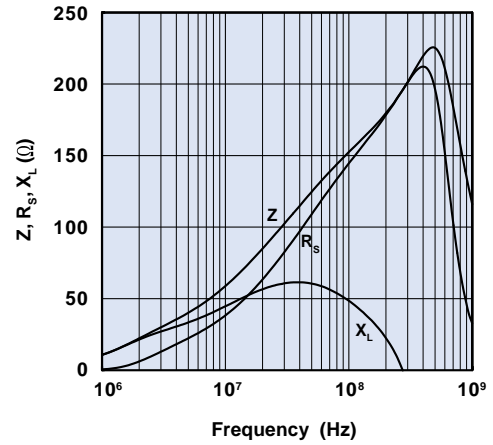
<sup>1</sup> Guaranteed Z Min is Z Typ -20%

NOTE: See page 185 for additional new High Frequency Split Round Suppressor Cores in 61 material. These cores will operate from 10 MHz into the GHz's frequency range.

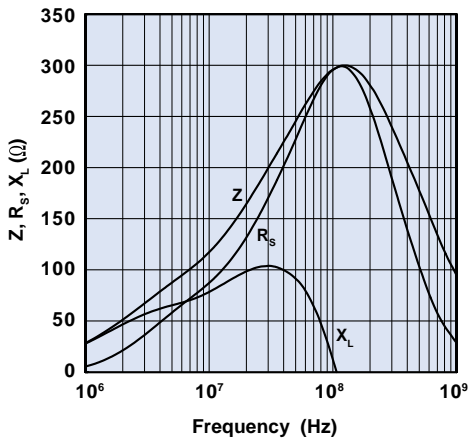
# Round Cable Snap-its



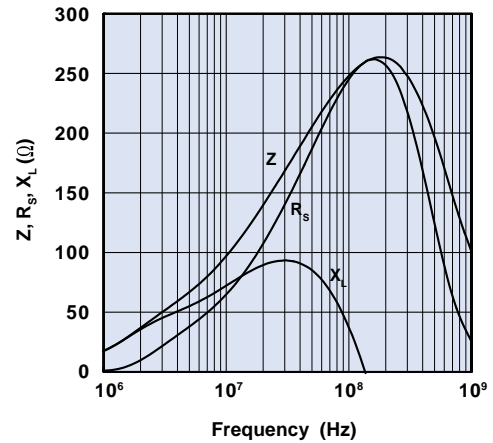
**Figure 4** Impedance, Reactance, and Resistance vs. Frequency for round cable snap-it 0431173951.



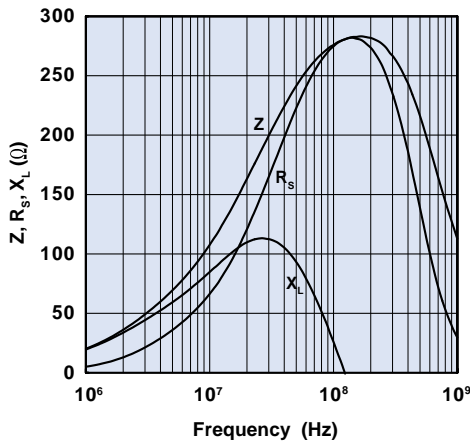
**Figure 5** Impedance, Reactance, and Resistance vs. Frequency for round cable snap-it 0444173951.



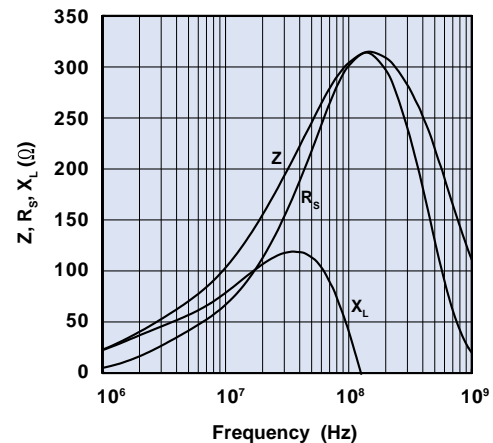
**Figure 6** Impedance, Reactance, and Resistance vs. Frequency for round cable snap-it 0431164951.



**Figure 7** Impedance, Reactance, and Resistance vs. Frequency for round cable snap-it 0444164951.



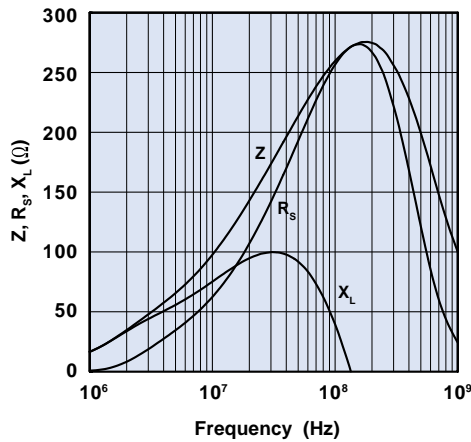
**Figure 8** Impedance, Reactance, and Resistance vs. Frequency for round cable snap-it 0443164251.



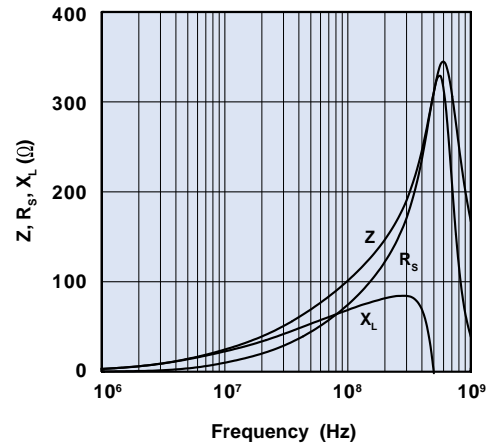
**Figure 9** Impedance, Reactance, and Resistance vs. Frequency for round cable snap-it 0431164281.



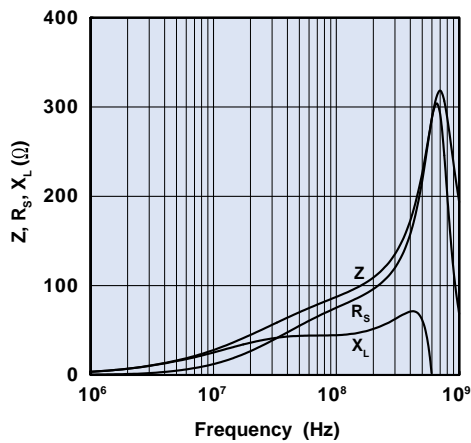
# Round Cable Snap-its



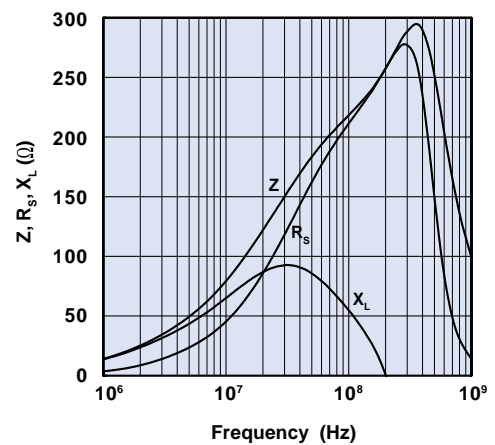
**Figure 10** Impedance, Reactance, and Resistance vs. Frequency for round cable snap-it 0444164281.



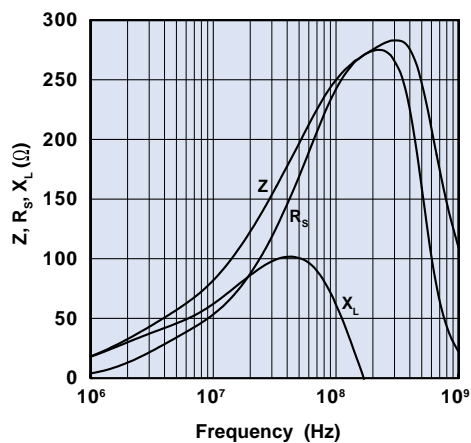
**Figure 11** Impedance, Reactance, and Resistance vs. Frequency for round cable snap-it 0443625006.



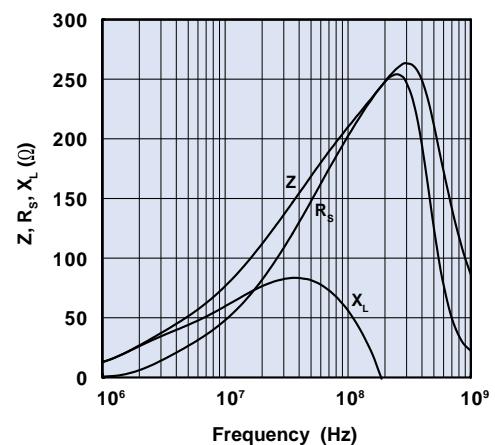
**Figure 12** Impedance, Reactance, and Resistance vs. Frequency for round cable snap-it 0443665806.



**Figure 13** Impedance, Reactance, and Resistance vs. Frequency for round cable snap-it 0443167251.



**Figure 14** Impedance, Reactance, and Resistance vs. Frequency for round cable snap-it 0431167281.



**Figure 15** Impedance, Reactance, and Resistance vs. Frequency for round cable snap-it 0444167281.

# Round Cable Snap-its

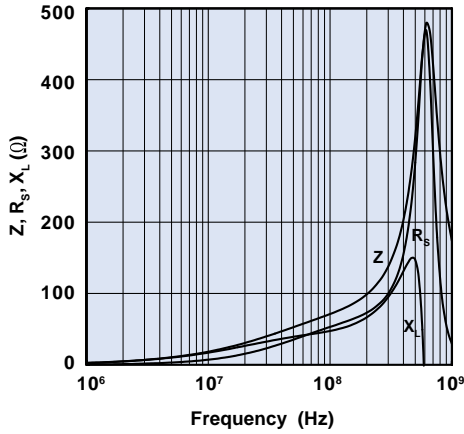


Figure 16 Impedance, Reactance, and Resistance vs. Frequency for round cable snap-it 0443800506.

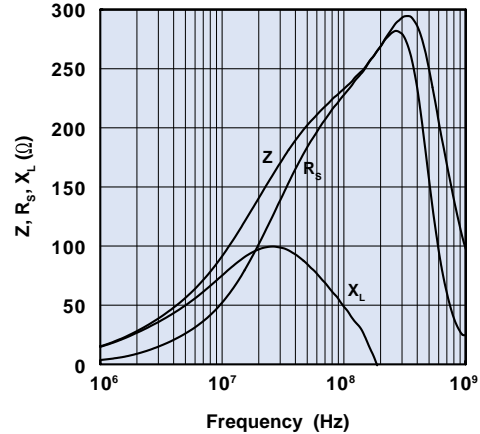


Figure 17 Impedance, Reactance, and Resistance vs. Frequency for round cable snap-it 0443164151.

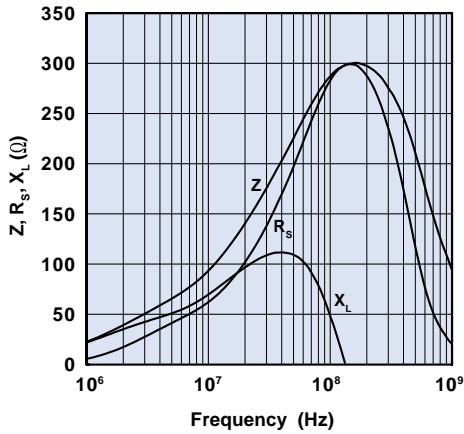


Figure 18 Impedance, Reactance, and Resistance vs. Frequency for round cable snap-it 0431164181.

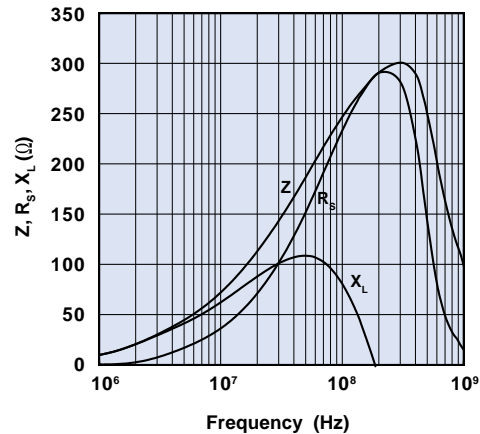


Figure 19 Impedance, Reactance, and Resistance vs. Frequency for round cable snap-it 0444164181.

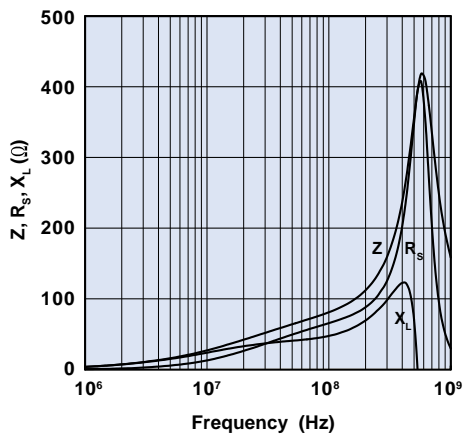


Figure 20 Impedance, Reactance, and Resistance vs. Frequency for round cable snap-it 0443806406.

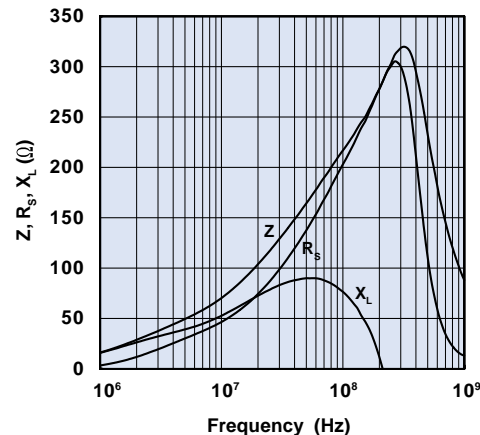
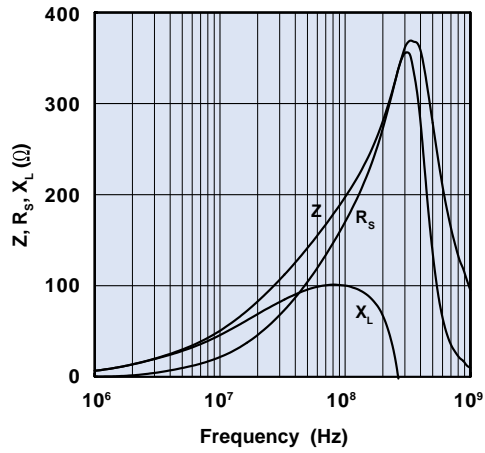
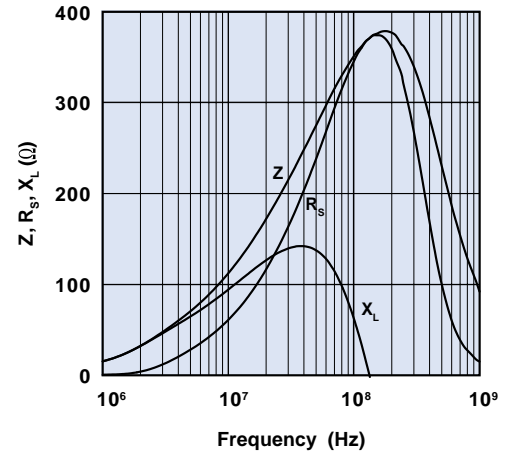


Figure 21 Impedance, Reactance, and Resistance vs. Frequency for round cable snap-it 0431173551.

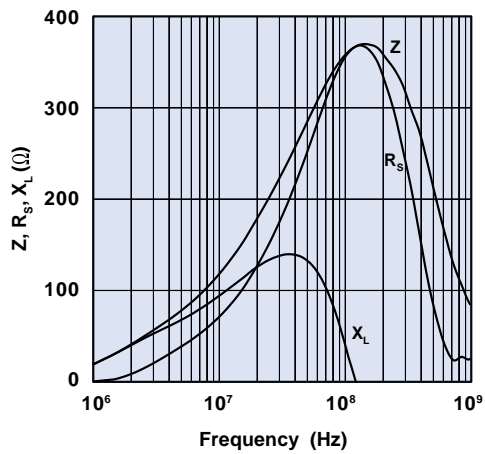
# Round Cable Snap-its



**Figure 22** Impedance, Reactance, and Resistance vs. Frequency for round cable snap-it 0444173551.



**Figure 23** Impedance, Reactance, and Resistance vs. Frequency for round cable snap-it 0444176451.



**Figure 24** Impedance, Reactance, and Resistance vs. Frequency for round cable snap-it 0444177081.

# Flat Cable EMI Suppression Cores

Fair-Rite offers a line of flat cable EMI suppression cores to attenuate radiated EMI emissions from ribbon cables. These cores can accommodate a range of cable sizes and conductors.

See page 115 for cases and clips to assist in the assembly of the split cable core halves.

For Flat Cable Snap-its, see page 116.

- Impedance values for parts shown in Figures 1, 2, and 3 are for a core set. Parts shown in Figures 1, 2, and 3 are sold as pieces.
- Cores are controlled for impedance limits only. They are tested for impedance with a single turn, using a Hewlett Packard HP 4193A Vector Impedance Meter.
- For impedance vs. frequency curves for these parts, see Figures 6-35.
- For any flat cable EMI suppression core requirement not listed in the catalog, please contact our customer service group for availability and pricing.
- The Expanded Cable and Connector EMI Suppressor Kit (part number 0199000005) contains a selection of these suppression cores. See page 92.

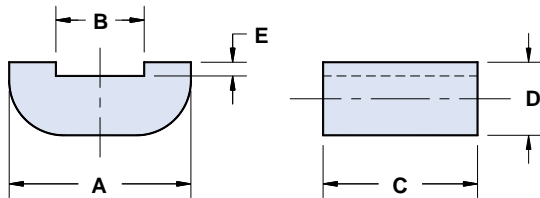


Figure 1

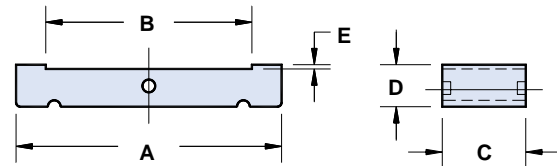


Figure 2

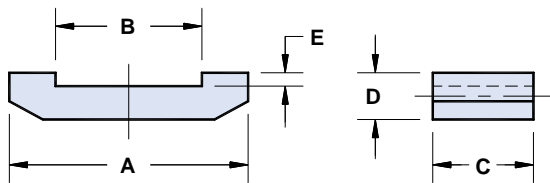


Figure 3

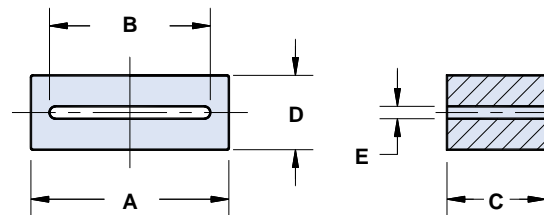


Figure 4

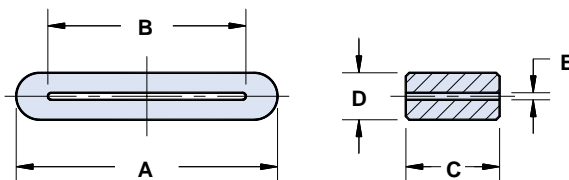


Figure 5

**Fair-Rite Products Corp.** P.O. Box J, One Commercial Row, Wallkill, NY 12589-0288

Phone: (888) FAIR RITE / (845) 895-2055 • FAX: (888) FERRITE / (845) 895-2629 • www.fair-rite.com • E-Mail: ferrites@fair-rite.com  
(888) 324-7748 Note: (914) Area Code has changed to (845).

# Flat Cable EMI Suppression Cores

Dimensions (Bold numbers are in millimeters, light numbers are nominal in inches.)

Part Number**	Fig.	Max. Cable Width	A	B	C*	D	E	Wt (g)	Typical Impedance(Ω) <sup>1</sup>			Clip P/N	Case P/N	Z, R <sub>s</sub> , X <sub>L</sub> vs. Frequency Curve
									10 MHz	25 MHz	100 MHz			
2643171351	1	<b>6.4mm</b> .250	<b>11.4±0.25</b> .450	<b>6.6±0.15</b> .260	<b>7.6±0.25</b> .300	<b>3.3 - 0.25</b> .125	<b>0.15±0.15</b> .009	1.4	—	50	80	—	—	Figure 6
2643172751	2	<b>10mm</b> .385	<b>14.5±0.2</b> .571	<b>10.0±0.13</b> .394	<b>10.0±0.13</b> .394	<b>2.5±0.15</b> .098	<b>0.5±0.25</b> .025	1.5	—	31	59	—	—	Figure 7
2643173851	2^	<b>12mm</b> .490	<b>16.5±0.25</b> .650	<b>12.5±0.2</b> .492	<b>10.25±0.25</b> .404	<b>2.0±0.15</b> .079	<b>0.5±0.25</b> .025	1.3	—	33	60	—	—	Figure 8
2643170251	3	<b>12mm</b> .490	<b>22.75±0.65</b> .895	<b>12.7±0.5</b> .500	<b>12.7±0.5</b> .500	<b>3.3 - 0.25</b> .125	<b>1.15±0.25</b> .050	3.5	—	39	71	—	—	Figure 9
2643169552	4	<b>14mm</b> .550	<b>19.95±0.4</b> .785	<b>14.2±0.25</b> .560	<b>10.15±0.5</b> .400	<b>6.35±0.25</b> .250	<b>0.9±0.15</b> .035	5.7	—	35	75	—	—	Figure 10
2643168751	4	<b>17mm</b> .680	<b>25.4±0.75</b> 1.000	<b>17.8±0.5</b> .700	<b>12.7±0.4</b> .500	<b>10.15±0.25</b> .400	<b>2.55±0.25</b> .100	13	—	44	85	—	—	Figure 11
2643173351	5	<b>20mm</b> .770	<b>24.5±0.4</b> .965	<b>20.0±0.4</b> .787	<b>12.0±0.3</b> .472	<b>5.0±0.25</b> .197	<b>0.75±0.25</b> .030	6.6	—	31	55	—	—	Figure 12
2643168651	3	<b>26mm</b> 1.030	<b>38.85±0.75</b> 1.530	<b>26.15±0.75</b> 1.030	<b>28.6±0.7</b> 1.125	<b>13.0±0.3</b> .512	<b>6.35±0.25</b> .255	45	—	100	185	—	—	Figure 13
2643164551	4	<b>26mm</b> 1.030	<b>38.1±1.0</b> 1.500	<b>26.65±0.75</b> 1.050	<b>12.3±0.4</b> .485	<b>12.05±0.4</b> .475	<b>1.9±0.4</b> .075	25	—	48	98	—	—	Figure 14
<b>2643171051</b>	2	<b>26mm</b> 1.030	<b>38.1±1.0</b> 1.500	<b>26.65±0.75</b> 1.050	<b>12.7±0.4</b> .500	<b>6.35±0.25</b> .250	<b>0.85±0.2</b> .033	14	—	50	105	0199001401 0199016051	—	Figure 15
<b>2643166851</b>	2	<b>26mm</b> 1.030	<b>38.1±1.0</b> 1.500	<b>26.65±0.75</b> 1.050	<b>25.4±0.75</b> 1.000	<b>6.35±0.25</b> .250	<b>0.85±0.2</b> .033	27	—	100	210	0199001401	—	Figure 16
<b>2631163851</b>	4	<b>26mm</b> 1.030	<b>38.1±1.0</b> 1.500	<b>26.65±0.75</b> 1.050	<b>25.4±0.75</b> 1.000	<b>12.05±0.4</b> .475	<b>1.9±0.4</b> .075	51	63	106	205	—	—	Figure 17
<b>2643163851</b>	4	<b>26mm</b> 1.030	<b>38.1±1.0</b> 1.500	<b>26.65±0.75</b> 1.050	<b>25.4±0.75</b> 1.000	<b>12.05±0.4</b> .475	<b>1.9±0.4</b> .075	51	—	95	195	—	—	Figure 18
2643172551	5	<b>27mm</b> 1.060	<b>33.5±0.65</b> 1.319	<b>27.0±0.5</b> 1.063	<b>8.0±0.4</b> .315	<b>6.5±0.25</b> .256	<b>1.25±0.7</b> .063	6.8	—	18	42	—	—	Figure 19
2643169351	4	<b>27mm</b> 1.060	<b>33.65±0.75</b> 1.325	<b>27.5±0.5</b> 1.083	<b>13.2±0.5</b> .520	<b>6.7±0.4</b> .265	<b>1.35±0.25</b> .053	12	—	31	65	—	—	Figure 20
2643167051	2^	<b>28mm</b> 1.080	<b>40.9±0.75</b> 1.600	<b>28.2±0.75</b> 1.100	<b>12.7±0.25</b> .500	<b>15.0±0.25</b> .590	<b>8.5±0.15</b> .335	23	—	46	88	—	—	Figure 21
2643166451	2	<b>28mm</b> 1.080	<b>38.35±1.0</b> 1.510	<b>27.95±1.0</b> 1.100	<b>28.6±0.7</b> 1.125	<b>9.0±0.3</b> .355	<b>3.3±0.25</b> .130	35	—	90	170	0199010301	—	Figure 22
2643168051	2^	<b>32mm</b> 1.280	<b>52.9±1.0</b> 2.083	<b>33.0±0.7</b> 1.299	<b>31.25±1.0</b> 1.230	<b>12.5±0.4</b> .492	<b>3.5±0.4</b> .138	84	—	133	243	—	—	Figure 23
2643167551	2^	<b>32mm</b> 1.280	<b>52.9±1.0</b> 2.083	<b>33.0±0.7</b> 1.299	<b>63.5±1.8</b> 2.500	<b>12.5±0.4</b> .492	<b>3.5±0.4</b> .138	170	—	260	460	—	—	Figure 24
2643170951	2	<b>34mm</b> 1.330	<b>45.1±0.75</b> 1.775	<b>34.4±0.7</b> 1.355	<b>12.7±0.4</b> .500	<b>6.35±0.25</b> .250	<b>0.85±0.2</b> .033	16	—	43	100	0199001401 0199016051	—	Figure 25
2643166551	4	<b>34mm</b> 1.330	<b>45.1±0.75</b> 1.775	<b>34.4±0.7</b> 1.355	<b>28.6±0.7</b> 1.125	<b>12.45±0.4</b> .490	<b>1.5±0.3</b> .060	71	—	95	195	—	0199166651	Figure 26
<b>2643166651</b>	2	<b>34mm</b> 1.330	<b>45.1±0.75</b> 1.775	<b>34.4±0.7</b> 1.355	<b>28.6±0.7</b> 1.125	<b>6.35±0.25</b> .250	<b>0.85±0.2</b> .033	36	—	96	225	0199001401 0199016551	0199166651	Figure 27
2643168251	2	<b>52mm</b> 2.030	<b>63.5±1.3</b> 2.500	<b>52.1±1.1</b> 2.050	<b>12.7±0.4</b> .500	<b>6.35±0.25</b> .250	<b>0.85±0.2</b> .033	22	—	39	104	0199001401 0199016051	—	Figure 28
<b>2631163951</b>	2	<b>52mm</b> 2.030	<b>63.5±1.3</b> 2.500	<b>52.1±1.1</b> 2.050	<b>28.6±0.8</b> 1.125	<b>6.35±0.25</b> .250	<b>0.85±0.2</b> .033	50	44	88	220	0199001401 0199016551	0199163951	Figure 29
<b>2643163951</b>	2	<b>52mm</b> 2.030	<b>63.5±1.3</b> 2.500	<b>52.1±1.1</b> 2.050	<b>28.6±0.8</b> 1.125	<b>6.35±0.25</b> .250	<b>0.85±0.2</b> .033	50	—	81	210	0199001401 0199016551	0199163951	Figure 30
2643167751	2	<b>65mm</b> 2.550	<b>76.2±1.5</b> 3.000	<b>65.3±1.3</b> 2.570	<b>12.7±0.4</b> .500	<b>6.35±0.25</b> .250	<b>0.85±0.2</b> .033	27	—	36	110	0199001401 0199016051	—	Figure 31
<b>2631164051</b>	2	<b>65mm</b> 2.550	<b>76.2±1.5</b> 3.000	<b>65.3±1.3</b> 2.570	<b>28.6±0.8</b> 1.125	<b>6.35±0.25</b> .250	<b>0.85±0.2</b> .033	60	40	81	225	0199001401 0199016551	0199164051	Figure 32
<b>2643164051</b>	2	<b>65mm</b> 2.550	<b>76.2±1.5</b> 3.000	<b>65.3±1.3</b> 2.570	<b>28.6±0.8</b> 1.125	<b>6.35±0.25</b> .250	<b>0.85±0.2</b> .033	60	—	75	215	0199001401 0199016551	0199164051	Figure 33
2643171151	2	<b>78mm</b> 3.060	<b>88.9±1.8</b> 3.500	<b>78.2±1.5</b> 3.080	<b>12.7±0.4</b> .500	<b>6.5±0.35</b> .256	<b>0.95±0.3</b> .037	31	—	33	95	0199001401 0199016051	—	Figure 34
2643168351	2	<b>78mm</b> 3.060	<b>88.9±1.8</b> 3.500	<b>78.2±1.5</b> 3.080	<b>28.6±0.8</b> 1.125	<b>6.5±0.35</b> .256	<b>0.95±0.3</b> .037	70	—	75	215	0199001401 0199016551	—	Figure 35

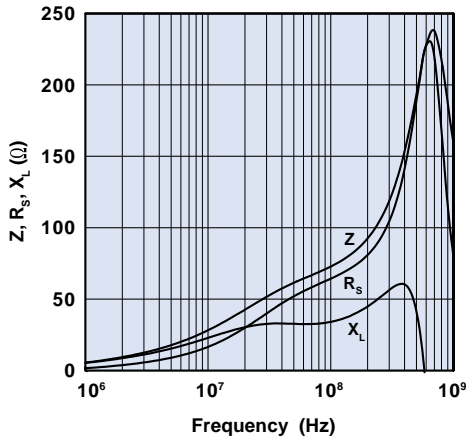
\* This dimension may be modified to suit specific applications.

^ Part does not have clip slots as shown in figure.

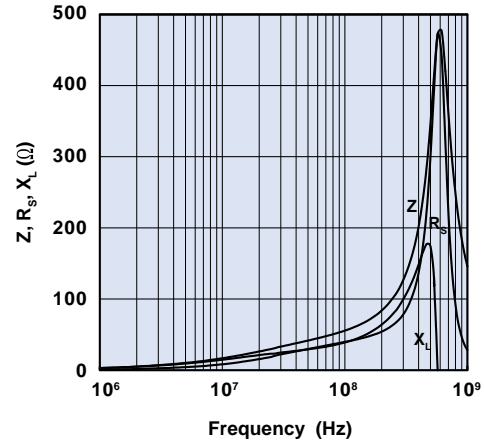
\*\* Bold part numbers designate preferred parts.

<sup>1</sup> Guaranteed Z Min is Z Typ -20%

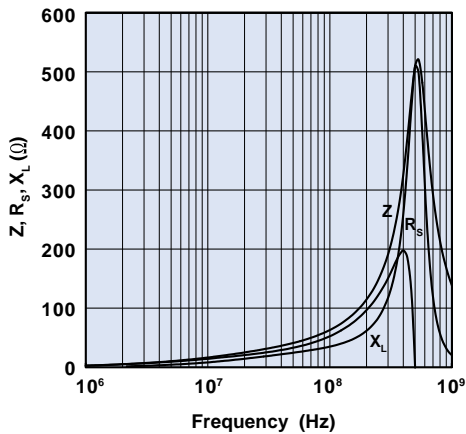
# Flat Cable EMI Suppression Cores



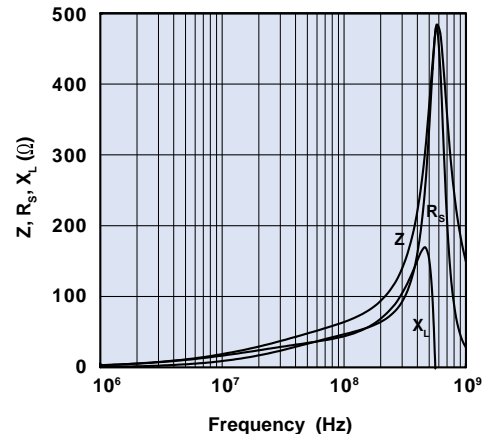
**Figure 6** Impedance, reactance, and resistance vs. frequency for flat cable EMI suppression core 2643171351.



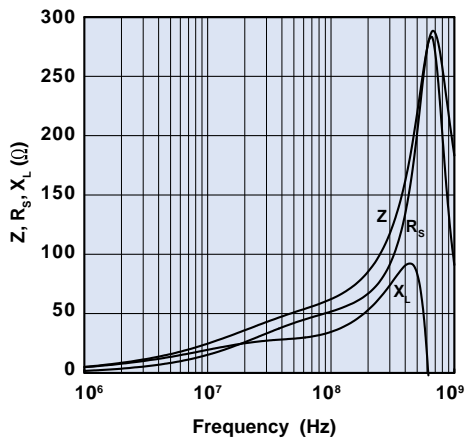
**Figure 7** Impedance, reactance, and resistance vs. frequency for flat cable EMI suppression core 2643172751.



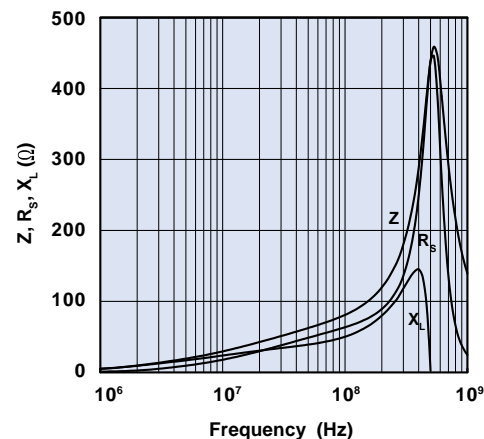
**Figure 8** Impedance, reactance, and resistance vs. frequency for flat cable EMI suppression core 2643173851.



**Figure 9** Impedance, reactance, and resistance vs. frequency for flat cable EMI suppression core 2643170251.

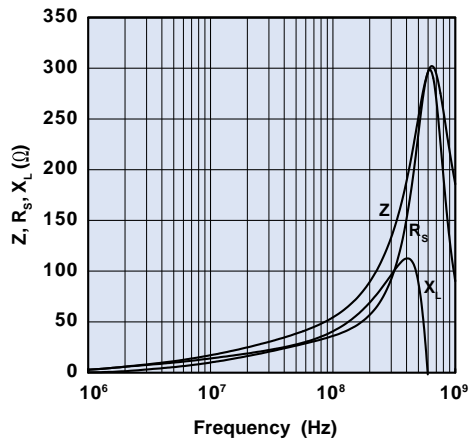


**Figure 10** Impedance, reactance, and resistance vs. frequency for flat cable EMI suppression core 2643169551.

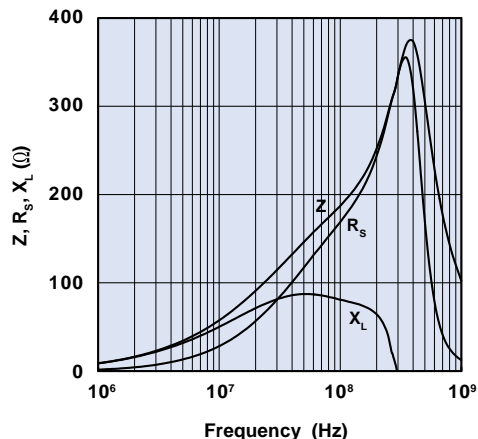


**Figure 11** Impedance, reactance, and resistance vs. frequency for flat cable EMI suppression core 2643168751.

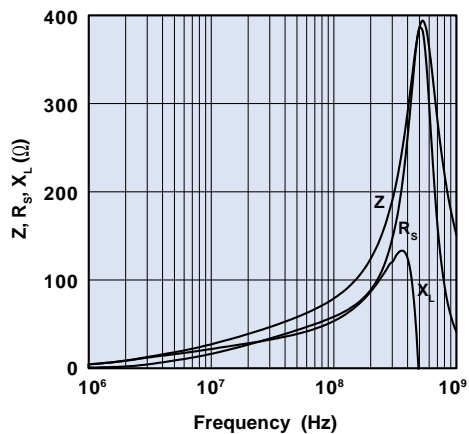
# Flat Cable EMI Suppression Cores



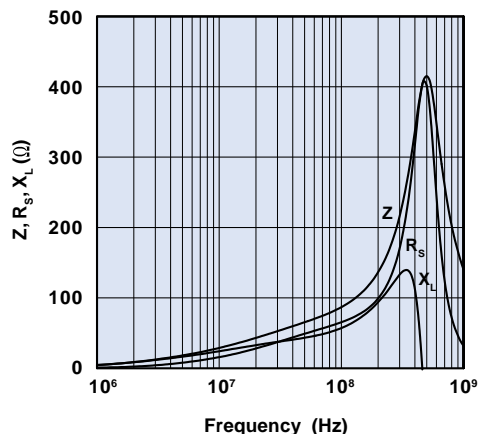
**Figure 12** Impedance, reactance, and resistance vs. frequency for flat cable EMI suppression core 2643173351.



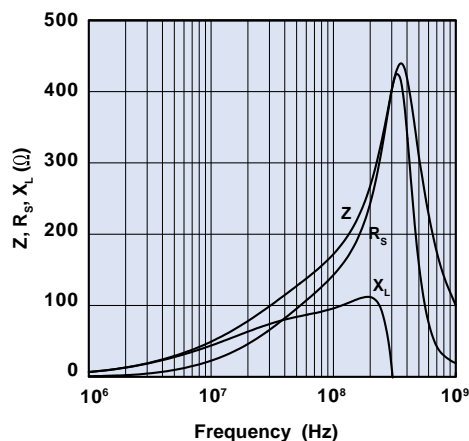
**Figure 13** Impedance, reactance, and resistance vs. frequency for flat cable EMI suppression core 2643168651.



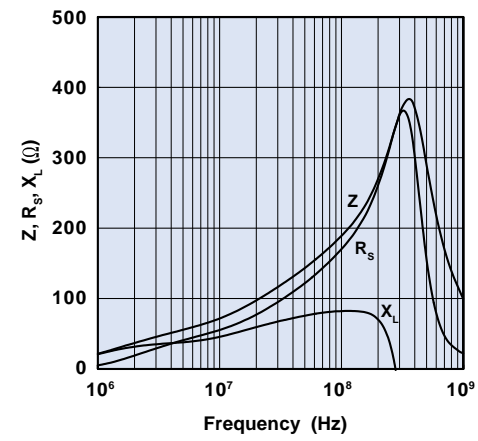
**Figure 14** Impedance, reactance, and resistance vs. frequency for flat cable EMI suppression core 2643164551.



**Figure 15** Impedance, reactance, and resistance vs. frequency for flat cable EMI suppression core 2643171051.

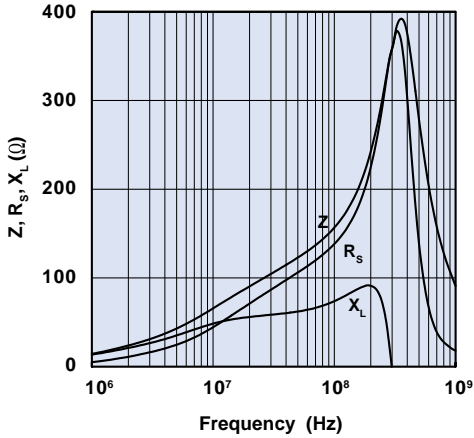


**Figure 16** Impedance, reactance, and resistance vs. frequency for flat cable EMI suppression core 2643166851.

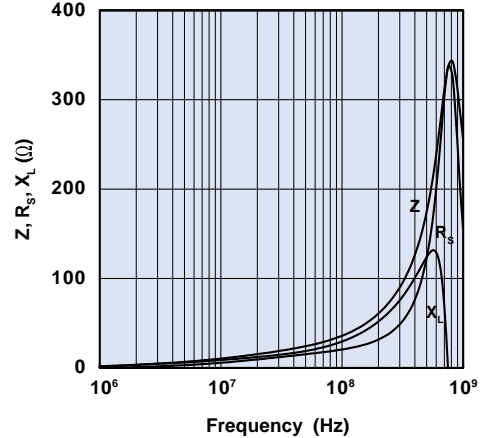


**Figure 17** Impedance, reactance, and resistance vs. frequency for flat cable EMI suppression core 2631163851.

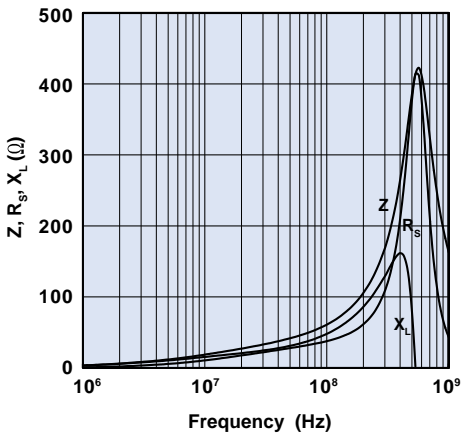
# Flat Cable EMI Suppression Cores



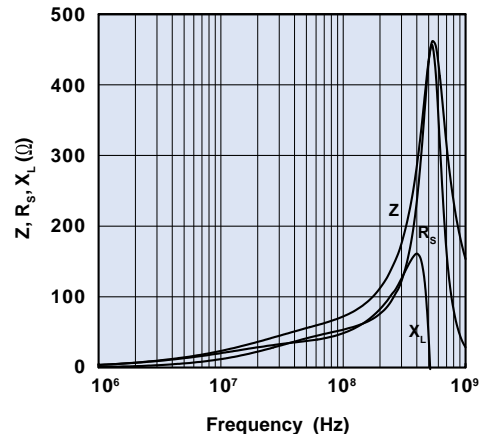
**Figure 18** Impedance, reactance, and resistance vs. frequency for flat cable EMI suppression core 2643163851.



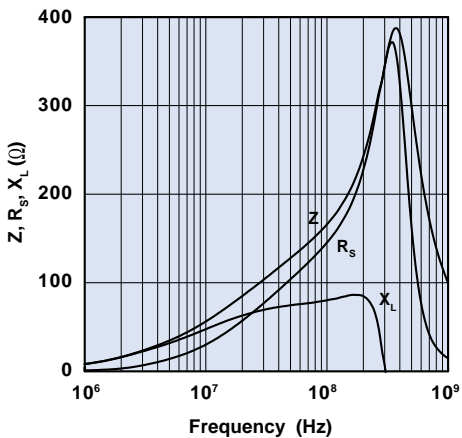
**Figure 19** Impedance, reactance, and resistance vs. frequency for flat cable EMI suppression core 2643172551.



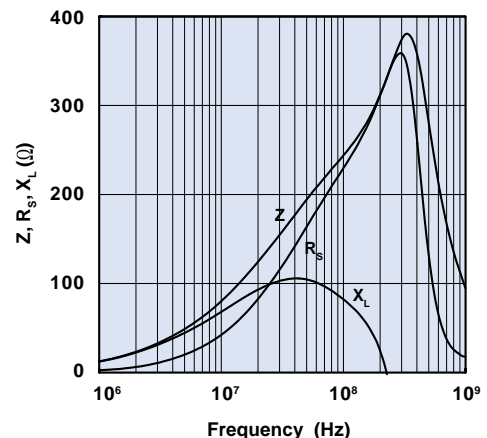
**Figure 20** Impedance, reactance, and resistance vs. frequency for flat cable EMI suppression core 2643169351.



**Figure 21** Impedance, reactance, and resistance vs. frequency for flat cable EMI suppression core 2643167051.



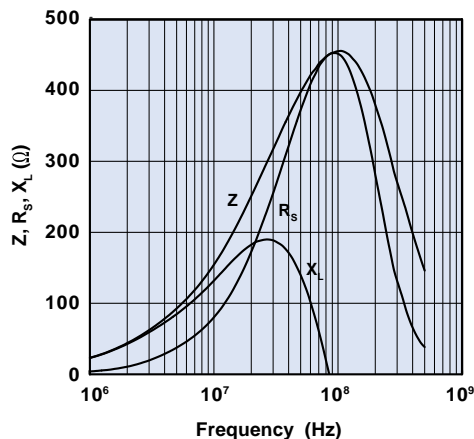
**Figure 22** Impedance, reactance, and resistance vs. frequency for flat cable EMI suppression core 2643166451.



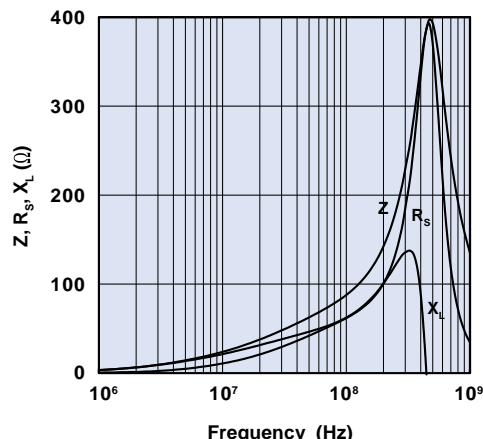
**Figure 23** Impedance, reactance, and resistance vs. frequency for flat cable EMI suppression core 2643168051.



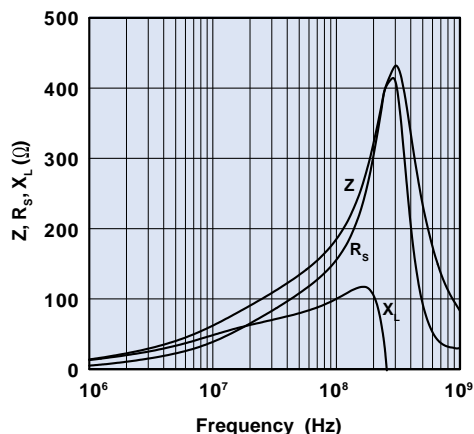
# Flat Cable EMI Suppression Cores



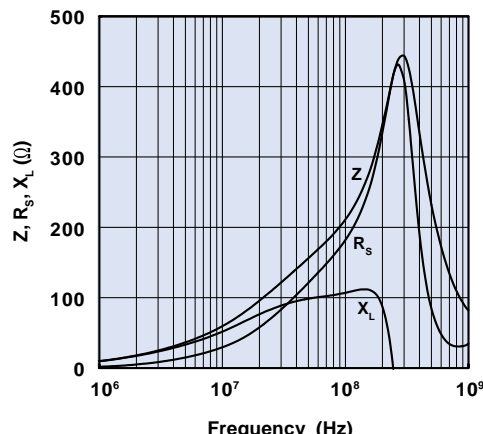
**Figure 24** Impedance, reactance, and resistance vs. frequency for flat cable EMI suppression core 2643167551.



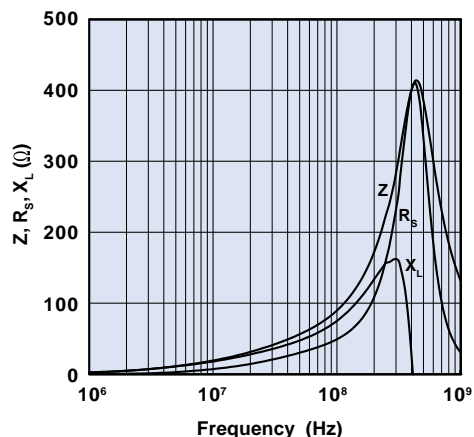
**Figure 25** Impedance, reactance, and resistance vs. frequency for flat cable EMI suppression core 2643170951.



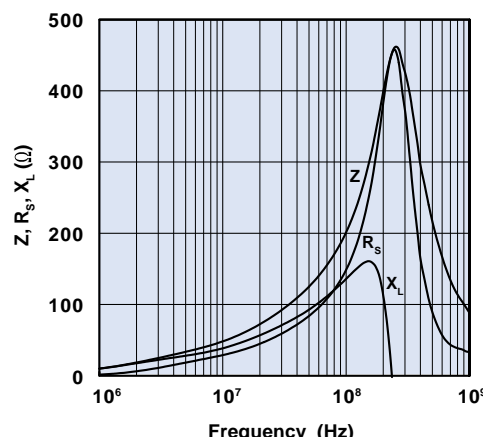
**Figure 26** Impedance, reactance, and resistance vs. frequency for flat cable EMI suppression core 2643166551.



**Figure 27** Impedance, reactance, and resistance vs. frequency for flat cable EMI suppression core 2643166651.

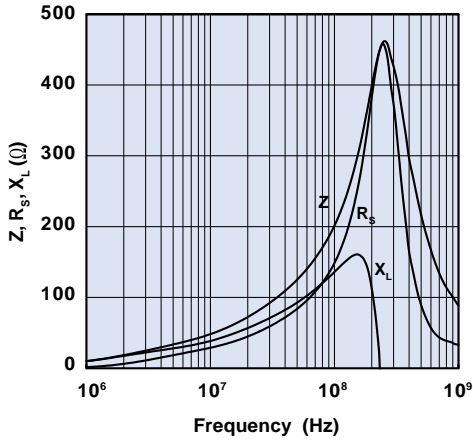


**Figure 28** Impedance, reactance, and resistance vs. frequency for flat cable EMI suppression core 2643168251.

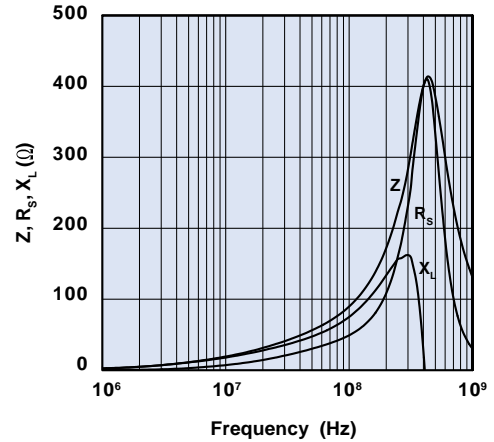


**Figure 29** Impedance, reactance, and resistance vs. frequency for flat cable EMI suppression core 2631163951.

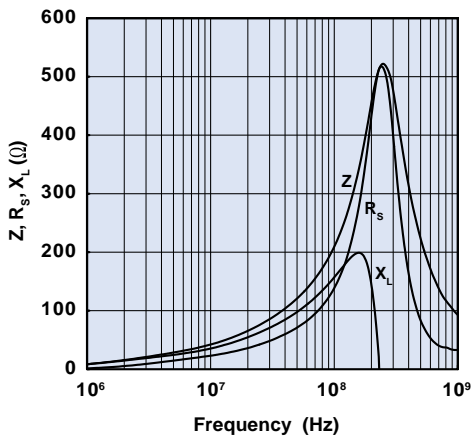
# Flat Cable EMI Suppression Cores



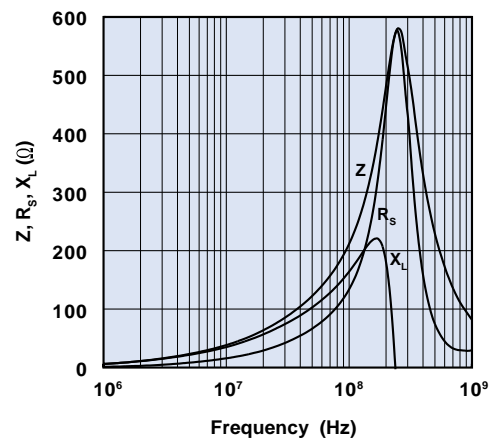
**Figure 30** Impedance, reactance, and resistance vs. frequency for flat cable EMI suppression core 2643163951.



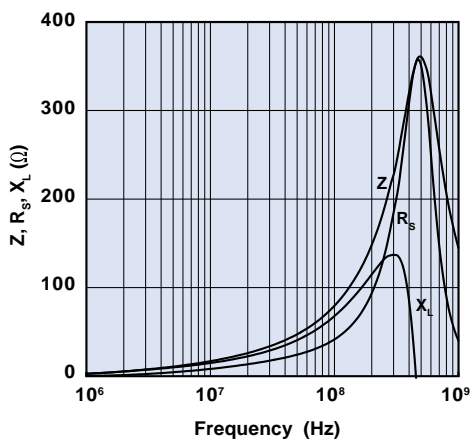
**Figure 31** Impedance, reactance, and resistance vs. frequency for flat cable EMI suppression core 2643167751.



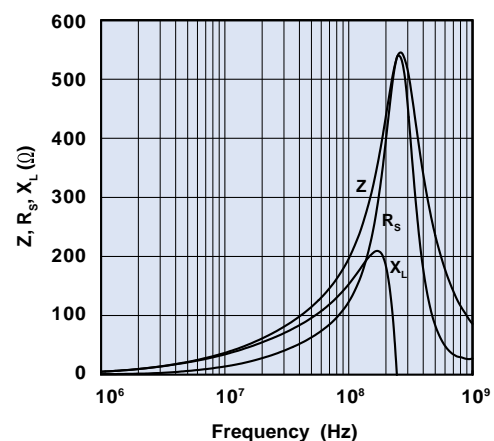
**Figure 32** Impedance, reactance, and resistance vs. frequency for flat cable EMI suppression core 2631164051.



**Figure 33** Impedance, reactance, and resistance vs. frequency for flat cable EMI suppression core 2643164051.



**Figure 34** Impedance, reactance, and resistance vs. frequency for flat cable EMI suppression core 2643171151.



**Figure 35** Impedance, reactance, and resistance vs. frequency for flat cable EMI suppression core 2643168351.

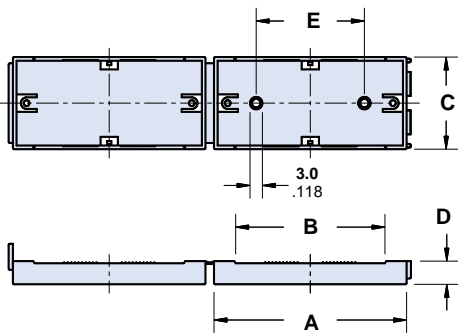
# Flat Cable EMI Suppression Cores

## Cases and Clips

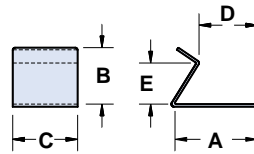
Fair-Rite offers polypropylene cases and steel and polypropylene clips to assist in the assembly of the split cable core halves.

For Flat Cable Snap-its, see pages 116 and 117.

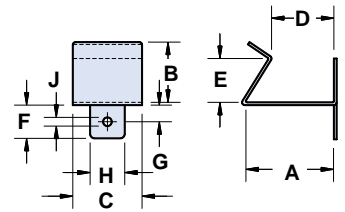
- Figure 1 cases are polypropylene with a flammability rating of UL94-V0.
- Figure 2 and Figure 3 clips are **0.5mm (.020")** high carbon steel with a zinc electroplate finish.
- Figure 4 clips are polypropylene with a flammability rating of UL94-V0.



**Figure 1**  
Case has rows of serrated teeth that grip and center the core around the cable (Patented).



**Figure 2**

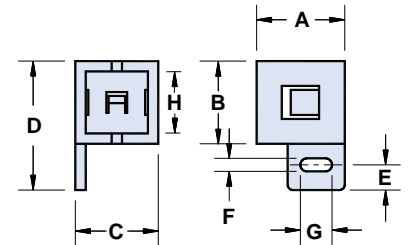


**Figure 3**

## Cases

**Dimensions** (Bold numbers are in millimeters, light numbers are nominal in inches.)

Part Number Case	Fig.	A	B	C	D	E
<b>0199166651</b>	1	<b>49.5</b> 1.950	<b>34.4</b> 1.350	<b>32.3</b> 1.272	<b>8.1</b> .320	<b>20.0</b> .787
<b>0199163951</b>	1	<b>67.8</b> 2.670	<b>52.1</b> 2.051	<b>32.3</b> 1.272	<b>8.1</b> .320	<b>38.0</b> 1.496
<b>0199164051</b>	1	<b>80.8</b> 3.180	<b>65.3</b> 2.570	<b>32.3</b> 1.272	<b>8.1</b> .320	<b>50.8</b> 2.000



**Figure 4**

## Clips

**Dimensions** (Bold numbers are in millimeters, light numbers are nominal in inches.)

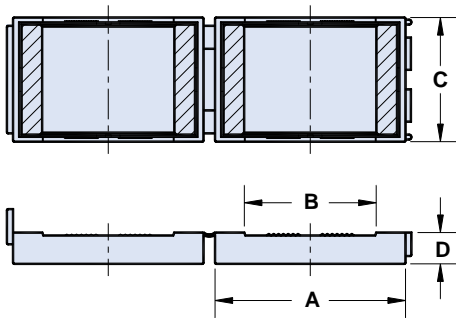
Part Number Clip	Fig.	A	B	C	D	E	F	G	H	J
<b>0199001401</b>	2	<b>16.1</b> .635	<b>11.0</b> .433	<b>12.7</b> .500	<b>11.4</b> .450	<b>8.0</b> .315	—	—	—	—
<b>0199010301</b>	3	<b>21.2</b> .835	<b>11.0</b> .433	<b>12.7</b> .500	<b>16.5</b> .650	<b>8.0</b> .315	<b>7.5</b> .295	<b>4.0</b> .157	<b>6.0</b> .236	<b>3.0</b> .118
<b>0199016051</b>	4	<b>16.7</b> .657	<b>15.9</b> .626	<b>15.9</b> .626	<b>24.6</b> .969	<b>4.4</b> .171	<b>3.2</b> .126	<b>6.4</b> .252	<b>13.1</b> .516	—
<b>0199016551</b>	4	<b>16.7</b> .657	<b>32.2</b> 1.27	<b>15.9</b> .626	<b>40.5</b> 1.59	<b>4.4</b> .171	<b>3.2</b> .126	<b>6.4</b> .252	<b>29.5</b> 1.161	—

# Flat Cable Snap-its

Flat Cable Snap-its can accommodate flat cable widths up to 2.550 inches. These parts are available in 31 and 43 material which can suppress frequencies up to 500 MHz.

The polypropylene case has a flammability rating of UL 94-V0.

- Cores are controlled for impedance limits only. They are tested for impedance with a single turn, using a Hewlett Packard HP 4193A Vector Impedance Meter.
- For impedance vs. frequency curves for these parts, see Figures 1-6.
- For any flat cable snap-it requirement not listed in the catalog, please contact our customer service group for availability and pricing.
- The Expanded Cable and Connector EMI Suppressor Kit (part number 0199000005) contains a selection of these suppression cores. See page 92.

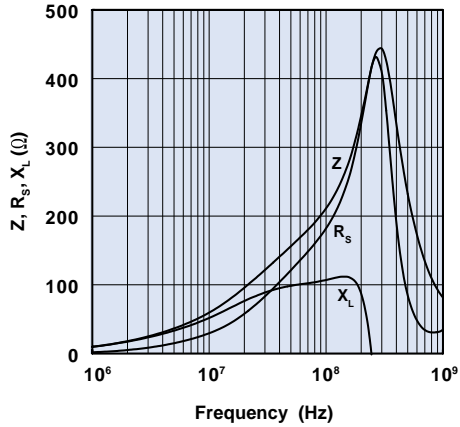


Dimensions (Bold numbers are in millimeters, light numbers are nominal in inches.)

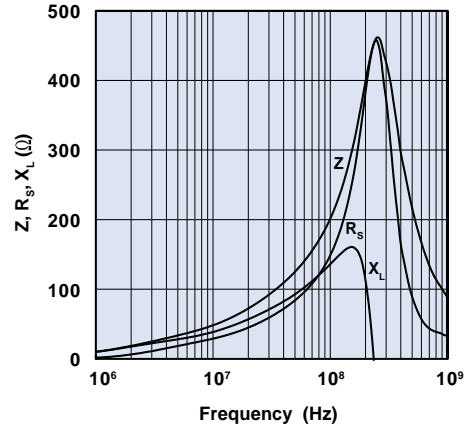
Part Number	Cable Width	A	B	C	D	Typical Impedance( $\Omega$ ) <sup>1</sup>			Z, R <sub>s</sub> , X <sub>L</sub> vs. Frequency Curve
						10 MHz	25 MHz	100 MHz	
0443166651	<b>34 Max.</b> 1.330 Max.	<b>49.5</b> 1.950	<b>34.4</b> 1.350	<b>32.3</b> 1.272	<b>8.1</b> .320	—	96	225	Figure 1
0431163951	<b>52 Max.</b> 2.030 Max.	<b>67.8</b> 2.670	<b>52.1</b> 2.050	<b>32.3</b> 1.272	<b>8.1</b> .320	44	94	235	Figure 2
0443163951	<b>52 Max.</b> 2.030 Max.	<b>67.8</b> 2.670	<b>52.1</b> 2.050	<b>32.3</b> 1.272	<b>8.1</b> .320	—	88	225	Figure 3
0431164051	<b>65 Max.</b> 2.550 Max.	<b>80.8</b> 3.180	<b>65.3</b> 2.570	<b>32.3</b> 1.272	<b>8.1</b> .320	40	81	225	Figure 4
0443164051	<b>65 Max.</b> 2.550 Max.	<b>80.8</b> 3.180	<b>65.3</b> 2.570	<b>32.3</b> 1.272	<b>8.1</b> .320	—	75	215	Figure 5

<sup>1</sup> Guaranteed Z Min is Z Typ -20%

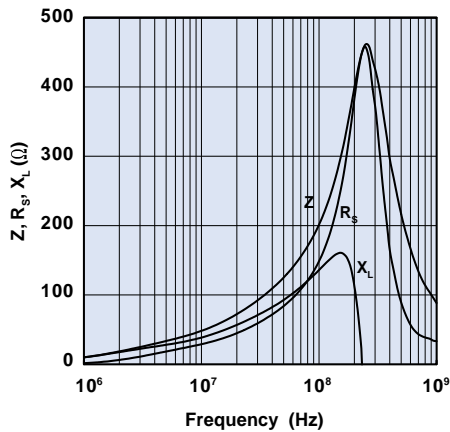
# Flat Cable Snap-its



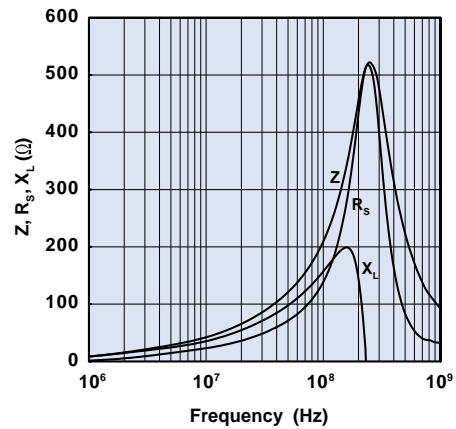
**Figure 1** Impedance, reactance, and resistance vs. frequency curve for flat cable snap-it 0443166651.



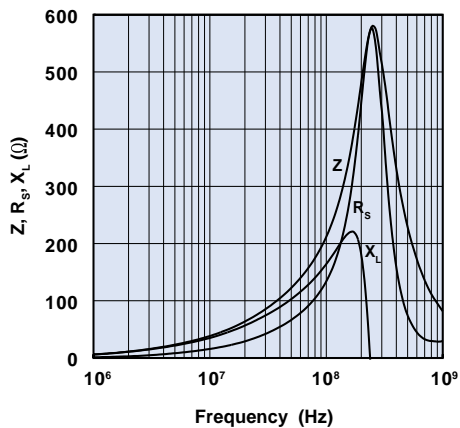
**Figure 2** Impedance, reactance, and resistance vs. frequency curve for flat cable snap-it 0431163951.



**Figure 3** Impedance, reactance, and resistance vs. frequency curve for flat cable snap-it 0443163951.



**Figure 4** Impedance, reactance, and resistance vs. frequency curve for flat cable snap-it 0431164051.



**Figure 5** Impedance, reactance, and resistance vs. frequency curve for flat cable snap-it 0443164051.

# Miscellaneous Suppression Cores

Fair-Rite has tooled several special core geometries for use as EMI attenuators.

- Cores are controlled for impedance limits only. They are tested for impedance with a single turn, using a Hewlett Packard HP4193A Vector Impedance Meter.
- For impedance vs. frequency curves for these parts, see Figures 5-8.
- For any suppression core requirement not listed in the catalog, please contact our customer service group for availability and pricing.

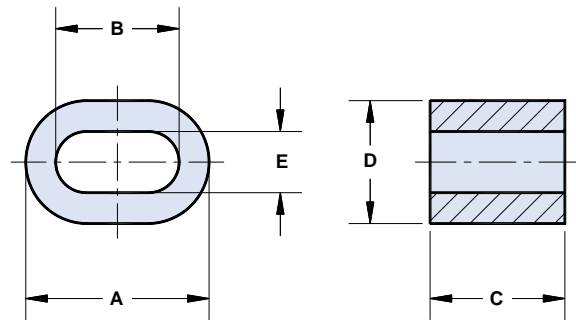


Figure 1

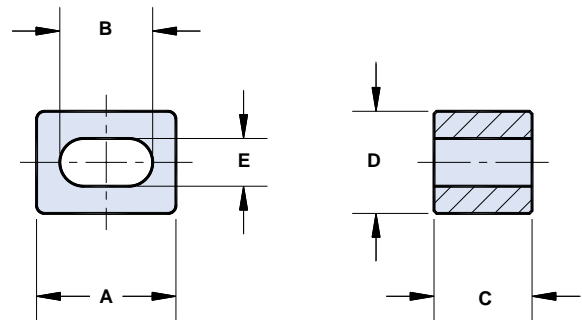


Figure 2

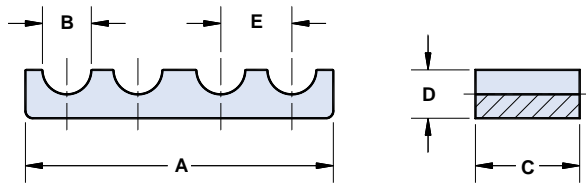


Figure 3

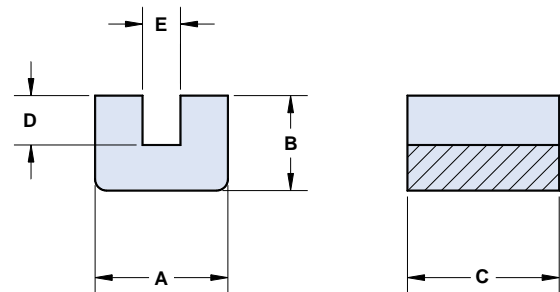


Figure 4

Dimensions (Bold numbers are in millimeters, light numbers are nominal in inches.)

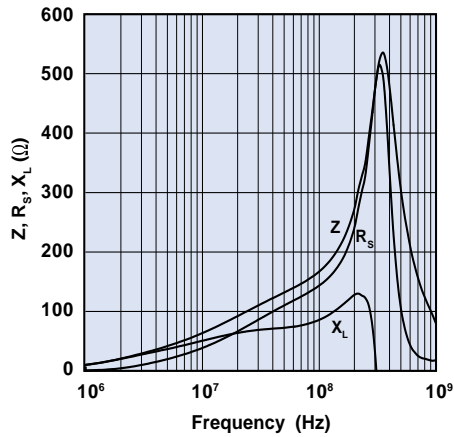
Typical Impedance( $\Omega$ )<sup>1</sup>

Part Number	Fig.	A	B	C*	D	E	Wt (g)	25 MHz	100 MHz	Z, R <sub>s</sub> , X <sub>L</sub> vs. Frequency Curve
2643167851	1	<b>38.85±0.75</b> 1.530	<b>26.15±0.75</b> 1.030	<b>28.6±0.7</b> 1.125	<b>26.0±0.6</b> 1.025	<b>12.95±0.25</b> .510	85	94	169	Figure 5
2643166251	2	<b>26.7±0.7</b> 1.052	<b>17.8±0.5</b> .701	<b>18.8±0.4</b> .740	<b>19.5±0.5</b> .770	<b>9.15±0.50</b> .360	34	75	120	Figure 6
2643165151	3	<b>82.6±1.6</b> 3.250	<b>13.1±0.3</b> .516	<b>28.0±0.7</b> 1.100	<b>12.95±0.25</b> .510	<b>19.05±0.4</b> .750	109	163	280	Figure 7
2643175451	4	<b>17.8±0.4</b> .700	<b>12.7±0.5</b> .500	<b>20.32±0.5</b> .800	<b>6.6±0.25</b> .260	<b>5.08±0.25</b> .200	19	119	180	Figure 8

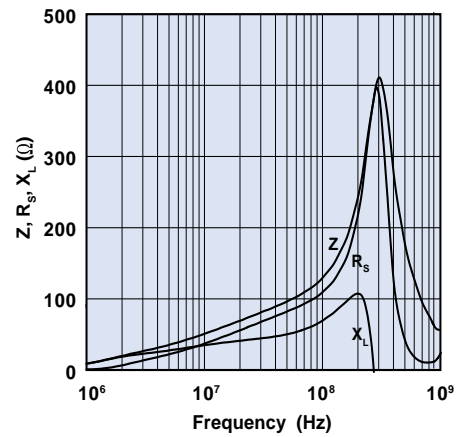
\*This dimension may be modified to suit specific applications.

<sup>1</sup>Guaranteed Z Min is Z Typ -20%

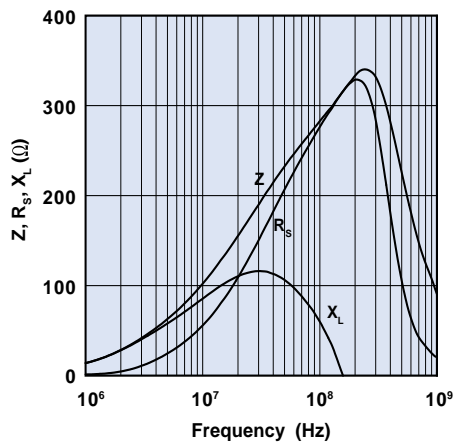
# Miscellaneous Suppression Cores



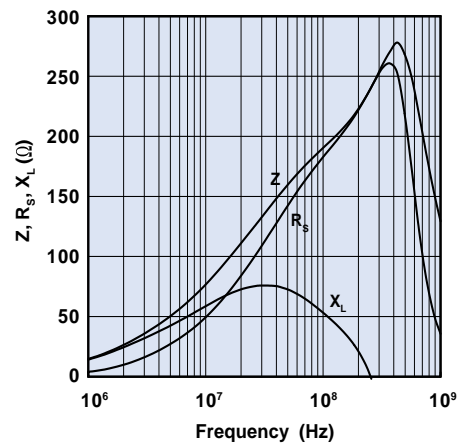
**Figure 5** Impedance, reactance, and resistance vs. frequency curve for suppression core 2643167851.



**Figure 6** Impedance, reactance, and resistance vs. frequency curve for suppression core 2643166251



**Figure 7** Impedance, reactance, and resistance vs. frequency curve for suppression core 2643165151.



**Figure 8** Impedance, reactance, and resistance vs. frequency curve for suppression core 2643175451.

# Connector EMI Suppression Plates

To reduce conducted EMI, "D" type and other types of suppression plates are available in several sizes and pin layouts.

- Impedance specification applies to all holes. They are tested for impedance with a single turn, using a Hewlett Packard HP 4193A Vector Impedance Meter.
- For impedance vs. frequency curves for these parts, please see Figures 7-21.
- For any connector EMI suppression plate requirement not listed in the catalog, feel free to contact our customer service group for availability and pricing.
- The Expanded Cable and Connector EMI Suppressor Kit (part number 0199000005) and the Connector EMI Suppression Plate Kit (0199000020) contain a selection of these cores. See page 92.

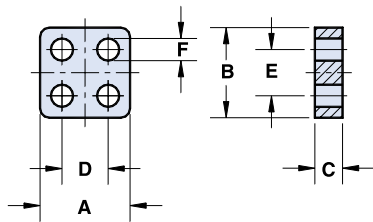


Figure 1

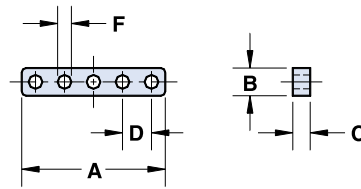


Figure 2

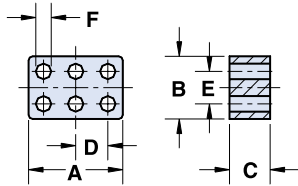


Figure 3

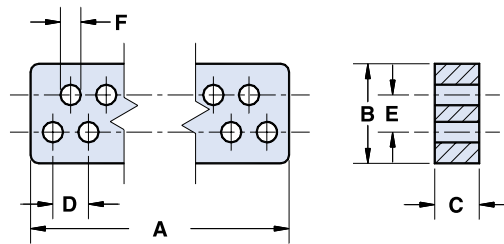


Figure 4

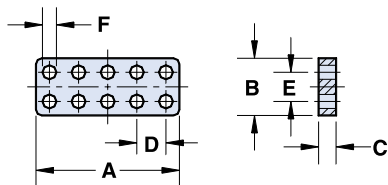


Figure 5

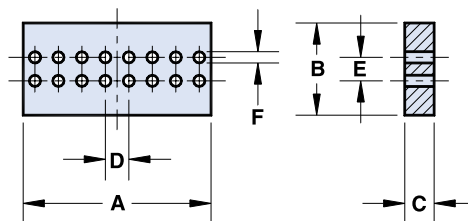


Figure 6



# Connector EMI Suppression Plates

Dimensions (Bold numbers are in millimeters, light numbers are nominal in inches.)

Typical Impedance( $\Omega$ )<sup>1</sup>

Part Number**	Figure	Number of Holes	Number of Rows	A	B	C*	D	E	F	Wt (g)	25 MHz	100 MHz	Z, R <sub>s</sub> , X <sub>i</sub> vs. Frequency Curve
2644246001	1	4	2	<b>3.86±0.10</b> .152	<b>3.86±0.10</b> .152	<b>1.52±0.13</b> .060	<b>2.00±0.08</b> .079	<b>2.00±0.08</b> .079	<b>0.82±0.1</b> .034	.10	14	28	Figure 7
2644246101	1	4	2	<b>3.86±0.10</b> .152	<b>3.86±0.10</b> .152	<b>6.35±0.13</b> .250	<b>2.00±0.08</b> .079	<b>2.00±0.08</b> .079	<b>0.82±0.1</b> .034	.38	46	73	Figure 8
2644245901	1	4	2	<b>4.90±0.10</b> .193	<b>4.90±0.10</b> .193	<b>1.52±0.13</b> .060	<b>2.54±0.13</b> .100	<b>2.54±0.10</b> .100	<b>1.22±0.07</b> .048	.15	13	28	Figure 9
2644245601	1	4	2	<b>4.90±0.10</b> .193	<b>4.90±0.10</b> .193	<b>6.35±0.13</b> .250	<b>2.54±0.13</b> .100	<b>2.54±0.10</b> .100	<b>1.22±0.07</b> .048	.60	41	66	Figure 10
2644246701	2	5	1	<b>12.52±0.13</b> .493	<b>2.54 Max.</b> .100 Max.	<b>1.52±0.13</b> .060	<b>2.54±0.13</b> .100	—	<b>1.22±0.07</b> .048	.18	13	28	Figure 9
2644246801	2	5	1	<b>12.52±0.13</b> .493	<b>2.54 Max.</b> .100 Max.	<b>3.05±0.13</b> .120	<b>2.54±0.13</b> .100	—	<b>1.22±0.07</b> .048	.35	20	36	Figure 11
2644246901	2	5	1	<b>12.52±0.13</b> .493	<b>2.54 Max.</b> .100 Max.	<b>6.10±0.13</b> .240	<b>2.54±0.13</b> .100	—	<b>1.22±0.07</b> .048	.70	38	59	Figure 12
2644246201	3	6	2	<b>5.86±0.10</b> .231	<b>3.86±0.10</b> .152	<b>1.52±0.13</b> .060	<b>2.00±0.08</b> .079	<b>2.00±0.08</b> .079	<b>0.82±0.1</b> .034	.14	14	28	Figure 7
2644246301	3	6	2	<b>5.86±0.10</b> .231	<b>3.86±0.10</b> .152	<b>6.35±0.13</b> .250	<b>2.00±0.08</b> .079	<b>2.00±0.08</b> .079	<b>0.82±0.1</b> .034	.60	46	73	Figure 8
2644245701	3	6	2	<b>7.44±0.10</b> .293	<b>4.90±0.10</b> .193	<b>1.52±0.13</b> .060	<b>2.54±0.13</b> .100	<b>2.54±0.10</b> .100	<b>1.22±0.07</b> .048	.22	13	28	Figure 9
2644245801	3	6	2	<b>7.44±0.10</b> .293	<b>4.90±0.10</b> .193	<b>6.35±0.13</b> .250	<b>2.54±0.13</b> .100	<b>2.54±0.10</b> .100	<b>1.22±0.07</b> .048	.94	41	66	Figure 10
2644236101	4	9	2	<b>14.40±0.15</b> .567	<b>7.75-0.25</b> .300	<b>3.43±0.13</b> .135	<b>2.75±0.13</b> .108	<b>2.85±0.13</b> .112	<b>1.60±0.08</b> .062	1.6	30	51	Figure 13
2644236401	4	9	2	<b>14.40±0.15</b> .567	<b>7.75-0.25</b> .300	<b>6.86±0.13</b> .270	<b>2.75±0.13</b> .108	<b>2.85±0.13</b> .112	<b>1.60±0.08</b> .062	3.2	56	91	Figure 14
2644247301	5	10	2	<b>6.22±0.10</b> .245	<b>3.30±0.10</b> .130	<b>1.52±0.13</b> .060	<b>1.27±0.10</b> .050	<b>1.27±0.08</b> .050	<b>0.69±0.05</b> .027	.08	13	28	Figure 15
2644247401	5	10	2	<b>6.22±0.10</b> .245	<b>3.30±0.10</b> .130	<b>3.05±0.13</b> .120	<b>1.27±0.10</b> .050	<b>1.27±0.08</b> .050	<b>0.69±0.05</b> .027	.17	24	41	Figure 16
2644247501	5	10	2	<b>6.22±0.10</b> .245	<b>3.30±0.10</b> .130	<b>6.10±0.13</b> .240	<b>1.27±0.10</b> .050	<b>1.27±0.08</b> .050	<b>0.69±0.05</b> .027	.34	41	65	Figure 17
2644247001	5	10	2	<b>12.52±0.13</b> .493	<b>4.90±0.10</b> .193	<b>1.52±0.13</b> .060	<b>2.54±0.13</b> .100	<b>2.54±0.10</b> .100	<b>1.22±0.07</b> .048	.37	13	28	Figure 9
2644247101	5	10	2	<b>12.52±0.13</b> .493	<b>4.90±0.10</b> .193	<b>3.05±0.13</b> .120	<b>2.54±0.13</b> .100	<b>2.54±0.10</b> .100	<b>1.22±0.07</b> .048	.74	23	40	Figure 18
2644247201	5	10	2	<b>12.52±0.13</b> .493	<b>4.90±0.10</b> .193	<b>6.10±0.13</b> .240	<b>2.54±0.13</b> .100	<b>2.54±0.10</b> .100	<b>1.22±0.07</b> .048	1.5	40	64	Figure 19
2644236301	4	15	2	<b>22.55±0.25</b> .888	<b>7.75-0.25</b> .300	<b>3.43±0.13</b> .135	<b>2.75±0.13</b> .108	<b>2.85±0.13</b> .112	<b>1.60±0.08</b> .062	2.4	30	51	Figure 13
2644236501	4	15	2	<b>22.55±0.25</b> .888	<b>7.75-0.25</b> .300	<b>6.86±0.13</b> .270	<b>2.75±0.13</b> .108	<b>2.85±0.13</b> .112	<b>1.60±0.08</b> .062	4.9	56	91	Figure 14
2644373941	6	16	2	<b>21.60±0.25</b> .850	<b>11.65-0.40</b> .451	<b>1.52±0.13</b> .060	<b>2.54±0.13</b> .100	<b>7.62±0.15</b> .300	<b>1.00±0.15</b> .042	2.9	19	36	Figure 20
2644373841	6	16	2	<b>20.30±0.25</b> .800	<b>10.15-0.40</b> .392	<b>3.18±0.13</b> .125	<b>2.54±0.13</b> .100	<b>2.54±0.10</b> .100	<b>1.22±0.07</b> .048	2.8	30	51	Figure 21
2644236001	4	25	2	<b>36.3±0.4</b> 1.430	<b>7.75-0.25</b> .300	<b>3.43±0.13</b> .135	<b>2.75±0.13</b> .108	<b>2.85±0.13</b> .112	<b>1.60±0.08</b> .062	3.6	30	51	Figure 13
2644236601	4	25	2	<b>36.3±0.4</b> 1.430	<b>7.75-0.25</b> .300	<b>6.86±0.13</b> .270	<b>2.75±0.13</b> .108	<b>2.85±0.13</b> .112	<b>1.60±0.08</b> .062	7.2	56	91	Figure 14
2644251801	4	37	2	<b>52.8±0.7</b> 2.079	<b>7.75-0.25</b> .300	<b>3.43±0.13</b> .135	<b>2.75±0.13</b> .108	<b>2.85±0.13</b> .112	<b>1.60±0.08</b> .062	5.4	30	51	Figure 13
2644251901	4	37	2	<b>52.8±0.7</b> 2.079	<b>7.75-0.25</b> .300	<b>6.86±0.13</b> .270	<b>2.75±0.13</b> .108	<b>2.85±0.13</b> .112	<b>1.60±0.08</b> .062	11	56	91	Figure 14

\* This dimension may be modified to suit specific applications.

\*\* Bold part numbers designate preferred parts.

<sup>1</sup> Guaranteed Z Min is Z Typ -20%

P.O. Box J, One Commercial Row, Wallkill, NY 12589-0288

Fair-Rite Products Corp.

Phone: (888) FAIR RITE / (845) 895-2055 • FAX: (888) FERRITE / (845) 895-2629 • www.fair-rite.com • E-Mail: ferrites@fair-rite.com  
(888) 324-7748 (888) 337-7483 Note: (914) Area Code has changed to (845).

# Connector EMI Suppression Plates

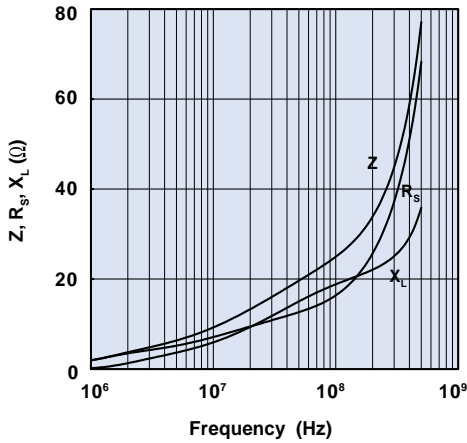


Figure 7 Impedance vs. Frequency for connector EMI suppression plate 2644246001 and 2644246201.

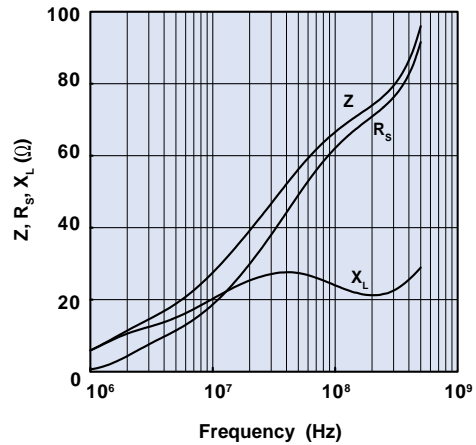


Figure 8 Impedance vs. Frequency for connector EMI suppression plate 2644246101 and 2644246301.

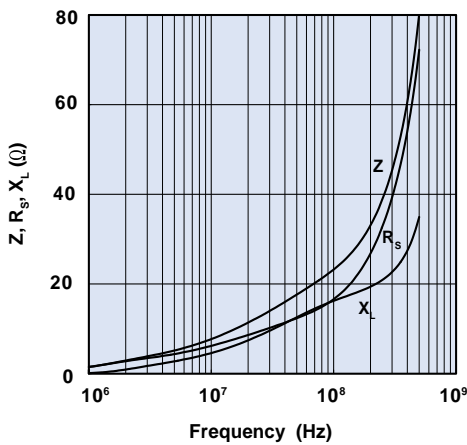


Figure 9 Impedance vs. Frequency for connector EMI suppression plate 2644245901, 2644246701, 2644245701 and 2644247001.

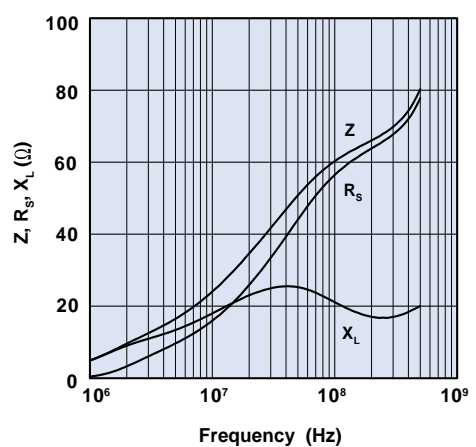


Figure 10 Impedance vs. Frequency for connector EMI suppression plate 2644245601 and 2644245801.

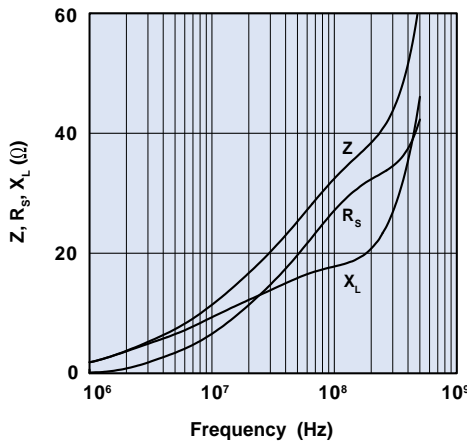


Figure 11 Impedance vs. Frequency for connector EMI suppression plate 2644246801.

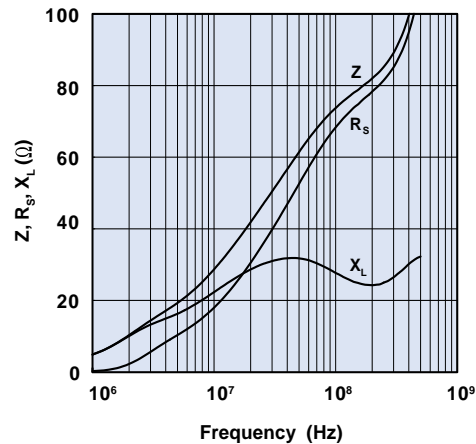
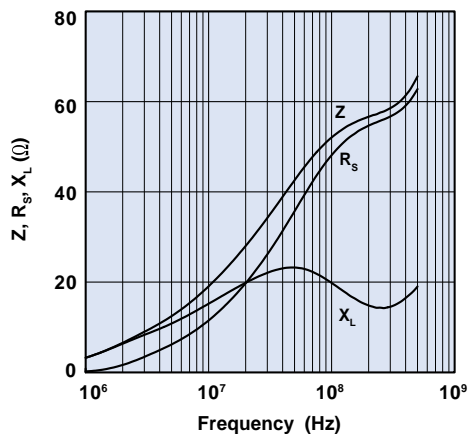
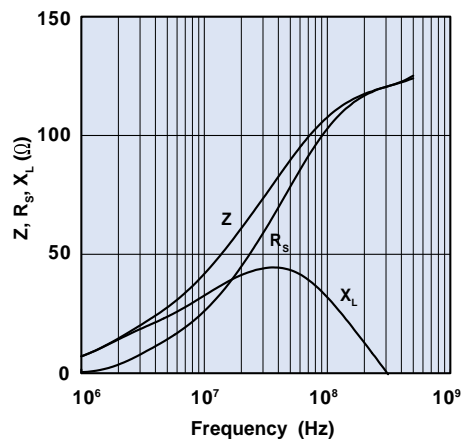


Figure 12 Impedance vs. Frequency for connector EMI suppression plate 2644246901.

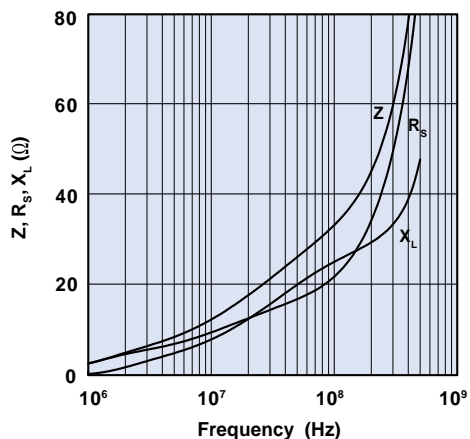
# Connector EMI Suppression Plates



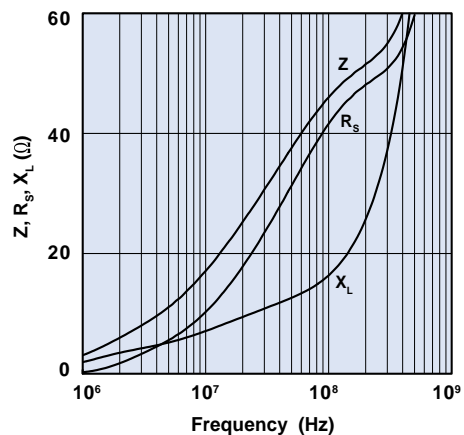
**Figure 13** Impedance vs. Frequency for connector EMI suppression plate 2644236101, 2644236301, 2644236001 and 2644251801.



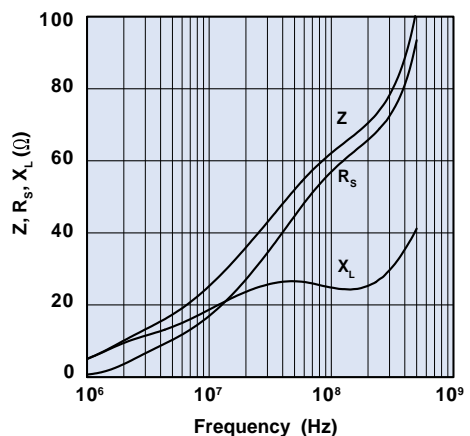
**Figure 14** Impedance vs. Frequency for connector EMI suppression plate 2644236401, 2644236501, 2644236601 and 2644251901.



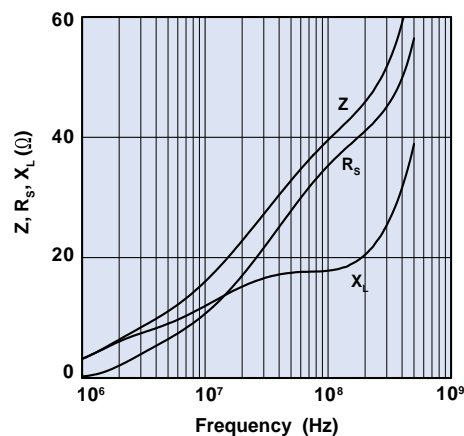
**Figure 15** Impedance vs. Frequency for connector EMI suppression plate 2644247301.



**Figure 16** Impedance vs. Frequency for connector EMI suppression plate 2644247401.



**Figure 17** Impedance vs. Frequency for connector EMI suppression plate 2644247501.



**Figure 18** Impedance vs. Frequency for connector EMI suppression plate 2644247101.

# Connector EMI Suppression Plates

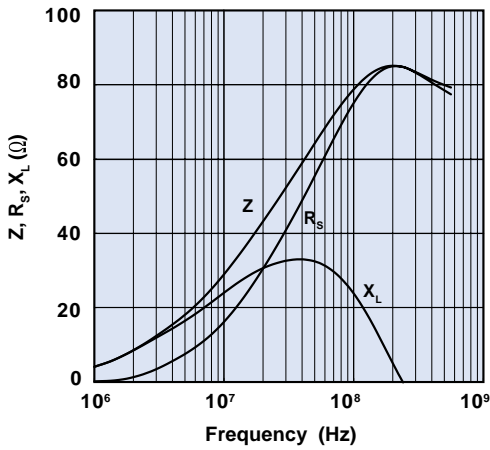


Figure 19 Impedance vs. Frequency for connector EMI suppression plate 2644247201.

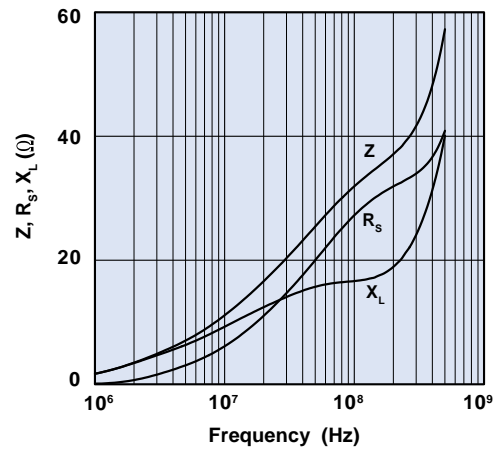


Figure 20 Impedance vs. Frequency for connector EMI suppression plate 2644373941.

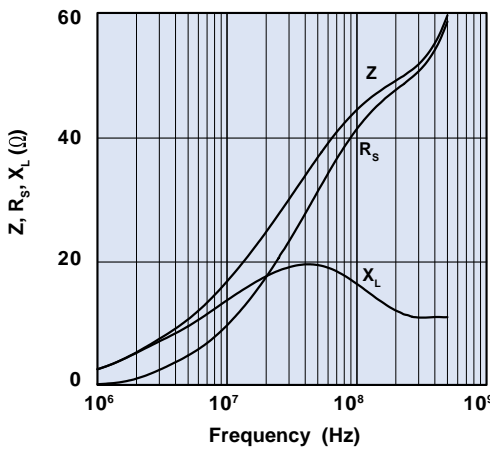
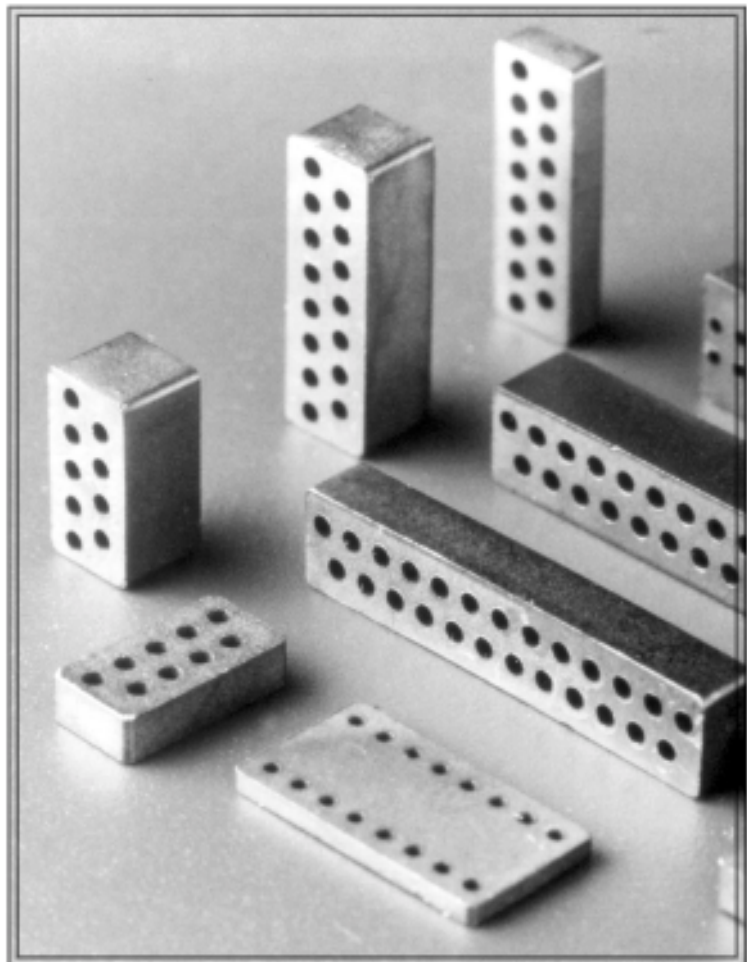


Figure 21 Impedance vs. Frequency for connector EMI suppression plate 2644373841.



# Tile Absorber

## Ferrite Tile Absorber

for EMC Test Chamber  
Applications from 30-1500 MHz



P.O. Box J, One Commercial Row, Wallkill, NY 12589-0288

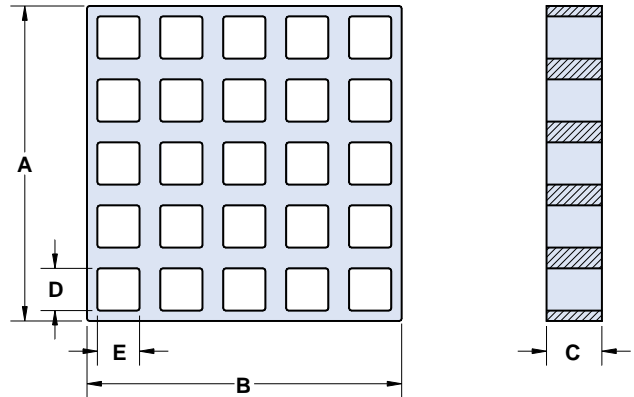
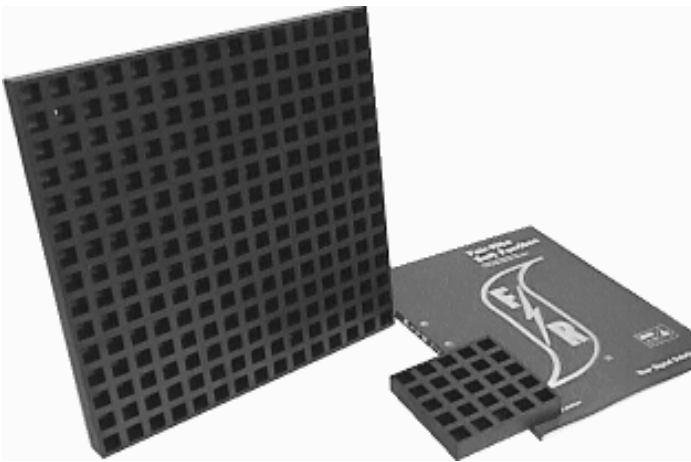
**Fair-Rite Products Corp.**

Phone: (888) FAIR RITE / (845) 895-2055 • FAX: (888) FERRITE / (845) 895-2629 • [www.fair-rite.com](http://www.fair-rite.com) • E-Mail: [ferrites@fair-rite.com](mailto:ferrites@fair-rite.com)  
(888) 324-7748 (888) 337-7483 **Note: (914) Area Code has changed to (845).**

# Tile Absorber

## NAMAS-1-U Grid Tile Absorber

This tile offers premium performance with wide-band absorption from 30-1500 MHz and exhibit improved low-frequency (up to -20 dB @ 30 MHz) performance with reduced gap loss effects compared to flat tiles. These tiles can be installed using single tiles or using 300 x300 mm panels for faster mounting. Panels are also available with perforated steel backing for coverage of chamber air vents, light openings or for chamber view ports. The naturally inert ferrite material is incombustible.



### Grid Tile

Dimensions (Bold numbers are in millimeters, light numbers are in inches.)

Part Number	A	B	C	D	E	Wt (g)
3642014000	<b>100±0.7</b> 3.937	<b>100±0.7</b> 3.937	<b>17.6±0.5</b> .693	<b>13.4</b> .527	<b>13.4</b> .527	500

### Panels

Dimensions (Bold numbers are in millimeters, light numbers are in inches.)

Part Number	A	B	C	Wt (kg)
3742014000	<b>300</b> 23.62	<b>300</b> 23.62	<b>18.8</b> .74	5.5

**Std Panel:** 9 Grid Tiles epoxy bonded to solid 1.2mm zinc coated steel with 5 pre-drilled mounting holes.

Part Number	A	B	C	Wt (kg)
3742014010	<b>300</b> 23.62	<b>300</b> 23.62	<b>18.8</b> .74	5.3

**Vent Panel:** 9 Grid Tiles epoxy bonded to perforated 1.2mm zinc coated steel with 5 pre-drilled mounting holes.

### 42 Material Properties

Specific Gravity	5.2
Young's Modulus	1.8 x 10 <sup>4</sup> kgf/mm <sup>2</sup>
Tensile Strength	4.9 kgf/mm <sup>2</sup>
Compressive Strength	42 kgf/mm <sup>2</sup>
Flexural Strength	6 kgf/mm <sup>2</sup>
Vickers Hardness	740
Coeff. of Thermal Expansion	9 x 10 <sup>-6</sup> /°C
Initial Permeability (relative)	2100 μ <sub>r</sub>
Relative Permittivity	14 ε <sub>r</sub>
Resistivity	5x10 <sup>6</sup> ohm-cm
Curie Temperature	95°C
Composition	Nickel-Zinc Ferrite

# Tile Absorber

## 100mm Tiles

This tile is the industry standard size and exhibits excellent overall performance vs. cost. These 100mm tiles can be installed individually using screws or adhesive and are optionally available in panel format. The 5.5mm thickness is ideally suited for compact pre-compliance emissions and IEC-61000-4-3 radiated immunity chambers, while the 6.3mm thickness is recommended for use in ANSI C63.4 compliant 3 meter chambers. Tiles are surface ground on all sides to precise mechanical tolerances, minimizing gaps between adjacent tiles to ensure maximum low-frequency performance.

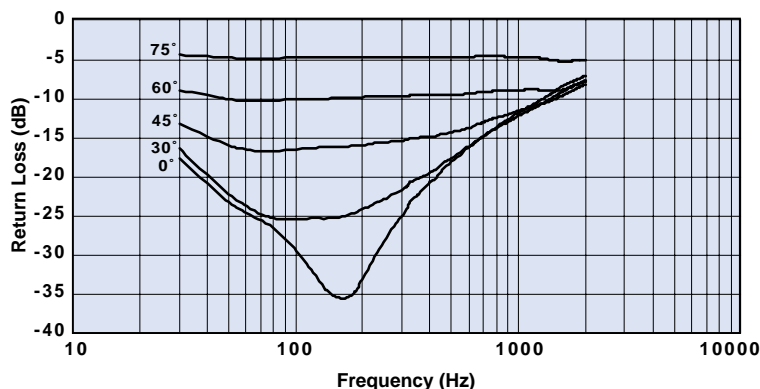
### 6.3mm Return Loss (dB)

Freq (MHz)						
30	100	200	400	600	1000	1500
-18	-25	-30	-25	-20	-12	-9

**Notes:**

- For more technical information on absorber tile applications, see "Ferrite Tile Absorbers for EMC Test Chamber Applications" on page 182.
- Return Loss values measured in 39mm coaxial airline, using HP 8753D Analyzer.

### Wide-Angle Return Loss - TM Polarization

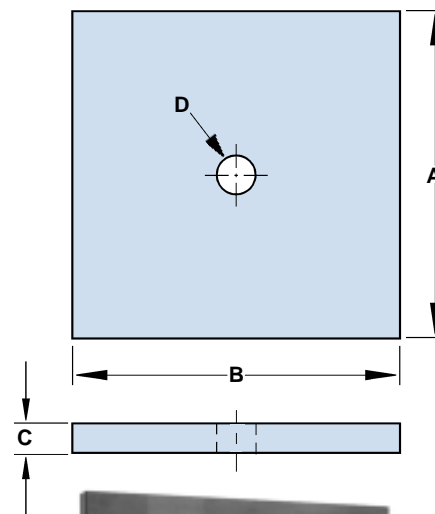


## 100mm Tiles

**Dimensions** (Bold numbers are in millimeters, light numbers are in inches.)

Part Number	A	B	C*	D	Wt (g)
3642011601	<b>100±0.13</b> 3.937	<b>100±0.13</b> 3.937	<b>6.3±0.13</b> .248	<b>10±0.3</b> .394	324
3642012401	<b>100±0.13</b> 3.937	<b>100±0.13</b> 3.937	<b>5.5±0.13</b> .217	<b>10±0.3</b> .394	290

\* This dimension may be modified. Thicknesses are available from 5.0 to 6.7mm



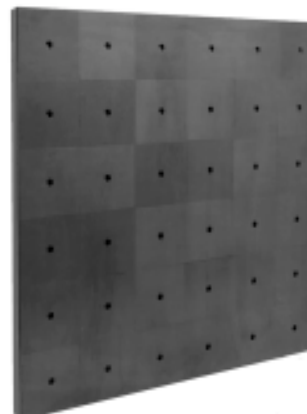
## Panels

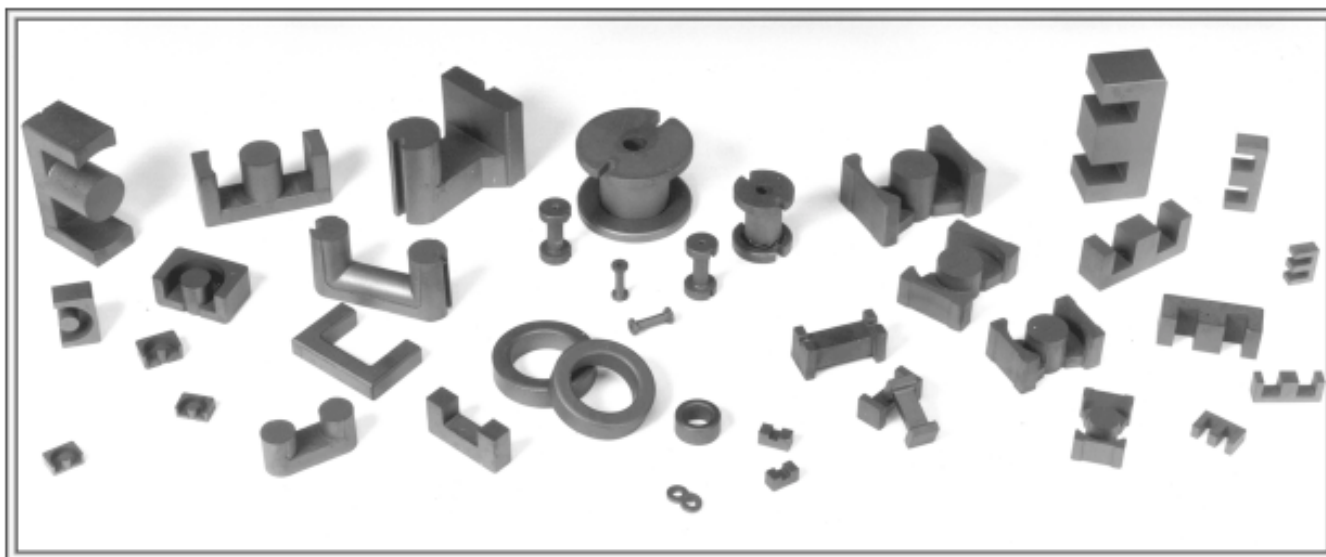
**Dimensions** (Bold numbers are in millimeters, light numbers are in inches.)

Part Number	A	B	C	Wt (kg)
3742011901	<b>600</b> 23.62	<b>600</b> 23.62	<b>16.8</b> .66	17.7

**Each panel consists of:**

36 Ferrite Tiles epoxy bonded to **9mm (.35")** particle board faced with 26 GA (**0.46mm**) zinc coated steel on two sides.





# Inductive Components



**Fair-Rite Products Corp.** P.O. Box J, One Commercial Row, Wallkill, NY 12589-0288

Phone: (888) FAIR RITE / (845) 895-2055 • FAX: (888) FERRITE / (845) 895-2629 • www.fair-rite.com • E-Mail: ferrites@fair-rite.com  
(888) 324-7748 Note: (914) Area Code has changed to (845).



# Rods

The simplest form of Fair-Rite pressed cores, used extensively for inductive devices when inductance tolerances of  $\pm 10\%$  are permissible.

Applications include coils for differential input filters, chokes for SCR and triac circuits, inductors in audio cross-over networks, ignition coils, and pulse transformers.

- The "A" dimension can be centerless ground to tighter tolerances.
- Rods 4277142009 through 4277453509 are used in the assembled bobbins, listed on page 134, Figure 5. These rods have a **0.6mm** (.025") max. chamfer on the outside corners.
- **33 material is not recommended for new designs.**
- For information on rod permeability vs. rod dimensions, see page 131.
- For parts specifically designed for RFID applications, please refer to our RFID Rods section found on page 132.
- For any rod requirement not listed in the catalog, please contact our customer service group for availability and pricing.

## Dimensions

(Bold numbers are in millimeters, light numbers are nominal in inches.)

Part Number**	Fig.	A	B	C*	Wt (g)
<b>4061032221</b>	1	<b>0.95±0.025</b> .037	—	<b>7.9±0.3</b> .312	.08
4033032221	1	<b>0.95±0.025</b> .037	—	<b>7.9±0.3</b> .312	.08
<b>4077032221</b>	1	<b>0.95±0.025</b> .037	—	<b>7.9±0.3</b> .312	.08
<b>4061129011</b>	1	<b>3.25 - 0.25</b> .125	—	<b>12.7±0.4</b> .500	.5
4033129021	1	<b>3.25 - 0.25</b> .125	—	<b>12.7±0.4</b> .500	.5
<b>4061128011</b>	1	<b>3.25 - 0.25</b> .125	—	<b>19.05±0.75</b> .750	.8
4033128021	1	<b>3.25 - 0.25</b> .125	—	<b>19.05±0.75</b> .750	.8
<b>4061122011</b>	1	<b>3.25 - 0.25</b> .125	—	<b>25.4±0.75</b> 1.000	1.1
4033122011	1	<b>3.25 - 0.25</b> .125	—	<b>25.4±0.75</b> 1.000	1.1
<b>4061172011</b>	1	<b>4.6 - 0.3</b> .175	—	<b>22.2±0.75</b> .875	1.9
<b>4077172011</b>	1	<b>4.6 - 0.3</b> .175	—	<b>22.2±0.75</b> .875	1.9
<b>4061272011</b>	1	<b>6.35±0.25</b> .250	—	<b>19.05±0.75</b> .750	2.7
<b>4077272011</b>	1	<b>6.35±0.25</b> .250	—	<b>19.05±0.75</b> .750	2.7
<b>4061287011</b>	1	<b>6.35±0.25</b> .250	—	<b>22.1±0.7</b> .870	3.5
4033287011	1	<b>6.35±0.25</b> .250	—	<b>22.1±0.7</b> .870	3.5
<b>4077287011</b>	1	<b>6.35±0.25</b> .250	—	<b>22.1±0.7</b> .870	3.5
<b>4061276011</b>	1	<b>6.35±0.25</b> .250	—	<b>25.4±0.7</b> 1.000	3.8

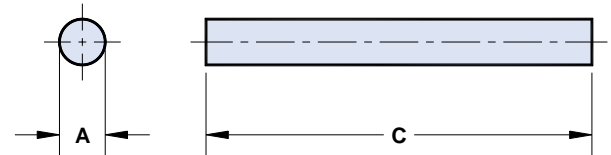


Figure 1

\* This dimension may be modified to suit specific applications.

\*\* Bold part numbers designate preferred parts.

# Rods

## Dimensions

(Bold numbers are in millimeters, light numbers are nominal in inches.)

Part Number**	Fig.	A	B	C*	Wt (g)
4033276011	1	<b>6.35±0.25</b> .250	—	<b>25.4±0.7</b> 1.000	3.8
<b>4077276011</b>	1	<b>6.35±0.25</b> .250	—	<b>25.4±0.7</b> 1.000	3.8
<b>4061292011</b>	1	<b>6.35±0.25</b> .250	—	<b>28.6±0.7</b> 1.125	4.4
4033292011	1	<b>6.35±0.25</b> .250	—	<b>28.6±0.7</b> 1.125	4.4
<b>4077292011</b>	1	<b>6.35±0.25</b> .250	—	<b>28.6±0.7</b> 1.125	4.4
<b>4061296011</b>	1	<b>6.35±0.25</b> .250	—	<b>31.75±0.75</b> 1.250	4.8
4033296011	1	<b>6.35±0.25</b> .250	—	<b>31.75±0.75</b> 1.250	4.8
<b>4077296011</b>	1	<b>6.35±0.25</b> .250	—	<b>31.75±0.75</b> 1.250	4.8
<b>4061266011</b>	1	<b>6.35±0.25</b> .250	—	<b>38.1±0.75</b> 1.500	5.9
4033266011	1	<b>6.35±0.25</b> .250	—	<b>38.1±0.75</b> 1.500	5.9
<b>4077266011</b>	1	<b>6.35±0.25</b> .250	—	<b>38.1±0.75</b> 1.500	5.9
<b>4077312911</b>	1	<b>8.0±0.35</b> .315	—	<b>38.1±0.75</b> 1.500	9.1
<b>4077374711</b>	1	<b>9.45±0.2</b> .372	—	<b>31.75±0.75</b> 1.250	11
<b>4077375411</b>	1	<b>9.45±0.2</b> .372	—	<b>41.3±0.8</b> 1.625	14
<b>4077375211</b>	1	<b>9.45±0.2</b> .372	—	<b>50.8±1.0</b> 2.000	18
<b>4077485111</b>	1	<b>12.3±0.4</b> .485	—	<b>31.75±0.75</b> 1.250	19
<b>4077484611</b>	1	<b>12.3±0.4</b> .485	—	<b>41.3±0.8</b> 1.625	24
<b>4277142009</b>	2	<b>9.0±0.3</b> .354	<b>3.2±0.1</b> .126	<b>13.5±0.3</b> .532	3.7
<b>4277182009</b>	2	<b>11.0±0.3</b> .433	<b>3.2±0.1</b> .126	<b>13.5±0.3</b> .532	5.7
<b>4277182209</b>	2	<b>11.0±0.3</b> .433	<b>3.2±0.1</b> .126	<b>15.5±0.35</b> .610	6.6
<b>4277242009</b>	2	<b>13.0±0.3</b> .512	<b>3.2±0.1</b> .126	<b>13.5±0.3</b> .532	8.3
<b>4277242409</b>	2	<b>13.0±0.3</b> .512	<b>3.2±0.1</b> .126	<b>17.5±0.4</b> .690	11
<b>4277282009</b>	2	<b>17.0±0.4</b> .670	<b>4.2±0.15</b> .165	<b>13.5±0.3</b> .532	14
<b>4277282509</b>	2	<b>17.0±0.4</b> .670	<b>4.2±0.15</b> .165	<b>18.95±0.45</b> .746	19
<b>4277352509</b>	2	<b>21.0±0.5</b> .825	<b>6.9±0.4</b> .272	<b>18.95±0.45</b> .746	28
<b>4277353509</b>	2	<b>21.0±0.5</b> .825	<b>6.9±0.4</b> .272	<b>29.0±0.6</b> 1.140	43
<b>4277453509</b>	2	<b>27.0±0.5</b> 1.063	<b>9.0±0.3</b> .354	<b>27.0±0.6</b> 1.064	66

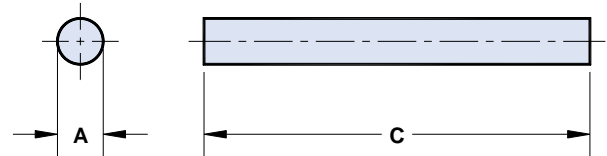


Figure 1

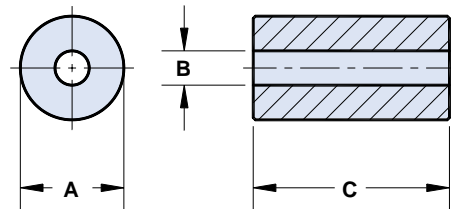


Figure 2

\* This dimension may be modified to suit specific applications.

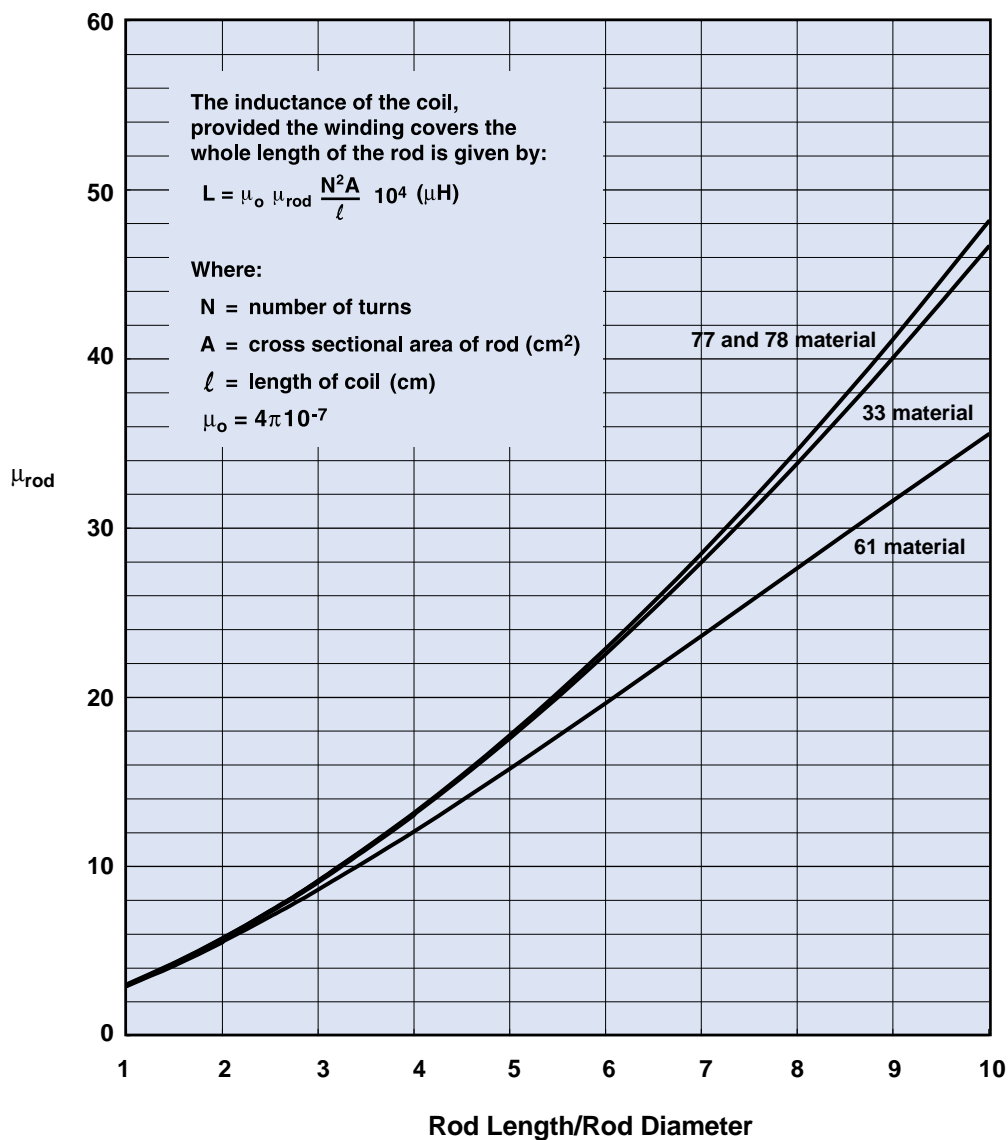
\*\* Bold part numbers designate preferred parts.

# Rods

This family of curves shows the value of the effective permeability of a ferrite rod as a function of its length to diameter ratio, as well as a function of the material permeability of the rod. It illustrates that generally, a great difference exists between the material permeability and the effective permeability of a rod. It also

illustrates how, in some instances, the effective permeability of a rod can be influenced by changing its mechanical dimensions more than by changing its material permeability, while in other cases, the reverse is true.

## Rod Permeability vs. Rod Length divided by Rod Diameter



# RFID Rods

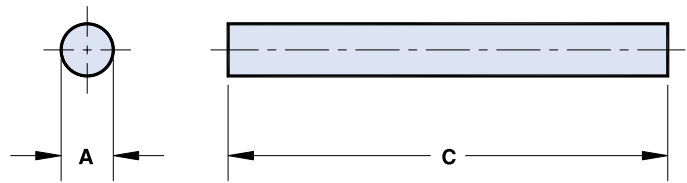
This new product is specifically designed for use in transponders in RFID applications. Fair-Rite offers two materials for the two operating frequency bands, centered around 125 kHz and 13.56 MHz, in an assortment of sizes.

- 78 material is recommended for 125 kHz applications and 61 material is recommended for 13.56 MHz applications.
- $\mu_{rod}$  is an empirical value derived from the graph on page 131 and is to be used for reference only.
- For any RFID rod requirement not listed in the catalog, please contact our customer service group for availability and pricing.
- The RFID Kit (part number 019900024) contains a selection of these RFID rods. See page 92.

## Dimensions

(Bold numbers are in millimeters, light numbers are nominal in inches.)

Part Number**	A	C*	$\mu_{ROD}$
3061990821	<b>0.75±0.025</b> .030	<b>7.5±0.15</b> .295	35
3078990821	<b>0.75±0.025</b> .030	<b>7.5±0.15</b> .295	48
3061990831	<b>1.0±0.025</b> .039	<b>10.0±0.20</b> .394	35
3078990831	<b>1.0±0.025</b> .039	<b>10.0±0.20</b> .394	48
3061990841	<b>1.5±0.025</b> .059	<b>15.0±0.30</b> .591	35
3078990841	<b>1.5±0.025</b> .059	<b>15.0±0.30</b> .591	48
3061990851	<b>2.0±0.025</b> .079	<b>15.0±0.30</b> .591	25
3078990851	<b>2.0±0.025</b> .079	<b>15.0±0.30</b> .591	31
3061990861	<b>2.5±0.025</b> .098	<b>20.0±0.40</b> .787	27
3078990861	<b>2.5±0.025</b> .098	<b>20.0±0.40</b> .787	34
3061990871	<b>3.0±0.04</b> .118	<b>25.0±0.50</b> .984	29
3078990871	<b>3.0±0.04</b> .118	<b>25.0±0.50</b> .984	36
3061990881	<b>4.0±0.04</b> .157	<b>30.0±0.60</b> 1.181	25
3078990881	<b>4.0±0.04</b> .157	<b>30.0±0.60</b> 1.181	31
3061990891	<b>5.0±0.04</b> .197	<b>35.0±0.70</b> 1.378	24
3078990891	<b>5.0±0.04</b> .197	<b>35.0±0.70</b> 1.378	29
3061990901	<b>6.0±0.05</b> .236	<b>40.0±0.80</b> 1.575	22
3078990901	<b>6.0±0.05</b> .236	<b>40.0±0.80</b> 1.575	26
3061990911	<b>8.0±0.05</b> .315	<b>45.0±0.90</b> 1.772	18
3078990911	<b>8.0±0.05</b> .315	<b>45.0±0.90</b> 1.772	20



\* This dimension may be modified to suit specific applications.

\*\* Bold part numbers designate preferred parts.

Fair-Rite Products Corp.

P.O. Box J, One Commercial Row, Wallkill, NY 12589-0288

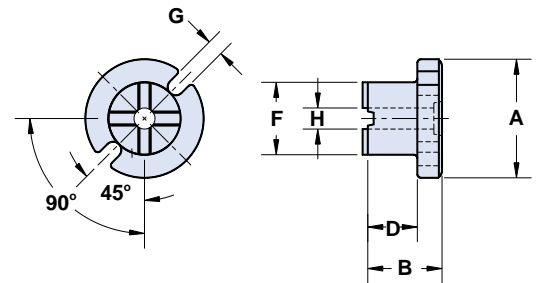
Phone: (888) FAIR RITE / (845) 895-2055 • FAX: (888) FERRITE / (845) 895-2629 • www.fair-rite.com • E-Mail: ferrites@fair-rite.com  
(888) 324-7748 Note: (914) Area Code has changed to (845).

# Tack Bobbin Cores

## Innovators Again - Patent Pending

Self-centering tack bobbin cores can be easily assembled into bobbin cores. This will accommodate heavy wire, pre-wound coils that might be difficult to wind directly on bobbins.

- Tack cores are tested for  $A_L$  value at 1kHz, < 10 gauss.
- Tack cores can also be purchased as assembled parts. (See page 134.)
- For any tack bobbin core requirement not listed in the catalog, please contact our customer service group for availability and pricing.



Dimensional letter designations have been changed from the 13th edition catalog and are now in accordance to the MMPA SFG-96.

Dimensions (Bold numbers are in millimeters, light numbers are nominal in inches.)

Part Number**	A	B*	D	F	G	H	Wt (g)
<b>7177141009</b>	<b>14.0±0.35</b> .551	<b>10.0±0.35</b> .394	<b>6.25±0.15</b> .247	<b>9.0±0.3</b> .354	<b>2.0±0.3</b> .079	<b>3.2±0.1</b> .126	4.2
<b>7177181009</b>	<b>18.0±0.45</b> .709	<b>10.0±0.35</b> .394	<b>6.25±0.15</b> .247	<b>11.0±0.3</b> .433	<b>2.5±0.3</b> .098	<b>3.2±0.1</b> .126	6.5
<b>7177181109</b>	<b>18.0±0.45</b> .709	<b>11.0±0.35</b> .433	<b>7.25±0.15</b> .285	<b>11.0±0.3</b> .433	<b>2.5±0.3</b> .098	<b>3.2±0.1</b> .126	7.0
<b>7177241009</b>	<b>24.0±0.6</b> .945	<b>10.0±0.35</b> .394	<b>6.25±0.15</b> .247	<b>13.0±0.3</b> .512	<b>3.0±0.3</b> .118	<b>3.2±0.1</b> .126	11
<b>7177241209</b>	<b>24.0±0.6</b> .945	<b>12.0±0.35</b> .472	<b>8.25±0.20</b> .325	<b>13.0±0.3</b> .512	<b>3.0±0.3</b> .118	<b>3.2±0.1</b> .126	12

\*\*Bold part numbers designate preferred parts.

\*These dimensions may be modified to suit specific applications.

## Magnetic Parameters (For assembly of two tack bobbin cores.)

Part Number	$A_L$ (nH)±10%	$A_L$ min. @ NI (At)	N/AWG	$A_w$ (cm <sup>2</sup> )
<b>7177141009</b>	52	44 325	81/28	.31
<b>7177181009</b>	66	56 400	50/20	.44
<b>7177181109</b>	65	55 410	95/22	.51
<b>7177241009</b>	88	75 430	50/18	.69
<b>7177241209</b>	84	72 450	67/18	.91

Symbols	Definitions
$A_L$	Inductance factor ( $\frac{L}{N^2}$ )
NI	Value of dc ampere-turns
$A_w$	Winding Area
N/AWG	Number of Turns/ wire size for test coil

# Bobbins

Bobbins are an economical and well-proven core design for many applications where relatively low but stable inductance values are required.

- For higher frequency designs, use a small bobbin (Figure 1) in 43 material.
- For power applications, bobbins in 77 material are specified for  $A_L$  and dc bias limits.
- Bobbins in Figures 2-5 can be supplied with a uniform coating of white thermo-set plastic coating which can withstand a minimum breakdown of 500Vrms. This coating will change the dimensions a maximum of **0.25mm (.010")**. The last digit of the thermo-set plastic coated part is an "8". Bobbins in Figure 5 can be supplied with notches at one end only. This changes the last digit of the part number to a "7". Bobbins of this type can also be provided with a thermo-set plastic coating. The last digit then becomes a "6".
- The listed dimensions are for assembled bobbins without thermo-set plastic coating.
- Bobbins are tested for  $A_L$  value at 1kHz, < 10 gauss.
- Bobbins 9677142089 through 9677242489 can also be purchased as tack bobbin cores. (See page 133.)
- For any bobbin requirement not listed in the catalog, please contact our customer service group for availability and pricing.

**Dimensions** (Bold numbers are in millimeters, light numbers are nominal in inches.)

Part Number*	Fig.	A	B	D	F	G	H	Wt (g)
<b>9643001165</b>	1	<b>5.05 - 0.15</b> .196	<b>12.7±0.25</b> .500	<b>10.0+0.3</b> .400	<b>2.65+0.1</b> .107	<b>0.5±0.1</b> .020	<b>1.0+0.1</b> .042	1.3
<b>9677001165</b>	1	<b>5.05 - 0.15</b> .196	<b>12.7±0.25</b> .500	<b>10.0+0.3</b> .400	<b>2.65+0.1</b> .107	<b>0.5±0.1</b> .020	<b>1.0+0.1</b> .042	1.3
<b>9643001015</b>	1	<b>9.55 - 0.15</b> .373	<b>19.0±0.7</b> .750	<b>12.7±0.15</b> .500	<b>4.65+0.2</b> .187	<b>1.0+0.25</b> .045	<b>1.0+0.1</b> .042	6.7
<b>9677001015</b>	1	<b>9.55 - 0.15</b> .373	<b>19.0±0.7</b> .750	<b>12.7±0.15</b> .500	<b>4.65+0.2</b> .187	<b>1.0+0.25</b> .045	<b>1.0+0.1</b> .042	6.7
<b>9843000104</b>	2	<b>8.05±0.2</b> .317	<b>19.0±0.4</b> .750	<b>12.7±0.25</b> .500	<b>5.55+0.25</b> .225	<b>2.7+0.25</b> .111	<b>8.05±0.2</b> .317	3.0
<b>9877000104</b>	2	<b>8.05±0.2</b> .317	<b>19.0±0.4</b> .750	<b>12.7±0.25</b> .500	<b>5.55+0.25</b> .225	<b>2.7+0.25</b> .111	<b>8.05±0.2</b> .317	3.0
<b>9877000204</b>	3	<b>11.3±0.25</b> .445	<b>24.4±0.5</b> .960	<b>17.8+0.9</b> .718	<b>7.5±0.25</b> .295	<b>7.25±0.25</b> .285	<b>11.2±0.4</b> .440	8.4
<b>9677142089</b>	4	<b>14.0±0.35</b> .551	<b>20.0±0.7</b> .788	<b>12.5±0.3</b> .492	<b>9.0±0.3</b> .354	<b>2.0±0.3</b> .079	<b>3.2±0.1</b> .126	8.5
<b>9677182089</b>	4	<b>18.0±0.45</b> .709	<b>20.0±0.7</b> .788	<b>12.5±0.3</b> .492	<b>11.0±0.3</b> .433	<b>2.5±0.3</b> .098	<b>3.2±0.1</b> .126	13
<b>9677182289</b>	4	<b>18.0±0.45</b> .709	<b>22.0±0.7</b> .866	<b>14.5±0.35</b> .570	<b>11.0±0.3</b> .433	<b>2.5±0.3</b> .098	<b>3.2±0.1</b> .126	14
<b>9677242089</b>	4	<b>24.0±0.6</b> .945	<b>20.0±0.7</b> .788	<b>12.5±0.3</b> .492	<b>13.0±0.3</b> .512	<b>3.0±0.3</b> .118	<b>3.2±0.1</b> .126	22
<b>9677242489</b>	4	<b>24.0±0.6</b> .945	<b>24.0±0.7</b> .946	<b>16.5±0.4</b> .650	<b>13.0±0.3</b> .512	<b>3.0±0.3</b> .118	<b>3.2±0.1</b> .126	24
<b>9677282009</b>	5	<b>28.0±0.7</b> 1.102	<b>20.0±0.7</b> .788	<b>12.5±0.3</b> .492	<b>17.0±0.4</b> .670	<b>3.0±0.3</b> .118	<b>4.2±0.15</b> .165	33
<b>9677282509</b>	5	<b>28.0±0.7</b> 1.102	<b>25.0±0.7</b> .985	<b>18.0±0.45</b> .708	<b>17.0±0.4</b> .670	<b>3.0±0.3</b> .118	<b>4.2±0.15</b> .165	38
<b>9677352509</b>	5	<b>35.0±0.9</b> 1.381	<b>25.0±0.7</b> .985	<b>18.0±0.45</b> .708	<b>21.0±0.5</b> .825	<b>3.0±0.3</b> .118	<b>6.9±0.4</b> .272	56
<b>9677353509</b>	5	<b>35.0±0.9</b> 1.381	<b>35.0±0.75</b> 1.380	<b>28.0±0.6</b> 1.100	<b>21.0±0.5</b> .825	<b>3.0±0.3</b> .118	<b>6.9±0.4</b> .272	71
<b>9677453509</b>	5	<b>45.0±1.0</b> 1.771	<b>35.0±0.75</b> 1.380	<b>26.0±0.6</b> 1.024	<b>27.0±0.5</b> 1.063	<b>3.6±0.3</b> .142	<b>9.0±0.3</b> .354	127

Innovators  
Again  
Patent  
Pending

\* Bold part numbers designate preferred parts.

**Fair-Rite Products Corp.** P.O. Box J, One Commercial Row, Wallkill, NY 12589-0288

Phone: (888) FAIR RITE / (845) 895-2055 • FAX: (888) FERRITE / (845) 895-2629 • www.fair-rite.com • E-Mail: ferrites@fair-rite.com  
(888) 324-7748 (888) 337-7483 Note: (914) Area Code has changed to (845).

# Bobbins

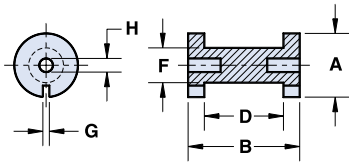


Figure 1

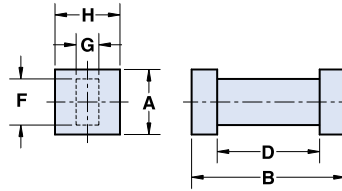


Figure 2

Dimensional letter designations have been changed from the 13th edition catalog and are now in accordance to the MMPA SFG-96.

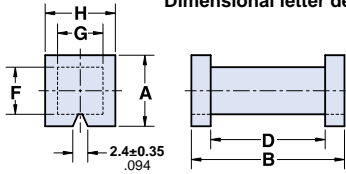


Figure 3

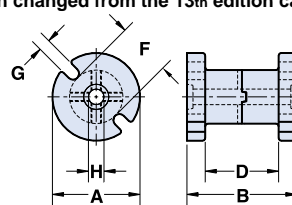


Figure 4

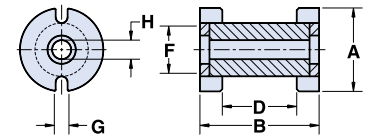


Figure 5

## Magnetic Parameters

Part Number*	$A_L$ (nH) ±10%	$A_L$ min. @ NI (At)		N/AWG	$A_w$ (cm <sup>2</sup> )
<b>9643001165</b>	17.5	-		30/24	.12
<b>9677001165</b>	18	15	90	30/24	.12
<b>9643001015</b>	38	-		75/24	.30
<b>9677001015</b>	39	33	125	75/24	.30
<b>9843000104</b>	38	-		50/28	.33
<b>9877000104</b>	39	33	125	36/24	.33
<b>9877000204</b>	49	42	360	45/24	.37
<b>9677142089</b>	52	44	325	81/28	.31
<b>9677182089</b>	66	56	400	50/20	.44
<b>9677182289</b>	65	55	410	95/22	.51
<b>9677242089</b>	88	75	430	50/18	.69
<b>9677242489</b>	84	72	450	67/18	.91
<b>9677282009</b>	100	86	470	40/18	.69
<b>9677282509</b>	95	81	520	55/18	.99
<b>9677352509</b>	124	106	580	55/16	1.27
<b>9677353509</b>	110	94	700	70/16	1.97
<b>9677453509</b>	142	121	750	100/16	2.34

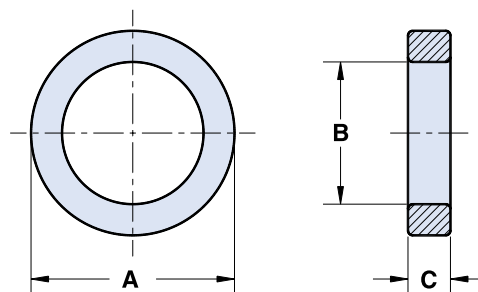
- Symbols**      **Definitions**
- $A_L$               Inductance factor ( $\frac{L}{N^2}$ )
  - NI**                Value of dc ampere-turns
  - $A_w$               Winding area
  - N/AWG**        Number of Turns/  
wire size for test coil

\* Bold part numbers designate preferred parts.

# Toroids

The ring configuration provides the ultimate in the utilization of the ferrite material properties. Power input filters, ground-fault interrupters, common mode filters, and a variety of pulse and matching transformers are only a few of the applications for this core type.

- All toroidal cores are supplied burnished to break the sharp edges.
- Toroidal cores in 43 material are only recommended for common-mode inductor applications.
- Toroids are tested for  $A_L$  values at 10 kHz and <10 gauss.
- Toroids with an outside diameter of **9.5mm (.375")** or larger can be supplied with a uniform coating of a white thermo-set plastic coating. This coating will increase the "A" and "C" dimensions and decrease the "B" dimension a maximum of **.25mm (.010")**. The 9<sup>th</sup> digit of the thermo-set plastic coated toroid part number is a "2".
- Thermo-set plastic coated parts can withstand a minimum breakdown voltage of 1000Vrms, uniformly applied across the "C" dimension of the core.
- Toroids with a diameter of **9.5mm (.375")** or smaller can be supplied Parylene C coated. This coating will increase the "A" and "C" dimensions and decrease the "B" dimension a maximum of **.038mm (.0015")**. The 9<sup>th</sup> digit of the Parylene coated toroid part number is a "1". See page 159 for material characteristics of Parylene C.
- For any toroid requirement not listed in the catalog, please contact our customer service group for availability and pricing.



**Dimensions** (Bold numbers are in millimeters, light numbers are nominal in inches.)

Part Number**	A	B	C*	Wt (g)	$\Sigma l/A(\text{cm}^{-1})$	$\ell_e(\text{cm})$	$A_e(\text{cm}^2)$	$V_e(\text{cm}^3)$	$A_L(\text{nH})$ $\pm 20\%$
<b>5943000801</b>	<b>3.95±0.15</b> .155	<b>2.15+0.15</b> .088	<b>1.35 - 0.15</b> .050	.05	87.6	0.92	0.011	0.0097	96 Min.
5977000801	<b>3.95±0.15</b> .155	<b>2.15+0.15</b> .088	<b>1.35 - 0.15</b> .050	.05	87.6	0.92	0.011	0.0097	285
<b>5978000801</b>	<b>3.95±0.15</b> .155	<b>2.15+0.15</b> .088	<b>1.35 - 0.15</b> .050	.05	87.6	0.92	0.011	0.0097	335
<b>5975000801</b>	<b>3.95±0.15</b> .155	<b>2.15+0.15</b> .088	<b>1.35 - 0.15</b> .050	.05	87.6	0.92	0.011	0.0097	715
<b>5976000801</b>	<b>3.95±0.15</b> .155	<b>2.15+0.15</b> .088	<b>1.35 - 0.15</b> .050	.05	87.6	0.92	0.011	0.0097	1430±30%
<b>5943002101</b>	<b>4.95 - 0.25</b> .190	<b>2.2+0.15</b> .090	<b>1.35 - 0.15</b> .050	.09	69.2	1.04	0.015	0.0157	128 Min.
5977002101	<b>4.95 - 0.25</b> .190	<b>2.2+0.15</b> .090	<b>1.35 - 0.15</b> .050	.09	69.2	1.04	0.015	0.0157	360
<b>5978002101</b>	<b>4.95 - 0.25</b> .190	<b>2.2+0.15</b> .090	<b>1.35 - 0.15</b> .050	.09	69.2	1.04	0.015	0.0157	440
<b>5975002101</b>	<b>4.95 - 0.25</b> .190	<b>2.2+0.15</b> .090	<b>1.35 - 0.15</b> .050	.09	69.2	1.04	0.015	0.0157	900
<b>5976002101</b>	<b>4.95 - 0.25</b> .190	<b>2.2+0.15</b> .090	<b>1.35 - 0.15</b> .050	.09	69.2	1.04	0.015	0.0157	1800±30%

\* This dimension may be modified to suit specific applications.

\*\* Bold part numbers designate preferred parts.

**Fair-Rite Products Corp.** P.O. Box J, One Commercial Row, Wallkill, NY 12589-0288

Phone: (888) FAIR RITE / (845) 895-2055 • FAX: (888) FERRITE / (845) 895-2629 • www.fair-rite.com • E-Mail: ferrites@fair-rite.com  
(888) 324-7748 Note: (914) Area Code has changed to (845).



# Toroids

Symbols	Definitions
$\Sigma l/A$	Core constant
$l_e$	Effective path length
$A_e$	Effective cross-sectional area
$V_e$	Effective core volume
$A_L$	Inductance factor ( $\frac{l_e}{N^2}$ )

**Dimensions** (Bold numbers are in millimeters, light numbers are nominal in inches.)

Part Number**	A	B	C*	Wt (g)	$\Sigma l/A(\text{cm}^{-1})$	$l_e$ (cm)	$A_e(\text{cm}^2)$	$V_e(\text{cm}^3)$	$A_L(\text{nH})$ $\pm 20\%$
<b>5961000101</b>	<b>5.95 - 0.25</b> .230	<b>3.05±0.1</b> .120	<b>1.65 - 0.25</b> .060	.14	63.8	1.30	0.020	0.027	25
<b>5943000101</b>	<b>5.95 - 0.25</b> .230	<b>3.05±0.1</b> .120	<b>1.65 - 0.25</b> .060	.14	63.8	1.30	0.020	0.027	132 Min.
5977000101	<b>5.95 - 0.25</b> .230	<b>3.05±0.1</b> .120	<b>1.65 - 0.25</b> .060	.14	63.8	1.30	0.020	0.027	390
<b>5978000101</b>	<b>5.95 - 0.25</b> .230	<b>3.05±0.1</b> .120	<b>1.65 - 0.25</b> .060	.14	63.8	1.30	0.020	0.027	455
<b>5975000101</b>	<b>5.95 - 0.25</b> .230	<b>3.05±0.1</b> .120	<b>1.65 - 0.25</b> .060	.14	63.8	1.30	0.020	0.027	975
<b>5976000101</b>	<b>5.95 - 0.25</b> .230	<b>3.05±0.1</b> .120	<b>1.65 - 0.25</b> .060	.14	63.8	1.30	0.020	0.027	1950±30%
<b>5961000201</b>	<b>9.5±0.2</b> .375	<b>4.75±0.15</b> .187	<b>3.3 - 0.25</b> .125	.83	28.6	2.07	0.072	0.15	55
<b>5943000201</b>	<b>9.5±0.2</b> .375	<b>4.75±0.15</b> .187	<b>3.3 - 0.25</b> .125	.83	28.6	2.07	0.072	0.15	300 Min.
5977000201	<b>9.5±0.2</b> .375	<b>4.75±0.15</b> .187	<b>3.3 - 0.25</b> .125	.83	28.6	2.07	0.072	0.15	880
<b>5978000201</b>	<b>9.5±0.2</b> .375	<b>4.75±0.15</b> .187	<b>3.3 - 0.25</b> .125	.83	28.6	2.07	0.072	0.15	1010
<b>5975000201</b>	<b>9.5±0.2</b> .375	<b>4.75±0.15</b> .187	<b>3.3 - 0.25</b> .125	.83	28.6	2.07	0.072	0.15	2200
<b>5976000201</b>	<b>9.5±0.2</b> .375	<b>4.75±0.15</b> .187	<b>3.3 - 0.25</b> .125	.83	28.6	2.07	0.072	0.15	4400±30%
<b>5961000301</b>	<b>12.7±0.25</b> .500	<b>7.15±0.2</b> .281	<b>4.9 - 0.25</b> .188	2.0	22.9	2.95	0.129	0.38	69
<b>5943000301</b>	<b>12.7±0.25</b> .500	<b>7.15±0.2</b> .281	<b>4.9 - 0.25</b> .188	2.0	22.9	2.95	0.129	0.38	375 Min.
5977000301	<b>12.7±0.25</b> .500	<b>7.15±0.2</b> .281	<b>4.9 - 0.25</b> .188	2.0	22.9	2.95	0.129	0.38	1100
<b>5978000301</b>	<b>12.7±0.25</b> .500	<b>7.15±0.2</b> .281	<b>4.9 - 0.25</b> .188	2.0	22.9	2.95	0.129	0.38	1260
<b>5975000301</b>	<b>12.7±0.25</b> .500	<b>7.15±0.2</b> .281	<b>4.9 - 0.25</b> .188	2.0	22.9	2.95	0.129	0.38	2725
<b>5961001101</b>	<b>12.7±0.25</b> .500	<b>7.9±0.2</b> .312	<b>6.35±0.25</b> .250	2.4	20.8	3.12	0.150	0.47	75
<b>5943001101</b>	<b>12.7±0.25</b> .500	<b>7.9±0.2</b> .312	<b>6.35±0.25</b> .250	2.4	20.8	3.12	0.150	0.47	410 Min.
5977001101	<b>12.7±0.25</b> .500	<b>7.9±0.2</b> .312	<b>6.35±0.25</b> .250	2.4	20.8	3.12	0.150	0.47	1200

\* This dimension may be modified to suit specific applications.

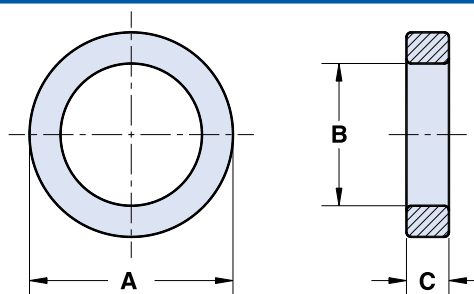
\*\* Bold part numbers designate preferred parts.

P.O. Box J, One Commercial Row, Wallkill, NY 12589-0288

Fair-Rite Products Corp.

Phone: (888) FAIR RITE / (845) 895-2055 • FAX: (888) FERRITE / (845) 895-2629 • www.fair-rite.com • E-Mail: ferrites@fair-rite.com  
(888) 324-7748 (888) 337-7483 Note: (914) Area Code has changed to (845).

# Toroids



Dimensions (Bold numbers are in millimeters, light numbers are nominal in inches.)

Part Number**	A	B	C*	Wt (g)	$\Sigma l/A(\text{cm}^{-1})$	$l_e(\text{cm})$	$A_e(\text{cm}^2)$	$V_e(\text{cm}^3)$	$A_L(\text{nH}) \pm 20\%$
<b>5978001101</b>	<b>12.7±0.25</b> .500	<b>7.9±0.2</b> .312	<b>6.35±0.25</b> .250	2.4	20.8	3.12	0.150	0.47	1390
<b>5975001101</b>	<b>12.7±0.25</b> .500	<b>7.9±0.2</b> .312	<b>6.35±0.25</b> .250	2.4	20.8	3.12	0.150	0.47	3000
<b>5961001901</b>	<b>12.7±0.25</b> .500	<b>7.9±0.2</b> .312	<b>12.7±0.35</b> .500	4.7	10.4	3.12	0.299	0.93	150
<b>5943001901</b>	<b>12.7±0.25</b> .500	<b>7.9±0.2</b> .312	<b>12.7±0.35</b> .500	4.7	10.4	3.12	0.299	0.93	820 Min.
5977001901	<b>12.7±0.25</b> .500	<b>7.9±0.2</b> .312	<b>12.7±0.35</b> .500	4.7	10.4	3.12	0.299	0.93	2400
<b>5978001901</b>	<b>12.7±0.25</b> .500	<b>7.9±0.2</b> .312	<b>12.7±0.35</b> .500	4.7	10.4	3.12	0.299	0.93	2775
<b>5975001901</b>	<b>12.7±0.25</b> .500	<b>7.9±0.2</b> .312	<b>12.7±0.35</b> .500	4.7	10.4	3.12	0.299	0.93	6000
<b>5943005101</b>	<b>16.0±0.4</b> .630	<b>9.6±0.3</b> .378	<b>4.75 - 0.25</b> .182	2.8	26.6	3.85	0.145	0.56	320 Min.
5977005101	<b>16.0±0.4</b> .630	<b>9.6±0.3</b> .378	<b>4.75 - 0.25</b> .182	2.8	26.6	3.85	0.145	0.56	940
<b>5978005101</b>	<b>16.0±0.4</b> .630	<b>9.6±0.3</b> .378	<b>4.75 - 0.25</b> .182	2.8	26.6	3.85	0.145	0.56	1090
<b>5975005101</b>	<b>16.0±0.4</b> .630	<b>9.6±0.3</b> .378	<b>4.75 - 0.25</b> .182	2.8	26.6	3.85	0.145	0.56	2350
<b>5961004901</b>	<b>16.0±0.4</b> .630	<b>9.6±0.3</b> .378	<b>6.35±0.25</b> .250	4.0	19.4	3.85	0.199	0.77	80
<b>5943004901</b>	<b>16.0±0.4</b> .630	<b>9.6±0.3</b> .378	<b>6.35±0.25</b> .250	4.0	19.4	3.85	0.199	0.77	440 Min.
5977004901	<b>16.0±0.4</b> .630	<b>9.6±0.3</b> .378	<b>6.35±0.25</b> .250	4.0	19.4	3.85	0.199	0.77	1300
<b>5978004901</b>	<b>16.0±0.4</b> .630	<b>9.6±0.3</b> .378	<b>6.35±0.25</b> .250	4.0	19.4	3.85	0.199	0.77	1490
<b>5975004901</b>	<b>16.0±0.4</b> .630	<b>9.6±0.3</b> .378	<b>6.35±0.25</b> .250	4.0	19.4	3.85	0.199	0.77	3225
<b>5961000601</b>	<b>21.0±0.35</b> .825	<b>13.2±0.3</b> .520	<b>6.35±0.25</b> .250	6.4	21.3	5.2	0.243	1.26	75
<b>5943000601</b>	<b>21.0±0.35</b> .825	<b>13.2±0.3</b> .520	<b>6.35±0.25</b> .250	6.4	21.3	5.2	0.243	1.26	400 Min.
5977000601	<b>21.0±0.35</b> .825	<b>13.2±0.3</b> .520	<b>6.35±0.25</b> .250	6.4	21.3	5.2	0.243	1.26	1175
<b>5978000601</b>	<b>21.0±0.35</b> .825	<b>13.2±0.3</b> .520	<b>6.35±0.25</b> .250	6.4	21.3	5.2	0.243	1.26	1355

\* This dimension may be modified to suit specific applications.

\*\* Bold part numbers designate preferred parts.

**Fair-Rite Products Corp.** P.O. Box J, One Commercial Row, Wallkill, NY 12589-0288

Phone: (888) FAIR RITE / (845) 895-2055 • FAX: (888) FERRITE / (845) 895-2629 • www.fair-rite.com • E-Mail: ferrites@fair-rite.com  
(888) 324-7748 (888) 337-7483 Note: (914) Area Code has changed to (845).

# Toroids

Symbols	Definitions
$\Sigma l/A$	Core constant
$l_e$	Effective path length
$A_e$	Effective cross-sectional area
$V_e$	Effective core volume
$A_L$	Inductance factor ( $\frac{L}{N^2}$ )

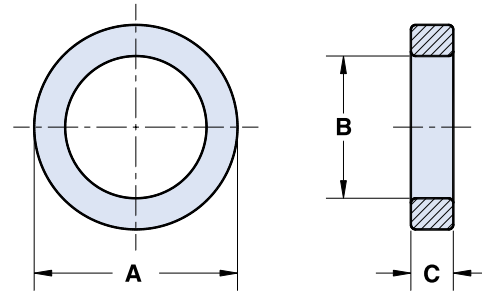
**Dimensions** (Bold numbers are in millimeters, light numbers are nominal in inches.)

Part Number**	A	B	C*	Wt (g)	$\Sigma l/A(\text{cm}^{-1})$	$l_e$ (cm)	$A_e(\text{cm}^2)$	$V_e(\text{cm}^3)$	$A_L(\text{nH})$ $\pm 20\%$
<b>5975000601</b>	<b>21.0±0.35</b> .825	<b>13.2±0.3</b> .520	<b>6.35±0.25</b> .250	6.4	21.3	5.2	0.243	1.26	2950
<b>5961000501</b>	<b>21.0±0.35</b> .825	<b>13.2±0.3</b> .520	<b>11.9±0.4</b> .468	12	11.4	5.2	0.46	2.36	135
<b>5943000501</b>	<b>21.0±0.35</b> .825	<b>13.2±0.3</b> .520	<b>11.9±0.4</b> .468	12	11.4	5.2	0.46	2.36	750 Min.
5977000501	<b>21.0±0.35</b> .825	<b>13.2±0.3</b> .520	<b>11.9±0.4</b> .468	12	11.4	5.2	0.46	2.36	2200
<b>5978000501</b>	<b>21.0±0.35</b> .825	<b>13.2±0.3</b> .520	<b>11.9±0.4</b> .468	12	11.4	5.2	0.46	2.36	2540
<b>5975000501</b>	<b>21.0±0.35</b> .825	<b>13.2±0.3</b> .520	<b>11.9±0.4</b> .468	12	11.4	5.2	0.46	2.36	5500
<b>5961001801</b>	<b>22.1±0.4</b> .870	<b>13.7±0.3</b> .540	<b>6.35±0.25</b> .250	7.2	20.7	5.4	0.262	1.42	75
<b>5943001801</b>	<b>22.1±0.4</b> .870	<b>13.7±0.3</b> .540	<b>6.35±0.25</b> .250	7.2	20.7	5.4	0.262	1.42	410 Min.
5977001801	<b>22.1±0.4</b> .870	<b>13.7±0.3</b> .540	<b>6.35±0.25</b> .250	7.2	20.7	5.4	0.262	1.42	1200
<b>5978001801</b>	<b>22.1±0.4</b> .870	<b>13.7±0.3</b> .540	<b>6.35±0.25</b> .250	7.2	20.7	5.4	0.262	1.42	1400
<b>5975001801</b>	<b>22.1±0.4</b> .870	<b>13.7±0.3</b> .540	<b>6.35±0.25</b> .250	7.2	20.7	5.4	0.262	1.42	3025
<b>5943007601</b>	<b>22.1±0.4</b> .870	<b>13.7±0.3</b> .540	<b>12.7±0.45</b> .500	15	10.3	5.4	0.52	2.83	820 Min.
5977007601	<b>22.1±0.4</b> .870	<b>13.7±0.3</b> .540	<b>12.7±0.45</b> .500	15	10.3	5.4	0.52	2.83	2425
<b>5978007601</b>	<b>22.1±0.4</b> .870	<b>13.7±0.3</b> .540	<b>12.7±0.45</b> .500	15	10.3	5.4	0.52	2.83	2795
<b>5975007601</b>	<b>22.1±0.4</b> .870	<b>13.7±0.3</b> .540	<b>12.7±0.45</b> .500	15	10.3	5.4	0.52	2.83	6100
<b>5943001301</b>	<b>25.4±0.6</b> 1.000	<b>15.5±0.5</b> .610	<b>6.35±0.25</b> .250	9.6	20.0	6.2	0.308	1.90	425 Min.
5977001301	<b>25.4±0.6</b> 1.000	<b>15.5±0.5</b> .610	<b>6.35±0.25</b> .250	9.6	20.0	6.2	0.308	1.90	1250
<b>5978001301</b>	<b>25.4±0.6</b> 1.000	<b>15.5±0.5</b> .610	<b>6.35±0.25</b> .250	9.6	20.0	6.2	0.308	1.90	1445
<b>5943001401</b>	<b>25.4±0.6</b> 1.000	<b>15.5±0.5</b> .610	<b>8.15±0.3</b> .320	12	15.1	6.2	0.41	2.52	560 Min.
5977001401	<b>25.4±0.6</b> 1.000	<b>15.5±0.5</b> .610	<b>8.15±0.3</b> .320	12	15.1	6.2	0.41	2.52	1600

\* This dimension may be modified to suit specific applications.

\*\* Bold part numbers designate preferred parts.

# Toroids



Dimensions (Bold numbers are in millimeters, light numbers are nominal in inches.)

Part Number**	A	B	C*	Wt (g)	$\Sigma l/A(\text{cm}^{-1})$	$\ell_e(\text{cm})$	$A_e(\text{cm}^2)$	$V_e(\text{cm}^3)$	$A_L(\text{nH})$ $\pm 20\%$
<b>5978001401</b>	<b>25.4±0.6</b> 1.000	<b>15.5±0.5</b> .610	<b>8.15±0.3</b> .320	12	15.1	6.2	0.41	2.52	1850
<b>5943006401</b>	<b>25.4±0.6</b> 1.000	<b>15.5±0.5</b> .610	<b>12.7±0.5</b> .500	19	10.0	6.2	0.62	3.80	850 Min.
5977006401	<b>25.4±0.6</b> 1.000	<b>15.5±0.5</b> .610	<b>12.7±0.5</b> .500	19	10.0	6.2	0.62	3.80	2500
<b>5978006401</b>	<b>25.4±0.6</b> 1.000	<b>15.5±0.5</b> .610	<b>12.7±0.5</b> .500	19	10.0	6.2	0.62	3.80	2885
<b>5961001001</b>	<b>29.0±0.65</b> 1.142	<b>19.0±0.5</b> .748	<b>7.5±0.25</b> .295	13	19.8	7.3	0.37	2.70	80
<b>5943001001</b>	<b>29.0±0.65</b> 1.142	<b>19.0±0.5</b> .748	<b>7.5±0.25</b> .295	13	19.8	7.3	0.37	2.70	430 Min.
5977001001	<b>29.0±0.65</b> 1.142	<b>19.0±0.5</b> .748	<b>7.5±0.25</b> .295	13	19.8	7.3	0.37	2.70	1275
<b>5978001001</b>	<b>29.0±0.65</b> 1.142	<b>19.0±0.5</b> .748	<b>7.5±0.25</b> .295	13	19.8	7.3	0.37	2.70	1460
<b>5961001201</b>	<b>29.0±0.65</b> 1.142	<b>19.0±0.5</b> .748	<b>13.85±0.3</b> .545	26	10.7	7.3	0.68	5.0	145
<b>5943001201</b>	<b>29.0±0.65</b> 1.142	<b>19.0±0.5</b> .748	<b>13.85±0.3</b> .545	26	10.7	7.3	0.68	5.0	800 Min.
5977001201	<b>29.0±0.65</b> 1.142	<b>19.0±0.5</b> .748	<b>13.85±0.3</b> .545	26	10.7	7.3	0.68	5.0	2350
<b>5978001201</b>	<b>29.0±0.65</b> 1.142	<b>19.0±0.5</b> .748	<b>13.85±0.3</b> .545	26	10.7	7.3	0.68	5.0	2695
<b>5943001601</b>	<b>31.1±0.75</b> 1.225	<b>19.05±0.5</b> .750	<b>7.9±0.3</b> .312	18	16.2	7.6	0.47	3.53	530 Min.
5977001601	<b>31.1±0.75</b> 1.225	<b>19.05±0.5</b> .750	<b>7.9±0.3</b> .312	18	16.2	7.6	0.47	3.53	1550
<b>5978001601</b>	<b>31.1±0.75</b> 1.225	<b>19.05±0.5</b> .750	<b>7.9±0.3</b> .312	18	16.2	7.6	0.47	3.53	1780
<b>5961001701</b>	<b>31.75±0.75</b> 1.250	<b>19.05±0.5</b> .750	<b>9.5±0.3</b> .375	23	12.9	7.6	0.59	4.5	120
<b>5943001701</b>	<b>31.75±0.75</b> 1.250	<b>19.05±0.5</b> .750	<b>9.5±0.3</b> .375	23	12.9	7.6	0.59	4.5	660 Min.
5977001701	<b>31.75±0.75</b> 1.250	<b>19.05±0.5</b> .750	<b>9.5±0.3</b> .375	23	12.9	7.6	0.59	4.5	1950
<b>5978001701</b>	<b>31.75±0.75</b> 1.250	<b>19.05±0.5</b> .750	<b>9.5±0.3</b> .375	23	12.9	7.6	0.59	4.5	2230
<b>5961002701</b>	<b>35.55±0.75</b> 1.400	<b>23.0±0.55</b> .900	<b>12.7±0.5</b> .500	33	11.2	8.9	0.79	7.0	140

\* This dimension may be modified to suit specific applications.

\*\* Bold part numbers designate preferred parts.

**Fair-Rite Products Corp.** P.O. Box J, One Commercial Row, Wallkill, NY 12589-0288

Phone: (888) FAIR RITE / (845) 895-2055 • FAX: (888) FERRITE / (845) 895-2629 • www.fair-rite.com • E-Mail: ferrites@fair-rite.com  
(888) 324-7748 (888) 337-7483 Note: (914) Area Code has changed to (845).

# Toroids

Symbols	Definitions
$\Sigma l/A$	Core constant
$l_e$	Effective path length
$A_e$	Effective cross-sectional area
$V_e$	Effective core volume
$A_L$	Inductance factor ( $\frac{l_e}{N^2}$ )

**Dimensions** (Bold numbers are in millimeters, light numbers are nominal in inches.)

Part Number**	A	B	C*	Wt (g)	$\Sigma l/A(\text{cm}^{-1})$	$l_e$ (cm)	$A_e(\text{cm}^2)$	$V_e(\text{cm}^3)$	$A_L(\text{nH})$ $\pm 20\%$
<b>5943002701</b>	<b>35.55±0.75</b> 1.400	<b>23.0±0.55</b> .900	<b>12.7±0.5</b> .500	33	11.2	8.9	0.79	7.0	760 Min.
5977002701	<b>35.55±0.75</b> 1.400	<b>23.0±0.55</b> .900	<b>12.7±0.5</b> .500	33	11.2	8.9	0.79	7.0	2250
<b>5978002701</b>	<b>35.55±0.75</b> 1.400	<b>23.0±0.55</b> .900	<b>12.7±0.5</b> .500	33	11.2	8.9	0.79	7.0	2545
<b>5961003801</b>	<b>61.0±1.3</b> 2.400	<b>35.55±0.85</b> 1.400	<b>12.7±0.5</b> .500	106	9.2	14.5	1.58	22.8	170
<b>5943003801</b>	<b>61.0±1.3</b> 2.400	<b>35.55±0.85</b> 1.400	<b>12.7±0.5</b> .500	106	9.2	14.5	1.58	22.8	930 Min.
5977003801	<b>61.0±1.3</b> 2.400	<b>35.55±0.85</b> 1.400	<b>12.7±0.5</b> .500	106	9.2	14.5	1.58	22.8	2725
<b>5978003801</b>	<b>61.0±1.3</b> 2.400	<b>35.55±0.85</b> 1.400	<b>12.7±0.5</b> .500	106	9.2	14.5	1.58	22.8	3155
<b>5943011101</b>	<b>73.65±1.5</b> 2.900	<b>38.85±0.75</b> 1.530	<b>12.7±0.4</b> .500	188	7.8	16.7	2.15	35.9	1100 Min.
5977011101	<b>73.65±1.5</b> 2.900	<b>38.85±0.75</b> 1.530	<b>12.7±0.4</b> .500	188	7.8	16.7	2.15	35.9	3225
<b>5978011101</b>	<b>73.65±1.5</b> 2.900	<b>38.85±0.75</b> 1.530	<b>12.7±0.4</b> .500	188	7.8	16.7	2.15	35.9	3740

\* This dimension may be modified to suit specific applications.

\*\* Bold part numbers designate preferred parts.

# Pot Cores

The pot core has found wide application in all types of inductive devices. The core configuration provides a high degree of self-shielding. It also facilitates gapping to enhance its utility for a variety of magnetic designs.

- Part number is for a single core.
- Pot cores in 78 material can be supplied with the center post gapped to a mechanical dimension.
- Pot cores in 78 material can also be gapped to an  $A_L$  value. These cores will be supplied as sets.
- Pot cores sets that have an airgap in one of the core halves will be marked with a white marking on the backwall. Cores should be used in sets matching a marked core with an unmarked core. Pot core sets that are gapped symmetrically will not be marked.
- $A_L$  value is measured at 1kHz, <10 gauss.
- See section "The Effect of Direct Current on the Inductance of a Ferrite Core" on page 165 for curves of  $A_L$  vs. gap length.
- The pot cores shown in Figure 1 are in conformance with IEC 60133.
- For any pot core requirement not listed in the catalog, please contact our customer service group for availability and pricing.

**Dimensions** (Bold numbers are in millimeters, light numbers are nominal in inches.)

Part Number*	Fig.	A	B	C	D	E	F	G	H	J Min.
<b>5678090521</b>	1	<b>9.15±0.15</b> .360	<b>2.7 - 0.15</b> .103	<b>6.75±0.25</b> .266	<b>1.8±0.15</b> .074	<b>7.5±0.25</b> .300	<b>3.8±0.1</b> .150	<b>2.0±0.4</b> .079	<b>2.1±0.1</b> .083	-
<b>5678110721</b>	1	<b>11.1±0.2</b> .437	<b>3.3 - 0.15</b> .127	<b>7.25±0.25</b> .285	<b>2.2 + 0.15</b> .090	<b>9.2±0.2</b> .362	<b>4.6±0.1</b> .181	<b>2.5±0.35</b> .105	<b>2.1±0.1</b> .083	-
5677140821	1	<b>14.05±0.25</b> .553	<b>4.25 - 0.15</b> .164	<b>9.5±0.25</b> .374	<b>2.9±0.1</b> .114	<b>11.8±0.2</b> .465	<b>5.9±0.1</b> .232	<b>3.3±0.4</b> .130	<b>3.1±0.1</b> .122	<b>0.2</b> .008
<b>5678140821</b>	1	<b>14.05±0.25</b> .553	<b>4.25 - 0.15</b> .164	<b>9.5±0.25</b> .374	<b>2.9±0.1</b> .114	<b>11.8±0.2</b> .465	<b>5.9±0.1</b> .232	<b>3.3±0.4</b> .130	<b>3.1±0.1</b> .122	<b>0.2</b> .008
5677181121	1	<b>18.0±0.4</b> .709	<b>5.35 - 0.15</b> .208	<b>12.3±0.3</b> .484	<b>3.7±0.1</b> .146	<b>15.15±0.25</b> .596	<b>7.45±0.15</b> .293	<b>3.85±0.6</b> .152	<b>3.1±0.1</b> .122	<b>0.3</b> .012
<b>5678181121</b>	1	<b>18.0±0.4</b> .709	<b>5.35 - 0.15</b> .208	<b>12.3±0.3</b> .484	<b>3.7±0.1</b> .146	<b>15.15±0.25</b> .596	<b>7.45±0.15</b> .293	<b>3.85±0.6</b> .152	<b>3.1±0.1</b> .122	<b>0.3</b> .012
5677221321	1	<b>21.6±0.4</b> .850	<b>6.7±0.1</b> .264	<b>14.9±0.35</b> .587	<b>4.7±0.1</b> .185	<b>18.2±0.3</b> .717	<b>9.25±0.15</b> .364	<b>3.1±0.6</b> .122	<b>4.55±0.15</b> .179	<b>0.4</b> .016
<b>5678221321</b>	1	<b>21.6±0.4</b> .850	<b>6.7±0.1</b> .264	<b>14.9±0.35</b> .587	<b>4.7±0.1</b> .185	<b>18.2±0.3</b> .717	<b>9.25±0.15</b> .364	<b>3.1±0.6</b> .122	<b>4.55±0.15</b> .179	<b>0.4</b> .016
5677261621	1	<b>25.5±0.5</b> 1.004	<b>8.05±0.1</b> .317	<b>18.15±0.4</b> .715	<b>5.6±0.1</b> .220	<b>21.6±0.4</b> .850	<b>11.3±0.2</b> .445	<b>3.6±0.6</b> .142	<b>5.55±0.15</b> .218	<b>0.5</b> .020
<b>5678261621</b>	1	<b>25.5±0.5</b> 1.004	<b>8.05±0.1</b> .317	<b>18.15±0.4</b> .715	<b>5.6±0.1</b> .220	<b>21.6±0.4</b> .850	<b>11.3±0.2</b> .445	<b>3.6±0.6</b> .142	<b>5.55±0.15</b> .218	<b>0.5</b> .020
5677301921	1	<b>30.0±0.5</b> 1.181	<b>9.4±0.1</b> .370	<b>21.5±0.5</b> .846	<b>6.6±0.1</b> .260	<b>25.4±0.4</b> 1.000	<b>13.3±0.2</b> .524	<b>4.2±0.6</b> .165	<b>5.55±0.15</b> .218	<b>0.6</b> .024
<b>5678301921</b>	1	<b>30.0±0.5</b> 1.181	<b>9.4±0.1</b> .370	<b>21.5±0.5</b> .846	<b>6.6±0.1</b> .260	<b>25.4±0.4</b> 1.000	<b>13.3±0.2</b> .524	<b>4.2±0.6</b> .165	<b>5.55±0.15</b> .218	<b>0.6</b> .024
5677362221	1	<b>35.6±0.6</b> 1.402	<b>10.85±0.15</b> .427	<b>26.0±0.5</b> 1.024	<b>7.45±0.15</b> .293	<b>30.4±0.5</b> 1.197	<b>15.9±0.3</b> .626	<b>5.1±0.5</b> .201	<b>5.55±0.15</b> .218	<b>0.6</b> .024
<b>5678362221</b>	1	<b>35.6±0.6</b> 1.402	<b>10.85±0.15</b> .427	<b>26.0±0.5</b> 1.024	<b>7.45±0.15</b> .293	<b>30.4±0.5</b> 1.197	<b>15.9±0.3</b> .626	<b>5.1±0.5</b> .201	<b>5.55±0.15</b> .218	<b>0.6</b> .024

\*Bold part numbers designate preferred parts.

**Fair-Rite Products Corp.** P.O. Box J, One Commercial Row, Wallkill, NY 12589-0288

Phone: (888) FAIR RITE / (845) 895-2055 • FAX: (888) FERRITE / (845) 895-2629 • www.fair-rite.com • E-Mail: ferrites@fair-rite.com  
(888) 324-7748 (888) 337-7483 Note: (914) Area Code has changed to (845).

# Pot Cores

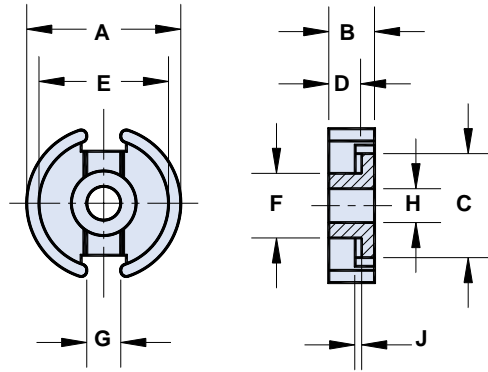


Figure 1

Dimensional letter designations have been changed from the 13th edition catalog and are now in accordance to the MMPA SFG-96.

Symbols	Definitions
$\Sigma l/A$	Core constant
$l_e$	Effective path length
$A_e$	Effective cross-sectional area
$V_e$	Effective core volume
$A_L$	Inductance factor ( $\frac{l_e}{N^2}$ )

## Magnetic Parameters

Part Number	$\Sigma l/A(\text{cm}^{-1})$	$l_e(\text{cm})$	$A_e(\text{cm}^2)$	$V_e(\text{cm}^3)$	$A_{\min}(\text{cm}^2)$	Wt (g)	$A_L(\text{nH})$
<b>5678090521</b>	12.6	1.24	.098	.122	.078	.40	800 Min.
<b>5678110721</b>	10.0	1.59	.159	.252	.131	.75	1220 Min.
5677140821	8.0	2.00	.250	.50	.197	1.9	1450 Min.
<b>5678140821</b>	8.0	2.00	.250	.50	.197	1.9	1575 Min.
5677181121	6.0	2.59	.43	1.12	.360	4.7	2150 Min.
<b>5678181121</b>	6.0	2.59	.43	1.12	.360	4.7	2350 Min.
5677221321	5.0	3.16	.63	2.00	.51	7.2	2725 Min.
<b>5678221321</b>	5.0	3.16	.63	2.00	.51	7.2	3000 Min.
5677261621	4.0	3.76	.93	3.46	.76	12	3525 Min.
<b>5678261621</b>	4.0	3.76	.93	3.46	.76	12	3900 Min.
5677301921	3.30	4.5	1.36	6.1	1.14	19	4425 Min.
<b>5678301921</b>	3.30	4.5	1.36	6.1	1.14	19	4900 Min.
5677362221	2.58	5.2	2.02	10.6	1.74	34	5875 Min.
<b>5678362221</b>	2.58	5.2	2.02	10.6	1.74	34	6550 Min.

# Pot Cores

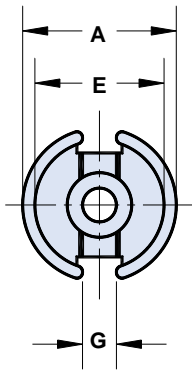


Figure 1

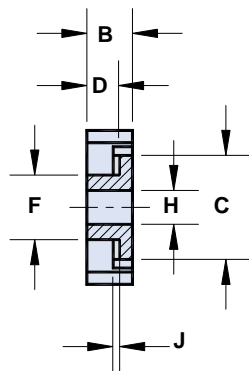


Figure 2

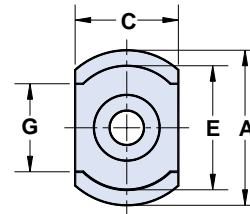
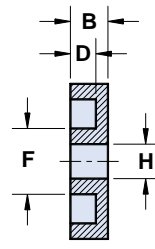
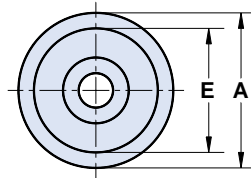
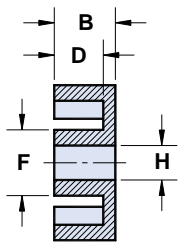


Figure 3



Dimensional letter designations have been changed from the 13th edition catalog and are now in accordance to the MMPA SFG-96.

Dimensions (Bold numbers are in millimeters, light numbers are nominal in inches.)

Part Number*	Fig.	A	B	C	D	E	F	G	H	J Min.
<b>5678422921</b>	1	<b>42.4±0.7</b> 1.669	<b>14.8±0.2</b> .582	<b>32.0±0.7</b> 1.260	<b>10.3±0.15</b> .406	<b>36.3±0.7</b> 1.429	<b>17.4±0.3</b> .685	<b>5.1±0.6</b> .201	<b>5.55±0.15</b> .218	<b>0.95</b> .038
5577000721	2	<b>22.85±0.45</b> .900	<b>9.2 - 0.35</b> .355	-	<b>7.25±0.2</b> .285	<b>18.3±0.35</b> .720	<b>9.7±0.2</b> .382	-	<b>5.1±0.15</b> .200	-
5577000821	3	<b>22.85±0.45</b> .900	<b>9.2 - 0.35</b> .355	<b>15.25±0.25</b> .600	<b>7.25±0.2</b> .285	<b>18.3±0.35</b> .720	<b>9.7±0.2</b> .382	<b>13.0 Min</b> .511	<b>5.1±0.15</b> .200	-
<b>5578000721</b>	2	<b>22.85±0.45</b> .900	<b>9.2 - 0.35</b> .355	-	<b>7.25±0.2</b> .285	<b>18.3±0.35</b> .720	<b>9.7±0.2</b> .382	-	<b>5.1±0.15</b> .200	-
<b>5578000821</b>	3	<b>22.85±0.45</b> .900	<b>9.2 - 0.35</b> .355	<b>15.25±0.25</b> .600	<b>7.25±0.2</b> .285	<b>18.3±0.35</b> .720	<b>9.7±0.2</b> .382	<b>13.0 Min</b> .511	<b>5.1±0.15</b> .200	-
5577000921	2	<b>22.85±0.45</b> .900	<b>5.65 - 0.25</b> .218	-	<b>3.75±0.1</b> .148	<b>18.3±0.35</b> .720	<b>9.7±0.2</b> .382	-	<b>5.1±0.15</b> .200	-
5577001021	3	<b>22.85±0.45</b> .900	<b>5.65 - 0.25</b> .218	<b>15.25±0.25</b> .600	<b>3.75±0.1</b> .148	<b>18.3±0.35</b> .720	<b>9.7±0.2</b> .382	<b>13.0 Min</b> .511	<b>5.1±0.15</b> .200	-
<b>5578000921</b>	2	<b>22.85±0.45</b> .900	<b>5.65 - 0.25</b> .218	-	<b>3.75±0.1</b> .148	<b>18.3±0.35</b> .720	<b>9.7±0.2</b> .382	-	<b>5.1±0.15</b> .200	-
<b>5578001021</b>	3	<b>22.85±0.45</b> .900	<b>5.65 - 0.25</b> .218	<b>15.25±0.25</b> .600	<b>3.75±0.1</b> .148	<b>18.3±0.35</b> .720	<b>9.7±0.2</b> .382	<b>13.0 Min</b> .511	<b>5.1±0.15</b> .200	-

\*Bold part numbers designate preferred parts.



# Pot Cores

Symbols	Definitions
$\Sigma l/A$	Core constant
$l_e$	Effective path length
$A_e$	Effective cross-sectional area
$V_e$	Effective core volume
$A_L$	Inductance factor ( $\frac{l_e}{N^2}$ )

## Magnetic Parameters

Part Number	$\Sigma l/A(\text{cm}^{-1})$	$l_e(\text{cm})$	$A_e(\text{cm}^2)$	$V_e(\text{cm}^3)$	$A_{\min}(\text{cm}^2)$	Wt (g)	$A_L(\text{nH})$
<b>5678422921</b>	2.58	6.9	2.66	18.2	2.10	51	6950 Min.
5577000721	6.75	4.3	.63	2.70	.53	11	2200 Min.
5577000821						7.6	
<b>5578000721</b>	6.75	4.3	.63	2.70	.53	11	2475 Min.
<b>5578000821</b>						7.6	
5577000921	4.54	2.87	.63	1.80	.53	7.3	2925 Min.
5577001021						5.2	
<b>5578000921</b>	4.54	2.87	.63	1.80	.53	7.3	3350 Min.
<b>5578001021</b>						5.2	

# E & I Cores

The E core geometry offers an economical design approach for a wide range of applications.

In a power ferrite, E cores are used in a variety of power designs. In a high permeability material they are utilized for matching, broadband transformers and common mode chokes.

- Part number is for a single core.
- E cores can be supplied with the center post gapped to a mechanical dimension.
- E cores can also be gapped to an  $A_L$  value. These cores will be supplied as sets.
- $A_L$  value is measured at 1kHz, < 10 gauss.
- See section "The Effect of Direct Current on the Inductance of a Ferrite Core" on page 165 for curves of  $A_L$  vs. gap length.
- Fair-Rite equivalents to lamination sizes:
 

E2829 94 - - 019002	E375 94 - - 375002
E187 94 - - 016002	E21 94 - - 500002
E2425 94 - - 015002	E625 94 - - 625002
- For any E or I core requirement not listed in the catalog, please contact our customer service group for availability and pricing.

**Dimensions (Bold numbers are in millimeters, light numbers are nominal in inches.)**

Part Number*	Fig.	A	B	C	D	E Min.	F	Wt (g)
9477019002	1	<b>12.7±0.25</b> .500	<b>5.8 - 0.25</b> .224	<b>3.45 - 0.5</b> .125	<b>4.1±0.15</b> .161	<b>9.3</b> .365	<b>3.3 - 0.25</b> .125	.8
<b>9478019002</b>	1	<b>12.7±0.25</b> .500	<b>5.8 - 0.25</b> .224	<b>3.45 - 0.5</b> .125	<b>4.1±0.15</b> .161	<b>9.3</b> .365	<b>3.3 - 0.25</b> .125	.8
<b>9475019002</b>	1	<b>12.7±0.25</b> .500	<b>5.8 - 0.25</b> .224	<b>3.45 - 0.5</b> .125	<b>4.1±0.15</b> .161	<b>9.3</b> .365	<b>3.3 - 0.25</b> .125	.8
9477020002	1	<b>12.7±0.25</b> .500	<b>5.8 - 0.25</b> .224	<b>6.6 - 0.5</b> .250	<b>4.1±0.15</b> .161	<b>9.3</b> .365	<b>3.3 - 0.25</b> .125	1.5
<b>9478020002</b>	1	<b>12.7±0.25</b> .500	<b>5.8 - 0.25</b> .224	<b>6.6 - 0.5</b> .250	<b>4.1±0.15</b> .161	<b>9.3</b> .365	<b>3.3 - 0.25</b> .125	1.5
<b>9475020002</b>	1	<b>12.7±0.25</b> .500	<b>5.8 - 0.25</b> .224	<b>6.6 - 0.5</b> .250	<b>4.1±0.15</b> .161	<b>9.3</b> .365	<b>3.3 - 0.25</b> .125	1.5
9477016002	1	<b>19.3±0.4</b> .760	<b>8.2 - 0.25</b> .318	<b>4.75±0.20</b> .187	<b>5.6 + 0.25</b> .225	<b>14.3</b> .562	<b>4.95 - 0.35</b> .187	2.4
<b>9478016002</b>	1	<b>19.3±0.4</b> .760	<b>8.2 - 0.25</b> .318	<b>4.75±0.20</b> .187	<b>5.6 + 0.25</b> .225	<b>14.3</b> .562	<b>4.95 - 0.35</b> .187	2.4
<b>9475016002</b>	1	<b>19.3±0.4</b> .760	<b>8.2 - 0.25</b> .318	<b>4.75±0.20</b> .187	<b>5.6 + 0.25</b> .225	<b>14.3</b> .562	<b>4.95 - 0.35</b> .187	2.4
9477012002	1	<b>19.3±0.4</b> .760	<b>8.2 - 0.25</b> .318	<b>9.5±0.25</b> .375	<b>5.6 + 0.25</b> .225	<b>14.3</b> .562	<b>4.95 - 0.35</b> .187	4.8
<b>9478012002</b>	1	<b>19.3±0.4</b> .760	<b>8.2 - 0.25</b> .318	<b>9.5±0.25</b> .375	<b>5.6 + 0.25</b> .225	<b>14.3</b> .562	<b>4.95 - 0.35</b> .187	4.8
<b>9475012002</b>	1	<b>19.3±0.4</b> .760	<b>8.2 - 0.25</b> .318	<b>9.5±0.25</b> .375	<b>5.6 + 0.25</b> .225	<b>14.3</b> .562	<b>4.95 - 0.35</b> .187	4.8
9477015002	1	<b>25.4±0.5</b> 1.000	<b>9.8 - 0.3</b> .380	<b>6.6 - 0.5</b> .250	<b>6.35 + 0.25</b> .255	<b>18.8</b> .740	<b>6.6 - 0.5</b> .250	5.4
<b>9478015002</b>	1	<b>25.4±0.5</b> 1.000	<b>9.8 - 0.3</b> .380	<b>6.6 - 0.5</b> .250	<b>6.35 + 0.25</b> .255	<b>18.8</b> .740	<b>6.6 - 0.5</b> .250	5.4

\*Bold part numbers designate preferred parts.

**Fair-Rite Products Corp.** P.O. Box J, One Commercial Row, Wallkill, NY 12589-0288

Phone: (888) FAIR RITE / (845) 895-2055 • FAX: (888) FERRITE / (845) 895-2629 • www.fair-rite.com • E-Mail: ferrites@fair-rite.com  
(888) 324-7748 (888) 337-7483 **Note: (914) Area Code has changed to (845).**

# E & I Cores

Dimensional letter designations have been changed from the 13th edition catalog and are now in accordance to the MMPA SFG-96.

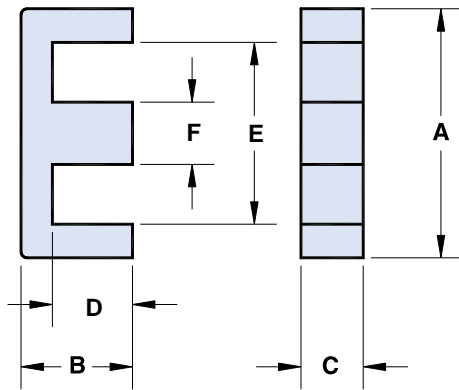


Figure 1

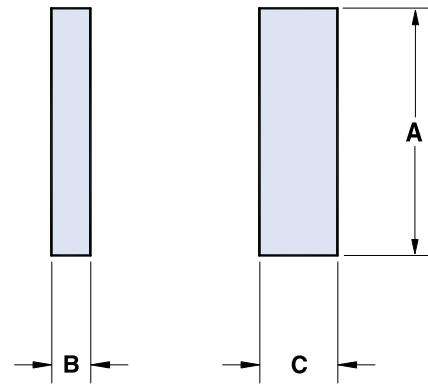


Figure 2

## Magnetic Parameters

Part Number	$\Sigma l/A(\text{cm}^{-1})$	$\ell_e(\text{cm})$	$A_e(\text{cm}^2)$	$V_e(\text{cm}^3)$	$A_L(\text{nH})$
9477019002	27.6	2.77	.101	.279	475 Min.
<b>9478019002</b>	27.6	2.77	.101	.279	525 Min.
<b>9475019002</b>	27.6	2.77	.101	.279	1290±25%
9477020002	13.8	2.77	.202	.56	1000 Min.
<b>9478020002</b>	13.8	2.77	.202	.56	1075 Min.
<b>9475020002</b>	13.8	2.77	.202	.56	2600±25%
9477016002	17.9	4.0	.225	.90	825 Min.
<b>9478016002</b>	17.9	4.0	.225	.90	925 Min.
<b>9475016002</b>	17.9	4.0	.225	.90	2300±25%
9477012002	8.92	4.0	.45	1.80	1700 Min.
<b>9478012002</b>	8.92	4.0	.45	1.80	1900 Min.
<b>9475012002</b>	8.92	4.0	.45	1.80	4600±25%
9477015002	12.06	4.9	.40	1.95	1300 Min.
<b>9478015002</b>	12.06	4.9	.40	1.95	1450 Min.

## Symbols

 $\Sigma l/A$ 
 $\ell_e$ 
 $A_e$ 
 $V_e$ 
 $A_L$ 

## Definitions

Core constant

Effective path length

Effective cross-sectional area

Effective core volume

Inductance factor ( $\frac{l}{N^2}$ )

# E & I Cores

Dimensions (Bold numbers are in millimeters, light numbers are nominal in inches.)

Part Number*	Fig.	A	B	C	D	E Min.	F	Wt (g)
<b>9475015002</b>	1	<b>25.4±0.5</b> 1.000	<b>9.8 - 0.3</b> .380	<b>6.6 - 0.5</b> .250	<b>6.35 + 0.25</b> .255	<b>18.8</b> .740	<b>6.6 - 0.5</b> .250	5.4
9477014002	1	<b>25.4±0.5</b> 1.000	<b>9.8 - 0.3</b> .380	<b>12.7±0.25</b> .500	<b>6.35 + 0.25</b> .255	<b>18.8</b> .740	<b>6.6 - 0.5</b> .250	11
<b>9478014002</b>	1	<b>25.4±0.5</b> 1.000	<b>9.8 - 0.3</b> .380	<b>12.7±0.25</b> .500	<b>6.35 + 0.25</b> .255	<b>18.8</b> .740	<b>6.6 - 0.5</b> .250	11
<b>9475014002</b>	1	<b>25.4±0.5</b> 1.000	<b>9.8 - 0.3</b> .380	<b>12.7±0.25</b> .500	<b>6.35 + 0.25</b> .255	<b>18.8</b> .740	<b>6.6 - 0.5</b> .250	11
9477034002	1	<b>25.4±0.5</b> 1.000	<b>16.0±0.25</b> .630	<b>6.6 - 0.5</b> .250	<b>12.7 + 0.35</b> .507	<b>18.8</b> .740	<b>6.6 - 0.5</b> .250	8.4
<b>9478034002</b>	1	<b>25.4±0.5</b> 1.000	<b>16.0±0.25</b> .630	<b>6.6 - 0.5</b> .250	<b>12.7 + 0.35</b> .507	<b>18.8</b> .740	<b>6.6 - 0.5</b> .250	8.4
9477017002	1	<b>28.0±0.6</b> 1.102	<b>10.6 - 0.25</b> .413	<b>11.2±0.25</b> .440	<b>5.6 + 0.25</b> .225	<b>19.2</b> .756	<b>7.7±0.25</b> .303	13
<b>9478017002</b>	1	<b>28.0±0.6</b> 1.102	<b>10.6 - 0.25</b> .413	<b>11.2±0.25</b> .440	<b>5.6 + 0.25</b> .225	<b>19.2</b> .756	<b>7.7±0.25</b> .303	13
9477375002	1	<b>34.55±0.7</b> 1.360	<b>14.5 - 0.25</b> .567	<b>9.25±0.25</b> .365	<b>9.5 + 0.25</b> .380	<b>25.5</b> 1.004	<b>9.4±0.15</b> .370	16
<b>9478375002</b>	1	<b>34.55±0.7</b> 1.360	<b>14.5 - 0.25</b> .567	<b>9.25±0.25</b> .365	<b>9.5 + 0.25</b> .380	<b>25.5</b> 1.004	<b>9.4±0.15</b> .370	16
9477500002	1	<b>40.75±0.8</b> 1.604	<b>16.5±0.15</b> .650	<b>12.2±0.4</b> .480	<b>10.15 + 0.25</b> .405	<b>27.8</b> 1.095	<b>12.2±0.35</b> .480	30
<b>9478500002</b>	1	<b>40.75±0.8</b> 1.604	<b>16.5±0.15</b> .650	<b>12.2±0.4</b> .480	<b>10.15 + 0.25</b> .405	<b>27.8</b> 1.095	<b>12.2±0.35</b> .480	30
9477036002	1	<b>42.85±0.75</b> 1.687	<b>21.15 - 0.25</b> .828	<b>15.85 - 0.75</b> .609	<b>14.95 + 0.25</b> .593	<b>30.4</b> 1.197	<b>11.9±0.25</b> .468	48
<b>9478036002</b>	1	<b>42.85±0.75</b> 1.687	<b>21.15 - 0.25</b> .828	<b>15.85 - 0.75</b> .609	<b>14.95 + 0.25</b> .593	<b>30.4</b> 1.197	<b>11.9±0.25</b> .468	48
9477625002	1	<b>47.1±0.75</b> 1.855	<b>19.85 - 0.4</b> .773	<b>15.6±0.25</b> .615	<b>12.0+0.25</b> .477	<b>31.6</b> 1.245	<b>15.6±0.25</b> .615	57
<b>9478625002</b>	1	<b>47.1±0.75</b> 1.855	<b>19.85 - 0.4</b> .773	<b>15.6±0.25</b> .615	<b>12.0+0.25</b> .477	<b>31.6</b> 1.245	<b>15.6±0.25</b> .615	57
9377020002	2	<b>25.4±0.6</b> 1.000	<b>3.3 - 0.25</b> .125	<b>6.6 - 0.5</b> .250	-	-	-	2.7
<b>9378020002</b>	2	<b>25.4±0.6</b> 1.000	<b>3.3 - 0.25</b> .125	<b>6.6 - 0.5</b> .250	-	-	-	2.7
<b>9375020002</b>	2	<b>25.4±0.6</b> 1.000	<b>3.3 - 0.25</b> .125	<b>6.6 - 0.5</b> .250	-	-	-	2.7
9377024002	2	<b>25.4±0.6</b> 1.000	<b>6.5 - 0.25</b> .250	<b>6.6 - 0.5</b> .250	-	-	-	5.4
<b>9378024002</b>	2	<b>25.4±0.6</b> 1.000	<b>6.5 - 0.25</b> .250	<b>6.6 - 0.5</b> .250	-	-	-	5.4
9377036002	2	<b>42.85±0.75</b> 1.687	<b>6.1 - 0.25</b> .235	<b>15.85 - 0.75</b> .609	-	-	-	21
<b>9378036002</b>	2	<b>42.85±0.75</b> 1.687	<b>6.1 - 0.25</b> .235	<b>15.85 - 0.75</b> .609	-	-	-	21

\*Bold part numbers designate preferred parts.

**Fair-Rite Products Corp.** P.O. Box J, One Commercial Row, Wallkill, NY 12589-0288

Phone: (888) FAIR RITE / (845) 895-2055 • FAX: (888) FERRITE / (845) 895-2629 • www.fair-rite.com • E-Mail: ferrites@fair-rite.com  
(888) 324-7748 (888) 337-7483 Note: (914) Area Code has changed to (845).

# E & I Cores

## Magnetic Parameters

Part Number	$\Sigma l/A(\text{cm}^{-1})$	$l_e(\text{cm})$	$A_e(\text{cm}^2)$	$V_e(\text{cm}^3)$	$A_L(\text{nH})$	
9475015002	12.06	4.9	.40	1.95	3500±25%	
9477014002	6.03	4.9	.80	3.92	2625 Min.	
9478014002	6.03	4.9	.80	3.92	2950 Min.	
9475014002	6.03	4.9	.80	3.92	7000±25%	
9477034002	18.0	7.3	.40	2.98	870 Min.	
9478034002	18.0	7.3	.40	2.98	990 Min.	
9477017002	5.0	4.8	.96	4.6	3000 Min.	
9478017002	5.0	4.8	.96	4.6	3340 Min.	
9477375002	7.92	6.9	.86	6.0	2050 Min.	
9478375002	7.92	6.9	.86	6.0	2350 Min.	
9477500002	5.12	7.6	1.50	11.5	3225 Min.	
9478500002	5.12	7.6	1.50	11.5	3750 Min.	
9477036002	5.34	9.8	1.84	18.1	3175 Min.	
9478036002	5.34	9.8	1.84	18.1	3600 Min.	
9477625002	3.74	8.9	2.37	21.1	4500 Min.	
9478625002	3.74	8.9	2.37	21.1	5100 Min.	
9377020002	8.82	3.56	.40	1.44	1575 Min.	with 9477015002, page 146
9378020002	8.82	3.56	.40	1.44	1725 Min.	with 9478015002, page 146
9375020002	8.82	3.56	.40	1.44	4200±25%	with 9475015002, page 148
9377024002**	8.64	3.48	.40	1.41	1700 Min.	with 9477015002, page 146
9378024002**	8.64	3.48	.40	1.41	1950 Min.	with 9478015002, page 146
9377036002	3.68	6.8	1.84	12.5	4275 Min.	with 9477036002, page 148
9378036002	3.68	6.8	1.84	12.5	4800 Min.	with 9478036002, page 148

Symbols	Definitions
$\Sigma l/A$	Core constant
$l_e$	Effective path length
$A_e$	Effective cross-sectional area
$V_e$	Effective core volume
$A_L$	Inductance factor ( $\frac{L}{N^2}$ )

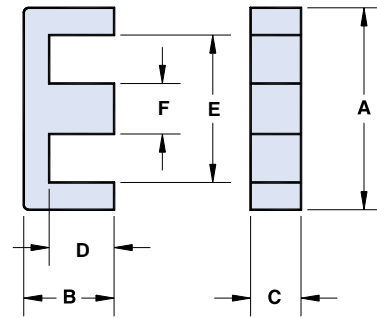


Figure 1

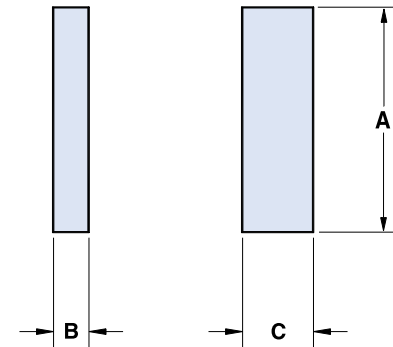


Figure 2

Dimensional letter designations have been changed from the 13th edition catalog and are now in accordance to the MMPA SFG-96.

\*\* May be used with U cores, see page 152.

# ETD Cores

ETD cores have been designed to make optimum use of a given volume of ferrite material for maximum throughput power, specifically for forward converter transformers. Their structure, which includes a round center post, approaches a nearly uniform cross-sectional area throughout the core and provides a winding area that minimizes winding losses.

ETD cores are used mainly in switched-mode power supplies and permit off-line designs where IEC and VDE isolation requirements must be met.

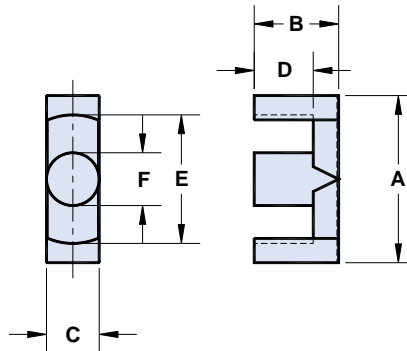
- Part number is for a single core.
- ETD cores can be supplied with the center post gapped to a mechanical dimension.
- ETD cores can also be gapped to an  $A_L$  value. These cores will be supplied as sets.
- $A_L$  value is measured at 1kHz, <10 gauss.
- See section "The Effect of Direct Current on the Inductance of a Ferrite Core" on page 165 for curves of  $A_L$  vs. gap length.
- The ETD cores are in conformance with IEC 61185.
- For any ETD core requirement not listed in the catalog, please contact our customer service group for availability and pricing.

**Dimensions (Bold numbers are in millimeters, light numbers are nominal in inches.)**

Part Number *	A	B	C	D	E	F	Wt (g)
<b>9578290002</b>	<b>29.8±0.8</b> 1.173	<b>15.8±0.2</b> .622	<b>9.5±0.3</b> .374	<b>11.0±0.3</b> .433	<b>22.7±0.7</b> .894	<b>9.5±0.3</b> .374	14
9577340002	<b>34.2±0.8</b> 1.346	<b>17.3±0.2</b> .681	<b>10.8±0.3</b> .425	<b>12.1±0.3</b> .476	<b>26.3±0.7</b> 1.035	<b>10.8±0.3</b> .425	22
<b>9578340002</b>	<b>34.2±0.8</b> 1.346	<b>17.3±0.2</b> .681	<b>10.8±0.3</b> .425	<b>12.1±0.3</b> .476	<b>26.3±0.7</b> 1.035	<b>10.8±0.3</b> .425	22
9577390002	<b>39.1±0.9</b> 1.539	<b>19.8±0.2</b> .780	<b>12.5±0.3</b> .492	<b>14.6±0.4</b> .575	<b>30.1±0.8</b> 1.185	<b>12.5±0.3</b> .492	32
<b>9578390002</b>	<b>39.1±0.9</b> 1.539	<b>19.8±0.2</b> .780	<b>12.5±0.3</b> .492	<b>14.6±0.4</b> .575	<b>30.1±0.8</b> 1.185	<b>12.5±0.3</b> .492	32
9577440002	<b>44.0±1.0</b> 1.732	<b>22.3±0.2</b> .878	<b>14.8±0.4</b> .583	<b>16.5±0.4</b> .650	<b>33.3±0.8</b> 1.311	<b>14.8±0.4</b> .583	52
<b>9578440002</b>	<b>44.0±1.0</b> 1.732	<b>22.3±0.2</b> .878	<b>14.8±0.4</b> .583	<b>16.5±0.4</b> .650	<b>33.3±0.8</b> 1.311	<b>14.8±0.4</b> .583	52
9577490002	<b>48.7±1.1</b> 1.917	<b>24.7±0.2</b> .972	<b>16.3±0.4</b> .642	<b>18.1±0.4</b> .713	<b>37.0±0.9</b> 1.457	<b>16.3±0.4</b> .642	65
<b>9578490002</b>	<b>48.7±1.1</b> 1.917	<b>24.7±0.2</b> .972	<b>16.3±0.4</b> .642	<b>18.1±0.4</b> .713	<b>37.0±0.9</b> 1.457	<b>16.3±0.4</b> .642	65

\* Bold part numbers designate preferred parts.

# ETD Cores



Dimensional letter designations have been changed from the 13th edition catalog and are now in accordance to the MMPA SFG-96.

Symbols	Definitions
$\Sigma l/A$	Core constant
$l_e$	Effective path length
$A_e$	Effective cross-sectional area
$V_e$	Effective core volume
$A_L$	Inductance factor ( $\frac{L}{N^2}$ )

## Magnetic Parameters

Part Number	$\Sigma l/A(\text{cm}^{-1})$	$l_e(\text{cm})$	$A_e(\text{cm}^2)$	$V_e(\text{cm}^3)$	$A_{\min}(\text{cm}^2)$	$A_L(\text{nH})$
<b>9578290002</b>	9.5	7.2	.76	5.5	.71	1760 Min.
9577340002	8.1	7.9	.97	7.6	.92	1875 Min.
<b>9578340002</b>	8.1	7.9	.97	7.6	.92	2100 Min.
9577390002	7.4	9.2	1.25	11.5	1.23	2100 Min.
<b>9578390002</b>	7.4	9.2	1.25	11.5	1.23	2360 Min.
9577440002	5.9	10.3	1.73	17.8	1.72	2625 Min.
<b>9578440002</b>	5.9	10.3	1.73	17.8	1.72	2925 Min.
9577490002	5.4	11.4	2.11	24.1	2.09	3000 Min.
<b>9578490002</b>	5.4	11.4	2.11	24.1	2.09	3375 Min.

# U Cores

The U core offers an economical core design with a nearly uniform cross-sectional area.

In a power ferrite material they are frequently used in output chokes, power input filters and transformers for switched-mode power supplies and HF fluorescent ballasts.

- Part number is for a single core.
- These U cores have the same minimum cross-sectional area as the listed effective cross-sectional area.
- $A_L$  value is measured at 1kHz, < 10 gauss.
- For any U core requirement not listed in the catalog, please contact our customer service group for availability and pricing.

**Dimensions (Bold numbers are in millimeters, light numbers are nominal in inches.)**

Part Number*	Fig.	A	B	C	D Min.	E Min.	F	Wt (g)
<b>9077002002</b>	1	<b>8.9 - 0.5</b> .340	<b>4.45±0.25</b> .180	<b>4.05±0.2</b> .160	<b>1.3</b> .051	<b>2.3</b> .090	-	.7
<b>9077026002<sup>†</sup></b>	1	<b>25.4±0.75</b> 1.000	<b>12.6±0.25</b> .500	<b>6.6 - 0.5</b> .250	<b>6.2</b> .244	<b>12.45</b> .490	-	9.0
<b>9077025002<sup>†</sup></b>	1	<b>25.4±0.75</b> 1.000	<b>15.75±0.25</b> .625	<b>6.6 - 0.5</b> .250	<b>9.4</b> .370	<b>12.45</b> .490	-	9.0
<b>9077024002<sup>†</sup></b>	1	<b>25.4±0.75</b> 1.000	<b>18.9±0.25</b> .750	<b>6.6 - 0.5</b> .250	<b>12.55</b> .494	<b>12.45</b> .490	-	10
<b>9277023002</b>	2	<b>26.5±0.7</b> 1.045	<b>15.75±0.25</b> .625	<b>10.0 - 0.5</b> .385	<b>10.0</b> .394	<b>7.25</b> .285	-	14
<b>9277002002</b>	2	<b>26.5±0.7</b> 1.045	<b>20.2±0.15</b> .795	<b>10.0 - 0.5</b> .385	<b>14.35</b> .565	<b>7.25</b> .285	-	17
<b>9277024002</b>	3	<b>31.4±0.6</b> 1.237	<b>18.5±0.15</b> .729	<b>10.25 - 0.5</b> .394	<b>9.4</b> .370	<b>12.5</b> .492	<b>26.6±0.5</b> 1.047	18
<b>9277008002</b>	3	<b>41.15±0.75</b> 1.620	<b>17.45±0.15</b> .687	<b>11.7±0.25</b> .460	<b>7.8</b> .307	<b>18.65</b> .735	<b>35.3±0.6</b> 1.390	26
<b>9277010002</b>	3	<b>41.15±0.75</b> 1.620	<b>20.5±0.25</b> .812	<b>11.7±0.25</b> .460	<b>10.95</b> .431	<b>18.65</b> .735	<b>35.3±0.6</b> 1.390	29
<b>9277012002</b>	3	<b>41.15±0.75</b> 1.620	<b>25.4±0.15</b> 1.000	<b>11.7±0.25</b> .460	<b>15.75</b> .620	<b>18.65</b> .735	<b>35.3±0.6</b> 1.390	34

\* Bold part numbers designate preferred parts.

† An I core, 9377024002, is available for these U cores, see page 148.



# U Cores

Symbols	Definitions
$\Sigma l/A$	Core constant
$l_e$	Effective path length
$A_e$	Effective cross-sectional area
$V_e$	Effective core volume
$A_L$	Inductance factor ( $\frac{l_e}{N^2}$ )

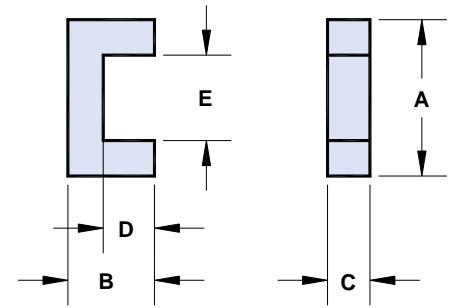


Figure 1

### Magnetic Parameters

Part Number	$\Sigma l/A(\text{cm}^{-1})$	$l_e(\text{cm})$	$A_e(\text{cm}^2)$	$V_e(\text{cm}^3)$	$A_L(\text{nH})$
9077002002	16.8	2.08	.124	.257	695 Min.
9077026002	17.6	7.1	.40	2.85	940 Min.
9077025002	20.7	8.4	.40	3.36	790 Min.
9077024002	23.9	9.6	.40	3.88	695 Min.
9277023002	11.6	7.8	.67	5.2	1390 Min.
9277002002	13.9	9.5	.68	6.5	1180 Min.
9277024002	11.2	9.3	.83	7.7	1425 Min.
9277008002	10.5	10.3	.98	10.1	1575 Min.
9277010002	11.8	11.6	.98	11.3	1425 Min.
9277012002	13.8	13.5	.98	13.2	1255 Min.

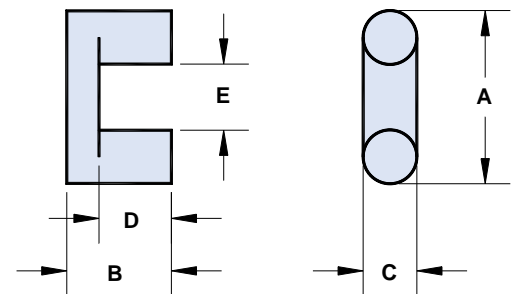


Figure 2

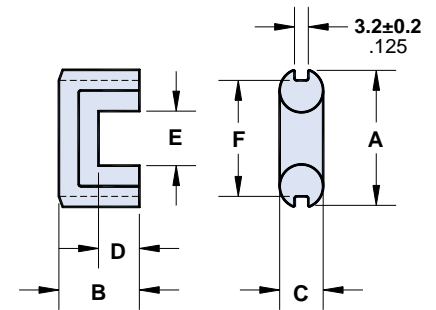


Figure 3

# PQ Cores

The PQ core was developed for use in power applications. The large core surface area for the volume of the core aids in heat dissipation.

These cores are employed both in filter and transformer designs in switched-mode power supplies.

- Part number is for a single core.
- PQ cores can be supplied with the center post gapped to a mechanical dimension.
- PQ cores can also be gapped to an  $A_L$  value. These cores will be supplied as sets.
- $A_L$  value is measured at 1kHz, <10 gauss.
- See section "The Effect of Direct Current on the Inductance of a Ferrite Core" on page 165 for curves of  $A_L$  vs. gap length.
- For any PQ core requirement not listed in the catalog, please contact our customer service group for availability and pricing.

**Dimensions (Bold numbers are in millimeters, light numbers are nominal in inches.)**

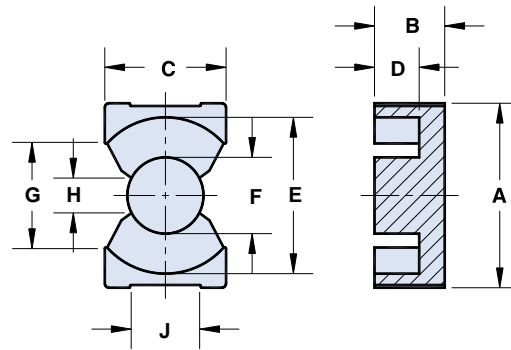
Part Number *	A	B	C	D	E	F	G Min.	H Min.	J
6677201621	<b>21.25±0.4</b> .837	<b>8.1±0.1</b> .319	<b>14.0±0.4</b> .551	<b>5.0+0.3</b> .203	<b>18.0±0.4</b> .709	<b>8.8±0.2</b> .346	<b>12.0</b> .472	<b>4.0</b> .158	<b>8.4-0.5</b> .321
<b>6678201621</b>	<b>21.25±0.4</b> .837	<b>8.1±0.1</b> .319	<b>14.0±0.4</b> .551	<b>5.0+0.3</b> .203	<b>18.0±0.4</b> .709	<b>8.8±0.2</b> .346	<b>12.0</b> .472	<b>4.0</b> .158	<b>8.4-0.5</b> .321
6677202021	<b>21.25±0.4</b> .837	<b>10.1±0.1</b> .398	<b>14.0±0.4</b> .551	<b>7.0+0.3</b> .281	<b>18.0±0.4</b> .709	<b>8.8±0.2</b> .346	<b>12.0</b> .472	<b>4.0</b> .158	<b>8.4-0.5</b> .321
<b>6678202021</b>	<b>21.25±0.4</b> .837	<b>10.1±0.1</b> .398	<b>14.0±0.4</b> .551	<b>7.0+0.3</b> .281	<b>18.0±0.4</b> .709	<b>8.8±0.2</b> .346	<b>12.0</b> .472	<b>4.0</b> .158	<b>8.4-0.5</b> .321
6677262021	<b>27.25±0.45</b> 1.073	<b>10.2-0.25</b> .397	<b>19.0±0.45</b> .748	<b>5.6+0.3</b> .226	<b>22.5±0.45</b> .886	<b>12.0±0.2</b> .472	<b>15.5</b> .610	<b>6.0</b> .236	<b>11.0-0.5</b> .423
<b>6678262021</b>	<b>27.25±0.45</b> 1.073	<b>10.2-0.25</b> .397	<b>19.0±0.45</b> .748	<b>5.6+0.3</b> .226	<b>22.5±0.45</b> .886	<b>12.0±0.2</b> .472	<b>15.5</b> .610	<b>6.0</b> .236	<b>11.0-0.5</b> .423
6677262521	<b>27.25±0.45</b> 1.073	<b>12.5-0.25</b> .487	<b>19.0±0.45</b> .748	<b>7.9+0.3</b> .317	<b>22.5±0.45</b> .886	<b>12.0±0.2</b> .472	<b>15.5</b> .610	<b>6.0</b> .236	<b>11.0-0.5</b> .423
<b>6678262521</b>	<b>27.25±0.45</b> 1.073	<b>12.5-0.25</b> .487	<b>19.0±0.45</b> .748	<b>7.9+0.3</b> .317	<b>22.5±0.45</b> .886	<b>12.0±0.2</b> .472	<b>15.5</b> .610	<b>6.0</b> .236	<b>11.0-0.5</b> .423
6677322021	<b>33.0±0.5</b> 1.300	<b>10.4-0.25</b> .406	<b>22.0±0.5</b> .866	<b>5.6+0.3</b> .226	<b>27.5±0.5</b> 1.083	<b>13.45±0.25</b> .530	<b>19.0</b> .748	<b>5.5</b> .216	<b>12.8-0.5</b> .494
<b>6678322021</b>	<b>33.0±0.5</b> 1.300	<b>10.4-0.25</b> .406	<b>22.0±0.5</b> .866	<b>5.6+0.3</b> .226	<b>27.5±0.5</b> 1.083	<b>13.45±0.25</b> .530	<b>19.0</b> .748	<b>5.5</b> .216	<b>12.8-0.5</b> .494
6677323021	<b>33.0±0.5</b> 1.300	<b>15.3-0.25</b> .597	<b>22.0±0.5</b> .866	<b>10.5+0.3</b> .419	<b>27.5±0.5</b> 1.083	<b>13.45±0.25</b> .530	<b>19.0</b> .748	<b>5.5</b> .216	<b>12.8-0.5</b> .494
<b>6678323021</b>	<b>33.0±0.5</b> 1.300	<b>15.3-0.25</b> .597	<b>22.0±0.5</b> .866	<b>10.5+0.3</b> .419	<b>27.5±0.5</b> 1.083	<b>13.45±0.25</b> .530	<b>19.0</b> .748	<b>5.5</b> .216	<b>12.8-0.5</b> .494
6677353521	<b>36.1±0.6</b> 1.422	<b>17.5-0.25</b> .684	<b>26.0±0.5</b> 1.024	<b>12.35+0.3</b> .492	<b>32.0±0.5</b> 1.260	<b>14.35±0.25</b> .565	<b>23.5</b> .925	<b>5.95</b> .234	<b>13.1-0.5</b> .506
<b>6678353521</b>	<b>36.1±0.6</b> 1.422	<b>17.5-0.25</b> .684	<b>26.0±0.5</b> 1.024	<b>12.35+0.3</b> .492	<b>32.0±0.5</b> 1.260	<b>14.35±0.25</b> .565	<b>23.5</b> .925	<b>5.95</b> .234	<b>13.1-0.5</b> .506
6677404021	<b>41.5±0.9</b> 1.633	<b>20.0-0.25</b> .782	<b>28.0±0.6</b> 1.102	<b>14.6+0.3</b> .581	<b>37.0±0.6</b> 1.457	<b>14.9±0.3</b> .587	<b>28.0</b> 1.102	<b>6.35</b> .250	<b>13.6±0.25</b> .535
<b>6678404021</b>	<b>41.5±0.9</b> 1.633	<b>20.0-0.25</b> .782	<b>28.0±0.6</b> 1.102	<b>14.6+0.3</b> .581	<b>37.0±0.6</b> 1.457	<b>14.9±0.3</b> .587	<b>28.0</b> 1.102	<b>6.35</b> .250	<b>13.6±0.25</b> .535

\*Bold part numbers designate preferred parts.

**Fair-Rite Products Corp.** P.O. Box J, One Commercial Row, Wallkill, NY 12589-0288

Phone: (888) FAIR RITE / (845) 895-2055 • FAX: (888) FERRITE / (845) 895-2629 • www.fair-rite.com • E-Mail: ferrites@fair-rite.com  
(888) 324-7748 (888) 337-7483 **Note: (914) Area Code has changed to (845).**

# PQ Cores



Symbols	Definitions
$\Sigma l/A$	Core constant
$l_e$	Effective path length
$A_e$	Effective cross-sectional area
$V_e$	Effective core volume
$A_L$	Inductance factor ( $\frac{l_e}{N^2}$ )

Dimensional letter designations have been changed from the 13th edition catalog and are now in accordance to the MMPA SFG-96.

## Magnetic Parameters

Part Number	$\Sigma l/A(\text{cm}^{-1})$	$l_e(\text{cm})$	$A_e(\text{cm}^2)$	$V_e(\text{cm}^3)$	$A_{\min}(\text{cm}^2)$	Wt (g)	$A_L(\text{nH})$
6677201621	6.03	3.74	0.62	2.3	0.58	7.2	2550 Min.
<b>6678201621</b>	6.03	3.74	0.62	2.3	0.58	7.2	2850 Min.
6677202021	7.42	4.6	0.62	2.82	0.58	8.3	2175 Min.
<b>6678202021</b>	7.42	4.6	0.62	2.82	0.58	8.3	2360 Min.
6677262021	3.87	4.6	1.19	5.5	1.09	16	4050 Min.
<b>6678262021</b>	3.87	4.6	1.19	5.5	1.09	16	4575 Min.
6677262521	4.71	5.6	1.18	6.6	1.09	19	3450 Min.
<b>6678262521</b>	4.71	5.6	1.18	6.6	1.09	19	3800 Min.
6677322021	3.29	5.6	1.7	9.5	1.37	22	5025 Min.
<b>6678322021</b>	3.29	5.6	1.7	9.5	1.37	22	5425 Min.
6677323021	4.66	7.5	1.61	12.7	1.37	30	3550 Min.
<b>6678323021</b>	4.66	7.5	1.61	12.7	1.37	30	3825 Min.
6677353521	4.49	8.8	1.96	17.2	1.56	37	3600 Min.
<b>6678353521</b>	4.49	8.8	1.96	17.2	1.56	37	3900 Min.
6677404021	5.07	10.2	2.01	20.5	1.67	50	3225 Min.
<b>6678404021</b>	5.07	10.2	2.01	20.5	1.67	50	3475 Min.

# EP Cores

The EP core design reduces the effect of residual air gap upon the effective permeability of the core, hence it minimizes coil volume for a given inductance.

Also, the core geometry provides a high degree of isolation from adjacent components. EP cores are advantageously used in low power devices, matching and broadband transformers.

- Part number is for a single core.
- EP cores can be supplied with the center post gapped to a mechanical dimension.
- EP cores can also be gapped to an  $A_L$  value. These cores will be supplied as sets.
- $A_L$  value is measured at 1kHz, <10 gauss.
- See section "The Effect of Direct Current on the Inductance of a Ferrite Core" on page 165 for curves of  $A_L$  vs. gap length.
- The EP cores are in conformance with IEC 61596.
- For any EP core requirement not listed in the catalog, please contact our customer service group for availability and pricing.

**Dimensions (Bold numbers are in millimeters, light numbers are nominal in inches.)**

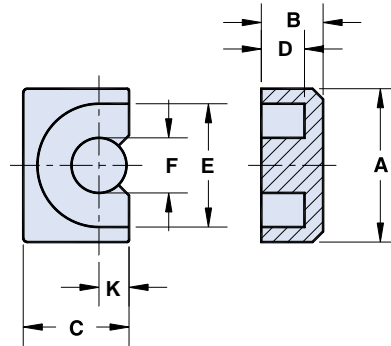
Part Number *	A	B	C	D	E	F	K Max.	Wt (g)
6577070721	<b>9.2±0.2</b> .362	<b>3.7±0.05</b> .146	<b>6.35±0.15</b> .250	<b>2.6±0.1</b> .102	<b>7.4±0.2</b> .291	<b>3.3±0.1</b> .130	<b>1.8</b> .071	.8
<b>6578070721</b>	<b>9.2±0.2</b> .362	<b>3.7±0.05</b> .146	<b>6.35±0.15</b> .250	<b>2.6±0.1</b> .102	<b>7.4±0.2</b> .291	<b>3.3±0.1</b> .130	<b>1.8</b> .071	.8
<b>6575070721</b>	<b>9.2±0.2</b> .362	<b>3.7±0.05</b> .146	<b>6.35±0.15</b> .250	<b>2.6±0.1</b> .102	<b>7.4±0.2</b> .291	<b>3.3±0.1</b> .130	<b>1.8</b> .071	.8
6577101021	<b>11.5±0.3</b> .453	<b>5.1±0.1</b> .201	<b>7.65±0.2</b> .301	<b>3.7±0.1</b> .146	<b>9.4±0.2</b> .370	<b>3.3±0.15</b> .130	<b>1.95</b> .077	1.5
<b>6578101021</b>	<b>11.5±0.3</b> .453	<b>5.1±0.1</b> .201	<b>7.65±0.2</b> .301	<b>3.7±0.1</b> .146	<b>9.4±0.2</b> .370	<b>3.3±0.15</b> .130	<b>1.95</b> .077	1.5
<b>6575101021</b>	<b>11.5±0.3</b> .453	<b>5.1±0.1</b> .201	<b>7.65±0.2</b> .301	<b>3.7±0.1</b> .146	<b>9.4±0.2</b> .370	<b>3.3±0.15</b> .130	<b>1.95</b> .077	1.5
6577131321	<b>12.5±0.3</b> .492	<b>6.5 - 0.15</b> .253	<b>8.8±0.2</b> .346	<b>4.6±0.1</b> .181	<b>10.0±0.3</b> .394	<b>4.35±0.15</b> .171	<b>2.5</b> .098	2.5
<b>6578131321</b>	<b>12.5±0.3</b> .492	<b>6.5 - 0.15</b> .253	<b>8.8±0.2</b> .346	<b>4.6±0.1</b> .181	<b>10.0±0.3</b> .394	<b>4.35±0.15</b> .171	<b>2.5</b> .098	2.5
<b>6575131321</b>	<b>12.5±0.3</b> .492	<b>6.5 - 0.15</b> .253	<b>8.8±0.2</b> .346	<b>4.6±0.1</b> .181	<b>10.0±0.3</b> .394	<b>4.35±0.15</b> .171	<b>2.5</b> .098	2.5
6577171721	<b>18.0±0.5</b> .709	<b>8.4±0.1</b> .331	<b>11.0±0.25</b> .433	<b>5.65±0.15</b> .222	<b>12.0±0.4</b> .472	<b>5.85 - 0.35</b> .223	<b>3.45</b> .136	6.4
<b>6578171721</b>	<b>18.0±0.5</b> .709	<b>8.4±0.1</b> .331	<b>11.0±0.25</b> .433	<b>5.65±0.15</b> .222	<b>12.0±0.4</b> .472	<b>5.85 - 0.35</b> .223	<b>3.45</b> .136	6.4
<b>6575171721</b>	<b>18.0±0.5</b> .709	<b>8.4±0.1</b> .331	<b>11.0±0.25</b> .433	<b>5.65±0.15</b> .222	<b>12.0±0.4</b> .472	<b>5.85 - 0.35</b> .223	<b>3.45</b> .136	6.4
6577202021	<b>24.0±0.5</b> .945	<b>10.7±0.1</b> .421	<b>14.95±0.35</b> .589	<b>7.15±0.15</b> .281	<b>16.5±0.4</b> .650	<b>8.75±0.25</b> .344	<b>4.7</b> .185	15
<b>6578202021</b>	<b>24.0±0.5</b> .945	<b>10.7±0.1</b> .421	<b>14.95±0.35</b> .589	<b>7.15±0.15</b> .281	<b>16.5±0.4</b> .650	<b>8.75±0.25</b> .344	<b>4.7</b> .185	15
<b>6575202021</b>	<b>24.0±0.5</b> .945	<b>10.7±0.1</b> .421	<b>14.95±0.35</b> .589	<b>7.15±0.15</b> .281	<b>16.5±0.4</b> .650	<b>8.75±0.25</b> .344	<b>4.7</b> .185	15

\*Bold part numbers designate preferred parts.

**Fair-Rite Products Corp.** P.O. Box J, One Commercial Row, Wallkill, NY 12589-0288

Phone: (888) FAIR RITE / (845) 895-2055 • FAX: (888) FERRITE / (845) 895-2629 • www.fair-rite.com • E-Mail: ferrites@fair-rite.com  
(888) 324-7748 (888) 337-7483 **Note: (914) Area Code has changed to (845).**

# EP Cores



Symbols	Definitions
$\Sigma l/A$	Core constant
$l_e$	Effective path length
$A_e$	Effective cross-sectional area
$V_e$	Effective core volume
$A_L$	Inductance factor ( $\frac{l_e}{N^2}$ )

Dimensional letter designations have been changed from the 13<sup>th</sup> edition catalog and are now in accordance to the MMPA SFG-96.

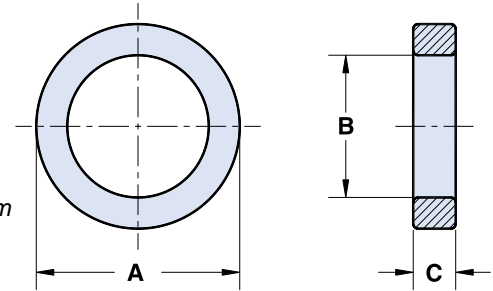
## Magnetic Parameters

Part Number	$\Sigma l/A(\text{cm}^{-1})$	$l_e(\text{cm})$	$A_e(\text{cm}^2)$	$V_e(\text{cm}^3)$	$A_{\min}(\text{cm}^2)$	$A_L(\text{nH})$
6577070721	15.2	1.57	0.103	0.163	0.085	825 Min.
<b>6578070721</b>	15.2	1.57	0.103	0.163	0.085	825 Min.
<b>6575070721</b>	15.2	1.57	0.103	0.163	0.085	1900 Min.
6577101021	17.0	1.93	0.113	0.217	0.085	790 Min.
<b>6578101021</b>	17.0	1.93	0.113	0.217	0.085	790 Min.
<b>6575101021</b>	17.0	1.93	0.113	0.217	0.085	1900 Min.
6577131321	12.4	2.42	0.195	0.47	0.148	1200 Min.
<b>6578131321</b>	12.4	2.42	0.195	0.47	0.148	1200 Min.
<b>6575131321</b>	12.4	2.42	0.195	0.47	0.148	2800 Min.
6577171721	8.4	2.85	0.339	0.97	0.252	1875 Min.
<b>6578171721</b>	8.4	2.85	0.339	0.97	0.252	1875 Min.
<b>6575171721</b>	8.4	2.85	0.339	0.97	0.252	4400 Min.
6577202021	5.1	4.0	0.78	3.12	0.60	3150 Min.
<b>6578202021</b>	5.1	4.0	0.78	3.12	0.60	3150 Min.
<b>6575202021</b>	5.1	4.0	0.78	3.12	0.60	7200 Min.

# 85 Material Toroids

A high frequency, square loop material with optimized characteristics to make this the ferrite of choice for use in magnetic amplifiers and saturable reactors for switch mode applications.

- All toroidal cores are supplied burnished to break the sharp edges.
- Toroids in 85 material are specified to a squareness ratio and not specified to an  $A_L$  value.
- Toroids with an outside diameter of **9.5mm (.375")** or larger can be supplied with a uniform coating of a white thermo-set plastic coating. This coating will increase the "A" and "C" dimensions and decrease the "B" dimension a maximum of **.25mm (.010")**. The 9<sup>th</sup> digit of a thermo-set plastic coated toroid part number is a "2".
- Thermo-set plastic coated parts can withstand a minimum breakdown voltage of 1000Vrms, uniformly applied across the "C" dimension of the core.
- Toroids with a diameter of **9.5mm (.375")** or smaller can be supplied Parylene C coated. This coating will increase the "A" and "C" dimensions and decrease the "B" dimension a maximum of **.038mm (.0015")**. The 9<sup>th</sup> digit of a Parylene coated toroid part number is a "1". See page 159 for material characteristics of Parylene C.
- For any toroid requirement not listed in the catalog, please contact our customer service group for availability and pricing.



**Dimensions** (Bold numbers are in millimeters, light numbers are nominal in inches.)

Part Number ***	A	B	C*	Wt (g)	Radial Resonant Frequency** (kHz)	$\Sigma l/A$ (cm <sup>-1</sup> )	$l_e$ (cm)	$A_e$ (cm <sup>2</sup> )	$V_e$ (cm <sup>3</sup> )
<b>5985010101</b>	2.55±0.1 .100	1.2±0.15 .050	1.35-0.15 .050	.02	984	71.3	0.56	0.0078	0.0043
<b>5985010201</b>	3.5±0.1 .138	1.7±0.15 .070	1.35-0.15 .050	.05	687	72.3	0.77	0.011	0.0081
<b>5985000801</b>	3.95±0.15 .155	2.15-0.15 .088	1.35-0.15 .050	.06	589	87.6	0.92	0.011	0.0097
<b>5985002101</b>	4.95-0.25 .190	2.2±0.15 .090	1.35-0.15 .050	.09	510	69.2	1.04	0.015	0.0157
<b>5985000101</b>	5.95-0.25 .230	3.05±0.1 .120	1.65-0.25 .060	.14	408	63.8	1.30	0.020	0.027
<b>5985015501</b>	6.35±0.2 .250	3.2±0.2 .125	12.7±0.35 .500	1.5	381	7.14	1.38	0.194	0.27
<b>5985000201</b>	9.5±0.2 .375	4.75±0.15 .187	3.3-0.25 .125	.83	254	28.6	2.07	0.072	0.15
<b>5985016001</b>	9.5±0.2 .375	5.7±0.2 .224	3.3-0.25 .125	.70	239	38.4	2.29	0.059	0.136
<b>5985001101</b>	12.7±0.25 .500	7.9±0.20 .312	6.35±0.25 .250	2.4	176	20.8	3.12	0.150	0.47
<b>5985013501</b>	14.0±0.25 .551	9.0±0.3 .354	5.0±0.15 .197	2.2	158	28.4	3.50	0.123	0.43
<b>5985004901</b>	16.0±0.4 .630	9.6±0.3 .378	6.35±0.25 .250	4.0	142	19.4	3.85	0.199	0.77
<b>5985001801</b>	22.1±0.4 .870	13.7±0.3 .540	6.35±0.25 .250	7.2	101	20.7	5.4	0.262	1.42
<b>5985001301</b>	25.4±0.6 1.000	15.5±0.5 .610	6.35±0.25 .250	9.6	89	20.0	6.2	0.308	1.90

\* This dimension may be modified to suit specific applications.

\*\* It is not advised to drive the toroidal cores within 10% of their radial resonant frequency. Cracks or even breakage of the cores could result.

\*\*\*Bold part numbers designate preferred parts.

**Fair-Rite Products Corp.** P.O. Box J, One Commercial Row, Wallkill, NY 12589-0288

Phone: (888) FAIR RITE / (845) 895-2055 • FAX: (888) FERRITE / (845) 895-2629 • www.fair-rite.com • E-Mail: ferrites@fair-rite.com  
(888) 324-7748 (888) 337-7483 **Note: (914) Area Code has changed to (845).**

# Reference Tables

## Ferrite Material Constants

Specific Heat .....	.25 cal/g/°C
Thermal Conductivity .....	10x10 <sup>-3</sup> cal/sec/cm/°C
Coefficient of Linear Expansion .....	8 - 10x10 <sup>-6</sup> /°C
Tensile Strength .....	4.9 kgf/mm <sup>2</sup>
Compressive Strength .....	42 kgf/mm <sup>2</sup>
Young's Modulus .....	15x10 <sup>3</sup> kgf/mm <sup>2</sup>
Hardness (Knoop) .....	650
Specific Gravity .....	≈ 4.7 g/cm <sup>3</sup>

*The above quoted properties are typical for Fair-Rite MnZn and NiZn ferrites.*

## Properties of Parylene C\* Coating Material

Dielectric Strength .....	5600	V/mil
Volume Resistivity .....	8.8x10 <sup>16</sup>	ohm
Surface Resistivity .....	10 <sup>14</sup>	ohm
Dielectric Constant (1MHz) .....	2.95	
Dissipation Factor (1MHz) .....	.013	
Density .....	1.29	g/cm <sup>3</sup>
Water Absorption (24 hrs) .....	<.1	%
Coefficient of Friction .....	.29	
Continuous Operating Temperature .....	<100	°C
Thermal Conductivity .....	2.0x10 <sup>-4</sup>	cal/sec/cm/°C
Maximum Operating Temperature .....	<160	°C

\* Union Carbide Trademark

## Conversion Table

SI Units	CGS Units
1 T (tesla) = 1 Vs/m <sup>2</sup>	= 10 <sup>4</sup> gauss
1 mT	= 10 gauss
1 A/m = 10 <sup>-2</sup> A/cm	= .0125 oersted
.1 mT	= 1 gauss
80 A/m	= 1 oersted

## Greek Alphabet

A, α .....	Alpha	N, ν .....	Nu
B, β .....	Beta	Ξ, ξ .....	Xi
Γ, γ .....	Gamma	O, ο .....	Omicron
Δ, δ .....	Delta	Π, π .....	Pi
E, ε .....	Epsilon	Ρ, ρ .....	Rho
Z, ζ .....	Zeta	Σ, σ .....	Sigma
H, η .....	Eta	T, τ .....	Tau
Θ, θ .....	Theta	Υ, υ .....	Upsilon
I, ι .....	Iota	Φ, φ .....	Phi
K, κ .....	Kappa	X, χ .....	Chi
Λ, λ .....	Lambda	Ψ, ψ .....	Psi
M, μ .....	Mu	Ω, ω .....	Omega

# Soft Ferrite References

## IEC Publications on Soft Ferrite Materials and Components

- 60133** (1985) Dimensions of pot-cores made of magnetic oxides and associated parts. (Third Edition).
- 60205** (1966) Calculation of the effective parameters of magnetic piece parts.  
Amendment No. 1 (1976).  
Amendment No. 2 (1981).
- 60205A** (1968) First supplement.
- 60205B** (1974) Second supplement.
- 60220** (1966) Dimensions of tubes, pins, and rods of ferromagnetic oxides.
- 60367:** — Cores for inductors and transformers for telecommunications.
- 60367-1** (1982) Part 1: Measuring methods. (Second Edition).  
Amendment No. 1 (1984).  
Amendment No. 2 (1992).
- 60367-2** (1974) Part 2: Guides for the drafting of performance specifications.  
Amendment No. 1 (1983).
- 60367-2A** (1976) First supplement.
- 60401** (1993) Ferrite materials - Guide on the format of data appearing in manufacturers' catalogues of transformer and inductor cores.
- 60401-1** (1979) Part 1: Classification.
- 60424** (1973) Guide to the specification of limits for physical imperfections of parts made from magnetic oxides.
- 60424-2** (1997) Part 2: RM-Cores.
- 60431** (1983) Dimensions of square cores (RM-cores) made of magnetic oxides and associated parts. (Second edition).  
Amendment No. 1 (1995).  
Amendment No. 2 (1996).
- 60492** (1974) Measuring methods for aerial rods.
- 60525** (1976) Dimensions of toroids made of magnetic oxides or iron powder.  
Amendment No. 1 (1980).
- 60647** (1979) Dimensions for magnetic oxide cores intended for use in power supplies (EC-cores).
- 60701** (1981) Axial lead cores made of magnetic oxides or iron powder.
- 60723:** — Inductor and transformer cores for telecommunications.
- 60723-1** (1982) Part 1: Generic specification.
- 60723-2** (1983) Part 2: Sectional specification: Magnetic oxide cores for inductor applications.  
Amendment No. 1 (1989)
- 60723-2-1** (1983) Part 2: Blank detail specification: Magnetic oxide cores for inductor applications.  
Assessment level A.
- 60723-3** (1985) Part 3: Sectional specification: Magnetic oxide cores for broadband transformers.
- 60723-3-1** (1985) Part 3: Blank detail specification: Magnetic oxide cores for broad-band transformers.  
Assessment levels A and B.
- 60723-4** (1987) Part 4: Sectional specification: Magnetic oxide cores for transformers and chokes for power applications.
- 60723-4-1** (1987) Part 4: Blank detail specification: Magnetic oxide cores for transformers and chokes for power applications. Assessment level A.
- 60723-5** (1993) Part 5: Sectional specification: Adjusters used with magnetic oxide cores for use in adjustable inductors and transformers.
- 60723-5-1** (1993) Part 5: Sectional specification: Adjusters used with magnetic oxide cores for use in adjustable inductors and transformers. Section 1: Blank detail specification. Assessment level A.
- 60732-1** (1982) Measuring methods for cylinder cores, tube cores and screw cores of magnetic oxides.
- 61000-43** (1995) Part 4: Testing and measurement techniques. Section 3: Radiated, radio frequency, electromagnetic fields immunity test.  
Amendment No. 1 (1998).
- 61007** (1994) Transformers and inductors for use in electronic and telecommunication equipment -Measuring methods and test procedures. (Second Edition).
- 61185** (1992) Magnetic oxide cores (ETD-cores) intended for use in power supply applications – Dimensions. Amendment No. 1 (1995).
- 61246** (1994) Magnetic oxide cores (E-cores) of rectangular cross-section and associated parts - Dimensions.
- 61247** (1995) PM-cores made of magnetic oxides and associated parts - Dimensions.



# Soft Ferrite References

- 61332** (1995) Soft ferrite material classification.
- 61596** (1995) Magnetic oxide cores (EP-cores) and associated parts for use in inductors and transformers - Dimensions.
- 61604** (1997) Dimensions of uncoated ring cores of magnetic oxides.

The International Electrotechnical Commission (IEC) is the world organization that prepares and publishes international standards and specifications for all electrical, electronic and related technologies. Founded in 1906, the IEC is presently composed of more than 50 participating countries, including all the world's major trading nations and a growing number of industrializing countries.

The above publications have been issued by IEC Technical Committee No. 51: Magnetic Components and Ferrite Materials. Publications can be purchased from the American National Standards Institute, 11 West 42nd Street, New York, NY, 10036, (212) 642-4990.

## MMPA Publications on Soft Ferrites

- PC 110** Pot Core Standard
- FTC 410** Toroid Standard
- TC 200** Threaded Core Standard
- UEI 310** U, E, and I Core Standard
- SFG-96** Soft Ferrites, a User's Guide

The Soft Ferrite Division of the Magnetic Materials Producers Association was formed in 1973 for the purpose of enhancing communications between ferrite manufacturers and users, increasing the application knowledge of the users, establishing engineering standards, and providing a representative body for the industry.

Soft ferrite MMPA publications can be obtained from Fair-Rite Products Corp. or their representatives.

## Reference Books for Soft Ferrite Applications

*Ferrites for Inductors and Transformers*, 1983  
Snelling, E.C. and Giles, A.D., John Wiley & Sons, New York, NY

*Soft Ferrites, Properties and Applications*, 2nd Edition, 1988  
Snelling, E.C., Butterworths, Stoneham, MA

*Transformer and Inductor Design Handbook*, 1988  
McLyman, Wm. T., Marcel Dekker, New York, NY

*Transmission Line Transformers*, 1990  
Sevick, J., American Radio Relay League, Newington, CT

*Soft Magnetic Materials*, 1979  
Boll, R., John Wiley & Sons, New York, NY

*Transformers for Electronic Circuits*, 2nd Edition, 1990  
Grossner, N., McGraw Hill, New York, NY

*Modern Ferrite Technology*, Second Edition, 1999  
Goldman, A., Kluwer Academic Publishers, Boston/  
Dordrecht, Netherlands/London

# Glossary of Terms

## **Air Core Inductance - $L_o$ (henry)**

The inductance that would be measured if the core had unity permeability and the flux distribution remained unaltered.

## **Coercive Force - $H_c$ (oersted or A/m)**

The magnetizing field strength required to bring the magnetic flux density of the magnetized material to zero.

## **Core Constant - $C_1$ (cm<sup>-1</sup>)**

The summation of the magnetic path lengths of each section of a magnetic circuit divided by the corresponding magnetic area of the same section.

## **Core Constant - $C_2$ (cm<sup>-3</sup>)**

The summation of the magnetic path lengths of each section of a magnetic circuit divided by the square of the corresponding magnetic area of the same section.

## **Curie Temperature - $T_c$ (°C)**

The transition temperature above which a ferrite loses its ferromagnetic properties.

## **Disaccommodation - $D$**

The proportional decrease of permeability after a disturbance of magnetic material, measured at constant temperature, over a given time interval.

## **Disaccommodation Factor - $DF$**

The disaccommodation factor if the disaccommodation after magnetic conditioning divided by the permeability of the first measurement times  $\log_{10}$  of the ratio of time intervals.

## **Effective Dimensions of a Magnetic Circuit -**

Area  $A_e$  (cm<sup>2</sup>), Path Length  $l_e$  (cm) and Volume  $V_e$  (cm<sup>3</sup>)

For a magnetic core of given geometry, the magnetic path length, the cross-sectional area and the volume that a hypothetical toroidal core of the same material properties should possess to be the magnetic equivalent to the given core.

## **Field Strength - $H$ (oersted or A/m)**

The parameter characterizing the amplitude of the alternating field strength.

## **Flux Density - $B$ (gauss or mT)**

The corresponding parameter for the induced magnetic field in an area perpendicular to the flux path.

## **Flux Density, saturation - $B_s$ (gauss or mT)**

The maximum intrinsic induction possible in a material.

## **Inductance Factor - $A_L$ (nH)**

Inductance of a coil on a specified core divided by the square of the number of turns. (Unless otherwise specified the inductance test conditions for the inductance factor are at flux density <10 gauss).

## **Loss Factor - $\tan \delta/\mu_i$**

The phase of displacement between the fundamental components of the flux density and the field strength divided by the initial permeability.

## **Magnetic Constant - $\mu_o$**

The permeability of free space.

## **Magnetic Hysteresis**

In the magnetic material, the irreversible variation of the flux density or the magnetization which is associated with the change of magnetic field strength and is independent of the rate change.

## **Magnetically Soft Material**

A magnetic material with low coercivity.

## **Permeability, amplitude - $\mu_a$**

The quotient of the peak value of the flux density and the peak value of the applied field strength at a stated amplitude of either, with no static present.

## **Permeability, complex series - $\mu_s', \mu_s''$**

The real and imaginary components respectively of the complex permeability expressed in series terms.

## **Permeability, effective - $\mu_e$**

For a magnetic circuit constructed with an air gap or air gaps, the permeability of a hypothetical homogeneous material which would provide the same reluctance.

## **Permeability, incremental - $\mu_\Delta$**

Under stated conditions the permeability obtained from the ratio of the flux density and the applied field strength of an alternating field and a superimposed static field.

## **Permeability, initial - $\mu_i$**

The permeability obtained from the ratio of the flux density, kept at <10 gauss, and the required applied field strength. Material initially in a specified neutralized state.

## **Power Loss Density - $P$ (mW/cm<sup>3</sup>)**

The power absorbed by a body of ferrimagnetic material and dissipated as heat, when the body is subject to an alternating field which results in a measurable temperature rise. The total loss is divided by the volume of the body.

## **Remanence - $B_r$ (gauss or mT)**

The flux density remaining in a magnetic material when the applied magnetic field strength is reduced to zero.

## **Temperature Coefficient - $TC$**

The relative change of the quantity considered, divided by the difference in the temperatures producing it.

## **Temperature Factor - $TF$**

The fractional change in the initial permeability over temperature range, divided by the initial permeability.

# Magnetic Design Formulas

## Effective Core Parameters

$$C_1 = \Sigma l/A \quad (\text{cm}^{-1}) \quad C_2 = \Sigma l/A^2 \quad (\text{cm}^{-3})$$

$$l_e = C_1^2/C_2 \quad (\text{cm}), \quad A_e = C_1/C_2 \quad (\text{cm}^2)$$

Magnetic path is divided into elements with length  $l$  and cross-sectional area  $A$ .

$$V_e = C_1^3/C_2^2 \quad (\text{cm}^3)$$

## Flux Density Peak

$$\hat{B} = \frac{E 10^8}{4.44 f N A_e} \quad (\text{gauss})$$

## Field Strength (Peak)

$$\hat{H} = \frac{.4 \pi N I_p}{l_e} \quad (\text{oersted})$$

Where  $E$  = RMS sine wave voltage (V)  
 $f$  = Frequency (Hz)  
 $A_e$  = Effective cross-sectional area (cm<sup>2</sup>)  
 $l_e$  = Effective path length (cm)  
 $I_p$  = Peak current (A)  
 $N$  = Number of turns

\* To check for maximum peak flux density in a non-uniform core set substitute  $A_{\min}$  for  $A_e$ .

## Air Core Inductance

$$L_o = \frac{4 \pi N^2 10^{-9}}{C_1} \quad (\text{H})$$

$C_1$  in cm<sup>-1</sup>

## Number of Turns

$$N = \sqrt{\frac{L 10^9}{A_L}} \quad L \text{ in H}$$

## Inductance

$$L = N^2 A_L \quad (\text{nH})$$

$$L = \mu_1 \frac{4 \pi N^2}{C_1} 10^{-9} \quad (\text{H})$$

$$L = \mu_e \frac{4 \pi N^2}{C_1} 10^{-9} \quad (\text{H}) \quad \left. \vphantom{L} \right\} C_1 \text{ in cm}^{-1}$$

## Effective Permeability

$$\mu_e = \frac{l_e}{l_e/\mu_1 + l}$$

Where  $l_e$  = Effective path length  
 $l$  = Air gap length

## Attenuation

$$A = 20 \log_{10} \frac{|Z_s + Z_L + Z_{sc}|}{|Z_s + Z_L|} \quad (\text{dB})$$

Where  $Z_s$  = Source impedance  
 $Z_L$  = Load impedance  
 $Z_{sc}$  = Suppression core impedance

## Quality Factor

$$Q = \frac{2 \pi f L_s}{R_s} = \frac{R_p}{2 \pi f L_p}$$

# Wire Table of Copper Magnet Wire

AWG & B&S Gauge	Diameter (Inch)	Cross-Sectional Area		Feet per Ohm (20°C)	Ohms per 1000 ft (20°C)	Amperes for 1mA/cir mil	Turns per Inch <sup>2</sup>
		(Inch <sup>2</sup> )	(cir mils)				
10	.1019	.00815	10380	1001	1.00	10.4	92
11	.0907	.00647	8234	794	1.26	8.25	118
12	.0808	.00513	6530	630	1.59	6.54	146
13	.0719	.00407	5178	499	2.00	5.18	180
14	.0641	.00322	4107	396	2.53	4.11	231
15	.0571	.00256	3257	314	3.18	3.26	275
16	.0508	.00203	2583	249	4.02	2.59	346
17	.0453	.00161	2048	198	5.06	2.05	432
18	.0403	.00127	1624	157	6.39	1.62	544
19	.0359	.00101	1288	124	8.05	1.29	679
20	.0320	.000804	1022	98.5	10.2	1.03	854
21	.0285	.000638	810.1	78.1	12.8	.81	1065
22	.0254	.000505	642.4	62.0	16.1	.64	1345
23	.0226	.000400	509.5	49.1	20.4	.51	1675
24	.0201	.000317	404.0	39.0	25.7	.40	2095
25	.0179	.000252	320.4	30.9	32.4	.321	2630
26	.0159	.000200	254.1	24.5	40.8	.255	3325
27	.0142	.000158	201.5	19.4	51.4	.201	4110
28	.0126	.000126	159.8	15.4	64.9	.160	5210
29	.0113	.000100	126.7	12.2	81.9	.128	6385
30	.0100	.0000785	100.5	9.7	103.1	.100	8145
31	.0089	.0000622	79.7	7.7	130.1	.079	10,097
32	.0080	.0000503	63.2	6.1	163	.064	12,270
33	.0071	.0000396	50.1	4.8	206	.050	15,615
34	.0063	.0000312	39.8	3.83	261	.040	19,655
35	.0056	.0000248	31.5	3.04	330	.0316	25,530
36	.0050	.0000196	25.0	2.41	415	.0250	31,405
37	.0045	.0000159	19.8	1.91	524	.0203	39,570
38	.0040	.0000126	15.7	1.52	670	.0160	49,070
39	.0035	.00000962	12.5	1.20	832	.0122	65,790
40	.0031	.00000755	9.89	0.953	1049	.0098	82,180
41	.0028	.00000616	7.84	0.756	1323	.0079	98,860
42	.0025	.00000491	6.20	0.598	1672	.0062	121,175
43	.0022	.00000380	4.93	0.476	2101	.0048	158,245
44	.0020	.00000314	3.88	0.374	2674	.0039	205,515
45	.0018	.00000254	3.10	0.299	3344	.0032	249,855
46	.0016	.00000201	2.46	0.238	4202	.0025	310,205

**Fair-Rite Products Corp.** P.O. Box J, One Commercial Row, Wallkill, NY 12589-0288

Phone: (888) FAIR RITE / (845) 895-2055 • FAX: (888) FERRITE / (845) 895-2629 • www.fair-rite.com • E-Mail: ferrites@fair-rite.com  
(888) 324-7748 (888) 337-7483 **Note: (914) Area Code has changed to (845).**

# Technical Information

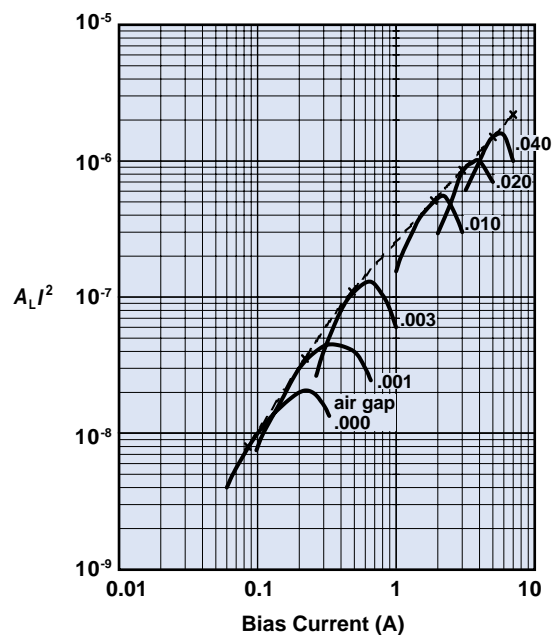
## The Effect of Direct Current on the Inductance of a Ferrite Core

### Introduction

If ferrite cores are used in the design of transformers, chokes or filters, which are required to carry direct current, it is necessary to predict the degree of inductance degradation caused by the static field. When dc flows through the winding of a ferromagnetic device, it tends to pre-magnetize the core and reduce its inductance. The permeability of a ferrite material measured with superimposed dc might increase slightly for very low values of dc ampere-turns, but then it progressively decreases as the dc field is increased and the core approaches saturation. This permeability is referred to as the incremental permeability  $\mu_{\Delta}$ . If an air gap is introduced into the magnetic path of a core, the reluctance is increased hence the inductance is decreased. However, the core's capacity for dc ampere-turns without a degradation in inductance is significantly improved, albeit at the expense of a lower effective permeability.

### DC Bias in Gapped Cores

The use of graphs such as the Hanna\* curves has simplified the tedious trial and error methods often employed when designing inductors with superimposed dc. A Hanna curve is created by measuring the inductance vs. dc bias of various core sizes and gap lengths of the same material grade. The measured data is used to create curves such as those plotted in Figure 1 (this curve is specific for a set of 9478015002 E cores). A line is drawn connecting the individual curves through the point of tangency. The graphs are then normalized by dividing the vertical scale of Figure 1 by the effective core volume  $V_e$  and the horizontal scale by the effective path length  $l_e$  of the core set. The individual curves, once normalized, overlay creating the Hanna curve. Figure 2 is such a curve for Fair-Rite 78 material and can be used for all core sets in that material.



**Figure 1** Product inductance factor and current squared vs. DC current for a pair of 9478015002 E cores.

### Design Example

For a typical output choke application, the designer knows a number of design criteria such as the required inductance, the direct current, alternating ripple current and allowable dc resistance. He will also have requirements for core size, ambient temperature and often a preference for a particular core geometry.

\*Footnote: C.R. Hanna presented a paper "Design of Reactances and Transformers which Carry Direct Current" at the 1927 Winter Convention of AIEE. The paper provided a method of calculating the air gap that will yield the maximum inductance for a given number of turns, with a specified amount of dc, for a particular material.

# Technical Information

The following example illustrates the use of the Hanna curve in the design of an inductor.

Inductor specifications:

Minimum inductance	$L = 1 \text{ mH}$
Direct current	$I_{dc} = 1 \text{ A}$
Alternating ripple current	$I_{ac} = 0.2 \text{ A}$
Maximum dc resistance	$R_{dc} < 0.2 \Omega$

**Step 1. Initial Core Selection.**

Using the Hanna curve for 78 material of Figure 2, select a value for  $L^2 / V_e$  approximately mid range on the vertical axis, that is between  $10^{-4}$  and  $10^{-3}$ . Any value greater than  $10^{-3}$  will work the ferrite too hard and the dc resistance is apt to be high. Anything lower than  $10^{-4}$  will result in a conservative design and the dc resistance will be quite low.

Select therefore  $L^2 / V_e = 3.5 \cdot 10^{-4}$

Calculate  $V_e$  from:

$$V_e = L^2 / 3.5 \cdot 10^{-4}$$

$$L_{min} = 1 \text{ mH, design for } L = 1.1 \cdot 10^{-3} \text{ H}$$

$$I = I_{dc} + I_{ac} / 2 = 1 + 0.2 / 2 = 1.1 \text{ A}$$

$$V_e = 1.1 \cdot 10^{-3} \times 1.1^2 / 3.5 \cdot 10^{-4} = 3.8 \text{ cm}^3$$

Select E core (preferred core shape), based upon the calculated core volume of  $3.8 \text{ cm}^3$  from the catalog, pages xx and xx. Two Fair-Rite E cores are considered:

9478015002	$V_e = 1.95 \text{ cm}^3$ and
9478014002	$V_e = 3.92 \text{ cm}^3$ .

The 9478014002 is closest and will be used in this inductor design. The core parameters for this E core set are:

$$l_e = 4.9 \text{ cm, } A_e = .80 \text{ cm}^2 \text{ and } V_e = 3.92 \text{ cm}^3.$$

Recalculate

$$L^2 / V_e = 1.1 \cdot 10^{-3} \times 1.1^2 / 3.92 = 3.4 \cdot 10^{-4}.$$

**Step 2. Number of Turns, Wire Size and Wire Fit.**

From Figure 2, a  $L^2 / V_e = 3.4 \cdot 10^{-4}$  yields a H value of 17 oersted.

Calculate turns  $N$  from the formula  $H = .4 \pi NI / l_e$  oersted.

$$N = 17 \times 4.9 / (.4 \times \pi \times 1.1) = 60.3 \text{ or } 61 \text{ turns.}$$

From the core dimensions, the core winding area can be calculated, see Table 1.

Winding area for a set of E cores 9478014002 is:

$$A_w = D(E-F) \text{ in inch}^2.$$

$$A_w = .255 (.740 - .250) = .125 \text{ inch}^2.$$

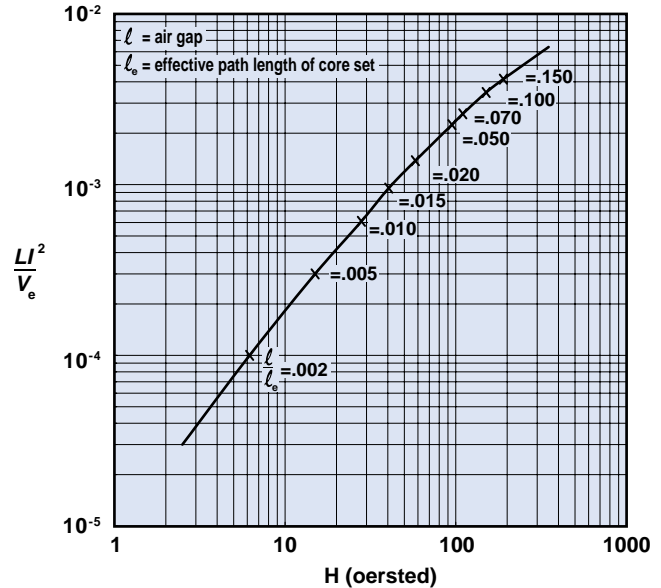


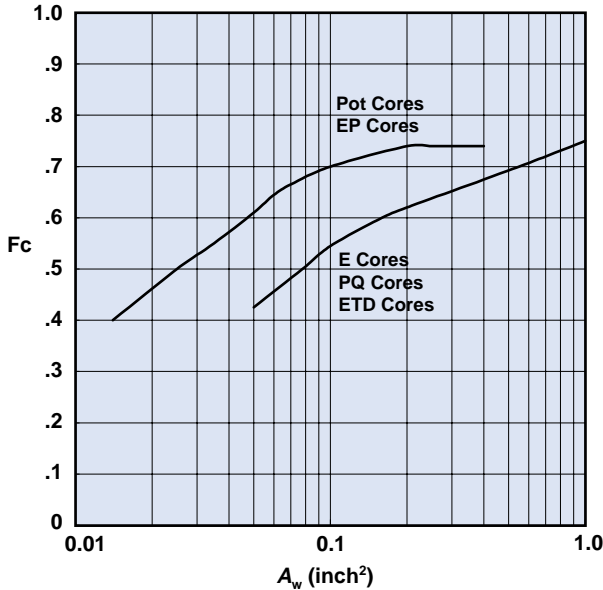
Figure 2 Hanna curve for core sets in 78 material.

E Cores	D(E-F)
ETD Cores	D(E-F)
PQ Cores	D(E-F)
Pot Cores	D(E-F)
EP Cores	D(E-F)

Since the winding area of the appropriate bobbin is smaller than the core winding area, a correction factor  $F_c$  has to be used to determine the bobbin winding area. Figure 3 gives this correction factor  $F_c$  as a function of the calculated core winding area  $A_w$ . A set of E cores 9478014002 has a  $A_w = .125 \text{ inch}^2$ , from Figure 3 can be determined that the  $F_c = .55$ , therefore the bobbin winding area is  $.55 \times .125 = .069 \text{ inch}^2$ . Using a conservative current density of 1 mA per circular mil or 1275 A per inch<sup>2</sup>, an initial wire size selection of 20 AWG can be made from the Wire Table on page xx. To determine the dc resistance of the winding, first find the average length of turn from Table 2.

E Cores	2 (C+E)
ETD Cores	.5 $\pi$ (E+F)
PQ Cores	.5 $\pi$ (E+F)
Pot Cores	.5 $\pi$ (E+F)
EP Cores	.5 $\pi$ (E+F)

# Technical Information



**Figure 3** Correction factor  $F_c$  vs. core winding area  $A_w$ .

Average length of turn for E 9478014002 is:

$$l_{avg.} = 2 (C+F)$$

$$l_{avg.} = 2 (.500 + .740) = 2.48 \text{ inch.}$$

$$R_{dc} = 2.48 \times 61 \times 10.2/12000 = 0.13 \Omega$$

(From the Wire Table, 1000 ft of 20 AWG has a resistance of 10.2  $\Omega$ )

To check for winding fit, multiply the number of turns per square inch for 20 AWG from the Wire Table with the bobbin winding area of .069 inch<sup>2</sup>. For 20 AWG, the bobbin winding area can accommodate 854 x .069 = 58.9 turns. This is too close to the calculated turns for an easily manufactured magnetic design. Use 21 AWG wire instead.

$$R_{dc} = 2.48 \times 61 \times 12.8/12000 = 0.16 \Omega.$$

Winding fit for 21 AWG:

$$N = 1065 \times .069 = 73.5, \text{ well above the require 61 turns.}$$

**Step 3. Air gap.**

Going back to Figure 2, for  $LP^2 / V_e = 3.4 \times 10^{-4}$  and a  $H = 17$  oersted, a  $l/l_e$  ratio of approximately .006 is found.

$$\text{The gap length} = .006 \times l_e$$

$$l = .006 \times 4.9/2.54 = .012 \text{ inch.}$$

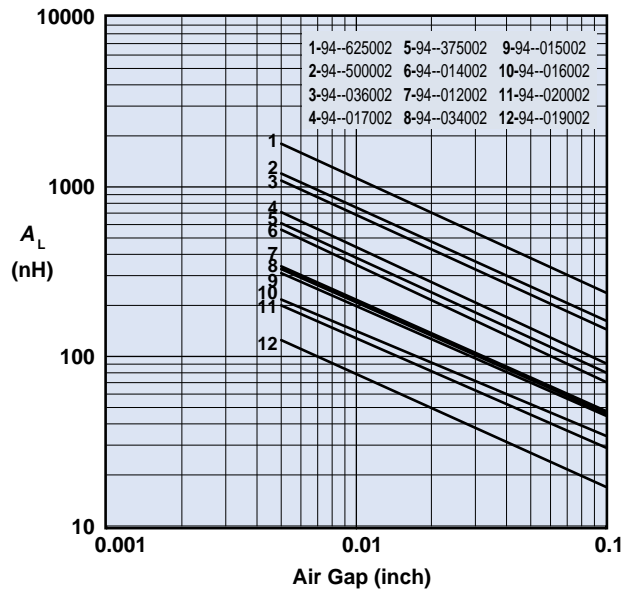
To summarize:

- E core 9478014002                      N = 61 turns
- Wire size 21 AWG                        Gap length .012 inch

The graphs in Figures 4 through 8 show the inductance factors or  $A_L$  values as a function of the air gaps for the different core types and sizes. The air gap determined in the design example and the air gaps shown in Figures 4 through 8 represent the total air gap. The most practical way to obtain this air gap is to grind this gap into the center leg of one of the core halves. Non-metallic shims can also be used to obtain the desired air gap. This is usually done by placing shims between the outer legs or outside rims of the core halves. In cores with a uniform cross-sectional area, the  $A_L$  value or inductance index will be the same whether the core is gapped or shims are used that have a thickness half the total air gap. For cores that have a non-uniform cross-sectional area the shim thickness can be calculated from:

$$\text{Shim thickness} = \text{total air gap} \times \frac{\text{center mating area}}{\text{total mating area}}$$

The above example of the E core 9478014002, a core with a uniform cross-sectional area, can therefore use .006 inch shims between the outer legs.



**Figure 4**  $A_L$  vs. gap for E cores in 77 and 78 material.

# Technical Information

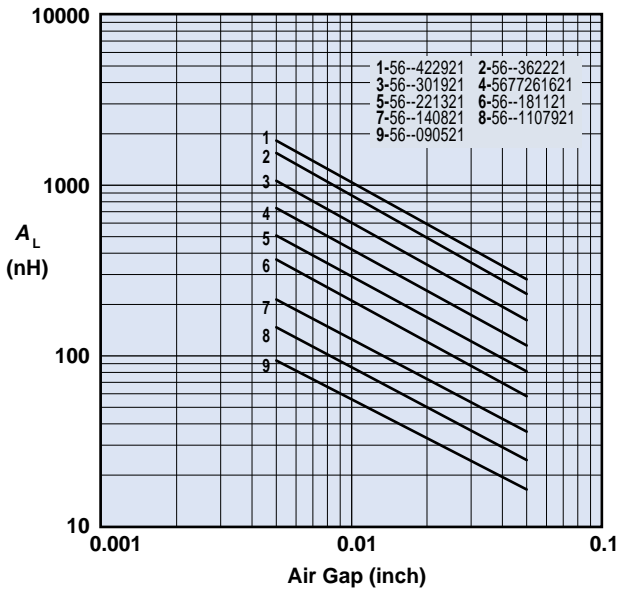


Figure 5  $A_L$  vs. gap for pot cores in 77 and 78 material.

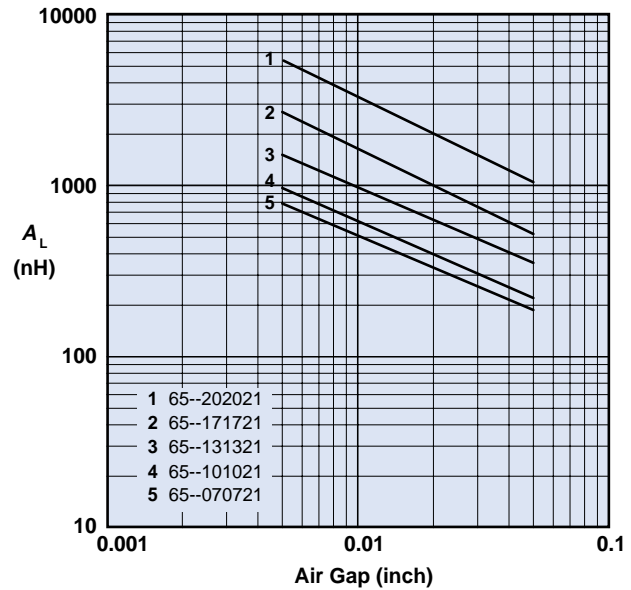


Figure 6  $A_L$  vs. gap for EP cores in 77 and 78 material.

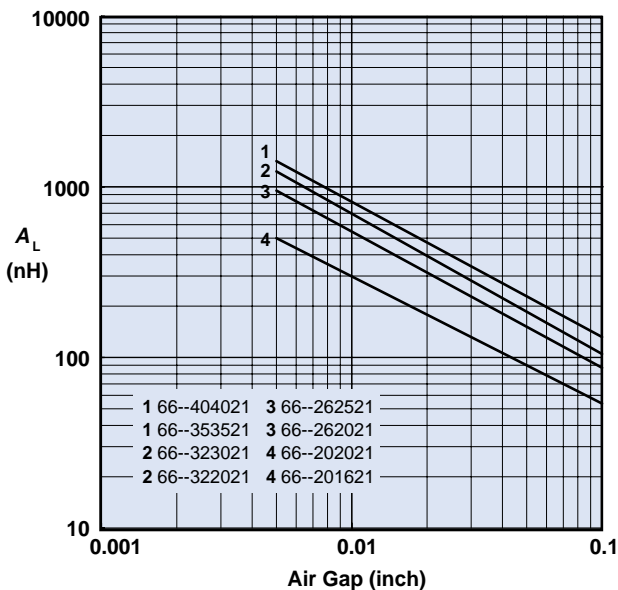


Figure 7  $A_L$  vs. gap for PQ cores in 77 and 78 material.

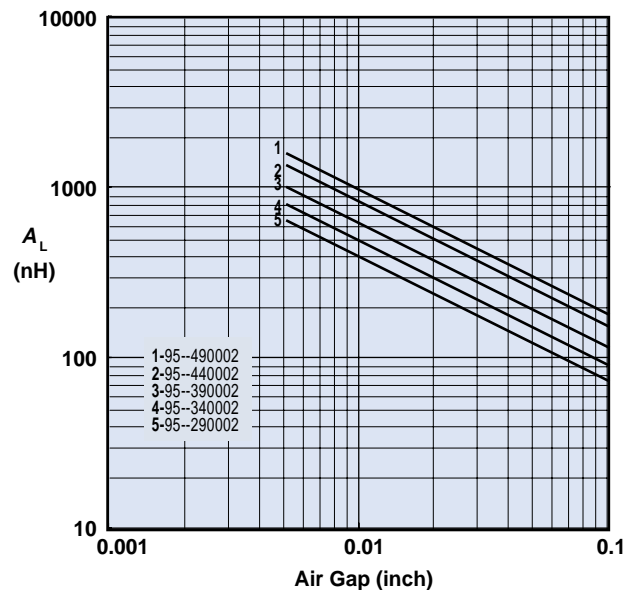


Figure 8  $A_L$  vs. gap for ETD cores in 77 and 78 material.



# Technical Information

## DC Bias in Open Magnetic Cores

The discussion so far has been on core types that have a closed magnetic path, in which a small air gap has been inserted by either a ground gap or the use of shims. An open magnetic core can be thought of as a core with a very large fixed air gap. Since the air gap is determined by the core geometry and cannot be changed, the Hanna curves can not be used for these types of cores. Such cores as rods, slugs and bobbins can be used quite successfully in inductor designs that have relative low inductance values and can accommodate significant amounts of static currents.

The large air gap will forestall the saturation of this type of core, hence the inductance will not as rapidly decrease as a function of the dc ampere-turns. The Fair-Rite bobbins, listed on the pages 134 and 135 of the catalog, are specified to an inductance factor or  $A_L$  with a tolerance of  $\pm 10\%$  and also by a  $NI$  product of dc ampere-turns, which would reduce the  $A_L$  value but not more than 5%. For an inductor design the number of turns can

be calculated from the required inductance  $L$  and the inductance factor of the bobbin.  $N = L/A_L$ , ( $L$  in nH). The turns  $N$  times the direct current  $I$  will give the  $NI$  product, which should be less than the value quoted for the bobbin. For winding fit and dc resistance check, the same procedure is used as outlined in the example above, except here the  $A_w$  of the bobbin is the total available winding area. The graphs of Figure 9 show the effect of temperature on the inductance factor vs. dc bias characteristics of the 9677242409 bobbin. As can be seen from these curves, the decrease in inductance increases with temperature. The  $NI$  values listed in the catalog are at room temperature, and must be derated when operating at elevated temperatures. Open magnetic cores, rods, slugs and bobbins are used and designed into SCR and triac controls, speaker crossover networks and differential-mode input filters. They are also utilized for EMI suppression applications where relative large direct currents are present and for output chokes in switched-mode power supplies.

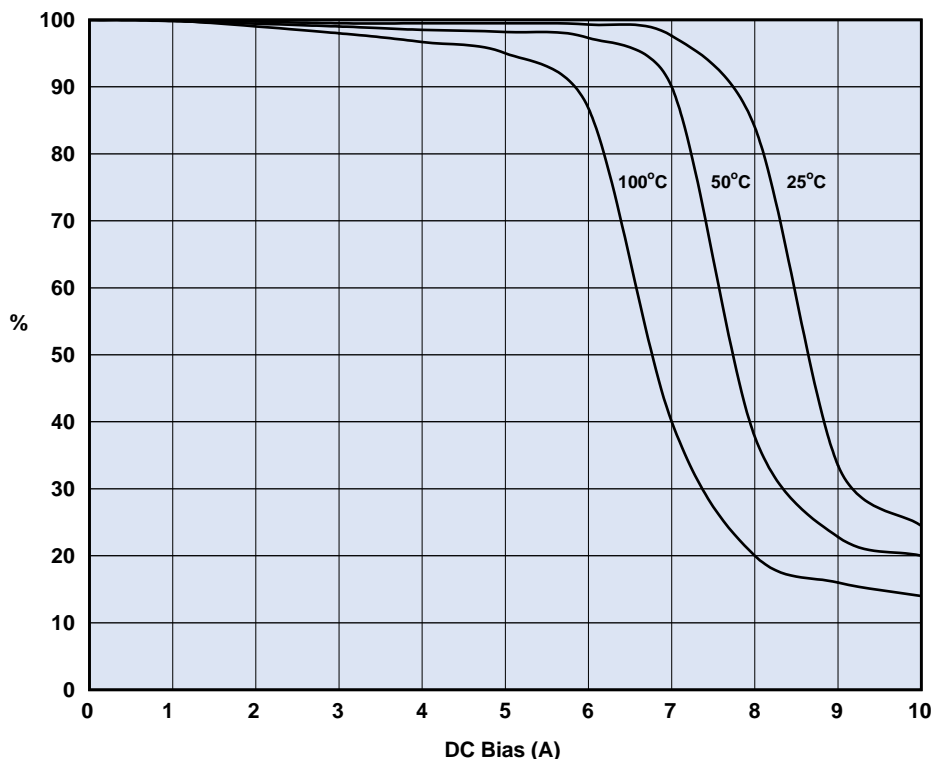


Figure 9 Percent of original inductance factor vs. DC bias and temperature.

# Technical Information

## Use of Ferrites in Broadband Transformers

### Introduction

Most of the magnetic information in this catalog is data obtained from cores wound with a single multi-turn-winding which forms an inductor. When a second winding is added on the core, the inductor becomes a transformer. Depending on the requirements, transformers can be designed to provide dc isolation, impedance matching and specific current or voltage ratios. Transformer designed for power, broadband, pulse, or impedance matching can often be used over a broad frequency spectrum.

In many transformer designs ferrites are used as the core material. This article will address the properties of the ferrite materials and core geometries which are of concern in the design of low power broadband transformers.

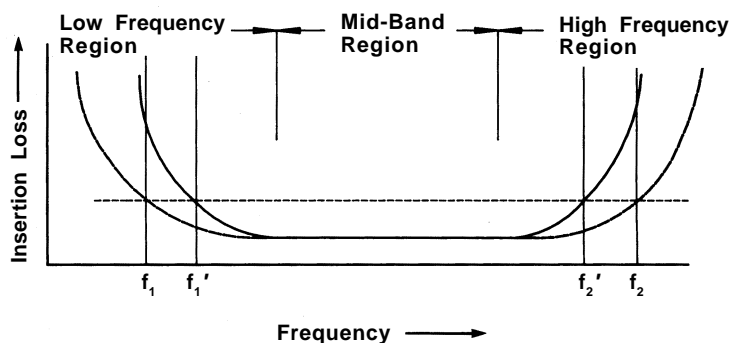
### Brief Theory

Broadband transformers are wound magnetic devices that are designed to transfer energy over a wide frequency range. Most applications for broadband transformers are in telecommunication equipment where they are extensively used at a low power levels.

Figure 1 shows a typical performance curve of insertion loss as a function of frequency for a broadband transformer. The bandwidth of a broadband transformer is the frequency difference between  $f_2$  and  $f_1$ , or between  $f_2'$  and  $f_1'$ , and is a function of the specified insertion loss and the transformer roll-off characteristics.

It can be seen that the bandwidth is narrower for transformers with a steep roll-off ( $f_2' - f_1'$ ) than those with a more gradual roll-off ( $f_2 - f_1$ ). Also in Figure 1, the three frequency regions are identified.

The cutoff frequencies are determined by the requirements of the individual broadband transformer design. Therefore,  $f_1$  can be greater than 10 MHz or less than 300 Hz. Bandwidths also can vary from a few hundred hertz to hundreds of MHz. A typical

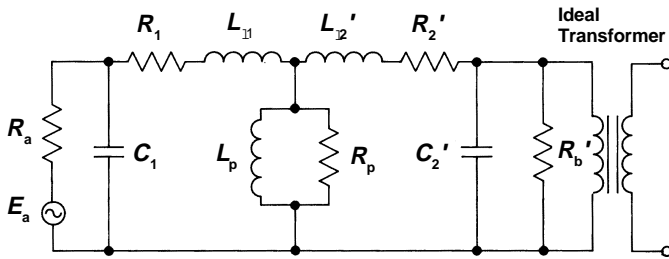


**Figure 1** Typical Characteristic Curve of Insertion Loss vs. Frequency for a broadband transformer.

broadband transformer design will specify for the mid frequency range a maximum insertion loss and for the cutoff frequencies,  $f_1$  and  $f_2$  maximum allowable losses. Figure 2 is a schematic diagram of the lumped element equivalent circuit of a transformer, separating the circuit into an ideal transformer, its components and equivalent parasitic resistances and reactances. The secondary components, parasitics and the load resistance have been transferred to the primary side and are identified with a prime.

To simplify this circuit, the primary and secondary circuit elements have been combined and the equivalent reduced circuit is shown in Figure 3. The physical significance of the parameters are listed below the equivalent circuits. In the low frequency region the roll-off in transmission characteristics is due a lowering of the shunt impedance. The shunt impedance decreases when the frequency is reduced, which results in the increases level of attenuation. The impedance is mainly a function of the

# Technical Information



**Figure 2** Lumped equivalent of a transformer.

- $E_a$  = source EMF
- $R_a$  = source resistance
- $C_1$  = primary winding capacitance
- $R_1$  = resistance of primary winding
- $L_{11}$  = primary leakage inductance
- $L_p$  = open circuit inductance of primary winding
- $R_p$  = shunt resistance that represents loss in core
- Secondary parameters reflected to the primary side.
- $C_2'$  = secondary winding capacitance
- $R_2'$  = resistance of secondary winding
- $L_{12}'$  = secondary leakage inductance
- $R_b'$  = load resistance

primary reactance  $X_{Lp}$  with a negligible contribution of the equivalent shunt loss resistance  $R_p$ . The insertion loss may therefore be expressed in terms of the shunt inductance:

$$A_i = 10 \log_{10} \left( 1 + \left( \frac{R}{\omega L_p} \right)^2 \right) \text{ dB}$$

Where  $R = R_a \times R_b' / R_a = R_b'$

For most ferrite broadband transformer designs, the only elements that are likely to effect the transmission at the mid-band frequency range are the winding resistances. The insertion loss for the mid-band frequency region due to the winding resistance may be expressed as:

$$A_i = 20 \log_{10} \left( 1 + \frac{R_c}{R_a + R_b'} \right) \text{ dB}$$

Where  $R_c = R_1 + R_2'$

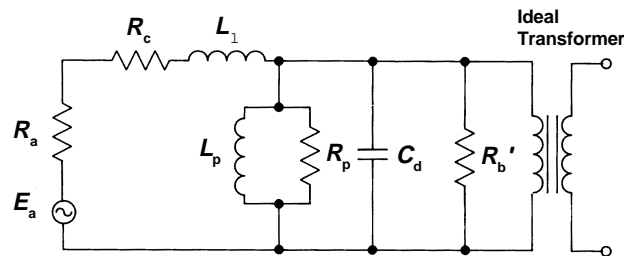
In the higher frequency region the transmission characteristics are mainly a function of the leakage inductance or the shunt capacitance. It is often necessary to consider the effect of both of these reactances, depending upon the circuit impedance. In a low impedance circuit the high frequency droop due to leakage inductance is:

$$A_i = 10 \log_{10} \left( 1 + \left( \frac{\omega L_1}{R_a + R_b'} \right)^2 \right) \text{ dB}$$

This high frequency droop in a high impedance circuit, due to the shunt capacitance, is as follows:

$$A_i = 10 \log_{10} \left( 1 + (\omega CR)^2 \right) \text{ dB}$$

Reviewing the insertion loss characteristics for the three frequency regions, it can be concluded that the selection of ferrite material and core shape should result in a transformer design that yields the highest inductance per turn at the low frequency cutoff  $f_1$ . This will result in the required shunt inductance for the low frequency region with the least number of turns. The low number of turns are desirable for low insertion loss at the mid-band region and also for low winding parasitics needed for good response at the high frequency cutoff  $f_2$ .



**Figure 3** Simplified equivalent transformer circuit

- $C_d = C_1 + C_2'$
- $R_c = R_1 + R_2'$
- $L_1 = L_{11} + L_{12}'$

For other circuit parameters see Figure 2.

# Technical Information

## Low and Medium Frequency Broadband Transformers

For broadband transformer applications the optimum ferrite is the material that has the highest initial permeability at the lower cutoff frequency  $f_1$ . Manganese zinc ferrites, such as Fair-Rite 77 or 78 material, are very suitable for low and medium frequency broadband transformers designs. As stated before, the transformer parameter that is most critical is the shunt reactance ( $\omega L$ ), which will increase with frequency as long as the material permeability is constant or diminishing at a rate less than the increase in frequency. This holds true even if a transformer is designed using a manganese zinc ferrite where  $f_1$  is at the higher end of the flat portion of the permeability vs. frequency curve. Although the whole bandpass lies in the area where the initial permeability is decreasing, yet the bandpass characteristics will be virtually unaffected. For broadband transformers that use a manganese zinc ferrite material the core geometry should be such as to minimize the  $R_{dc}/L$  ratio. In other words, the ratio of dc resistance to the inductance for a single turn should be a minimum. The range of pot cores, standardized by the International Electrotechnical Commission in document IEC 60133, has been designed for this minimum  $R_{dc}/L$  ratio.\* Other core shapes such as the EP cores and PQ cores can also be used in the design of these broadband transformers. Often the final core selection will also be influenced by such considerations as ease of winding, terminating and other mechanical design constraints of the transformer.

## Broadband Transformers with a Superimposed Static Field

In transformer designs that have a superimposed direct current, gapped cores can be employed to overcome the decrease in the shunt inductance. Hanna curves can be used to aid in the design of inductive devices that carry a direct current. For more information see section "The Effect of Direct Current on the Inductance of a Ferrite Core" on page 165.

## High Frequency Broadband Transformers.

Although there is no clear division between the frequency regions, for this article it is assumed that the high frequency broadband transformer designs use nickel zinc ferrites as the preferred core material. This will typically occur for transformer

designs where the bandpass lies wholly above 500 kHz. At these higher operating frequencies it becomes more important to consider the complex magnetic parameters of the core material, rather than use the simple core constants, such as  $A_L$ , recommended for low frequency designs.

Another important consideration is that high frequency transformers are generally used in low impedance circuits, which means that these designs require low shunt impedances. This can often be accomplished with a few turns, hence winding resistances are no longer an issue, and the design concept of minimizing  $R_{dc}/L$  is no longer required. The design will instead become focused on core shape and material for the required shunt impedance at  $f_1$ , along with reducing leakage inductance of the winding. Since the material characteristics permeability and losses affect the shunt impedance these parameters need to be considered in high frequency broadband transformer designs. Figures 4, 5 and 6 are typical curves of impedance  $Z$ , equivalent parallel reactance  $X_p$  and equivalent parallel loss resistance  $R_p$  as a function of frequency. They are measured on the same multi-aperture core 28—002302, in 73, 43, and 61 material, wound with a single turn through both holes. For high frequency broadband transformers the toroidal core shape becomes an attractive core geometry. The few turns that are often required can easily be wound on the toroid. However, windings that require only a few turns may give rise to problems in obtaining the desired impedance ratios. To minimize leakage inductance it is suggested that the primary and secondary windings be tightly coupled and where possible a bifilar winding be used.

An improvement in core performance over toroids can be obtained by the use of multi-aperture cores, which can be considered as two toroidal cores side by side. This core shape has a lower single turn winding length than the equivalent toroidal core with the same core constant  $C_1$ , and will result in a wider bandwidth of the transformer design. Many broadband transformers have been designed utilizing nickel zinc ferrite toroids with good results. If bandwidth requirements cannot be met using toroids, multi-aperture nickel zinc cores should be considered.

The multi-aperture cores listed in this catalog on page 84, are available in the nickel zinc ferrite materials 61 and 43 as well in the manganese zinc ferrite 73 material.

# Technical Information

## Summary

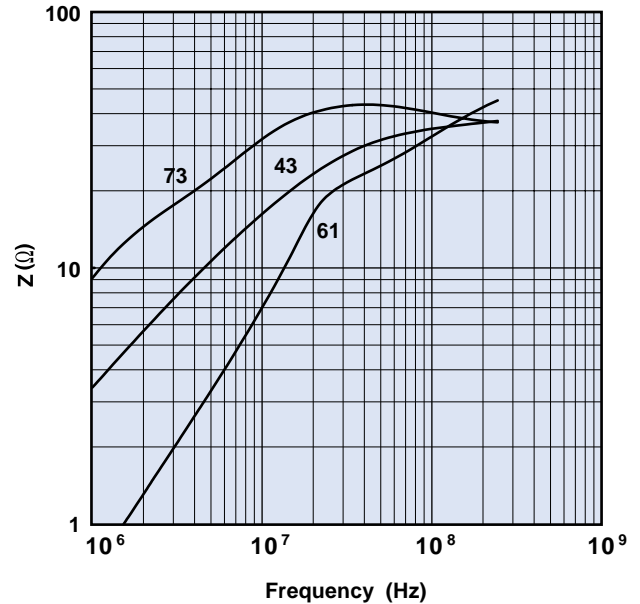
The low cutoff frequency  $f_1$  is the single most important factor in the ferrite material selection. The material with the highest initial permeability at  $f_1$  is the recommended choice.

Manganese zinc ferrites, 77 and 78, can be used to a cutoff frequency  $f_1$  of 500 kHz. Above this frequency use a nickel zinc ferrite, again depending upon the frequency  $f_1$ , select 61 or 43 material.

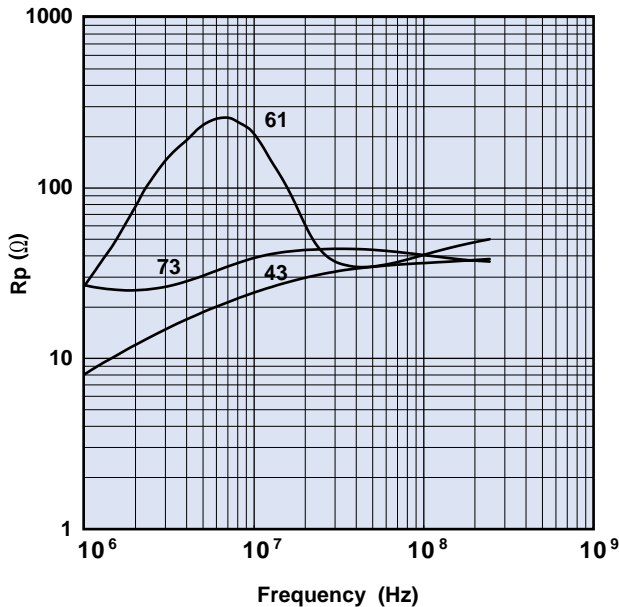
For low and medium frequency transformers the optimum core shape should provide the lowest DC resistance per unit of inductance. If there is a superimposed dc present the use of gapped cores and Hanna curves is suggested. For high frequency designs, use nickel zinc ferrite. The toroidal and multi-aperture cores are the recommended core configurations.

The number of turns should be kept to a minimum to reduce leakage inductance and self-capacitance of the windings. Wind primary and secondary windings tightly coupled or as bifilar windings to lower leakage inductance.

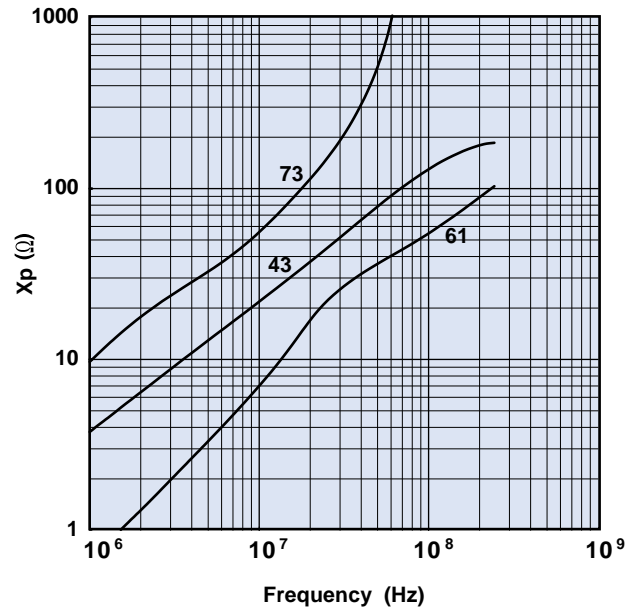
The Bead, Balun and Broadband Kit II, part number 0199000011, contains a variety of components suited for broadband transformer design evaluations, see page 92.



**Figure 4** Impedance vs. frequency for part number 28—002302 in 73, 43 and 61 material.



**Figure 5** Parallel resistance vs. frequency for part number 28—002302 in 73, 43 and 61 material.



**Figure 6** Parallel reactance vs. frequency for part number 28—002302 in 73, 43 and 61 material.

# Technical Information

## How to Choose Ferrite Components for EMI Suppression

### Introduction

The following pages will focus on Soft Ferrites used in the application of electromagnetic interference (EMI) suppression. Although the end use is an important issue and some applications are mentioned, this technical section is not intended to be a design manual, but rather, an aid to the designer in understanding and choosing the optimum ferrite material and component for their particular application. Ferrite suppressor cores are simple to use, in either initial designs or retrofits, and are comparatively economical in both price and space. Ferrite suppressors have been successfully employed for attenuating EMI in computers and related products, switching power supplies, electronic automotive ignition systems, and garage doors openers, to name just a few.

### Use of Ferrite Suppressor Cores

The United States was one of the first countries to recognize the potential problems caused by electromagnetic pollution. As a result the FCC was charged with the responsibility of promulgating rules and regulations to control and enforce limits on high frequency interference.

Figure 1 shows the current radiation limits as defined by FCC Rules Part 15, for class A (industrial) and class B (mass-market) equipment.

Contrary to the times when these regulations were first enforced and designing for EMI protection was often an afterthought rather than a forethought, a major portion of today's circuitry is incorporating EMI safeguards in its initial design. Many approaches can be used to comply with design or specification limits for EMI. Attention to basic circuit design, component layout, shielded enclosures and other use of shielding materials may be considered. For reducing or eliminating conducted EMI on printed circuit boards in wiring and cables, ferrite components have been used very successfully for decades. The ferrite core introduces into the circuit a frequency variable impedance, see Figure 2. The core will not affect the lower frequency operating signals but does block the conduction of the EMI noise frequencies. The Figures 3 and 4 are photographs of a representative sampling of the Fair-Rite Products Corp. product line of suppressor cores.

Conducted Limits*		
Frequency	Class A	Class B
450 kHz – 1.6 MHz	60 dBuV	50 dBuV
1.6 MHz – 30 MHz	70 dBuV	60 dBuV

\*Measured using a 50-ohm LISN

Radiated Limits**		
Frequency	Class A	Class B
30 MHz – 88 MHz	50 dBuV/m	40 dBuV/m
88 MHz – 216 MHz	53 dBuV/m	43 dBuV/m
216 MHz – 960 MHz	56 dBuV/m	46 dBuV/m
above 960 MHz	64 dBuV/m	54 dBuV/m

\*\*Measured at a 3-meter distance

Figure 1 FCC Radiation Limits for class A & B equipment.

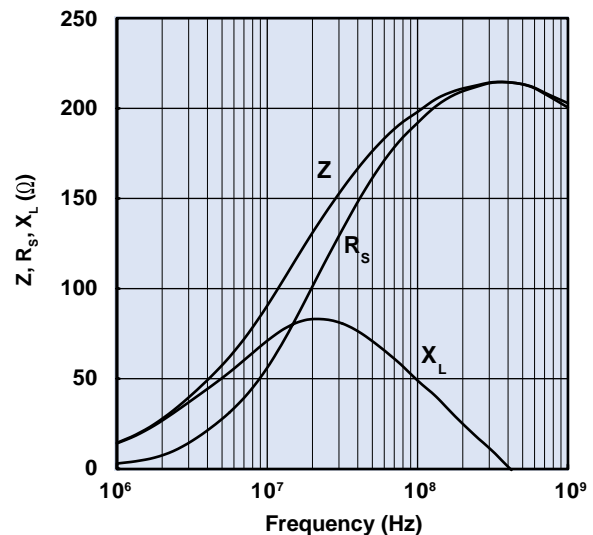
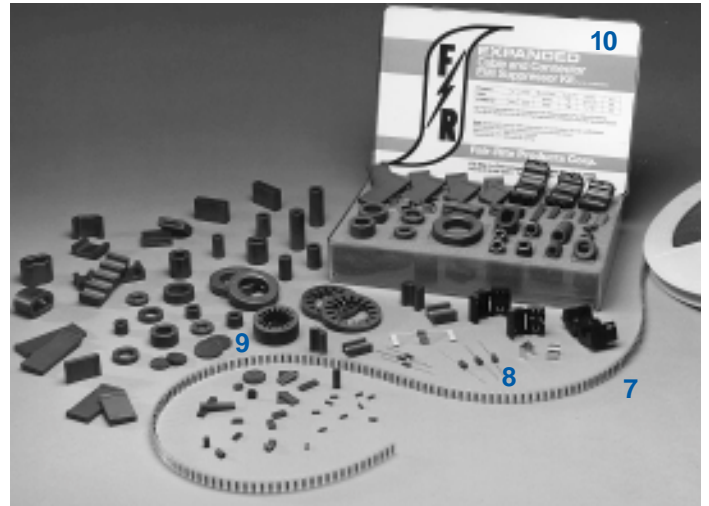
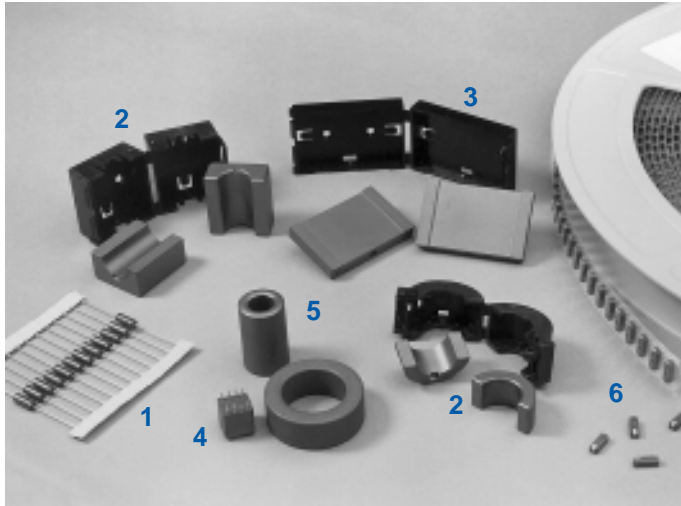


Figure 2 Impedance, reactance, and resistance vs. frequency for a ferrite core in 43 material.

# Technical Information



**Figure 3, 4** Variety of EMI Suppression Cores including: (1) Beads on Leads, (2) Split Round Cable Suppression Cores and Cases, (3) Split Flat Cable Suppression Cores and Cases, (4) Printed Circuit (PC) Beads, (5) Toroidal Type Shield Beads, (6) Surface-Mount (SM) Beads, (7) on Reel, (8) Wound Beads, (9) Connector Suppression Discs and Plates and (10) One of nine Engineering Kits containing a Large Variety of Samples of EMI Suppressor Cores.

## The Magnetics

The permeability of a ferrite material is a complex parameter consisting of a real and an imaginary part. The real component represents the reactive portion and the imaginary component represents the losses. These may be expressed as series components ( $\mu_s', \mu_s''$ ) or parallel components ( $\mu_p', \mu_p''$ ).

Figure 5 is the vector representation of the series equivalent circuit of a ferrite suppression core; the loss free inductor ( $L_s$ ) is in series with the equivalent loss resistor ( $R_s$ ). The following equations relate the series impedance and the complex permeability:

$$Z = j\omega L_s + R_s = j\omega L_o(\mu_s' - j\mu_s'') \text{ ohm}$$

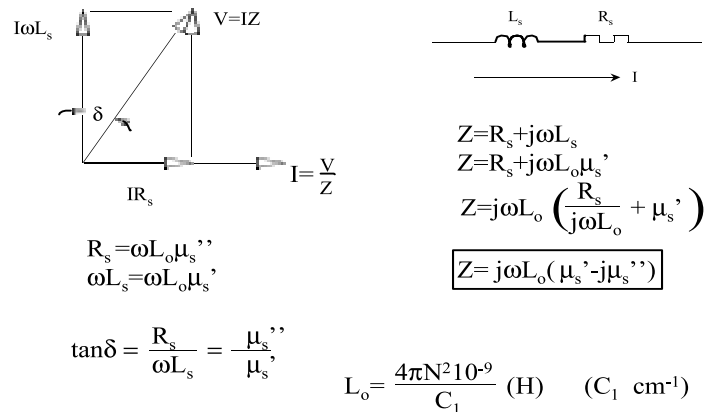
so that

$$\omega L_s = \omega L_o \mu_s' \text{ ohm}$$

$$R_s = \omega L_o \mu_s'' \text{ ohm}$$

where:  $L_o = \frac{4\pi N^2 10^{-9}}{C_1}$  (H) is the air core inductance.

The impedance of a ferrite suppressor core is a combination of the intrinsic material characteristics  $\mu_s'$  and  $\mu_s''$ , the square of the turns and of the ferrite core. The complex permeability components  $\mu_s'$  and  $\mu_s''$  vary as a function of frequency. The core geometry and the number of turns are frequency independent contributors to the overall impedance.



**Figure 5**

## Material Selection

Conducted EMI can occur over a wide range of frequencies, from as low as 1 MHz to several GHz. To provide protection over such a wide frequency range a number of ferrite materials will have to be made available.

Fair-Rite offers a complete line of suppression ferrites that cover a gamut of frequencies. Starting at 1 MHz MnZn ferrites 73 and 31 are used. Beginning around 20 MHz up to 200/300 MHz the NiZn materials 43 and 44 are recommended. For the highest frequencies the NiZn 61 material is the choice.

# Technical Information

Figures 6 through 10 show for these five suppression materials the complex permeabilities  $\mu'_s$  and  $\mu''_s$  as a function of frequency. For all these materials at low frequencies  $\mu'_s$  is highest but as the frequency increases  $\mu''_s$  becomes the dominant material parameter when the biggest contributor to the overall impedance. At the low frequencies where  $\mu'_s$  is highest the suppression core is mostly inductive and rejects EMI signals. At the higher frequencies where  $\mu''_s$  becomes the more significant parameter the impedance will become more and more resistive and absorbs the conducted EMI.

Table 1 lists Fair-Rite's suppression materials, suggested operating frequency ranges and the test frequencies for the five suppression materials. The recommended materials will provide the highest combination of the primary material characteristics  $\mu'_s$  and  $\mu''_s$  over that frequency range.

**Table 1**

Material	Frequency Range	Test Frequencies	Comments
73	1–25 MHz	10–25 MHz	Small parts only
31	1–300 MHz	10–25–100 MHz	Large parts only
43	20–300 MHz	25–100 MHz	Wide range of parts
44	20–300 MHz	25–100 MHz	High resistivity
61	200+ MHz	100–250 MHz	For VHF designs

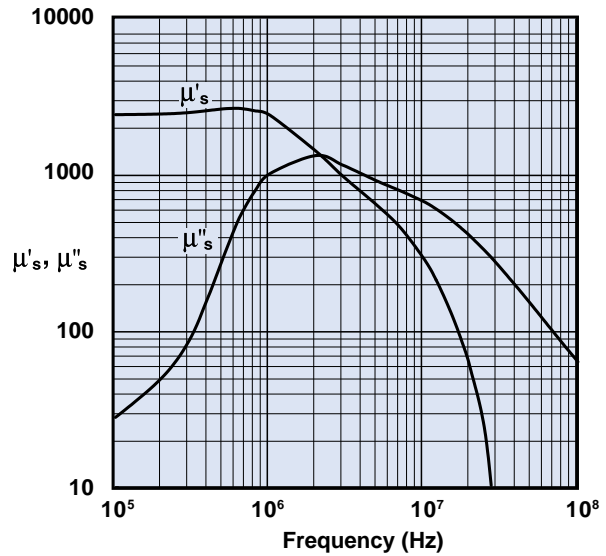
Making the material selection is the first step in eliminating conducted EMI problems. To make this material selection it is imperative that the frequency or frequencies of the unwanted noise are known. This needs not be an exact figure; an approximation will be sufficient. From the EMI frequency the material can be selected. It should be made clear that several environmental conditions will have to be addressed before this selection becomes final.

## Environmental Conditions

As shown in Figures 6 through 10, the  $\mu'_s$  and  $\mu''_s$  will vary as a function of frequency. However, several environmental conditions will also affect these primary material parameters. The most significant ones are temperature and dc bias.

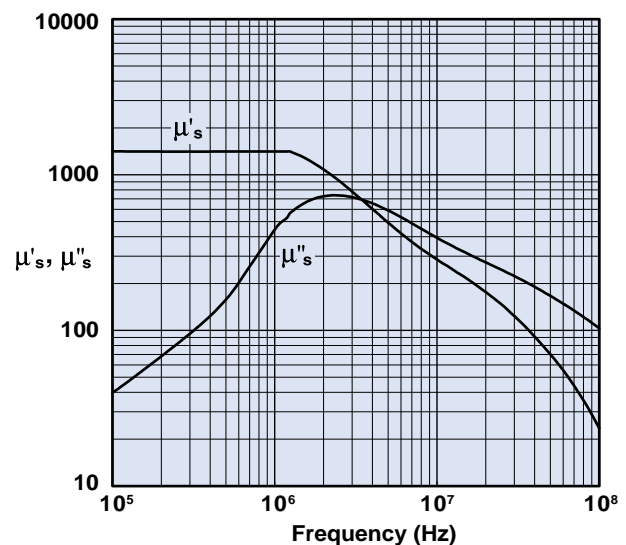
Changes in the combination of  $\mu'_s$  and  $\mu''_s$  due to temperature is strictly a material characteristic which is not affected by the core geometry. The graphs in Figures 11 through 15 show the percentage change in impedance as a function of temperature when compared to room temperature. These typical changes in impedance will be applicable for all components made from these materials. Designers can use these graphs to evaluate performance of specific components versus temperature.

**73 Material**



**Figure 6** Complex Permeability vs. Frequency Measured on a 2673000301 bead using the HP 4284A and the HP 4291A.

**31 Material**

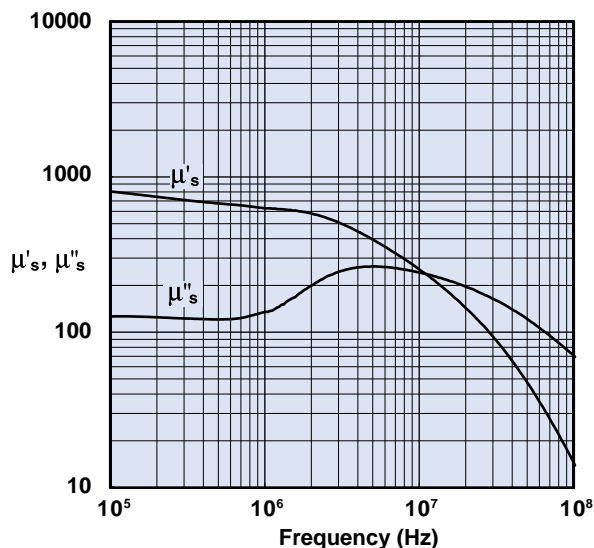


**Figure 7** Complex Permeability vs. Frequency Measured on a 17/10/6mm toroid using the HP 4284A and the HP 4291A.



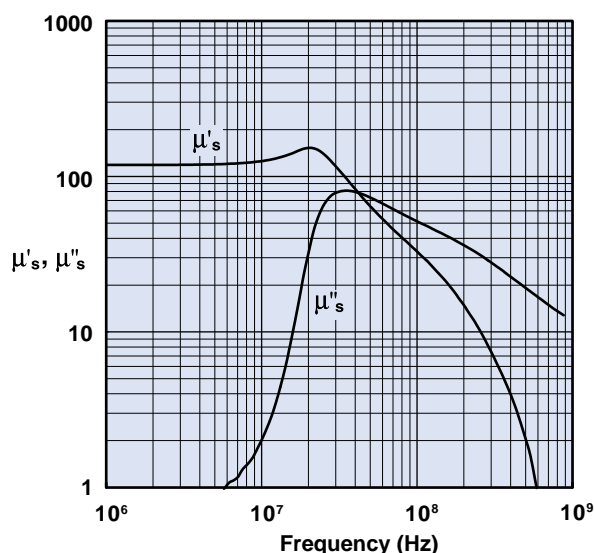
# Technical Information

**43 Material**



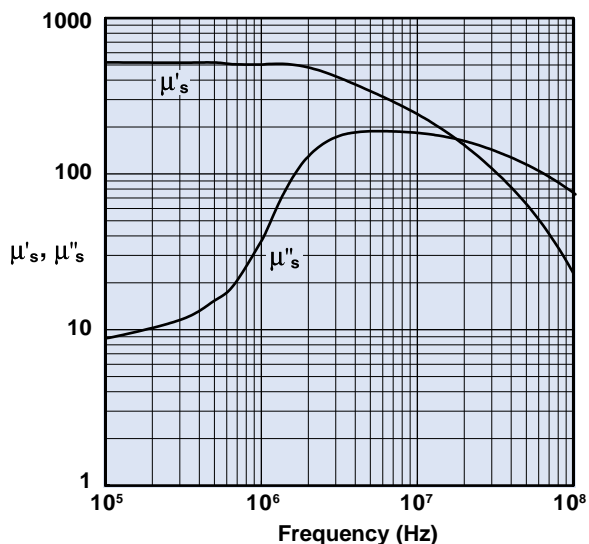
**Figure 8** Complex Permeability vs. Frequency Measured on a 17/10/6mm toroid using the HP 4284A and the HP 4291A.

**61 Material**



**Figure 10** Complex Permeability vs. Frequency Measured on a 17/10/6mm toroid using the HP 4284A and the HP 4291A.

**44 Material**



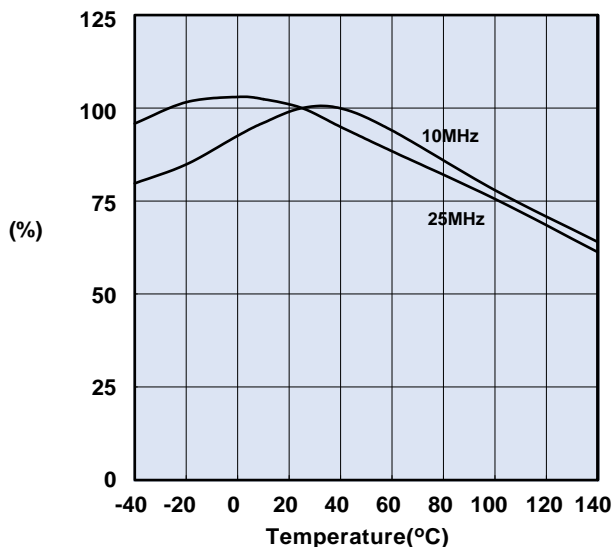
**Figure 9** Complex Permeability vs. Frequency Measured on a 17/10/6mm toroid using the HP 4284A and the HP 4291A.

The dc bias is more complex. The dc bias will affect both the  $\mu'_s$  and  $\mu''_s$ , but this is also influenced by the core geometry, specifically the magnetic path length. Therefore Fair-Rite provides dc bias information based on a dc H field in oersted for many of its suppression components. For all EMI suppression beads and round cable suppression cores listed in the catalog a calculated H value ( $H=1.256/I_m$ ) that is based on a single turn and one Amp direct current is shown. This calculated value of H should be modified if more turns are used or if the current is not 1 A. A 2 Amp current will of course double the value listed for the part. Once the true dc H field is calculated, graphs in Figures 16 through 20 will provide the change in impedance information for the appropriate material, frequency and true H value.

Dc bias curves are included in this catalog for wound and assembled parts as well as for those components for which the magnetic path length cannot be easily calculated. For instance, refer to the product sections for beads on leads, pages 29-40 and chip beads, pages 50-73. For each individual component an impedance vs. frequency curve with the dc bias as a parameter is included. Again, this will provide the designer with a quick evaluation on how the dc affects the performance of these components.

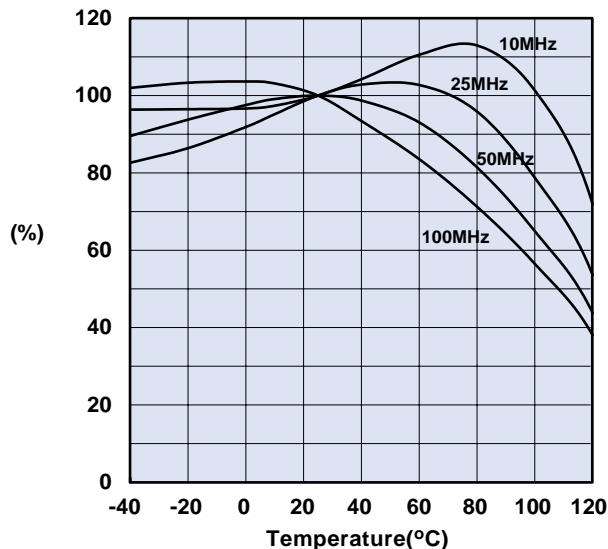
# Technical Information

**73 Material**



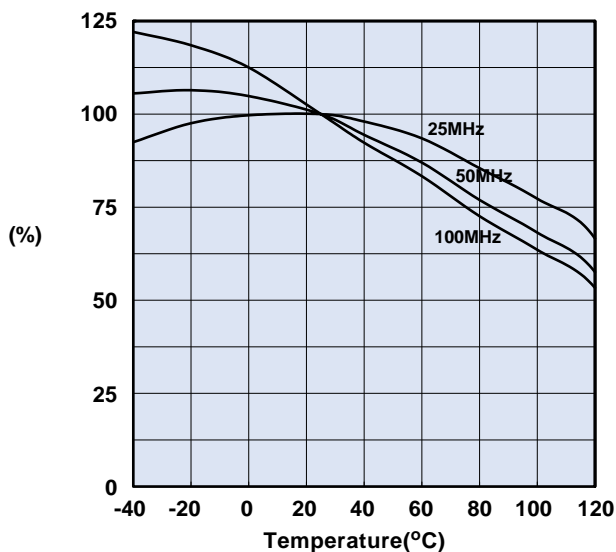
**Figure 11** Percent of Original Impedance vs. Temperature Measured on a 2673000301 using the HP4291A.

**31 Material**



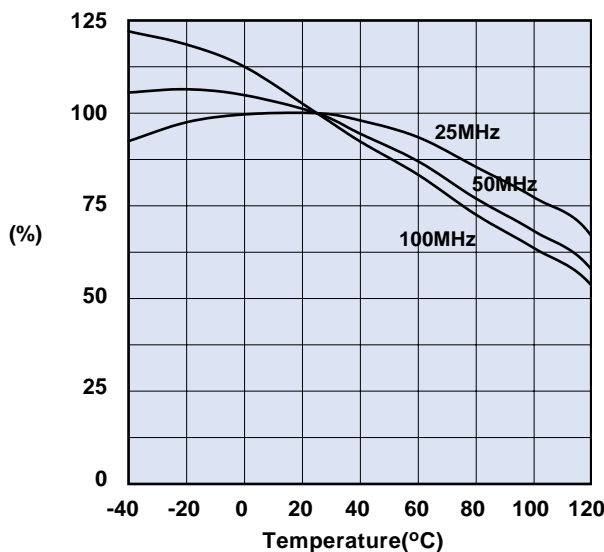
**Figure 12** Percent of Original Impedance vs. Temperature Measured on a 2631000301 using the HP4291A.

**43 Material**



**Figure 13** Percent of Original Impedance vs. Temperature Measured on a 2643000301 using the HP4291A.

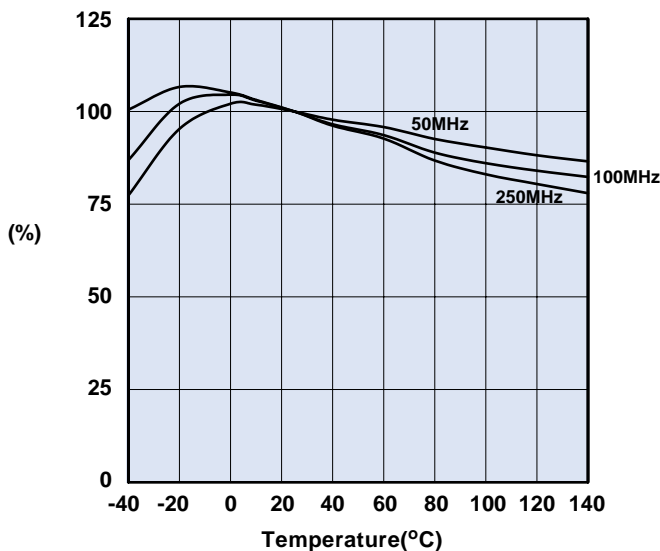
**44 Material**



**Figure 14** Percent of Original Impedance vs. Temperature Measured on a 2644000301 using the HP4291A.

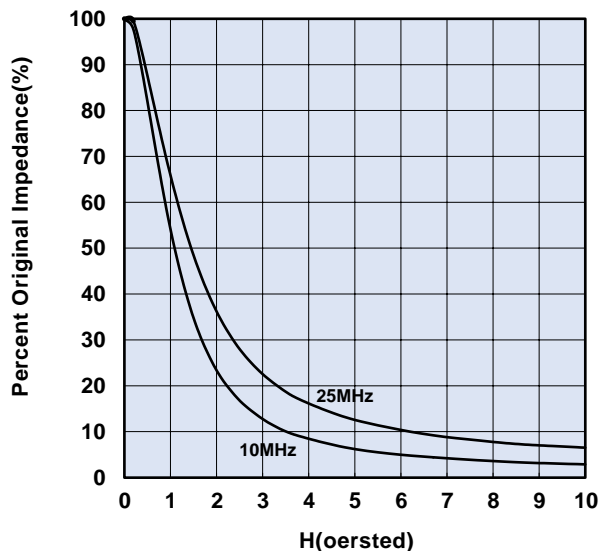
# Technical Information

**61 Material**



**Figure 15** Percent of Original Impedance vs. Temperature Measured on a 2661000301 using the HP4291A.

**73 Material**



**Figure 16** Percent of Original Impedance vs. Magnetic Field Strength. Measured on a 2673000301 using the HP4291A.

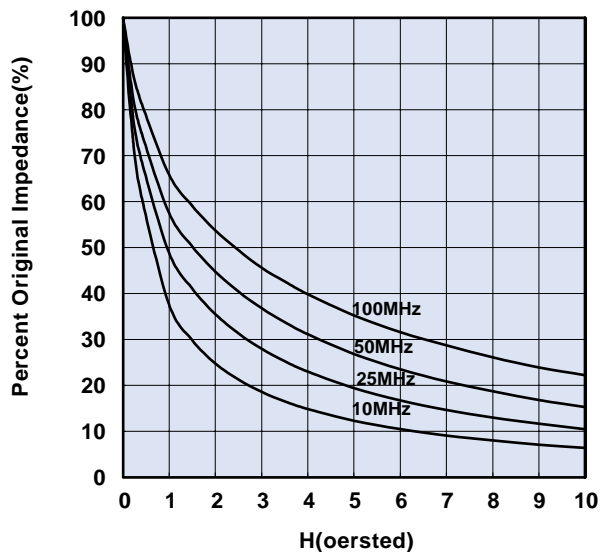
## Secondary Material Parameters

Although  $\mu'_s$  and  $\mu''_s$  are the most critical material characteristics for suppression applications, resistivity and Curie temperature are ferrite material parameters that should be considered as well.

The Curie temperature is the transition temperature above which the ferrite loses its magnetic properties. At this temperature the component is no longer performing its intended function. Once the material cools down below this temperature it will again perform as before. For all Fair-Rite materials a minimum Curie temperature is specified.

As mentioned previously, Fair-Rite manufactures two classes of ferrite materials, MnZn and NiZn ferrites. The manganese zinc materials have low resistivities whereas the nickel zinc materials have high resistivities. For applications that use non-insulated wires or for use as connector suppression plates, a ferrite material with the highest resistivity is recommended. Fair-Rite's 44 material is an improved 43 material by providing both increased resistivity and Curie temperature. Components in the 44 NiZn material are catalog standard parts for connector plates and wound parts such as PC beads and wound beads.

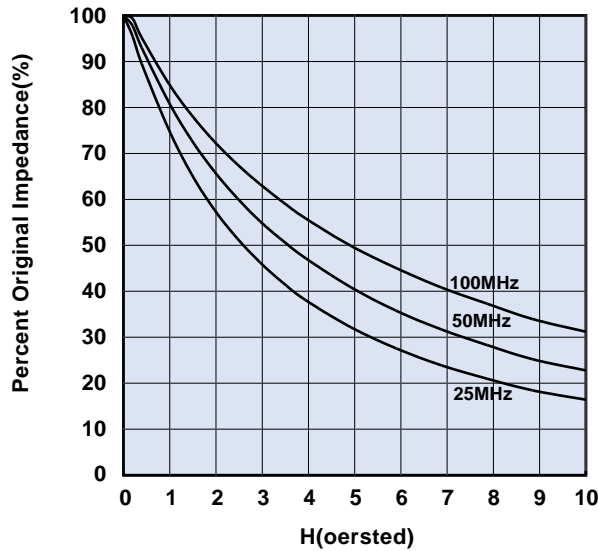
**31 Material**



**Figure 17** Percent of Original Impedance vs. Magnetic Field Strength. Measured on a 2631000301 using the HP4291A.

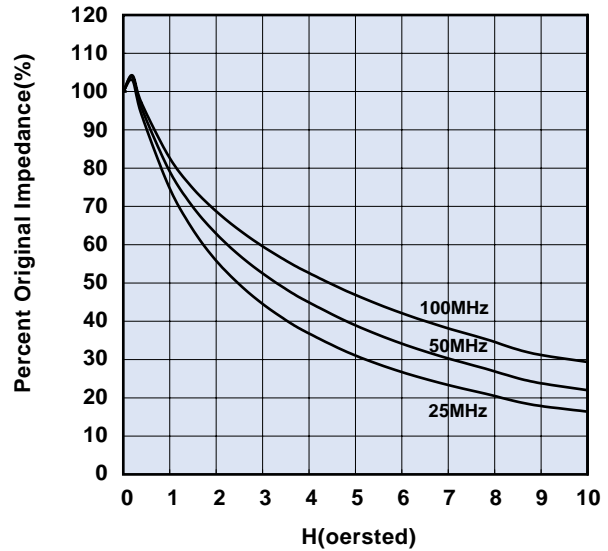
# Technical Information

**43 Material**



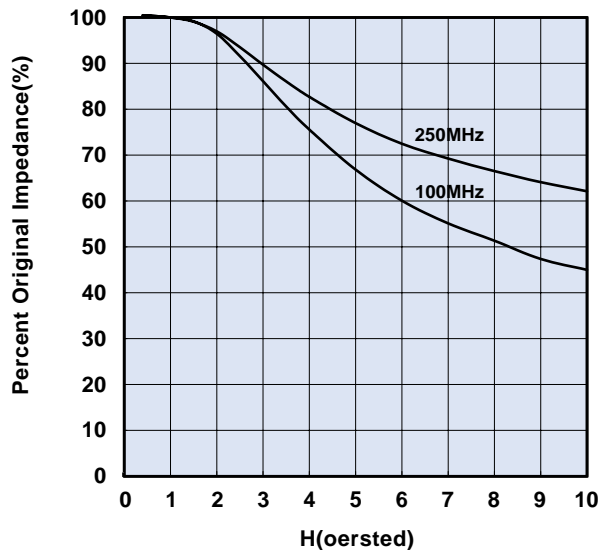
**Figure 18** Percent of Original Impedance vs. Magnetic Field Strength. Measured on a 2643000301 using the HP4291A.

**44 Material**



**Figure 19** Percent of Original Impedance vs. Magnetic Field Strength. Measured on a 2644000301 using the HP4291A.

**61 Material**



**Figure 20** Percent of Original Impedance vs. Magnetic Field Strength. Measured on a 2661000301 using the HP4291A.

## Common-Mode Design

If the dc currents are so high that the resulting impedances are not sufficient to suppress the conducted noise, the common-mode approach might solve the problem. As shown in Figure 21, in a common-mode design both current-carrying conductors will pass through the same hole in the core. The dc fields will cancel and the common-mode noise that is picked-up on both lines will be attenuated. It should be pointed out that an EMI signal that is on the line to the load and then returns from the load will not "see" the core and will not be attenuated.

In applications with a large direct current in a single conductor, the solution might be the use of an open magnetic circuit core such as a wound ferrite rod. In automotive designs where the ground is used as the return path, this often is the only option.

When high frequency operating signals, typically above 1 MHz, are susceptible to EMI, the common-mode approach might be used to solve that problem. In this instance common-mode is not used for the current compensation, but rather for the compensation of the high frequency signals. These signal pairs will be not be suppressed, yet any common-mode EMI will be attenuated. The use of round or flat cable cores is a good example of this application of this type of common-mode suppression.

# Technical Information

## Common-Mode Design

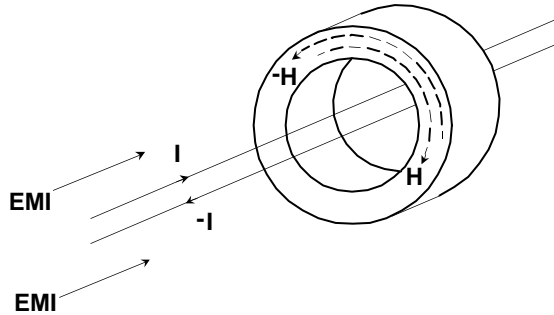


Figure 21

## Core Selection

Once the proper ferrite material for a specific suppression application has been decided the required ferrite core is the next step in solving the EMI problem. The core contribution to the impedance is expressed in the formula

$$L_o = \frac{4\pi N^2 10^{-9}}{C_1} \text{ (H)}$$

From this formula it is evident that the impedance is proportional to the square of the number of turns and the core geometry shown by the core constant  $C_1$ . The advantage of the proportionality of  $N^2$  is often overlooked and yet can enhance the overall impedance significantly for a rather minor cost. Figure 22 shows the impedance versus frequency curves for one of Fair-Rite's 43 material cable cores wound with one, two and three turns. By increasing the number of turns the winding capacitance is increased resulting in a shift in the maximum impedance to lower frequencies. If an improvement of the low frequency impedance performance is needed, this increase in turns can be very beneficial for the 43 material applications.

The core geometry most often used in suppression applications is the toroidal core. When the dimensions are in inches, the  $L_o$  for the toroidal core shape is  $1.17 N^2 H \log_{10} OD/ID 10^{-8} \text{ (H)}$ . Of the three core dimensions  $OD$ ,  $ID$  and  $H$  (height), the  $H$  is the most significant. This dimension is proportional to the toroidal  $L_o$  and hence of the impedance of the core. Doubling  $H$  will double the volume and also the impedance. Doubling the core volume by changing the  $OD$  and or the  $ID$  will only increase the impedance by approximately 40%.

Overall the process of selecting a bead or cable core that fits the wire or cable is mainly a mechanical evaluation, but the longer the selected core the higher the impedance for a given volume of ferrite material.

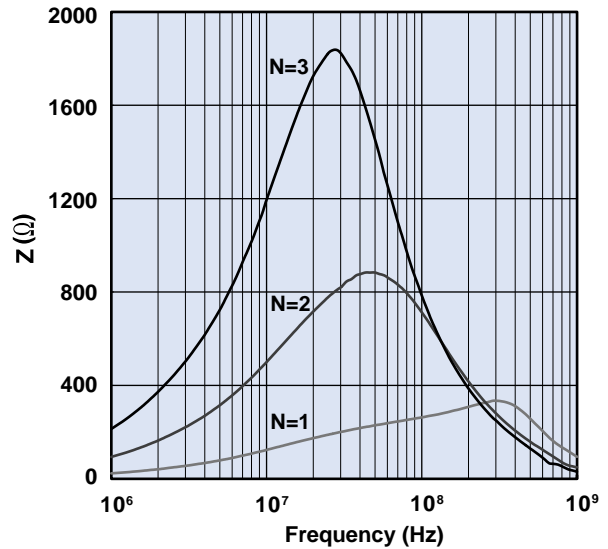


Figure 22 Impedance vs. frequency for a 14/6/28mm cable core in 43 material wound with one, two, and three turns.

## Suppression Materials

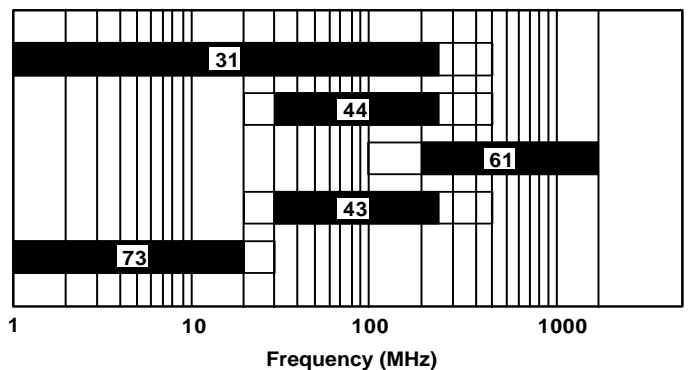


Figure 23 Available Fair-Rite Suppression Materials vs. Frequency

# Technical Information

## Suppressing Common-Mode Noise

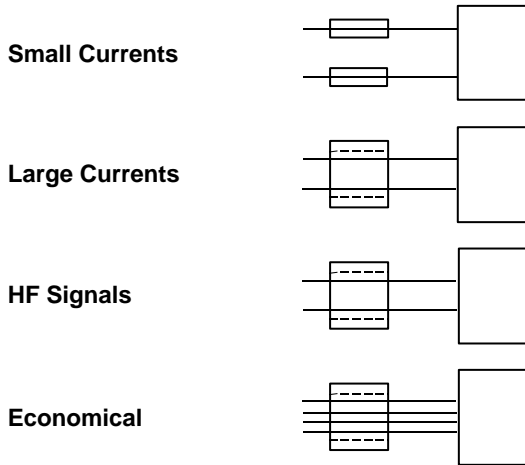


Figure 24

## Suppressing Differential-Mode Noise

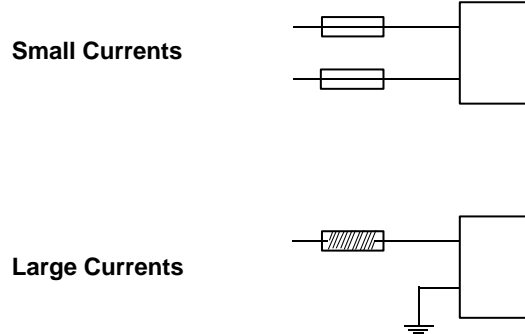


Figure 25

## Summary

### 1. Material Selection

The graph in Figure 23 aids in the initial material selection for suppressing conducted EMI frequencies.

DC bias, core size, operating temperature and resistance requirements might affect this choice.

### 2. Core Selection

To make a final core selection, the type of EMI, common-mode or differential-mode, will affect the choice of the core configuration.

Figures 24 and 25 provide an overview of the available core shape options for different levels of input currents.

**Although the catalog lists hundreds of suppression components, we at Fair-Rite Products Corp. will manufacture parts to fit customer specific applications. Contact one of our representatives or our sales office in Wallkill, NY with your requirements.**

# Technical Information

## Ferrite Tile Absorbers for EMC Test Chamber Applications



### Introduction

Fair-Rite's tile absorbers provide an attractive alternative to traditional large, foam-type absorber materials for new anechoic chambers or for upgrading older rooms for radiated emission and immunity measurements. While ferrite tiles are a relatively recent development, they have come into use wherever high absorption (-15 to -25 dB at <100 MHz) and compact size (6mm vs 2400mm for foam absorbers) are required. There are now hundreds of installations worldwide in compact and 3/10 meter FCC certified chambers. Ferrites themselves are inherently immune to fire, humidity and chemicals providing a reliable and compact solution for attenuating plane wave reflections in shielded enclosures.

### Theory of Operation

The basic physics of operation for any planar electromagnetic absorber involves fundamental concepts as shown in Figure 1. When an electromagnetic wave traveling through free-space encounters a different medium (at Z=0), the wave will be reflected, transmitted, and/or absorbed. It is of course, the magnitude of the reflected signal which is usually of interest in this application. For ferrite tiles, the thickness is tuned so that the relative phases of the reflected and exiting wave cancel to form a resonant condition. This resonant condition appears as a deep "null" in the return loss response. This resonance is also a function of the frequency dependent electrical properties of the ferrite material such as relative permeability ( $\mu_r$ ) and permittivity ( $\epsilon_r$ ) which interact to determine the reflection coefficient ( $\Gamma$ ), impedance (Z) and return loss (RL) according to the following formulas:

$$Z_f = \sqrt{\frac{\mu_r}{\epsilon_r}} \cdot \tanh \left[ \left( \frac{j2\pi d}{\lambda} \right) \left( \sqrt{\mu_r \epsilon_r} \right) \right] \quad (\text{ohm})$$

$$\Gamma = \frac{Z_f - Z_0}{Z_f + Z_0}$$

$$RL = 20 \log_{10} (\Gamma) \quad (\text{dB})$$

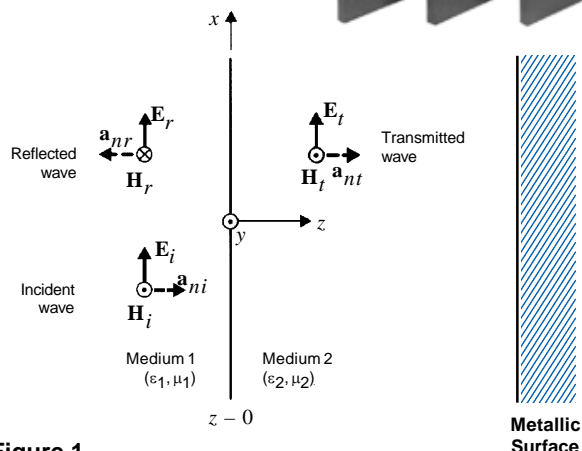


Figure 1

Where :

- $\mu_1$  = relative permeability of medium 1 (air)
- $\epsilon_1$  = relative permittivity of medium 1 (air)
- $\mu_2$  = relative permeability of medium 2 (ferrite)
- $\epsilon_2$  = relative permittivity of medium 2 (ferrite)
- $\Gamma$  = reflection coefficient of metal backed ferrite tile
- $Z_f$  = input impedance of metal backed ferrite tile
- $Z_0$  = impedance of free space (air)
- $E_i, H_i$  = components of incident plane wave
- $E_r, H_r$  = reflected components of incident plane wave
- $E_t, H_t$  = transmitted components of incident plane wave
- $d$  = thickness of medium 2 (ferrite)

### Increasing Bandwidth

For some chamber applications increased absorber bandwidth may be desired to comply with high frequency testing needs. One technique shown in Figure 2 increases the bandwidth of ferrite tile installations by mounting the tile over a dielectric spacer (typically wood) of appropriate thickness. When both tile and spacer thicknesses are optimized, the frequency response is shifted upward to improve return loss performance from 600-1500 MHz (see Figure 3). Of course, if increased bandwidth up to 20 GHz is desired, several absorber vendors provide completely engineered hybrid absorbers using specially designed pyramidal and wedge shaped dielectric absorbers matched to ferrite tiles.

# Technical Information

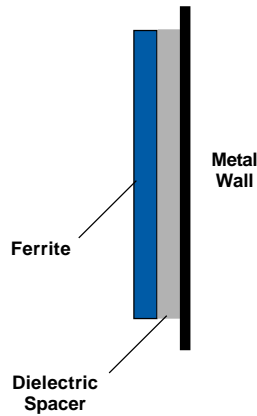


Figure 2

### Typical Return Loss with Dielectric Spacer

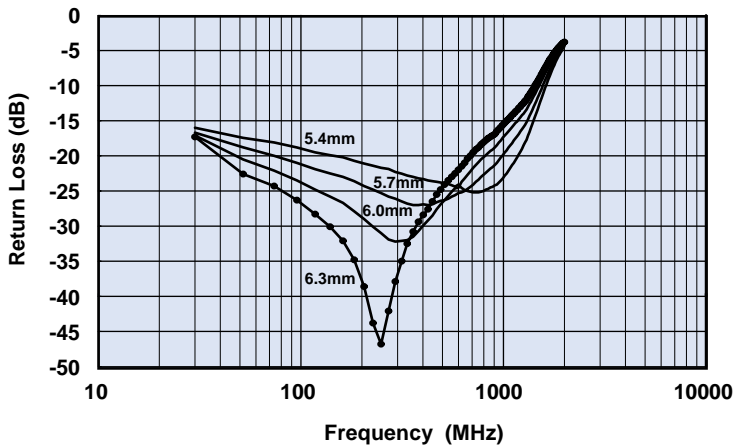


Figure 3 Spacer Thickness = 13mm

### Wide Angle Absorption

One of the most overlooked aspects of using any absorber is the rolloff of absorption with increasing angle of incidence. Most published absorber data contains only normal incidence return loss (dB) which is typically where the maximum absorption is obtained. Normal incidence is defined as plane wave radiation arriving perpendicular (0°) to the plane of the absorbing surface. The curves in Figure 4 were generated using equations described in IEEE document "Recommended Practice for RF Absorber Evaluation in the range 30 MHz to 5 GHz". Since the reflections occurring in anechoic chambers seldom illuminate absorber materials at 0°, it is important to consider the reflection angles generated by each chamber geometry and size for best results. For most chambers, the range of angles is in the 40-60° range, however it is usually desirable to operate at < 50°.

Return loss vs angle of incidence for TM polarization is shown in Figure 4. Return loss curves for TE polarization (not shown) are similar.

### Wide-Angle Return Loss – TM Polarization

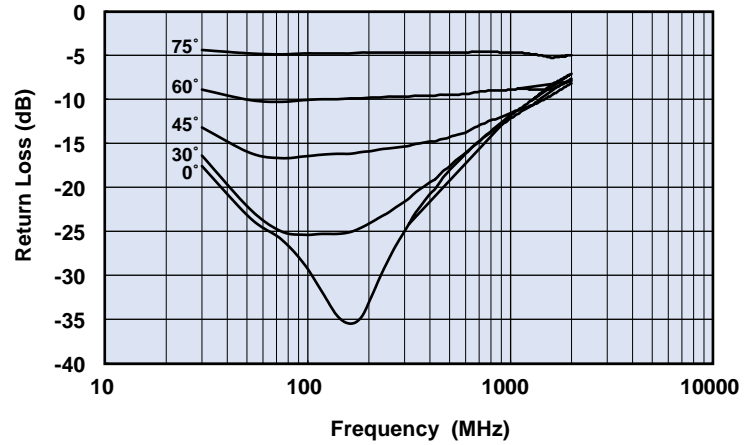


Figure 4

### Precision Dimensions

Studies have shown that maximum low-frequency performance is obtained when tile to tile gaps are minimized. Fair-Rite precisely machines each of the six surfaces to  $\pm 0.13\text{mm}$  (.005") to ensure a tight tile to tile fit for easier installation with less cutting required. Figure 5 illustrates the effect of gaps on tile performance when installed with: no gap (0mm), .25mm and 1.0mm. It is critical to maintain contact between tiles for best results. The final results of the completed test chamber will also be degraded by other factors such as lights, gaps around door openings, and exposed metallic conduit.

### Reflectivity vs. Tile – Tile Gap Size

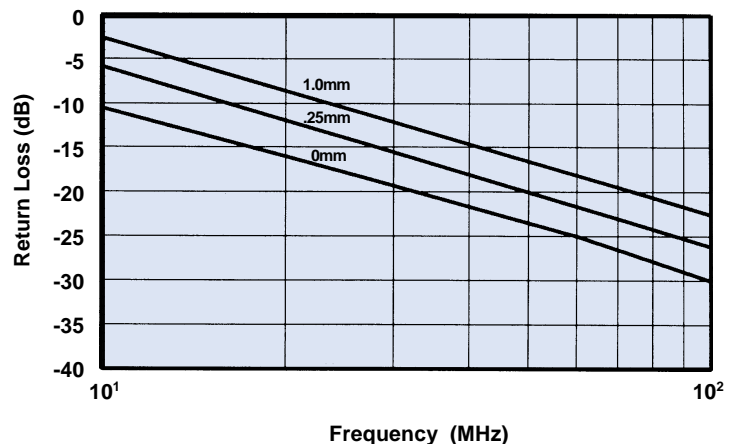


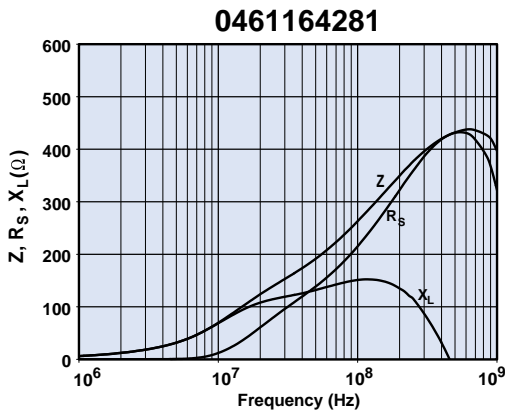
Figure 5



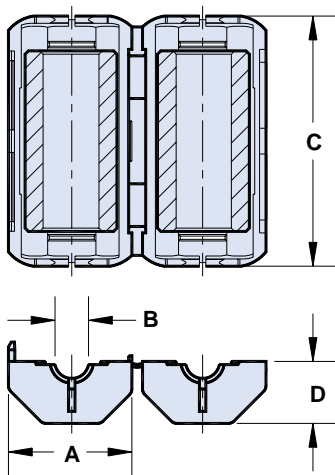
# News from Fair-Rite...

## High Frequency Split Round Cable Suppressor Cores

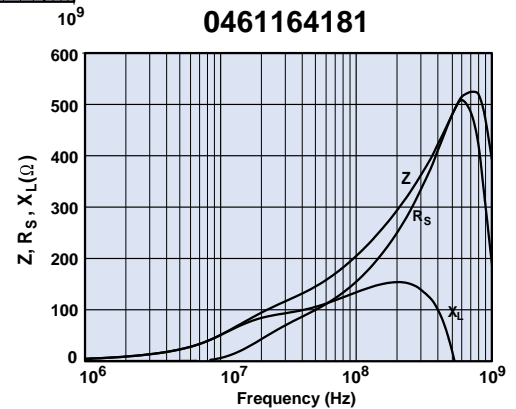
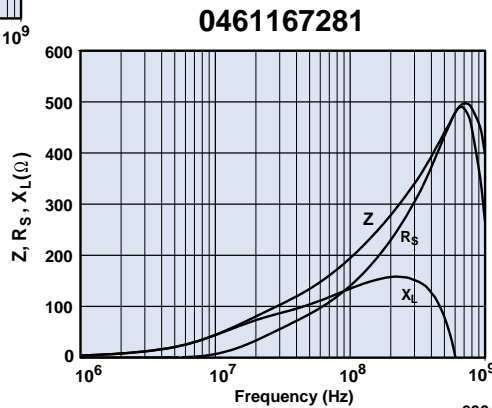
Now available in 61material for attenuating frequencies of 250 MHz and above.



Available in sizes to fit a range of cable diameters and installed around a cable, these cores provide common-mode filtering for multi-strand cables and differential mode filtering for single conductors.



Polypropylene Cases having a flammability rating of UL94-V0 makes assembling the core halves a snap.



Dimensions (Bold numbers are in millimeters, light numbers are nominal in inches.)

Part Number	Cable Diameter	A	B*	C	D	Impedance $\Omega$ **		
						100MHz	250MHz	500MHz
<b>0461164281</b>	<b>7.0 Max</b> .275 Max	<b>20.0</b> .788	<b>6.6</b> .260	<b>39.4</b> 1.55	<b>9.78</b> .385	270	395	430
<b>0461167281</b>	<b>10.5 Max</b> .410 Max	<b>23.7</b> .933	<b>10.2</b> .400	<b>39.4</b> 1.55	<b>11.7</b> .461	195	315	455
<b>0461164181</b>	<b>13.3 Max</b> .525 Max	<b>31.0</b> 1.220	<b>13.0</b> .512	<b>39.4</b> 1.55	<b>15.25</b> .600	205	335	475

\* B Dimension is the core dimension

\*\* Typical Value. Z min is Z typ -20%

Scroll down and click on part number or use CTR F to find part.

<u>Part Number</u>	<u>Page</u>	<u>Part Number</u>	<u>Page</u>	<u>Part Number</u>	<u>Page</u>	<u>Part Number</u>	<u>Page</u>
0199000005	92	0443806406	103	2512061017Y0	51	2631540002	94
0199000017	92	0444164181	103	2512061027Y0	51	2631540202	94
0199000018	92	0444164281	103	2512061217Y0	51	2631625002	95
0199000019	92	0444164951	103	2512061527Y0	51	2631625102	95
0199000020	92	0444167281	103	2512061907Y1	52	2631626302	95
0199000024	92	0444173551	103	2512063007Y0	51	2631626402	95
0199000025	92	0444173951	103	2512063007Y3	52	2631665702	95
0199000027	92	0444176451	103	2512063017Y0	51	2643000101	25
0199000028	92	0444177081	103	2512065007Y0	51	2643000201	25
0199001401	115	0461164281	185	2512065007Y3	52	2643000301	25
0199010301	115	0461167281	185	2512065007Y6	52	2643000501	25
0199016051	115	0461164181	185	2512066007Y0	51	2643000701	26
0199016551	115	2506031017Y0	51	2512066017Y0	51	2643000801	27
0199163951	115	2506031027Y0	51	2512066017Y1	52	2643001301	27
0199164051	115	2506031217Y0	51	2512067007Y0	51	2643001501	26
0199164151	101	2506031217Z0	51	2512067007Y3	52	2643001601	26
0199164251	101	2506031517Y0	51	2512068007Y0	51	2643002201	25
0199166651	115	2506033007Y0	51	2518068007Y1	52	2643002402	27
0199167251	101	2506033007Y1	52	2518068007Y6	52	2643003201	27
0199173551	101	2506033017Y0	51	2512069007Y0	51	2643004101	24
0199625006	101	2506033017Z0	51	2518061017Y0	51	2643004201	24
0199665806	101	2506036007Y0	51	2518061517Y0	51	2643004601	24
0199800506	101	2506036007Z0	51	2518063017Y0	51	2643004701	24
0199806406	101	2506036017Y0	51	2518065007Y6	52	2643004801	25
0431163951	116	2506038007Y0	51	2518066007Y0	51	2643005701	27
0431164051	116	2506039007Y0	51	2518066007Y3	52	2643006302	27
0431164181	103	2508051017Y0	51	2518067007Y0	51	2643012702	27
0431164281	103	2508051027Y0	51	2518068007Y0	51	2643013801	26
0431164951	103	2508051107Y0	51	2518068007Y1	52	2643020501	25
0431167281	103	2508051217Y0	51	2518068007Y6	52	2643021801	26
0431173551	103	2508051217Z0	51	2518121217Y3	52	2643022401	26
0431173951	103	2508051527Y0	51	2518121217Y6	52	2643023002	27
0443163951	116	2508051817Y0	51	2518127007Y3	52	2643023201	26
0443164051	116	2508053007Y3	52	2631101902	96	2643023402	27
0443164151	103	2508053017Y0	51	2631102002	96	2643023801	26
0443164251	103	2508053017Z0	51	2631163851	109	2643025601	26
0443166651	116	2508055007Y0	51	2631163951	109	2643101902	96
0443167251	103	2508056007Y0	51	2631164051	109	2643102002	96
0443625006	103	2508056007Z0	51	2631250202	27	2643102402	96
0443665806	103	2508056017Y0	51	2631480002	94	2643163851	109
0443800506	103	2508059007Y0	51	2631480102	94	2643163951	109

# Numerical Index

<u>Part Number</u>	<u>Page</u>	<u>Part Number</u>	<u>Page</u>	<u>Part Number</u>	<u>Page</u>	<u>Part Number</u>	<u>Page</u>
2643164051	109	2643375102	27	2644173551	98	2661666611	79
2643164151	98	2643480002	94	2644236001	121	2673000101	25
2643164251	98	2643480102	94	2644236101	121	2673000201	25
2643164551	109	2643540002	94	2644236301	121	2673000301	25
2643165151	118	2643540102	94	2644236401	121	2673000501	25
2643165451	98	2643540202	94	2644236501	121	2673000701	26
2643166251	118	2643540302	95	2644236601	121	2673000801	27
2643166451	109	2643540402	95	2644245601	121	2673001601	26
2643166551	109	2643540702	94	2644245701	121	2673002201	25
2643166651	109	2643625002	95	2644245801	121	2673002402	27
2643166751	98	2643625006	98	2644245901	121	2673003201	27
2643166851	109	2643625102	95	2644246001	121	2673004601	24
2643167051	109	2643625202	95	2644246101	121	2673004701	24
2643167251	98	2643625902	96	2644246201	121	2673004801	25
2643167551	109	2643626002	96	2644246301	121	2673004901	26
2643167751	109	2643626102	96	2644246701	121	2673010101	25
2643167851	118	2643626202	96	2644246801	121	2673012401	25
2643168051	109	2643626302	95	2644246901	121	2673015301	27
2643168251	109	2643626402	95	2644247001	121	2673018001	26
2643168351	109	2643626502	95	2644247101	121	2673021801	26
2643168651	109	2643665702	95	2644247201	121	2673022401	26
2643168751	109	2643665802	95	2644247301	121	2673025001	25
2643169351	109	2643665806	98	2644247401	121	2673025301	25
2643169552	109	2643665902	95	2644247501	121	2673028602	25
2643170251	109	2643706001	25	2644251801	121	2673030101	25
2643170951	109	2643800302	95	2644251901	121	2673200201	27
2643171051	109	2643800502	96	2644373841	121	2673901301	24
2643171151	109	2643800506	98	2644373941	121	2673903301	24
2643171351	109	2643800602	96	2644666611	79	2743001111*	29
2643172551	109	2643801002	96	2644777711	79	2743001112	29
2643172751	109	2643801102	95	2661000101	25	2743002111*	30
2643173351	109	2643801202	96	2661000301	26	2743002112	30
2643173851	109	2643801402	96	2661000701	26	2743003111*	30
2643175451	118	2643801502	95	2661021801	26	2743003112	30
2643200101	26	2643801802	96	2661022401	26	2743004111*	30
2643250202	27	2643801902	95	2661023801	26	2743004112	30
2643250302	27	2643802702	96	2661102002	96	2743005111*	29
2643250402	27	2643803802	96	2661102402	96	2743005112	29
2643251002	96	2643804502	96	2661540002	95	2743007111*	30
2643300101	27	2643806402	96	2661540202	94	2743007112	30
2643375002	27	2643806406	98	2661665702	95	2743008111*	30

\* Part numbers are not listed in the tables but are identified in the italic notes.

**P.O. Box J, One Commercial Row, Wallkill, NY 12589-0288**

**Fair-Rite Products Corp.**

Phone: (888) FAIR RITE / (845) 895-2055 • FAX: (888) FERRITE / (845) 895-2629 • www.fair-rite.com • E-Mail: ferrites@fair-rite.com  
(888) 324-7748 (888) 337-7483 **Note: (914) Area Code has changed to (845).**

# Numerical Index

<u>Part Number</u>	<u>Page</u>	<u>Part Number</u>	<u>Page</u>	<u>Part Number</u>	<u>Page</u>	<u>Part Number</u>	<u>Page</u>
2743008112	30	2761009112	30	2843002702	84	2944778301	74
2743009111*	30	2761015111*	29	2843006802	85	2944778302	74
2743009112	30	2761015112	29	2843009902	85	2961666631	79
2743012201	30	2761019446*	42	2843010302	85	2961666634*	79
2743013211	30	2761019447	42	2843010402	85	2961666651	79
2743014221	30	2761021446*	42	2861000102	85	2961666654*	79
2743015111*	29	2761021447	42	2861000202	85	2961666661	79
2743015112	29	2773001111*	29	2861000302	85	2961666671	79
2743019446*	42	2773001112	29	2861001502	85	2961666681	79
2743019447	42	2773002111*	30	2861001702	85	3061990821	132
2743021446*	42	2773002112	30	2861001802	85	3061990831	132
2743021447	42	2773003111*	29	2861002302	84	3061990841	132
2743037446*	42	2773003112	29	2861002402	84	3061990851	132
2743037447	42	2773004111*	30	2861002702	84	3061990861	132
2744040446*	42	2773004112	30	2861006802	85	3061990871	132
2744040447	42	2773005111*	29	2861010002	85	3061990881	132
2744041446*	42	2773005112	29	2873000102	85	3061990891	132
2744041447	42	2773007111*	30	2873000202	85	3061990901	132
2744044446*	42	2773007112	30	2873000302	85	3061990911	132
2744044447	42	2773008111*	30	2873001502	85	3078990821	132
2744045446*	42	2773008112	30	2873001702	85	3078990831	132
2744045447	42	2773009111*	30	2873001802	84	3078990841	132
2744051446*	42	2773009112	30	2873002302	84	3078990851	132
2744051447	42	2773015111*	29	2873002402	84	3078990861	132
2744555576*	42	2773015112	29	2873002702	84	3078990871	132
2744555577	42	2773019446*	42	2873006802	85	3078990881	132
2761001111*	29	2773019447	42	2944666631	79	3078990891	132
2761001112	29	2773021446*	42	2944666634*	79	3078990901	132
2761002111*	30	2773021447	42	2944666651	79	3078990911	132
2761002112	30	2773037446*	42	2944666654*	79	3642011601	127
2761003111*	30	2773037447	42	2944666661	79	3642012401	127
2761003112	30	2773044446*	42	2944666671	79	3642014000	126
2761004111*	30	2773044447	42	2944666681	79	3742011901	127
2761004112	30	2843000102	85	2944770301	74	3742014000	126
2761005111*	29	2843000202	85	2944770302	74	3742014010	126
2761005112	29	2843000302	85	2944776101	74	4033032221	129
2761007111*	30	2843001502	85	2944776102	74	4033122011	129
2761007112	30	2843001702	85	2944777721	79	4033128021	129
2761008111*	30	2843001802	84	2944777741	79	4033129021	129
2761008112	30	2843002302	84	2944778101	74	4033266011	130
2761009111*	30	2843002402	84	2944778102	74	4033276011	130

\* Part numbers are not listed in the tables but are identified in the italic notes.

**Fair-Rite Products Corp.** P.O. Box J, One Commercial Row, Wallkill, NY 12589-0288

Phone: (888) FAIR RITE / (845) 895-2055 • FAX: (888) FERRITE / (845) 895-2629 • www.fair-rite.com • E-Mail: ferrites@fair-rite.com  
(888) 324-7748 (888) 337-7483 **Note: (914) Area Code has changed to (845).**

# Numerical Index

<u>Part Number</u>	<u>Page</u>	<u>Part Number</u>	<u>Page</u>	<u>Part Number</u>	<u>Page</u>	<u>Part Number</u>	<u>Page</u>
4033287011	129	5577001021	144	5943001401	139	5961001201	140
4033292011	130	5578000721	144	5943001421*	139	5961001221*	140
4033296011	130	5578000821	144	5943001601	140	5961001701	140
4061032221	129	5578000921	144	5943001621*	140	5961001721*	140
4061122011	129	5578001021	144	5943001701	140	5961001801	139
4061128011	129	5677140821	142	5943001721*	140	5961001821*	139
4061129011	129	5677181121	142	5943001801	139	5961001901	138
4061172011	129	5677221321	142	5943001821*	139	5961001921*	138
4061266011	130	5677261621	142	5943001901	138	5961002701	140
4061272011	129	5677301921	142	5943001921*	138	5961002721*	140
4061276011	129	5677362221	142	5943002101	136	5961003801	141
4061287011	129	5678090521	142	5943002111*	136	5961003821*	141
4061292011	130	5678110721	142	5943002701	141	5961004901	138
4061296011	130	5678140821	142	5943002721*	141	5961004921*	138
4077032221	129	5678181121	142	5943003801	141	5975000101	137
4077172011	129	5678221321	142	5943003821*	141	5975000111*	137
4077266011	130	5678261621	142	5943004901	138	5975000201	137
4077272011	129	5678301921	142	5943004921*	138	5975000211*	137
4077276011	130	5678362221	142	5943005101	138	5975000221*	137
4077287011	129	5678422921	144	5943005121*	138	5975000301	137
4077292011	130	5943000101	137	5943006401	140	5975000321*	137
4077296011	130	5943000111*	137	5943006421*	140	5975000501	139
4077312911	130	5943000201	137	5943007601	139	5975000521*	139
4077374711	130	5943000211*	137	5943007621*	139	5975000601	139
4077375211	130	5943000221*	137	5943011101	141	5975000621*	139
4077375411	130	5943000301	137	5943011121*	141	5975000801	136
4077484611	130	5943000321*	137	5961000101	137	5975000811*	136
4077485111	130	5943000501	139	5961000111*	137	5975001101	138
4277142009	130	5943000521*	139	5961000201	137	5975001121*	138
4277182009	130	5943000601	138	5961000211*	137	5975001801	139
4277182209	130	5943000621*	138	5961000221*	137	5975001821*	139
4277242009	130	5943000801	136	5961000301	137	5975001901	138
4277242409	130	5943000811*	136	5961000321*	137	5975001921*	138
4277282009	130	5943001001	140	5961000501	139	5975002101	136
4277282509	130	5943001021*	140	5961000521*	139	5975002111*	136
4277352509	130	5943001101	137	5961000601	138	5975004901	138
4277353509	130	5943001121*	137	5961000621*	138	5975004921*	138
4277453509	130	5943001201	140	5961001001	140	5975005101	138
5577000721	144	5943001221*	140	5961001021*	140	5975005121*	138
5577000821	144	5943001301	139	5961001101	137	5975007601	139
5577000921	144	5943001321*	139	5961001121*	137	5975007621*	139

\* Part numbers are not listed in the tables but are identified in the italic notes.

P.O. Box J, One Commercial Row, Wallkill, NY 12589-0288

**Fair-Rite Products Corp.**

Phone: (888) FAIR RITE / (845) 895-2055 • FAX: (888) FERRITE / (845) 895-2629 • www.fair-rite.com • E-Mail: ferrites@fair-rite.com  
(888) 324-7748 (888) 337-7483 **Note: (914) Area Code has changed to (845).**

# Numerical Index

<u>Part Number</u>	<u>Page</u>	<u>Part Number</u>	<u>Page</u>	<u>Part Number</u>	<u>Page</u>	<u>Part Number</u>	<u>Page</u>
5976000101	137	5977002111*	136	5978001721*	140	5985010211*	158
5976000111*	137	5977002701	141	5978001801	139	5985013501	158
5976000201	137	5977002721*	141	5978001821*	139	5985013521*	158
5976000211*	137	5977003801	141	5978001901	138	5985015501	158
5976000221*	137	5977003821*	141	5978001921*	138	5985015511*	158
5976000801	136	5977004901	138	5978002101	136	5985016001	158
5976000811*	136	5977004921*	138	5978002111*	136	5985016011*	158
5976002101	136	5977005101	138	5978002701	141	5985016021*	158
5976002111*	136	5977005121*	138	5978002721*	141	6575070721	156
5977000101	137	5977006401	140	5978003801	141	6575101021	156
5977000111*	137	5977006421*	140	5978003821*	141	6575131321	156
5977000201	137	5977007601	139	5978004901	138	6575171721	156
5977000211*	137	5977007621*	139	5978004921*	138	6575202021	156
5977000221*	137	5977011101	141	5978005101	138	6577070721	156
5977000301	137	5977011121*	141	5978005121*	138	6577101021	156
5977000321*	137	5978000101	137	5978006401	140	6577131321	156
5977000501	139	5978000111*	137	5978006421*	140	6577171721	156
5977000521*	139	5978000201	137	5978007601	139	6577202021	156
5977000601	138	5978000211*	137	5978007621*	139	6578070721	156
5977000621*	138	5978000221*	137	5978011101	141	6578101021	156
5977000801	136	5978000301	137	5978011121*	141	6578131321	156
5977000811*	136	5978000321*	137	5985000101	158	6578171721	156
5977001001	140	5978000501	139	5985000111*	158	6578202021	156
5977001021*	140	5978000521*	139	5985000201	158	6677201621	154
5977001101	137	5978000601	138	5985000211*	158	6677202021	154
5977001121*	137	5978000621*	138	5985000221*	158	6677262021	154
5977001201	140	5978000801	136	5985000801	158	6677262521	154
5977001221*	140	5978000811*	136	5985000811*	158	6677322021	154
5977001301	139	5978001001	140	5985001101	158	6677323021	154
5977001321*	139	5978001021*	140	5985001121*	158	6677353521	154
5977001401	139	5978001101	138	5985001301	158	6677404021	154
5977001421*	139	5978001121*	138	5985001321*	158	6678201621	154
5977001601	140	5978001201	140	5985001801	158	6678202021	154
5977001621*	140	5978001221*	140	5985001821*	158	6678262021	154
5977001701	140	5978001301	139	5985002101	158	6678262521	154
5977001721*	140	5978001321*	139	5985002111*	158	6678322021	154
5977001801	139	5978001401	140	5985004901	158	6678323021	154
5977001821*	139	5978001421*	140	5985004921*	158	6678353521	154
5977001901	138	5978001601	140	5985010101	158	6678404021	154
5977001921*	138	5978001621*	140	5985010111*	158	7177141009	133
5977002101	136	5978001701	140	5985010201	158	7177181009	133

\* Part numbers are not listed in the tables but are identified in the italic notes.

**Fair-Rite Products Corp.** P.O. Box J, One Commercial Row, Wallkill, NY 12589-0288

Phone: (888) FAIR RITE / (845) 895-2055 • FAX: (888) FERRITE / (845) 895-2629 • www.fair-rite.com • E-Mail: ferrites@fair-rite.com  
(888) 324-7748 (888) 337-7483 **Note: (914) Area Code has changed to (845).**

# Numerical Index

<u>Part Number</u>	<u>Page</u>	<u>Part Number</u>	<u>Page</u>	<u>Part Number</u>	<u>Page</u>	<u>Part Number</u>	<u>Page</u>
7177181109	133	9475020002	146	9577340002	150	9677282008*	134
7177241009	133	9477012002	146	9577390002	150	9677282009	134
7177241209	133	9477014002	148	9577440002	150	9677282506*	134
9077002002	152	9477015002	146	9577490002	150	9677282507*	134
9077024002	152	9477016002	146	9578290002	150	9677282508*	134
9077025002	152	9477017002	148	9578340002	150	9677282509	134
9077026002	152	9477019002	146	9578390002	150	9677352506*	134
9277002002	152	9477020002	146	9578440002	150	9677352507*	134
9277008002	152	9477034002	148	9578490002	150	9677352508*	134
9277010002	152	9477036002	148	9643001015	134	9677352509	134
9277012002	152	9477375002	148	9643001165	134	9677353506*	134
9277023002	152	9477500002	148	9677001015	134	9677353507*	134
9277024002	152	9477625002	148	9677001165	134	9677353508*	134
9375020002	148	9478012002	146	9677142088*	134	9677353509	134
9377020002	148	9478014002	148	9677142089	134	9677453506*	134
9377024002	148	9478015002	146	9677182088*	134	9677453507*	134
9377036002	148	9478016002	146	9677182089	134	9677453508*	134
9378020002	148	9478019002	146	9677182288*	134	9677453509	134
9378024002	148	9478017002	146	9677182289	134	9843000104	134
9378036002	148	9478020002	148	9677242088*	134	9843000108*	134
9475012002	146	9478034002	148	9677242089	134	9877000104	134
9475014002	148	9478036002	148	9677242488*	134	9877000108*	134
9475015002	148	9478375002	148	9677242489	134	9877000204	134
9475016002	146	9478500002	148	9677282006*	134	9877000208*	134
9475019002	146	9478625002	148	9677282007*	134		

\* Part numbers are not listed in the tables but are identified in the italic notes.

**P.O. Box J, One Commercial Row, Wallkill, NY 12589-0288**

**Fair-Rite Products Corp.**

Phone: (888) FAIR RITE / (845) 895-2055 • FAX: (888) FERRITE / (845) 895-2629 • www.fair-rite.com • E-Mail: ferrites@fair-rite.com  
(888) 324-7748 (888) 337-7483 **Note: (914) Area Code has changed to (845).**





---

**P.O. Box J, One Commercial Row, Wallkill, NY 12589-0288**

**Fair-Rite Products Corp.**

Phone: (888) FAIR RITE / (845) 895-2055 • FAX: (888) FERRITE / (845) 895-2629 • [www.fair-rite.com](http://www.fair-rite.com) • E-Mail: [ferrites@fair-rite.com](mailto:ferrites@fair-rite.com)  
(888) 324-7748 **Note: (914) Area Code has changed to (845).**



Компания «ЭлектроПласт» предлагает заключение долгосрочных отношений при поставках импортных электронных компонентов на взаимовыгодных условиях!

Наши преимущества:

- Оперативные поставки широкого спектра электронных компонентов отечественного и импортного производства напрямую от производителей и с крупнейших мировых складов;
- Поставка более 17-ти миллионов наименований электронных компонентов;
- Поставка сложных, дефицитных, либо снятых с производства позиций;
- Оперативные сроки поставки под заказ (от 5 рабочих дней);
- Экспресс доставка в любую точку России;
- Техническая поддержка проекта, помощь в подборе аналогов, поставка прототипов;
- Система менеджмента качества сертифицирована по Международному стандарту ISO 9001;
- Лицензия ФСБ на осуществление работ с использованием сведений, составляющих государственную тайну;
- Поставка специализированных компонентов (Xilinx, Altera, Analog Devices, Intersil, Interpoint, Microsemi, Aeroflex, Peregrine, Syfer, Eurofarad, Texas Instrument, Miteq, Cobham, E2V, MA-COM, Hittite, Mini-Circuits, General Dynamics и др.);

Помимо этого, одним из направлений компании «ЭлектроПласт» является направление «Источники питания». Мы предлагаем Вам помощь Конструкторского отдела:

- Подбор оптимального решения, техническое обоснование при выборе компонента;
- Подбор аналогов;
- Консультации по применению компонента;
- Поставка образцов и прототипов;
- Техническая поддержка проекта;
- Защита от снятия компонента с производства.



#### Как с нами связаться

**Телефон:** 8 (812) 309 58 32 (многоканальный)

**Факс:** 8 (812) 320-02-42

**Электронная почта:** [org@eplast1.ru](mailto:org@eplast1.ru)

**Адрес:** 198099, г. Санкт-Петербург, ул. Калинина, дом 2, корпус 4, литера А.