

**Product Range**



**Knobs**

- **Machined aluminum knobs:** K Series
- **Molded phenolic knobs:** P Series
- **Knob accessories**

**Main features:**

- Many different designs
- With or without indicator lines and numbers
- Supplied with set screw (anti-vibration feature)
- Shaft hole size adaptors available

**K Series, Machined Aluminum** .....page K2



**P Series, Molded Phenolic** .....page K12



**Knob Accessories** .....page K21

**K Series, Machined Aluminum**

**Features**

- Supplied with Loctite® set-screw (anti-vibration feature)
- With and without indicator line and numbers
- Shaft hole size adaptors available



**Typical performance characteristics**

Materials ..... machined aluminum  
 Set-screw ..... steel  
 Finish ..... natural aluminum, or anodizing black  
 Adapters ..... brass, with nickel finish  
 RoHS Directive 2002/95/EC ..... compliant

Product key		Typical product key				
		<b>K</b>	<b>S</b>	<b>900</b>	<b>B</b>	<b>1/4</b>
<b>Knob Material</b>						
<b>K</b>	machined aluminum					
<b>Type</b>						
<b>blank</b>	3 flute design with and without indicator line					
<b>A</b>	6 flute design with indicator line					
<b>AS</b>	6 flute design with skirt and indicator lines					
<b>B</b>	control knob with straight knurl and top line indicator					
<b>BS</b>	control knob with straight knurl and skirt					
<b>CB</b>	control knob with sawcut indicator					
<b>D</b>	diamond knurl with indicator line					
<b>E</b>	knurl grip with dot indicator					
<b>ES</b>	knurl grip with dot indicator on skirt					
<b>FS</b>	straight knurl with indicator on skirt					
<b>HF</b>	plain body with top and side sawcut indicator					
<b>LN</b>	straight knurl with top and side indicator					
<b>LNS</b>	straight knurl with indicator line on top, side and skirt					
<b>N</b>	straight knurl, with or without spinner, concentric set					
<b>NS</b>	straight knurl with arrowhead indicator on skirt					
<b>PN</b>	straight knurl with pointer and indicator line					
<b>S</b>	3 flute design with skirt and indicator line					
<b>T</b>	square serration with indicator line					
<b>U</b>	serrated diamond trim cut with dot indicator					
<b>US</b>	serrated diamond trim cut with dot indicator and skirt					
<b>Reference diameter</b>						
Series Aluminum						
<b>400</b>	<b>501</b>	<b>700</b>	<b>900</b>	<b>1251</b>		
<b>500</b>	<b>600</b>	<b>701</b>	<b>1250</b>	<b>1755</b>		
<b>Finish</b>						
<b>A</b>	natural aluminum			<b>B</b>	black	
<b>Shaft diameter</b>						
<b>1/8</b>	.126 (3.20mm)		<b>1/4</b>	.251 (6.37mm)		

Note: Product key for reference only, not all combinations are available.

Knobs

**K Series, Machined Aluminum** (Continued)

**K series**



K700B1/4

**3 flute design with and without indicator line**

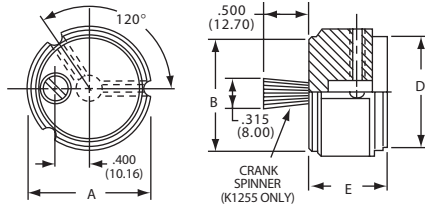

Product key	Version	Color	Dim A	Dim B	Dim D	Dim E	Part Number
K500A1/8	with indicator	natural	12.7 (.500)	10.9 (.430)	10.9 (.430)	15.9 (.625)	1437621-7
K500A1/4	indicator	natural					1437621-6
K500B1/8	line	black					1437621-9
K500B1/4		black					1437621-8
K700A1/4		natural	18.8 (.740)	16.6 (.655)	16.6 (.655)		1-1437621-0
K700B1/4		black					1-1437621-1
K900A1/4		natural	23.8 (.937)	20.8 (.817)	20.8 (.817)		1-1437621-3
K900B1/4		black					1-1437621-4
K1250A1/4		natural	31.8 (1.25)	28.2 (1.11)	28.2 (1.11)	19.1 (.750)	1437621-2
K1250B1/4		black					1437621-3
K1251B1/4	no indicator						1437621-4
K1255BS1/4	crank spinner*						1437621-5

\* with crank spinner, without indicator

**KA series**



KA500A1/4

**6 flute design with indicator line**

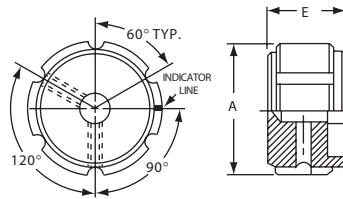

Product key	Version	Color	Dim A	Dim E	Part Number
KA500A1/8	with indicator	natural	12.7 (.500)	15.9 (.625)	2-1437621-0
KA500A1/4	indicator	natural			1-1437621-9
KA500B1/8	line	black			2-1437621-2
KA500B1/4		black			2-1437621-1
KA700A1/4		natural	19.1 (.750)		2-1437621-3
KA700B1/4		black			2-1437621-4
KA900A1/4		natural	28.8 (.937)		2-1437621-5
KA900B1/4		black			2-1437621-6
KA1250B1/4		black	31.8 (1.25)	19.1 (.750)	1-1437621-8

**KAS series**



KAS500B1/4

**6 flute design with aluminum skirt and indicator lines**

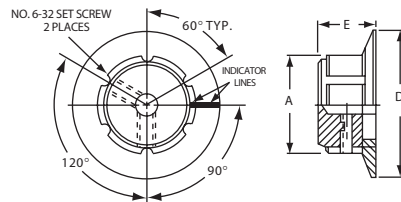

Product key	Version	Color	Dim A	Dim D	Dim E	Part Number
KAS500A1/8	with indicator	natural	12.7 (.500)	18.8 (.740)	16.0 (.630)	2-1437621-8
KAS500A1/4	aluminum	natural				2-1437621-7
KAS500B1/8	skirt	black				3-1437621-0
KAS500B1/4	and indicator	black				2-1437621-9
KAS700A1/4	lines	natural	19.1 (.750)	29.0 (1.14)		3-1437621-1
KAS700B1/4		black				3-1437621-2
KAS900A1/4		natural	23.9 (.940)	35.6 (1.40)		3-1437621-3
KAS900B1/4		black				3-1437621-4

**K Series, Machined Aluminum** (Continued)

**KB series**



**control knob with straight knurl and top line indicator**

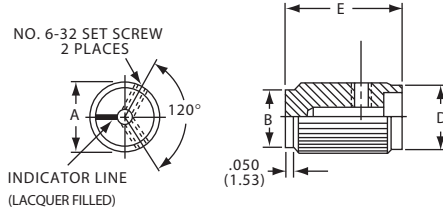

Product key	Color	Dim A	Dim B	Dim D	Dim E	Part Number
KB500A1/8	natural	12.7 (.500)	11.0 (.433)	12.0 (.472)	20.0 (.787)	3-1437621-6
KB500A1/4						3-1437621-5
KB500B1/8	black					3-1437621-9
KB500B1/4						3-1437621-8
KB700A1/4	natural	19.0 (.750)	17.1 (.673)	17.9 (.705)		4-1437621-0
KB700B1/4	black					4-1437621-2
KB900A1/4	natural	23.6 (.930)	22.0 (.866)	22.9 (.902)		4-1437621-4
KB900B1/4	black					4-1437621-5

**KBS series**



**control knob with straight knurl and skirt**

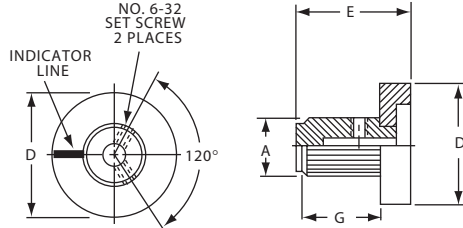

Product key	Version	Color	Dim A	Dim D	Dim E	Part Number
KBS500A101/8	with 0-9 numerals	natural	12.7 (.500)	25.4 (1.00)	24.1 (.950)	4-1437621-9
KBS500B101/8		black				5-1437621-3
KBS500B101/4		black				5-1437621-2
KBS500A1/8	with 0-9 indicator	natural				4-1437621-8
KBS500A1/4	line	natural				4-1437621-7
KBS500B1/8		black				5-1437621-1
KBS500B1/4		black				5-1437621-0

**KCB series**



**control knob with sawcut indicator**

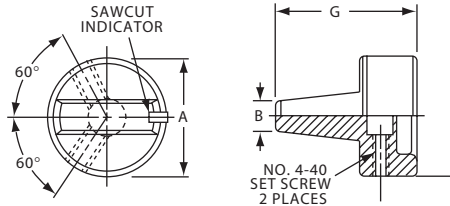

Product key	Color	Dim A	Dim B	Dim D	Dim G	Part Number
KCB500A1/8	natural	12.7 (.500)	5.08 (.197)	3.20 (.126)	19.1 (.750)	5-1437621-7
KCB500A1/4				6.40 (.252)		5-1437621-6
KCB500B1/8	black			3.20 (.126)		5-1437621-9
KCB500B1/4				6.40 (.252)		5-1437621-8
KCB600A1/8	natural	15.7 (.618)		3.20 (.126)		6-1437621-0
KCB600B1/8	black					6-1437621-2
KCB600B1/4				6.40 (.252)		6-1437621-1
KCB700A1/4	natural	18.8 (.746)		6.35 (.250)	22.8 (.898)	6-1437621-3
KCB700B1/4	black					6-1437621-4
KCB900A1/4	natural	23.8 (.937)				6-1437621-5
KCB900B1/4	black					6-1437621-7

**K Series, Machined Aluminum** (Continued)

**KD series**



KD1250B1/4

**diamond knurl with indicator line**

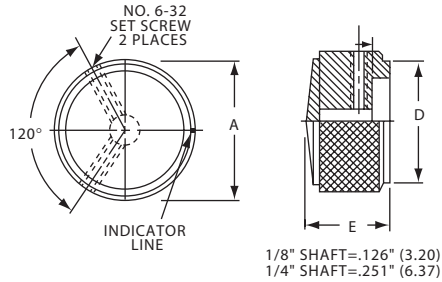

Product key	Color	Dim A	Dim D	Dim E	Part Number
KD500A1/8	natural	12.7 (.500)	10.9 (.430)	16.0 (.630)	7-1437621-1
KD500A1/4					7-1437621-0
KD500B1/8	black				7-1437621-3
KD500B1/4					7-1437621-2
KD700A1/4	natural	19.1 (.750)	16.8 (.660)		7-1437621-4
KD700B1/4	black				7-1437621-5
KD900A1/4	natural	23.9 (.940)	20.8 (.820)		7-1437621-6
KD900B1/4	black				7-1437621-7
KD1250A1/4	natural	31.8 (1.25)	28.2 (1.11)	19.1 (.750)	6-1437621-8
KD1250B1/4	black				6-1437621-9

**KE series**



KE500AB1/4

KE900AB1/4

**knurl grip with top dot indicator**

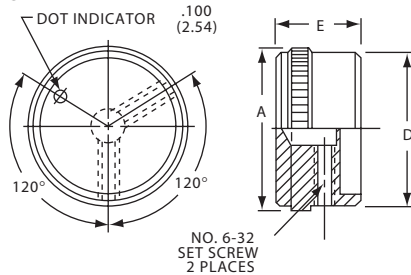

Product key	Color	Dim A	Dim D	Dim E	Part Number
KE500AB1/8	natural -	12.7 (.500)	11.7 (.460)	15.9 (.625)	8-1437621-0
KE500AB1/4	black				7-1437621-9
KE700AB1/4		18.8 (.740)	18.0 (.708)		8-1437621-1
KE900AB1/4		23.8 (.930)	22.9 (.900)		8-1437621-2
KE1250AB1/4		31.8 (1.25)	29.7 (1.17)		7-1437621-8

**KES series**



KES500AB1/4

**knurl grip with dot indicator on skirt**

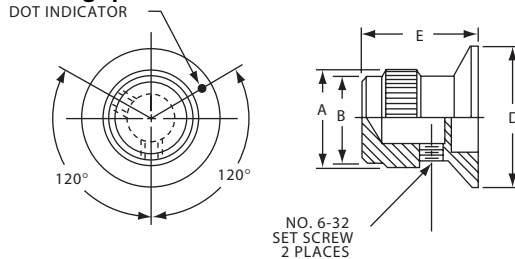

Product key	Color	Dim A	Dim B	Dim D	Dim E	Part Number
KES500AB1/8	natural -	12.7 (.500)	11.7 (.460)	19.1 (.750)	15.9 (.625)	8-1437621-4
KES500AB1/4	black					8-1437621-3
KES700AB1/4		19.1 (.750)	18.1 (.710)	28.7 (1.13)		8-1437621-5

Knobs

**K Series, Machined Aluminum** (Continued)

**KFS series**



KFS400B1/8

**straight knurl with indicator on skirt**

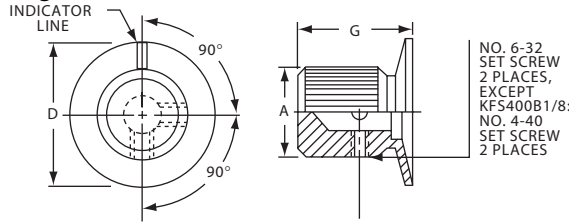

Product key	Color	Dim A	Dim D	Dim G	Part Number
KFS400B1/8	black matte	9.65 (.380)	12.7 (.500)	15.0 (.591)	8-1437621-6
KFS500B1/8		12.7 (.500)	16.0 (.630)	16.0 (.630)	8-1437621-8
KFS500B1/4		15.7 (.618)	25.4 (1.00)	20.6 (.811)	8-1437621-7
KFS600B1/4					8-1437621-9

**KHF series**



KHF500A1/4



KHF900A1/4

**plain body with top and side sawcut indicator**

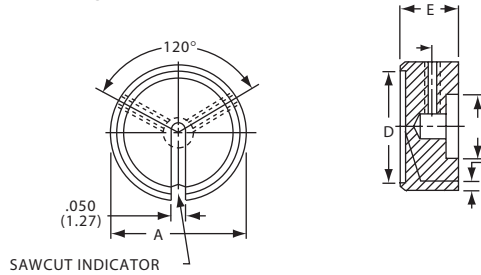

Product key	Color	Dim A	Dim E	Part Number
KHF500A1/4	natural	12.7 (.500)	14.3 (.563)	9-1437621-1
KHF700A1/4		18.8 (.740)		9-1437621-2
KHF900A1/4		23.8 (.937)		9-1437621-3
KHF1250A1/4		31.8 (1.23)		9-1437621-0

**KLN series**



KLN500A1/4

**straight knurl with top and side indicator**

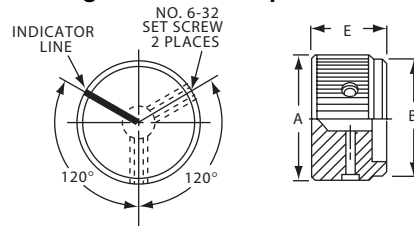

Product key	Color	Dim A	Dim B	Dim E	Part Number
KLN500A1/8	natural	12.7 (.500)	(11. (0.44)	15.9 (.625)	9-1437621-7
KLN500A1/4		12.7 (.500)	(11. (0.44)	15.9 (.625)	9-1437621-6
KLN500B1/8	black	12.7 (.500)	(11. (0.44)	15.9 (.625)	9-1437621-9
KLN500B1/4		12.7 (.500)	(11. (0.44)	15.9 (.625)	9-1437621-8
KLN500S1/4	smoke	12.7 (.500)	(11. (0.44)	15.9 (.625)	1437622-1
KLN700A1/4	natural	18.8 (.740)	17.4 (.685)	15.9 (.625)	1437622-2
KLN700B1/4	black	18.8 (.740)	17.4 (.685)	15.9 (.625)	1437622-3
KLN700B1/8		18.8 (.740)	17.4 (.685)	15.9 (.625)	1437622-4
KLN700S1/4	smoke	18.8 (.740)	17.4 (.685)	15.9 (.625)	1437622-5
KLN900A1/4	natural	23.8 (.937)	22.4 (.882)	15.9 (.625)	1437622-6
KLN900B1/4	black	23.8 (.937)	22.4 (.882)	15.9 (.625)	1437622-7
KLN900S1/4	smoke	23.8 (.937)	22.4 (.882)	15.9 (.625)	1437622-8
KLN1250A1/4	natural	31.8 (1.25)	30.3 (1.19)	15.9 (.625)	9-1437621-4
KLN1250B1/4	black	31.8 (1.25)	30.3 (1.19)	15.9 (.625)	9-1437621-5

**K Series, Machined Aluminum** (Continued)

**KLNS series**



KLNS500B/8



KLNS900B/1/4

**straight knurl with indicator line on top, side and skirt**

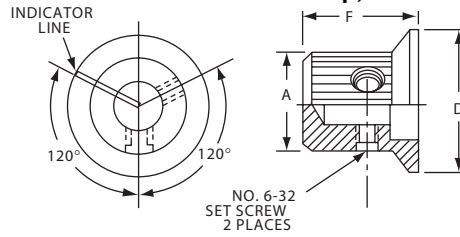

Product key	Color	Dim A	Dim D	Dim F	Part Number
KLNS500A1/8	natural	12.7 (.500)	19.0 (.750)	16.0 (.630)	1-1437622-6
KLNS500A1/4					1-1437622-5
KLNS500B1/8	black				1-1437622-8
KLNS500B1/4					1-1437622-7
KLNS700A1/4	natural	19.0 (.750)	28.7 (1.13)		2-1437622-0
KLNS700B1/4	black				2-1437622-1
KLNS900A1/4	natural	23.9 (.940)	35.5 (1.40)		2-1437622-2
KLNS900B1/4	black				2-1437622-3

**KN series**



KN501A1/4

**straight knurl with arrowhead indicator**

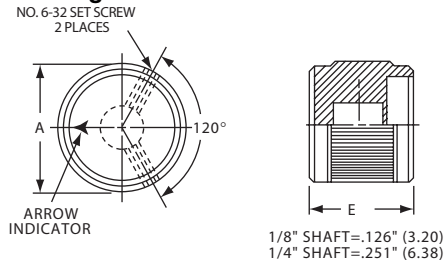

Product key	Version	Color	Dim A	Dim E	Part Number
KN501A1/8	single	natural	12.7 (.500)	15.9 (.625)	5-1437622-1
KN501A1/4	toned	natural			5-1437622-0
KN501B1/8		black			5-1437622-3
KN501B1/4					5-1437622-2
KN701A1/4		natural	19.1 (.750)		6-1437622-2
KN701B1/4		black			6-1437622-3
KN501BA1/8	two	black -	12.7 (.500)		5-1437622-5
KN501BA1/4	toned	natural			5-1437622-4
KN701BA1/8			19.1 (.750)		6-1437622-5
KN701BA1/4					6-1437622-4

**KN series**



KN1751B1/4



KN1751AS1/4

**straight knurl with and without "fingertip" spinner**

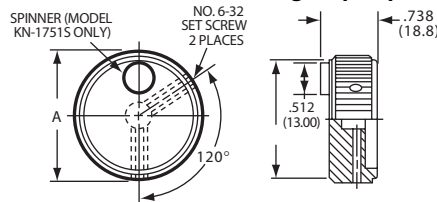

Product key	Version	Color	Dim A	Part Number
KN1751A1/4	without	natural	44.5 (1.75)	3-1437622-2
KN1751B1/4	indicator	black		3-1437622-6
KN1751AB1/4	two	ntl.-blk.		3-1437622-3
KN1751BA1/4	toned	blk.-ntl.		3-1437622-7
KN1750B1/4	with indicator	black		3-1437622-1
KN1751AS1/4	with spinner	natural		3-1437622-5
KN1751BS1/4	without indicator	black		3-1437622-8

Knobs



**K Series, Machined Aluminum** (Continued)

**KN series**



KN5700B1/4

**concentric set with straight knurl with indicator lines**

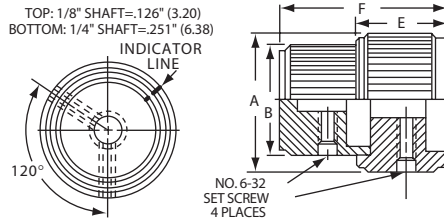

Product key	Color	Dim A	Dim B	Dim E	Dim F	Dim G	Part Number
KN5700A1/4	natural	19.1 (.750)	12.7 (.500)	15.9 (.625)	29.5 (1.16)	7.14 (.281)	5-1437622-6
KN5700B1/4	black						5-1437622-7

**KN series**



KN500A1/4



KN900BA1/4

**straight knurl with and without indicator line**

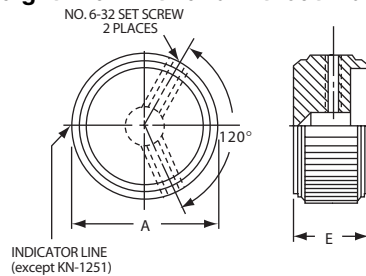

Product key	Version	Color	Dim A	Dim E	Part Number
KN500A1/8	single	natural	12.7 (.500)	15.9 (.625)	4-1437622-3
KN500A1/4	toned				4-1437622-2
KN500B1/8		black			4-1437622-7
KN500B1/4					4-1437622-6
KN700A1/4		natural	19.1 (.750)		5-1437622-8
KN700B1/4		black			6-1437622-0
KN900A1/4		natural	24.1 (.949)		6-1437622-6
KN900B1/4		black			6-1437622-8
KN1250A1/4		natural	31.8 (1.25)		2-1437622-5
KN1250B1/4		black			2-1437622-7
KN500AB1/8	two	ntl.-blk.	12.7 (.500)		4-1437622-5
KN500AB1/4	toned				4-1437622-4
KN500BA1/8		blk.-ntl.			4-1437622-9
KN500BA1/4					4-1437622-8
KN700AB1/4		ntl.-blk.	19.1 (.750)		5-1437622-9
KN700BA1/4		blk.-ntl.			6-1437622-1
KN900AB1/4		ntl.-blk.	24.1 (.949)		6-1437622-7
KN900BA1/4		blk.-ntl.			6-1437622-9
KN1250AB1/4		ntl.-blk.	31.8 (1.25)		2-1437622-6
KN1250BA1/4		blk.-ntl.			2-1437622-8
KN1251A1/4	without	natural			2-1437622-9
KN1251B1/4	indicator	black			3-1437622-0

**KN series**



**straight knurl with "crank" spinner**

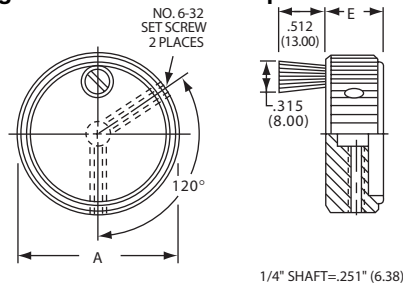

Product key	Color body/spin	Dim A	Dim E	Part Number
KN1755BS1/4	black	44.7 (1.76)	16.0 (.630)	4-1437622-1
KN1755ABS1/4	ntl.-blk./blk.			3-1437622-9
KN1755BAS1/4	blk.-ntl./blk.			4-1437622-0



**K Series, Machined Aluminum** (Continued)

**KNS series**

**straight knurl with arrowhead indicator on skirt**

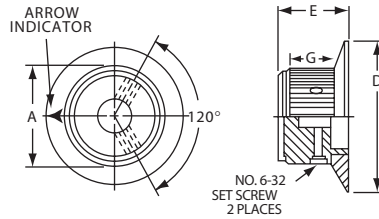

Product key	Version	Color	Dim A	Dim D	Dim E	Dim G	Part Number
KNS501A1/8	single	natural	12.7 (.500)	19.1 (.750)	15.9 (.625)	10.9 (.428)	7-1437622-3
KNS501A1/4	toned						7-1437622-2
KNS501B1/8		black					7-1437622-5
KNS501B1/4							7-1437622-4
KNS701A1/4		natural	19.1 (.750)	28.5 (1.12)			7-1437622-8
KNS701B1/4		black					7-1437622-9
KNS501BA1/8	two	blk.-ntl.	12.7 (.500)	19.1 (.750)			7-1437622-7
KNS501BA1/4	toned						7-1437622-6
KNS701BA1/8			19.1 (.750)	28.5 (1.12)			8-1437622-1
KNS701BA1/4							8-1437622-0

**KPN series**

**straight knurl with pointer and indicator line**

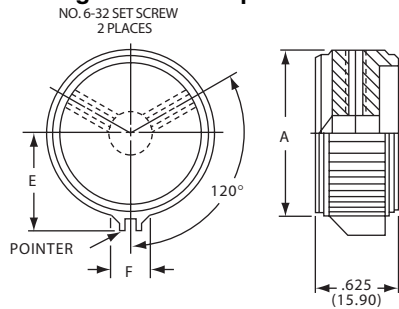

1/8" SHAFT=.126" (3.20)  
1/4" SHAFT=.251" (6.38)

Product key	Color	Dim A	Dim E	Dim F	Part Number
KPN500A1/8	natural	12.7 (.500)	9.35 (.368)	4.95 (.195)	9-1437622-1
KPN500A1/4					9-1437622-0
KPN500B1/8	black				9-1437622-3
KPN500B1/4					9-1437622-2
KPN700A1/4	natural	19.1 (.750)	13.1 (.515)	5.94 (.234)	9-1437622-5
KPN700B1/4	black				9-1437622-6
KPN900A1/4	natural	23.8 (.937)	16.0 (.630)	7.01 (.276)	9-1437622-7
KPN900B1/4	black				9-1437622-9

**K Series, Machined Aluminum** (Continued)

**KS series**

**3 flute design with aluminum skirt and indicator line**

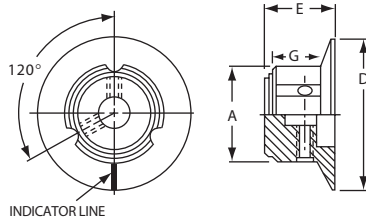

1/4" SHAFT=.251" (6.37)



Product key	Color	Dim A	Dim D	Dim E	Dim G	Part Number
KS500A1/8	natural	12.7 (.500)	19.1 (.750)	15.8 (.620)	10.9 (.430)	1437623-3
KS500A1/4	natural					1437623-2
KS500B1/8	black					1437623-5
KS500B1/4	black					1437623-4
KS700A1/4	natural	19.0 (.750)	28.4 (1.12)			1437623-6
KS700B1/4	black					1437623-7
KS900A1/4	natural	23.9 (.940)	35.6 (1.40)			1437623-8
KS900B1/4	black					1437623-9

**KT series**

**square separation with indicator line**

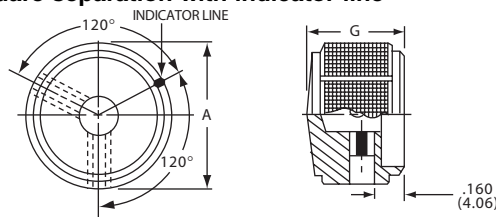

Product key	Color	Dim A	Dim G	Part Number
KT500A1/4	natural	12.7 (.500)	16.0 (.630)	1-1437623-2
KT500B1/8	black			1-1437623-4
KT500B1/4	black			1-1437623-3
KT700A1/4	natural	18.8 (.740)		1-1437623-6
KT700B1/4	black			1-1437623-7
KT900A1/4	natural	23.9 (.940)		1-1437623-8
KT900B1/4	black			1-1437623-9

**KU series**

**serrated diamond trim cut with dot indicator**

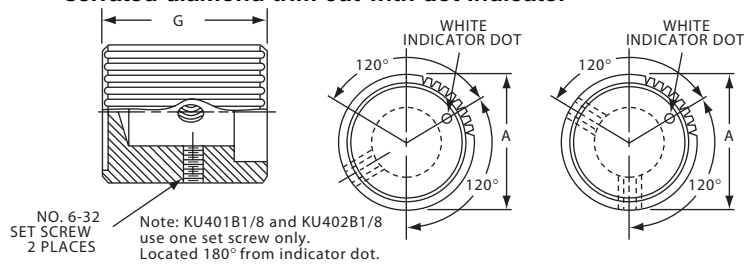

Product key	Color	Dim A	Dim G	Part Number
KU401B1/8	black	9.50 (.374)	7.60 (.299)	2-1437623-1
KU402B1/8	black		11.4 (.449)	2-1437623-2
KU500B1/8		12.7 (.500)	15.2 (.598)	2-1437623-3
KU700B1/4		18.8 (.740)		2-1437623-4

**K Series, Machined Aluminum** (Continued)

**KUS series**



**serrated diamond trim cut with dot indicator**

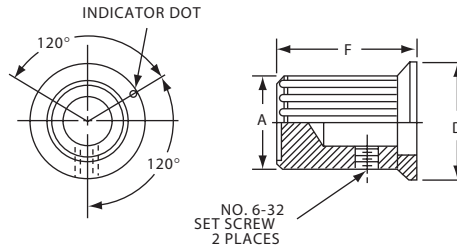

Product key	Color	Dim A	Dim D	Dim F	Part Number
KUS402B1/8	black	9.50 (.374)	13.2 (.520)	11.4 (.450)	2-1437623-9
KUS500B1/8		12.7 (.500)	17.8 (.700)	15.2 (.600)	3-1437623-0
KUS700B1/4		18.8 (.740)	26.2 (1.03)		3-1437623-1

**P Series, Molded Phenolic**

**Features**

- Supplied with Loctite® set-screw (anti-vibration feature)
- With and without indicator line and numbers
- Shaft hole size adaptors available



**Typical performance characteristics**

Material . . . . . theroset phenolic  
 Molded in bushing insert . . . . . brass  
 Set-screw . . . . . steel  
 Skirt . . . . . aluminum  
 End plate . . . . . spun aluminum  
 Finish . . . . . phenolic black  
 Adapters . . . . . brass, with nickel finish  
 RoHS Directive 2002/95/EC . . . . . compliant

Product key		Typical product key				
		<b>P</b>	<b>K</b>	<b>50</b>	<b>B</b>	<b>1/4</b>
<b>Knob Material</b>						
<b>P</b>	phenolic					
<b>Type</b>						
<b>H</b>	straight knurl without indicator line					
<b>K</b>	straight knurl with dot indicator on skirt or on top					
<b>KA</b>	ribbed with line indicator on skirt					
<b>KAP</b>	ribbed with skirt and pointer with indicator line					
<b>KB</b>	fluted with indicator line on skirt					
<b>KD</b>	straight knurl with skirt and error indicator or numerals					
<b>KDT</b>	black spin cap with "diamond cut" and arrow indicator or numerals					
<b>KE</b>	fluted with indicator line					
<b>KES</b>	fluted with skirt and indicator line					
<b>KF</b>	plain quadrate with indicator line and arrow					
<b>KG</b>	ribbed with indicator line					
<b>KGP</b>	ribbed with bar pointers and indicator line					
<b>KJ</b>	straight knurl with bar pointers and indicator line					
<b>KJT</b>	straight knurl with bar pointer and indicator line and aluminum spin cap					
<b>KN</b>	line indicator on natural aluminum spin cap					
<b>KNT</b>	black spin cap with "diamond cut" without indicator					
<b>KS</b>	straight knurl with indicator line or numerals on skirt					
<b>KX</b>	ribbed body, matte finish with square indicator on top					
<b>Reference diameter</b>						
Series Phenolic						
<b>50</b>	<b>90</b>	<b>130</b>	<b>1103</b>	<b>1132</b>		
<b>55</b>	<b>100</b>	<b>140</b>	<b>1104</b>	<b>1255</b>		
<b>60</b>	<b>110</b>	<b>150</b>	<b>1105</b>			
<b>70</b>	<b>120</b>	<b>1100</b>	<b>1106</b>			
<b>Finish</b>						
<b>A</b>	<b>B</b>	<b>black</b>				
<b>Shaft diameter</b>						
<b>1/8</b>	.126 (3.20mm)	<b>1/4</b>	.251 (6.37mm)			

Note: Product key for reference only, not all combinations are available.

Knobs

**P Series, Molded Phenolic** (Continued)

**PH series**

**straight knurl without indicator line**



PH15181/4

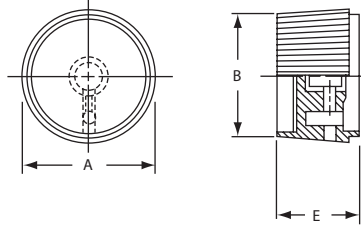

Product key	Dim A	Dim B	Dim E	Part Number
PH15181/4	25.3 (.996)	24.7 (.972)	17.0 (.669)	1437624-2

**PK series**

**straight knurl with dot indicator on skirt**



PK50B1/8

PK70B1/4

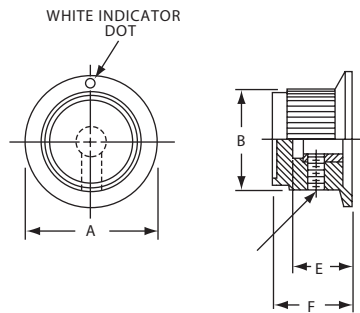

Product key	Dim A	Dim B	Dim E	Dim F	Part Number
PK50B1/8	19.0 (.748)	14.5 (.570)	11.7 (.460)	13.9 (.550)	1437624-7
PK50B1/4					1437624-6
PK70B1/4	25.0 (.984)	18.5 (.728)	12.7 (.500)	14.9 (.590)	1437624-8
PK90B1/4	31.8 (1.25)	25.0 (.985)	11.9 (.470)	15.1 (.595)	1437624-9

**PK series**

**straight knurl with dot indicator on top**



PK1100B1/4

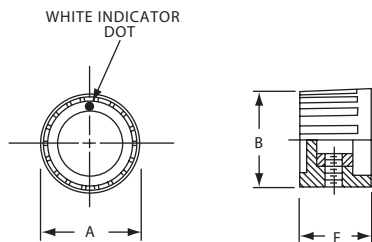

Product key	Version	Color	Dim A	Dim B	Dim F	Part Number
PK1100B1/8		natural	17.8 (.700)	16.3 (.643)	13.5 (.530)	1437624-4

**P Series, Molded Phenolic (Continued)**

**PKA series**

**ribbed with line indicator on skirt**

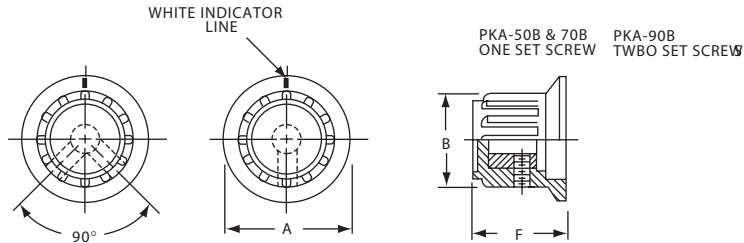

Product key	Dim A	Dim B	Dim F	Part Number
PKA50B1/8	20.2 (.795)	14.7 (.580)	15.0 (.590)	1-1437624-1
PKA50B1/4				1-1437624-0
PKA55B1/8	19.8 (.780)		17.2 (.675)	1-1437624-4
PKA55B1/4				1-1437624-3
PKA70B1/4	24.9 (.980)	18.8 (.740)	19.1 (.750)	1-1437624-5
PKA90B1/4	34.9 (1.375)	24.6 (.970)	21.3 (.840)	1-1437624-7

**PKAP series**

**ribbed with skirt and pointer with indicator line**

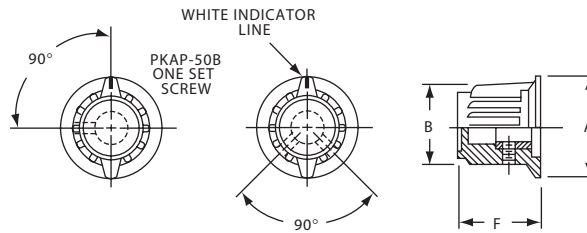

Product key	Dim A	Dim B	Dim F	Part Number
PKAP50B1/4	20.0 (.787)	17.6 (.693)	17.5 (.689)	1-1437624-8
PKAP50B1/8				1-1437624-9
PKAP70B1/4	24.8 (.976)	22.1 (.874)	18.7 (.737)	2-1437624-0

**PKB series**

**fluted with indicator line on skirt**

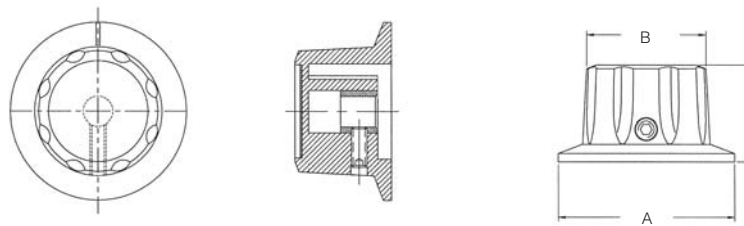

Product key	Dim A	Dim B	Dim F	Part Number
PKB70B1/4	28.3 (1.12)	19.1 (.750)	15.2 (.600)	2-1437624-3
PKB90B1/4	38.1 (1.50)	25.8 (1.02)	20.8 (.820)	2-1437624-4

**P Series, Molded Phenolic** (Continued)

**PKD series**

**straight knurl, aluminum skirt with arrow indicator or numerals**

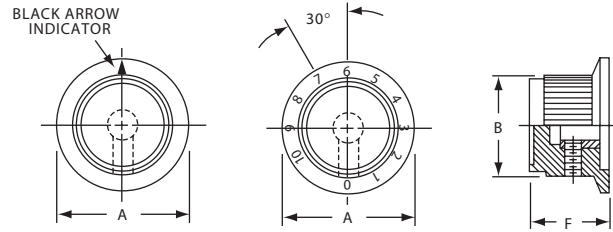

Product key	Version	Dim A	Dim B	Dim F	Part Number
PKD60B1/8	with	19.8 (.780)	14.4 (.566)	14.3 (.563)	2-1437624-8
PKD60B1/4	arrow				2-1437624-7
PKD70B1/4	indicator	25.9 (1.02)	19.1 (.750)	15.5 (.610)	3-1437624-1
PKD100B1/4		32.8 (1.29)	25.4 (1.00)	15.0 (.590)	2-1437624-5
PKD60B101/8	with	19.8 (.780)	14.4 (.566)	14.3 (.563)	3-1437624-0
PKD60B101/4	0 - 10				2-1437624-9
PKD70B101/4	numerals	25.9 (1.02)	19.1 (.750)	15.5 (.610)	3-1437624-2
PKD100B101/4		32.8 (1.29)	25.4 (1.00)	15.0 (.590)	2-1437624-6

**PKDT series**

**black spin cap with "diamond cut" and arrow indicator or numerals**

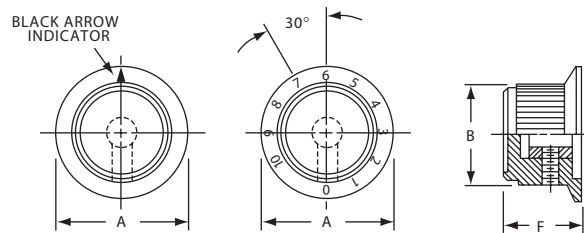

Product key	Version	Dim A	Dim B	Dim F	Part Number
PKDT70B1/4	arrow	26.0 (1.03)	18.8 (.738)	16.1 (.635)	3-1437624-9
PKDT100B1/4	indicator	32.8 (1.29)	25.9 (1.02)	16.2 (.638)	3-1437624-3
PKDT60B101/8	0 - 10	19.8 (.778)	15.4 (.605)	14.3 (.562)	3-1437624-8
PKDT70B101/4	numerals	26.0 (1.03)	18.8 (.738)	16.1 (.635)	4-1437624-0
PKDT100B101/4		32.8 (1.29)	25.9 (1.02)	16.2 (.638)	3-1437624-4

**PKE series**

**fluted with indicator line**

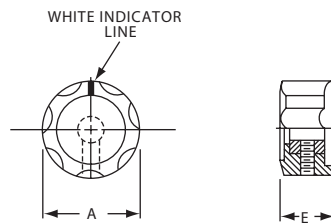

Product key	Dim A	Dim B	Dim F	Part Number
PKE60B1/8	15.9 (.626)	12.0 (.472)	16.1 (.635)	4-1437624-4
PKE60B1/4	15.9 (.626)	12.0 (.472)	16.2 (.638)	4-1437624-3
PKE90B1/4	22.6 (.890)	18.4 (.724)	14.3 (.562)	4-1437624-5



**P Series, Molded Phenolic** (Continued)

**PKES series**



**fluted with skirt and indicator line**

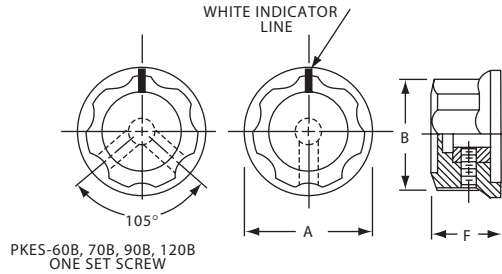

Product key	Dim A	Dim B	Dim F	Part Number
PKES60B1/8	19.0 (.748)	15.7 (.618)	11.9 (.470)	5-1437624-1
PKES60B1/4				5-1437624-0
PKES70B1/4	21.7 (.855)	18.9 (.744)	13.4 (.526)	5-1437624-2
PKES90B1/4	25.7 (1.01)	22.6 (.889)	14.5 (.570)	5-1437624-3
PKES120B1/4	32.9 (1.30)	29.5 (1.16)	16.0 (.628)	4-1437624-6
PKES140B1/4	38.1 (1.50)	34.9 (1.37)	17.6 (.693)	4-1437624-7
PKES150B1/4	44.9 (1.77)	39.4 (1.55)	21.1 (.831)	4-1437624-8

**PKF series**



**plain quadrate with indicator line and arrow**

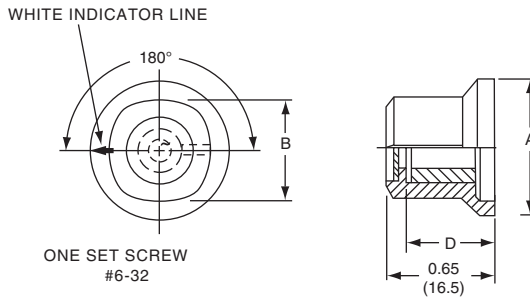

Product key	Dim A	Dim B	Dim D	Part Number
PKF50B1/8	17.0 (.670)	11.5 (.454)	13.2 (.520)	5-1437624-5

**PKG series**



**ribbed with indicator line**

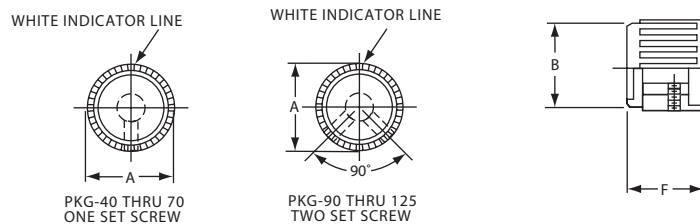

Product key	Dim A	Dim B	Dim F	Part Number
PKG40B1/8	11.1 (.437)	10.4 (.410)	12.0 (.472)	5-1437624-9
PKG50B1/8	14.0 (.551)	12.7 (.500)	13.0 (.512)	6-1437624-1
PKG50B1/4				6-1437624-0
PKG60B1/8	16.8 (.660)	15.6 (.615)	14.0 (.551)	6-1437624-6
PKG60B1/4				6-1437624-5
PKG70B1/8	18.8 (.740)	17.7 (.698)	14.2 (.559)	6-1437624-8
PKG70B1/4				6-1437624-7
PKG90B1/8	21.9 (.862)	20.6 (.811)	13.9 (.550)	7-1437624-0
PKG90B1/4				6-1437624-9
PKG100B1/4	26.8 (1.055)	25.5 (1.01)	14.1 (.555)	5-1437624-7
PKG125B1/4	31.7 (1.248)	30.4 (1.20)	14.4 (.565)	5-1437624-8

**P Series, Molded Phenolic (Continued)**

**PKGP series**

**ribbed with bar pointers and indicator line**



PKGP70B1/4

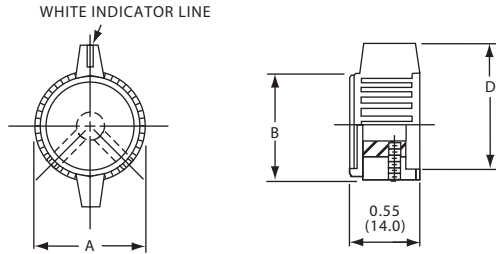

Product key	Dim A	Dim B	Dim D	Part Number
PKGP70B1/4	18.8 (.740)	17.8 (.700)	25.2 (.990)	7-1437624-2
PKGP90B1/4	21.8 (.860)	20.6 (.810)	32.5 (1.28)	7-1437624-3
PKGP100B1/4	26.2 (1.05)	25.4 (1.00)	41.2 (1.62)	7-1437624-1

**PKJ series**

**straight knurl with bar pointers and indicator line**



PKJ0B1/4

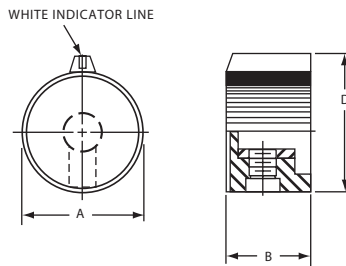

Product key	Dim A	Dim B	Dim D	Part Number
PKJ50B1/8	12.7 (.500)	13.0 (.512)	14.7 (.577)	7-1437624-5
PKJ50B1/4				7-1437624-4
PKJ60B1/4	16.0 (.630)	13.5 (.530)	19.3 (.758)	7-1437624-6
PKJ70B1/4	19.3 (.760)	14.1 (.555)	23.2 (.915)	7-1437624-7

**PKJT series**

**straight knurl with bar pointer and indicator line, aluminum spin cap**



PKJT70B1/4

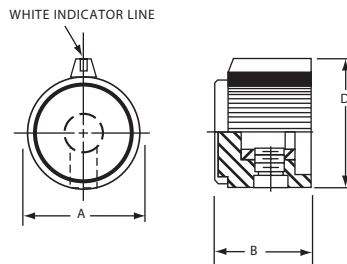

Product key	Dim A	Dim B	Dim D	Part Number
PKJT50B1/8	13.1 (.515)	14.9 (.585)	15.1 (.595)	7-1437624-9
PKJT50B1/4				7-1437624-8
PKJT60B1/4	16.3 (.640)	15.4 (.605)	19.3 (.760)	8-1437624-0
PKJT70B1/4	19.3 (.760)	15.9 (.625)	23.2 (.915)	8-1437624-1

**P Series, Molded Phenolic** (Continued)

**PKN series**

**natural aluminum spin cap with line indicator**



PKN60B1/8

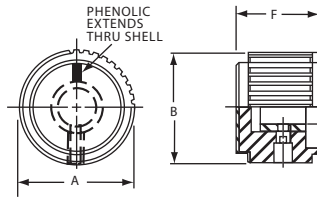

Product key	Dim A	Dim B	Dim F	Part Number
PKN60B1/8	15.0 (.591)	14.7 (.579)	11.5 (.453)	8-1437624-2
PKN60B1/4				1825009-1
PKN70B1/4	20.0 (.787)	19.4 (.764)	15.0 (.591)	8-1437624-3
PKN90B1/4	25.0 (.984)	24.3 (.957)	17.5 (.689)	8-1437624-4

**PKNT series**

**black spin cap with "diamond cut", without indicator**



PKNT60B1/4

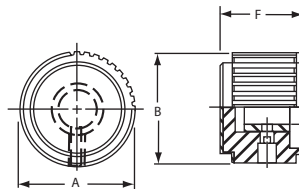

Product key	Dim A	Dim B	Dim F	Part Number
PKNT60B1/8	15.0 (.591)	14.7 (.579)	11.9 (.472)	8-1437624-6
PKNT60B1/4				8-1437624-5
PKNT70B1/4	19.9 (.787)	19.4 (.764)	14.7 (.591)	8-1437624-7
PKNT90B1/4	25.0 (.984)	24.3 (.957)	17.5 (.689)	8-1437624-8

**PKS series**

**straight knurl with aluminum skirt and arrow or 1-10 numbers**



PKS90B1/4

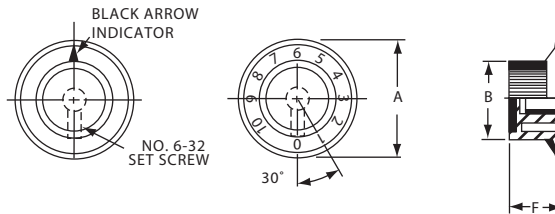

Product key	Marking	Dim A	Dim B	Dim F	Part Number
PKS90B1/4	arrow	36.1 (1.42)	23.3 (.917)	15.1 (.596)	1437625-5
PKS90B101/4	numbers				1437625-6

**PKS series**

**straight knurl with indicator line on skirt**



PKS1104B1/4

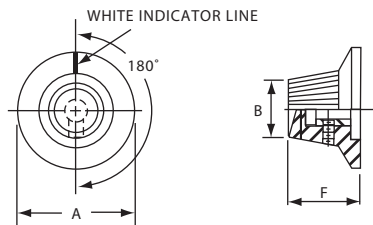

Product key	Dim A	Dim B	Dim F	Part Number
PKS1104B1/4	28.5 (1.12)	14.4 (.567)	17.0 (.670)	9-1437624-5

**P Series, Molded Phenolic (Continued)**

**PKS series**

**straight knurl aluminum skirt with line or 0-9 numbers**



PKS1106B1/4

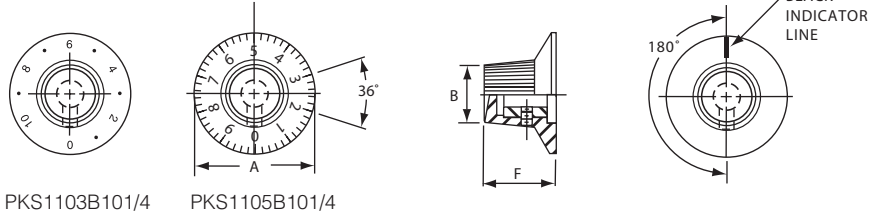

PKS1103B101/4

PKS1105B101/4

Product key	Marking	Dim A	Dim B	Dim F	Part Number
PKS1103B101/4	numbers	29.6 (1.17)	14.5 (.571)	17.0 (.670)	9-1437624-4
PKS1106B1/4	line				9-1437624-7
PKS1105B101/4	numbers				9-1437624-6

**PKS series**

**straight knurl with 0-9, 0-10, -5+5 numerals**



PKS1132B51/4

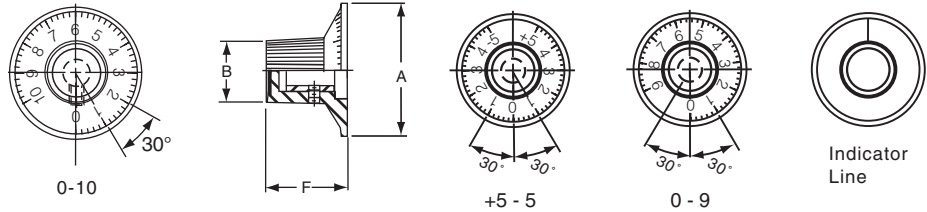

Product key	Marking	Dim A	Dim B	Dim F	Part Number
PKS1132B51/4	+5-0-5	30.0 (1.18)	14.0 (.551)	19.0 (.748)	1437625-1
PKS1132B91/4	0-9				1437625-2
PKS1132B101/4	0-10				9-1437624-9
*PKS1132B1/4	indicator line				9-1437624-8

\*) Set screw 180° from indicator line.



PKS1132B91/4

**PKX series**

**ribbed body, matte finish with square indicator on top**



PKX50B1/8

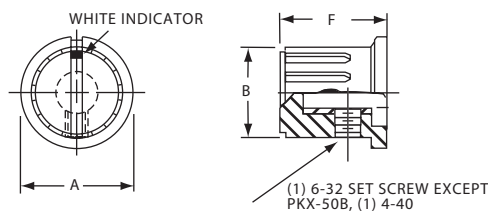

Product key	Dim A	Dim B	Dim F	Part Number
PKX50B1/8	15.0 (.590)	12.0 (.472)	14.0 (.551)	1-1437625-5
PKX50B1/4				1-1437625-4
PKX60B1/8	20.0 (.787)	15.9 (.625)	15.2 (.598)	1-1437625-7
PKX60B1/4				1-1437625-6

**P Series, Molded Phenolic** (Continued)

**PKX series**

**ribbed body, matte finish with square indicator on top**



PKX110B1/4

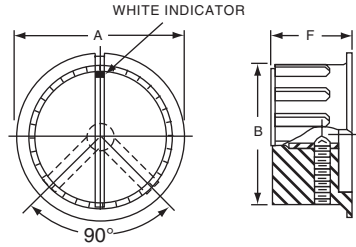

Product key	Dim A	Dim B	Dim F	Part Number
PKX100B1/4	29.7 (1.17)	24.6 (.970)	17.1 (.674)	1-1437625-1
PKX110B1/4	34.8 (1.37)	28.45 (1.120)	17.9 (.705)	1-1437625-2
PKX130B1/4	40.0 (1.57)	33.22 (1.308)	19.0 (.750)	1-1437625-3

**Knob Accessories**

**Adaptors**

**KR**

**shaft hole size adaptors for aluminum and phenolic knobs**



KR1

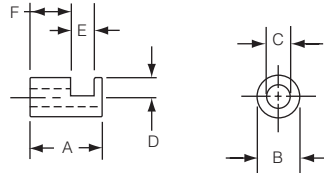

Prod. key	Version	Dim A	Dim B	Dim C	Dim D	Dim E	Dim F	Part Number
KR104	1/4" to 1/8"	9.50 (.374)	6.35 (.250)	3.25 (.128)	3.10 (.122)	5.51 (.217)	3.10 (.122)	1825620-1
KR204	1/4" to 3/16"	9.53 (.375)		4.83 (.190)		5.49 (.216)	3.12 (.123)	1825620-2
KR304	1/4" to 4mm		6.30 (.248)	4.09 (.161)				1825620-3







Компания «ЭлектроПласт» предлагает заключение долгосрочных отношений при поставках импортных электронных компонентов на взаимовыгодных условиях!

Наши преимущества:

- Оперативные поставки широкого спектра электронных компонентов отечественного и импортного производства напрямую от производителей и с крупнейших мировых складов;
- Поставка более 17-ти миллионов наименований электронных компонентов;
- Поставка сложных, дефицитных, либо снятых с производства позиций;
- Оперативные сроки поставки под заказ (от 5 рабочих дней);
- Экспресс доставка в любую точку России;
- Техническая поддержка проекта, помощь в подборе аналогов, поставка прототипов;
- Система менеджмента качества сертифицирована по Международному стандарту ISO 9001;
- Лицензия ФСБ на осуществление работ с использованием сведений, составляющих государственную тайну;
- Поставка специализированных компонентов (Xilinx, Altera, Analog Devices, Intersil, Interpoint, Microsemi, Aeroflex, Peregrine, Syfer, Eurofarad, Texas Instrument, Miteq, Cobham, E2V, MA-COM, Hittite, Mini-Circuits, General Dynamics и др.);

Помимо этого, одним из направлений компании «ЭлектроПласт» является направление «Источники питания». Мы предлагаем Вам помощь Конструкторского отдела:

- Подбор оптимального решения, техническое обоснование при выборе компонента;
- Подбор аналогов;
- Консультации по применению компонента;
- Поставка образцов и прототипов;
- Техническая поддержка проекта;
- Защита от снятия компонента с производства.



#### Как с нами связаться

**Телефон:** 8 (812) 309 58 32 (многоканальный)

**Факс:** 8 (812) 320-02-42

**Электронная почта:** [org@eplast1.ru](mailto:org@eplast1.ru)

**Адрес:** 198099, г. Санкт-Петербург, ул. Калинина, дом 2, корпус 4, литера А.