



## Low Noise Dual 220 V<sub>PP</sub> EL Driver With Output Voltage Slew Rate Control

### General Description

The MIC4833 is a low noise dual Electroluminescent (EL) Panel driver used in backlighting applications. The MIC4833 converts a low DC voltage to a high DC voltage using a boost converter and then alternates the high DC voltage across the EL panels using an H-bridge. The MIC4833 incorporates internal wave-shaping circuitry specifically designed to reduce audible noise emitted by EL panels. The two EL panels may be dimmed by applying a PWM signal to the device. The MIC4833 drives two outputs from a single inductor and requires a minimum number of passive components. It features an operating input voltage range of 2.3V to 5.8V, making it suitable for 1-cell Li-ion and 2- or 3-cell alkaline/NiCad/NiMH battery applications.

An external resistor may be used to adjust the output voltage slew rate to reduce audible noise. The MIC4833 features separate oscillators for the boost and H-bridge stages to allow independent control. External resistors set the operating frequencies of each stage allowing the EL circuit to optimize efficiency and brightness.

The MIC4833 is available in a 12 pin 3mmx3mm MLF<sup>®</sup> package, and has an operating junction temperature range of -40°C to +125°C.

### Features

- Drives two EL panels, up to 4 in<sup>2</sup> each at full brightness
- Independent input control for each of the two panels and allows PWM dimming.
- 220V<sub>pp</sub> regulated AC output waveform
- 2.3V to 5.8V DC input voltage
- Wave-shaping circuit to reduce audible noise
- Adjustable slew rate for audible noise reduction
- Independently adjustable boost converter and EL panel frequency
- Single inductor to power both panels
- 0.1uA typical shutdown current
- 12 pin 3mmx3mm MLF<sup>®</sup> package
- -40°C to +125°C junction temperature range

### Applications

- Mobile Phones
- MP3s/Portable Media Players (PMP)
- Clocks/ Watches
- Remote Controls
- Cordless Phones
- GPS Devices
- PDAs

### Typical Application

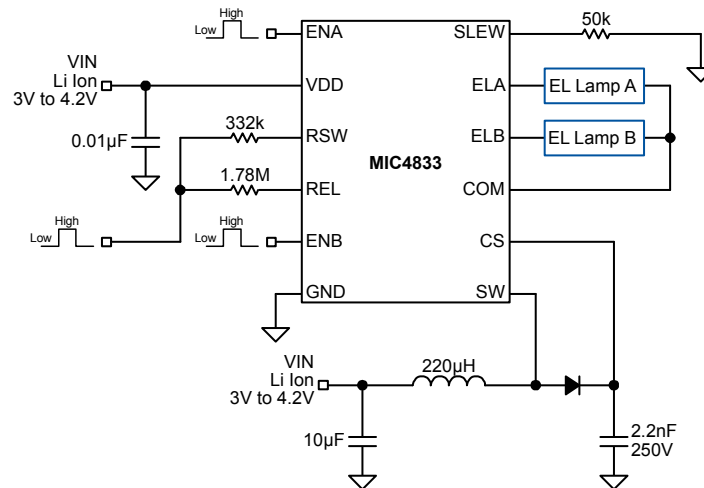

Low Noise Dual EL Driver

## Ordering Information

Part Number	Package	Operating Junction Temp Range	Lead Finish
MIC4833YML	12 pin 3mmx3mm MLF <sup>®</sup>	-40°C to +125°C	Pb-free / RoHS Compliant

## Pin Configuration

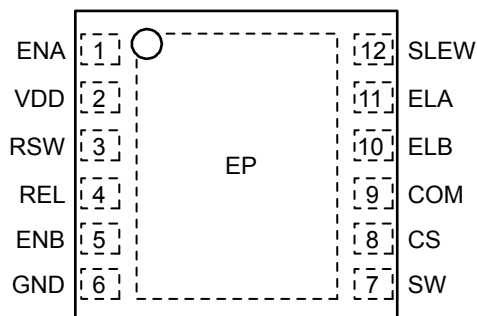

12-Pin 3mm × 3mm MLF<sup>®</sup> (ML) – Top View

## Pin Description

Pin Number	Pin Name	Pin Function
1	ENA	EL Panel A Enable Pin: Logic high enables ELA and logic low disables ELA output.
2	VDD	DC Input Supply Voltage: 2.3V to 5.8V
3	RSW	RSW pin: Sets internal boost converter switch frequency by connecting an external resistor ( $R_{SW}$ ) to VDD. Connecting the $R_{SW}$ resistor to GND shuts down the device.
4	REL	REL pin: Sets internal H-bridge driver frequency by connecting an external resistor ( $R_{EL}$ ) to VDD. Connecting the $R_{EL}$ to GND disables the EL oscillator.
5	ENB	EL Panel B enable pin: Logic high enables ELB and logic low disables ELB output.
6	GND	Ground.
7	SW	Switch Node: Drain of internal high-voltage power MOSFET for boost circuit.
8	CS	Regulated Boost Output: Connect to the output capacitor of the boost regulator and to the cathode of the diode.
9	COM	EL output: Common EL output terminal to both ELA and ELB. Connect one end of each EL panel to this pin.
10	ELB	EL Panel B output: Connect the other end of the EL panel B to this pin.
11	ELA	EL Panel A output: Connect the other end of the EL panel A to this pin.
12	SLEW	Optional resistor to set output current drive to control slew rate of load. If left open, the default slew current limit is 5mA.
EPad	HS Pad	Heat Sink Pad. Connect to ground externally.

**Absolute Maximum Rating** <sup>(1)</sup>

Supply voltage ( $V_{DD}$ )	-0.5V to 6.5V
Output voltage ( $V_{CS}$ )	-0.5V to 130V
Switch Node ( $V_{SW}$ )	-0.5V to 130V
Enable Voltage ( $V_{ENA}, V_{ENB}$ )	-0.5V to 6.5V
Voltage ( $V_{REL}, V_{RSW}, V_{SLEW}$ )	-0.5V to 6.5V
Ambient Storage Temperature ( $T_S$ )	-65°C to +150°C
ESD Rating <sup>(3)</sup>	ESD Sensitive

**Operating Range** <sup>(2)</sup>

Supply Voltage ( $V_{DD}$ )	2.3V to 5.8V
Panel Drive Frequency ( $f_{EL}$ )	100Hz to 1500Hz
Switching MOSFET Frequency ( $f_{SW}$ )	35kHz to 350kHz
Enable Voltage ( $V_{ENA}, V_{ENB}$ )	0V to $V_{DD}$
Junction Temperature Range ( $T_J$ )	-40°C to +125°C
Package Thermal Impedance	
$\theta_{JA}$ MLF <sup>®</sup> -12L	60°C/W

**Electrical Characteristics** <sup>(4)</sup>

$T_A=25^\circ\text{C}$ ,  $V_{dd} = 3.0\text{V}$  unless otherwise noted. **Bold** values indicate  $-40^\circ\text{C} \leq T_J \leq 85^\circ\text{C}$ .

Parameter	Symbol	Condition	Min	Typ	Max	Units
Supply Voltage Range	$V_{DD}$		2.3		5.8	V
Input Supply Current	$I_{DD}$	$R_{SW}=\text{High}$ ; $V_{CS}=105\text{V}$ ; ELA, ELB, COM, SLEW = Open		152	<b>220</b>	$\mu\text{A}$
Shutdown Current	$I_{SD}$	$R_{SW}=\text{Low}$ ; $V_{DD}=5.8\text{v}$		0.1	<b>1</b>	$\mu\text{A}$
On-resistance Of Switching Transistor	$R_{DS(ON)}$	$I_{SW}=100\text{mA}$ , $V_{CS}=105\text{V}$		6.0	<b>12.0</b>	$\Omega$
Output voltage Regulation	$V_{CS}$	$V_{DD}=2.3\text{V to }5.8\text{v}$	<b>90</b>	109	<b>120</b>	V
Boost Switching Frequency	$f_{SW}$	$V_{DD}=3.0\text{V}$ ( $R_{SW} = 1.3\text{M}\Omega$ )	25	35	45	kHz
		$V_{DD}=3.0\text{V}$ ( $R_{SW} = 450\text{k}\Omega$ )	75	100	125	kHz
		$V_{DD}=3.0\text{V}$ ( $R_{SW} = 125\text{k}\Omega$ )	250	350	450	kHz
ELA, ELB and COM Drive Frequency	$f_{EL}$	$V_{DD}=3.0\text{V}$ ( $R_{EL} = 1.8\text{M}\Omega$ ) ELA, ELB = Open	175	235	295	Hz
		$V_{DD}=3.0\text{V}$ ( $R_{EL} = 712\text{k}\Omega$ ) ELA, ELB = Open	445	565	685	Hz
Switching Transistor Duty Cycle	D		80		95	%
Output Current Drive Limit Programmability	$I_{SLEW}$	SLEW = Open	2.5	5	7.5	mA
		$R_{SLEW} = 10\text{k}\Omega$	7	10	13	mA
Enable Logic Threshold	$V_{ENA}, V_{ENB}$		<b>0.4</b>		<b>1.2</b>	V
Enable Logic Hysteresis	$V_{HYS}$		20	50	<b>150</b>	mV
Enable Input Current	$I_{ENA}, I_{ENB}$			0.1	1	$\mu\text{A}$

**Notes:**

- Exceeding the absolute maximum rating may damage the device.
- The device is not guaranteed to function outside its operating rating.
- Devices are ESD sensitive. Handling precautions recommended. Human body model, 1.5k $\Omega$  in series with 100pF.
- Specification for packaged product only.

## Typical Characteristics

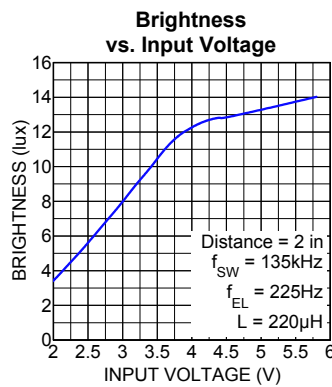
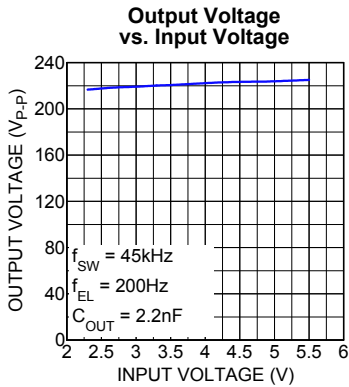
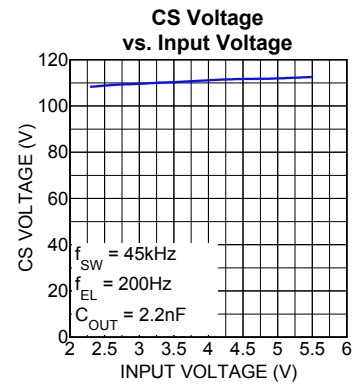
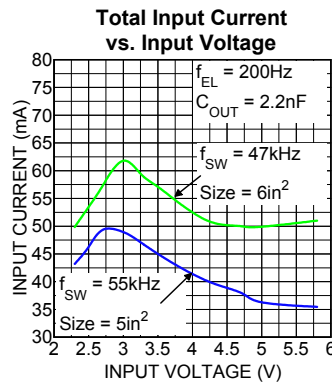
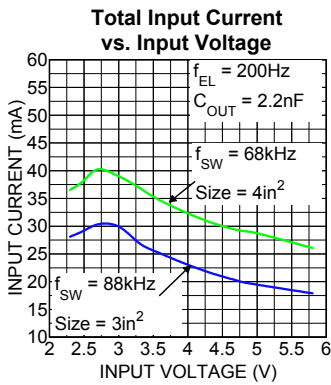
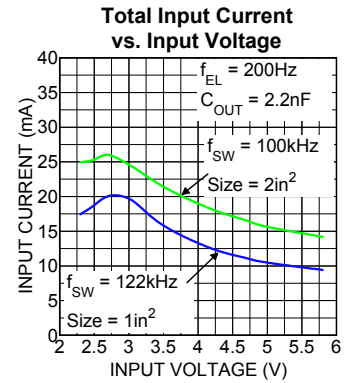
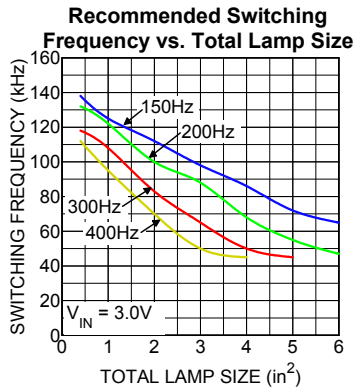
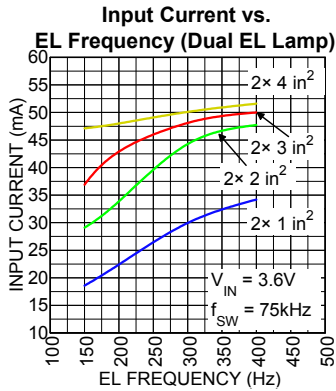
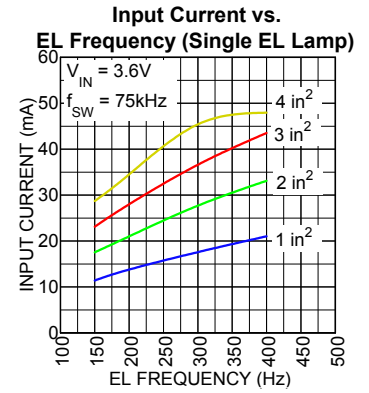
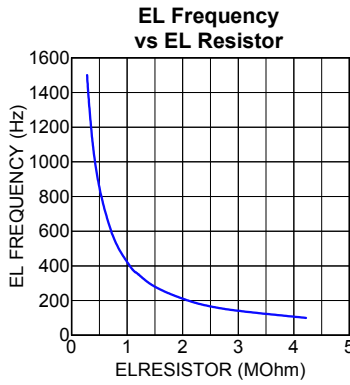
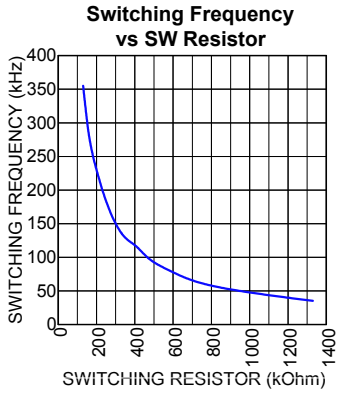

# Functional Diagram

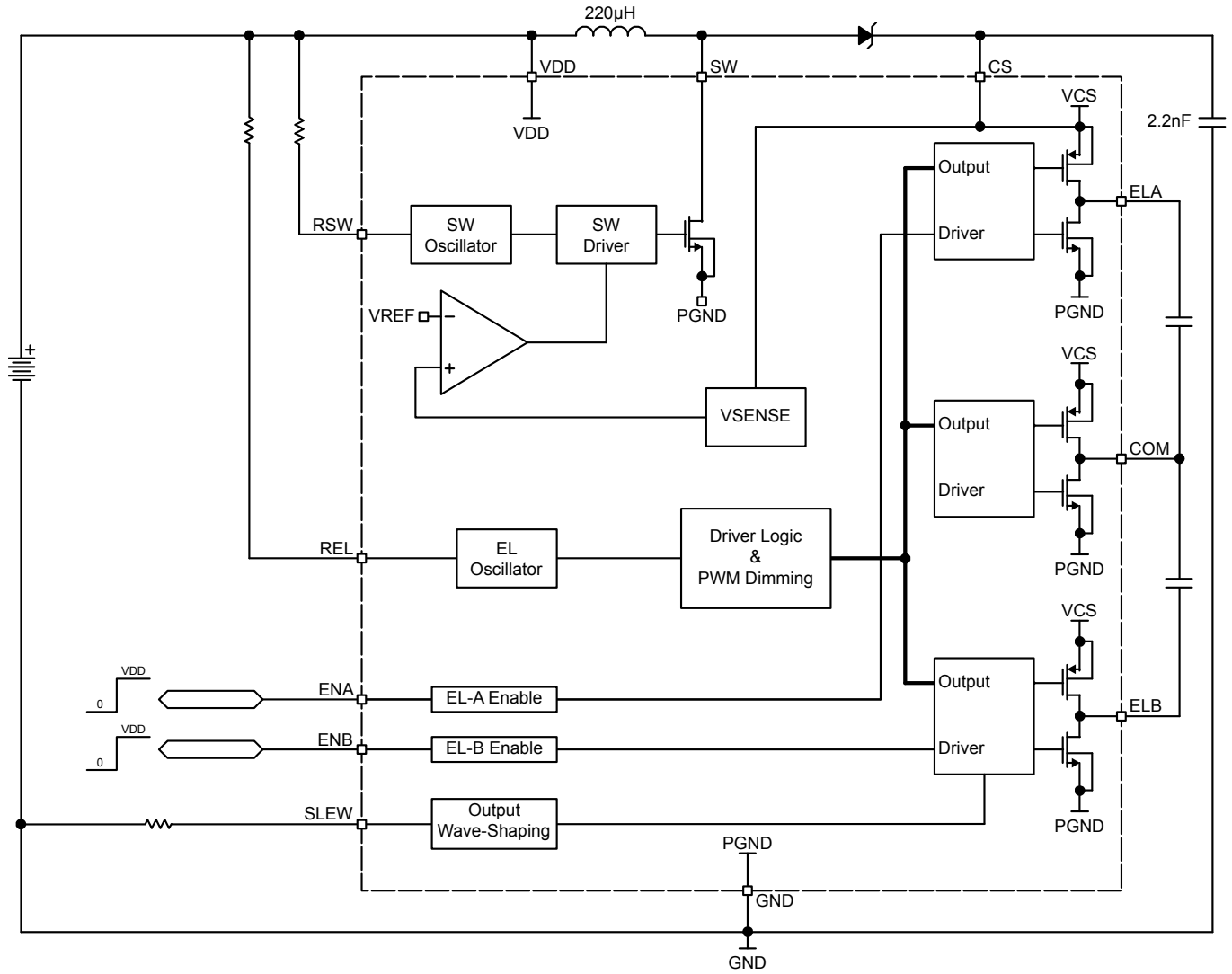

Figure 1. MIC4833 Block Diagram

## Functional Description

### Overview

The MIC4833 is a high-voltage dual output EL driver with a peak-to-peak AC output voltage of 220V capable of driving two 4 in<sup>2</sup> EL panels. The MIC4833 drives EL panels by converting a low DC input voltage to a DC high output voltage using the boost regulator circuit and then alternating the high DC voltage across the EL panel using an H-Bridge. Input supply current for the MIC4833 is typically 152μA. The high voltage EL driver has two internal oscillators to control the boost switching frequency and the H-bridge driver frequency. Both of the internal oscillators' frequencies can be individually programmed through external resistors to maximize efficiency and brightness of the EL panel. The MIC4833 can be dimmed using a PWM signal applied to the REL pin with an external capacitor. An external resistor can be used to adjust the internal wave shaping circuit to reduce audible noise.

### Regulation

Referring to Figure 1, power is initially applied to V<sub>DD</sub>. When the internal feedback voltage is less than the reference voltage, the internal comparator enables switching in the boost circuit. When the boost regulator is switching, current flows through the inductor into the switch. The switching MOSFET will typically turn on for 90% of the switching period. During the on-time, energy is stored in the inductor. When the switching MOSFET turns off, current flowing into the inductor forces the voltage across the inductor to reverse polarity. The voltage across the inductor rises until the external diode conducts and clamps the voltage at V<sub>OUT</sub> + V<sub>D1</sub>. The energy in the inductor is then discharged into the C<sub>OUT</sub> capacitor. The internal comparator continues to turn the switching MOSFET on and off until the internal feedback voltage is above the reference voltage. Once the internal feedback voltage is above the reference voltage, the internal comparator disables switching. The control circuit will continue to turn the MOSFET's on and off to maintain a constant DC voltage at the CS pin.

When the MIC4833 EL Driver is enabled, ELA and ELB will switch in opposite states with COM to achieve a 220V peak-to-peak AC output signal needed to drive the two EL panels.

### Switching Frequency

The switching frequency of the converter is controlled via an external resistor (R<sub>SW</sub>) between

RSW and VDD. The switching frequency increases as the resistor value decreases. In general, the lower the switching frequency, the greater the input current is drawn to deliver more power to the output. Lowering the switching frequency can be used to drive larger panels. However, the switching frequency should not be so low as to allow the voltage at the switch node or the CS pin to exceed the absolute maximum voltage of those pins. For resistor value selections, see the "Typical Characteristics: Switching Frequency vs. SW Resistor" graph on Page 4 or use the equation below. The switching frequency range is 35kHz to 350kHz, with an accuracy of ±20%.

$$f_{SW} \text{ (kHz)} = \frac{46}{R_{SW} \text{ (M}\Omega\text{)}}$$

### EL Frequency

The EL panel frequency is controlled via an external resistor (R<sub>EL</sub>) connected between REL and VDD. The panel frequency increases as the resistor value decreases. In general, as the EL panel frequency increases, the amount of current drawn from the battery will increase. The EL panel brightness is dependent upon its frequency. For resistor value selections, see the "Typical Characteristics: EL Frequency vs. EL Resistor" graph on Page 4 or use the equation below. The EL panel frequency range is 100Hz to 1500Hz, with an accuracy of ±20%.

$$f_{EL} \text{ (Hz)} = \frac{425}{R_{EL} \text{ (M}\Omega\text{)}}$$

### Enable Function

There are a few different ways to enable and disable the MIC4833. The boost regulator may be disabled by pulling the R<sub>SW</sub> resistor to ground. This turns off both the EL panels by cutting power to the device completely. The EL panels can also be turned off by pulling the R<sub>EL</sub> resistor to ground. Although this turns off the H-Bridge and the EL panels, the MIC4833 boost regulator will continue regulate. For individual panel control, the ENA and ENB pins can be used to enable ELA and ELB, respectively. Pulling ENA or ENB high or low will turn ELA and ELB panels on or off.

150Hz Output Waveform

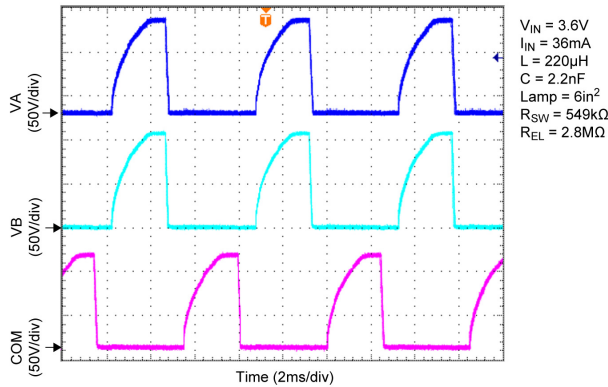

Figure 2. 150Hz Output Waveform

250Hz Output Waveform

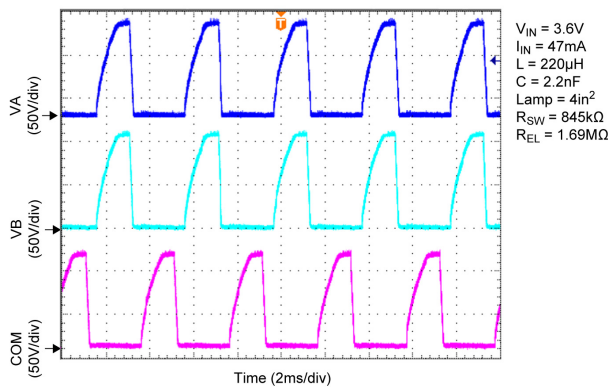

Figure 3. 250Hz Output Waveform

350Hz Output Waveform

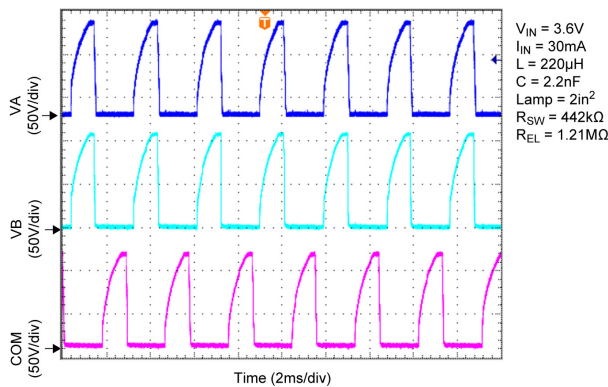

Figure 4. 350Hz Output Waveform

**PWM Dimming**

The MIC4833 may be dimmed by adding a shunt capacitor ( $C_{PWM}$ ) to the REL pin, shown in Figure 5. The duty cycle of the PWM signal changes the frequency of the EL panel, thereby changing its brightness. Increasing the PWM duty cycle increases the EL frequency to a maximum set by  $R_{EL}$  (Duty Cycle = 100%). Decreasing the PWM duty cycle decreases the EL frequency. The PWM duty cycle should not be lowered to a level that may cause the EL frequency to be lower than 100Hz, since EL frequencies lower than 100Hz may cause the panel to flicker. The frequency of the PWM signal can range from 500Hz to 50kHz. The peak voltage of the PWM signal should be equal to VDD.

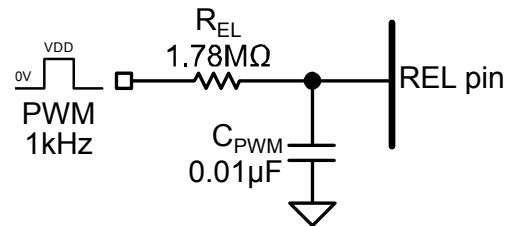

Figure 5. PWM Dimming Circuit

**Slew Resistor**

The MIC4833 is designed to reduce audible noise in EL panels by the use of the internal wave-shaping circuit. To further reduce audible noise, a Slew Resistor ( $R_{SLEW}$ ) can be added to limit the rate of change of the EL driver output voltage by limiting the output current. A slower rate of change in voltage across the EL panel creates less physical distortion in the material and therefore reduces the amount of audible noise. The lower the  $I_{SLEW}$ , the slower the output voltage across the EL panel will change. If  $R_{SLEW}$  is not used, the  $I_{SLEW}$  is by default 5mA, equivalent to using a 22kΩ for  $R_{SLEW}$ .

$R_{SLEW}$	$I_{SLEW}$
Open	5mA
125kΩ	1mA
22kΩ	5mA
10kΩ	10mA

Table 1. Slew Resistor Setting

## Application Information

The MIC4833 is designed to use an inductance with a value between 100 $\mu$ H to 330 $\mu$ H. Choosing the right inductor is always a balance of size, inductance, efficiency, current rating and cost. A TDK (VLS4012T-221M) 220 $\mu$ H inductor is recommended based on size, efficiency and current rating.

Generally, the lower the inductance, the more current the inductor can handle. Lowering the inductance allows the boost regulator to draw more input current to deliver more energy every switching cycle. As a result, a lower inductance may be used to drive larger panels or brighten similar sized panels. However, caution is required as using a low inductance with a low switching frequency may cause the voltage at the switch node and the CS pin to exceed the absolute maximum rating. If the application uses a low input voltage (2.3 to 3V), a lower value inductor, such as 100 $\mu$ H, may be used in order to drive the EL panel at maximum brightness.

### Diode

The diode must have a high reverse voltage (150V), since the output voltage at the CS pin can reach up to 130V. A fast switching diode with lower forward voltage and higher reverse voltage (150V), such as BAV20WS/BAS20W, can be used to enhance efficiency.

### Output Capacitor

Low ESR capacitors should be used at the regulated boost output (CS pin), to minimize the switching output ripple voltage. The larger the output capacitance, the lower the output ripple at the CS pin. The reduced output ripple at the CS pin along with a low ESR capacitor improves the efficiency of the MIC4833 circuit. Selection of the capacitor value depends upon the peak inductor current, inductor size, and the load. The MIC4833 is designed for use with an output capacitance as low as 2.2nF. For minimum audible noise, the use of a C0G/NPO dielectric output capacitor is recommended. TDK and AVX offer C0G/NPO dielectric capacitors in capacitances up to 2.7nF capacitance at 200V to 250V voltage rating in 0805 size.

### EL Panel Terminals (ELA, ELB, COM)

The two EL panels are connected from ELA to COM and ELB to COM. The ELA and ELB terminals are in phase with each other, while the COM is out of phase with both ELA and ELB. Since ELA and COM are out of phase, the high voltage generated by the boost regulator is alternated across ELA and COM by the H-Bridge. The frequency of each cycle is determined by  $R_{EL}$ . The alternating 220V peak-to-peak causes the EL panel to emit light. Similarly, the ELB and COM are also out of phase and allows a second EL panel to be driven at the same time. Both EL panels may operate independently from each other and do not have to be the same size. For component selection, Table 2 lists recommended values for various panel sizes up to a total of 8in<sup>2</sup> (For example, two 4in<sup>2</sup> panels). Driving overly large panels will result in a dimmer display, but will not cause damage to the device.



# Application Circuit

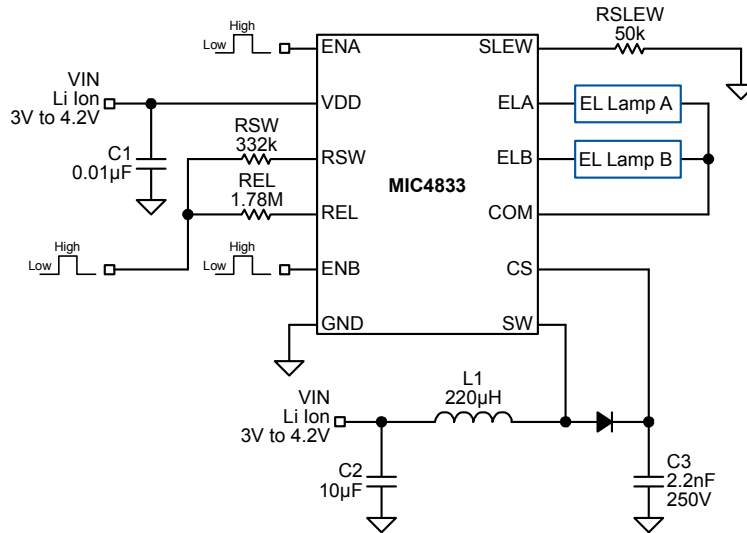

Figure 6: Typical Li-Ion Powered MIC4833 Circuit

Note: Table 2 applies to circuit shown in Figure 6.

Total Panel Area (inch <sup>2</sup> )	Capacitance (nF)	Panel Frequency (Hz)	150	200	250	300	350	400	500
		$R_{EL}$ (M $\Omega$ )	2.80	2.10	1.69	1.40	1.21	1.05	.850
0.4	2	$R_{SW}$ (k $\Omega$ )	324	340	357	383	392	402	442
		$f_{SW}$ (kHz)	138	132	126	118	116	112	102
1	5	$R_{SW}$ (k $\Omega$ )	357	365	392	422	442	475	511
		$f_{SW}$ (kHz)	125	122	116	108	102	95	88
2	10	$R_{SW}$ (k $\Omega$ )	402	453	487	549	590	649	681
		$f_{SW}$ (kHz)	112	100	92	83	76	70	66
3	15	$R_{SW}$ (k $\Omega$ )	464	511	590	698	768	909	1000
		$f_{SW}$ (kHz)	98	88	77	65	58	50	45
4	20	$R_{SW}$ (k $\Omega$ )	523	665	750	909	1000	1000	
		$f_{SW}$ (kHz)	86	68	60	50	45	45	
5	25	$R_{SW}$ (k $\Omega$ )	619	825	909	1000			
		$f_{SW}$ (kHz)	72	55	50	45			
6	30	$R_{SW}$ (k $\Omega$ )	698	953	1000				
		$f_{SW}$ (kHz)	65	47	45				
8	40	$R_{SW}$ (k $\Omega$ )	1000						
		$f_{SW}$ (kHz)	45						

Table 2: Recommended  $R_{SW}$  &  $R_{EL}$  Values For Total Panel Sizes

**Bill of Materials**

Item	Part Number	Manufacturer	Description	Qty
C1	C1608X7R1A103K	TDK <sup>(1)</sup>	0.01 $\mu$ F Ceramic Capacitor, 10V, X7R, Size 0603	1
C2	C1608X5R0J106K	TDK <sup>(1)</sup>	10 $\mu$ F Ceramic Capacitor, 6.3V, X5R, Size 0603	1
C3	C2012C0G2E2222J	TDK <sup>(1)</sup>	0.0022 $\mu$ F Ceramic Capacitor, 250V, C0G, Size 0805	1
L1	VLS4012T-221M	TDK <sup>(1)</sup>	220 $\mu$ H, 210mA I <sub>SAT</sub> . (4mmx4mmx1.2mm)	1
D1	BAS20-V-GS18	Vishay <sup>(2)</sup>	200V/200mA Hi-Voltage Switching Diode	1
R1 or R <sub>SW</sub>	CRCW06033323FKEYE3	Vishay <sup>(2)</sup>	332k $\Omega$ , 1%, 1/16W, Size 0603	1
R2 or R <sub>EL</sub>	CRCW06031784FKEYE3	Vishay <sup>(2)</sup>	1.78M $\Omega$ , 1%, 1/16W, Size 0603	1
R <sub>SLEW</sub>				Optional
<b>U1</b>	<b>MIC4833YML</b>	<b>Micrel<sup>(3)</sup></b>	<b>Low Noise Dual 220Vp-p EL Driver with Output Slew Control</b>	<b>1</b>

**Notes:**

1. TDK: [www.tdk.com](http://www.tdk.com)
2. Vishay: [www.vishay.com](http://www.vishay.com)
3. Micrel, Inc.: [www.micrel.com](http://www.micrel.com)

### Layout Recommendation

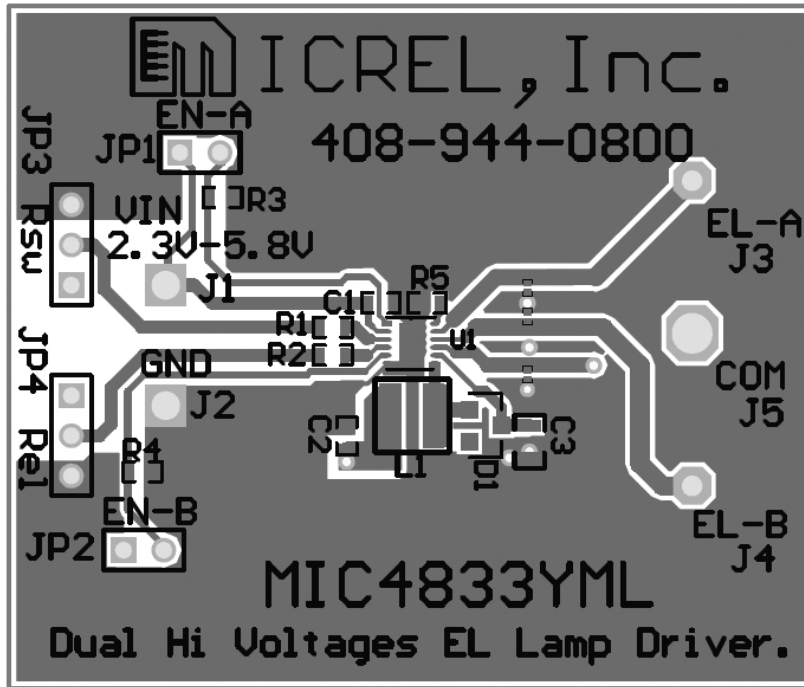

Top Layer

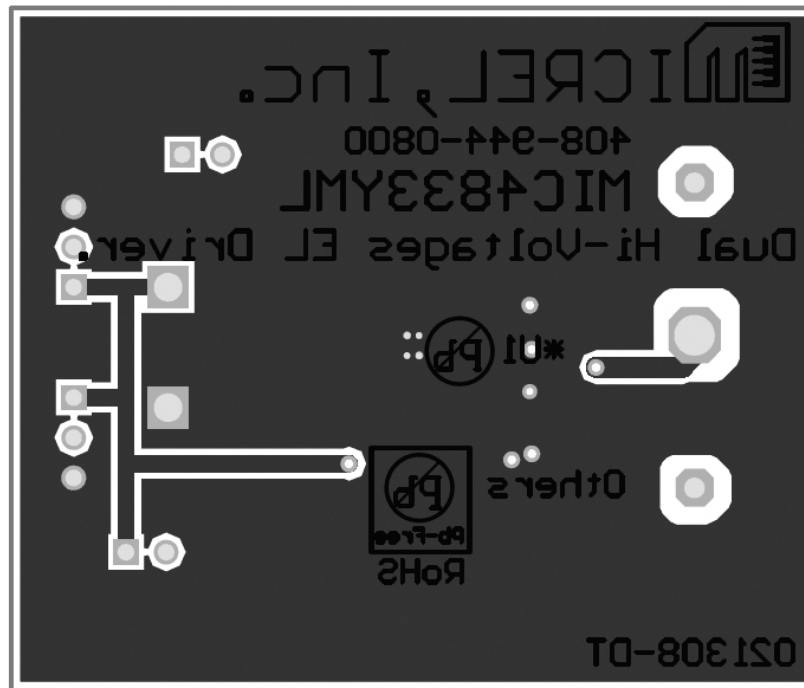

Bottom Layer

**Package Information**

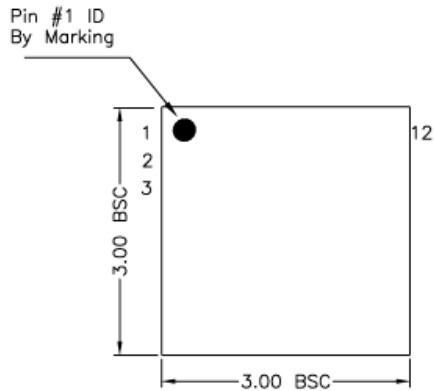

TOP VIEW

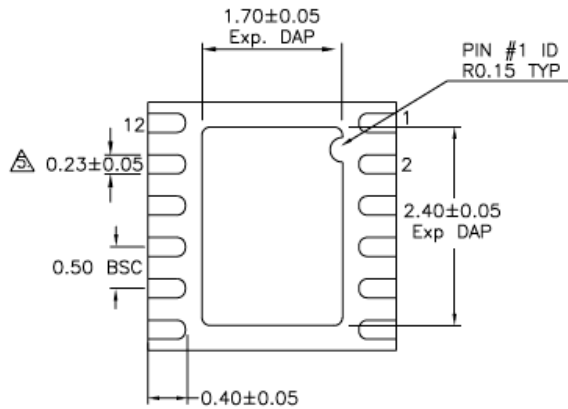

BOTTOM VIEW

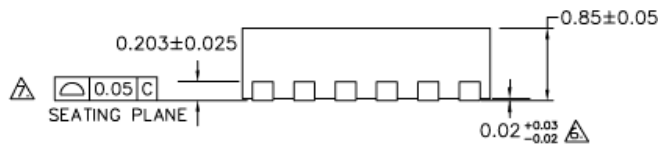

SIDE VIEW

**12-Pin 3mm x 3mm MLF<sup>®</sup> (ML)**

**MICREL, INC. 2180 FORTUNE DRIVE SAN JOSE, CA 95131 USA**  
 TEL +1 (408) 944-0800 FAX +1 (408) 474-1000 WEB <http://www.micrel.com>

The information furnished by Micrel in this data sheet is believed to be accurate and reliable. However, no responsibility is assumed by Micrel for its use. Micrel reserves the right to change circuitry and specifications at any time without notification to the customer.

Micrel Products are not designed or authorized for use as components in life support appliances, devices or systems where malfunction of a product can reasonably be expected to result in personal injury. Life support devices or systems are devices or systems that (a) are intended for surgical implant into the body or (b) support or sustain life, and whose failure to perform can be reasonably expected to result in a significant injury to the user. A Purchaser's use or sale of Micrel Products for use in life support appliances, devices or systems is a Purchaser's own risk and Purchaser agrees to fully indemnify Micrel for any damages resulting from such use or sale.

© 2008 Micrel, Incorporated.



Компания «ЭлектроПласт» предлагает заключение долгосрочных отношений при поставках импортных электронных компонентов на взаимовыгодных условиях!

Наши преимущества:

- Оперативные поставки широкого спектра электронных компонентов отечественного и импортного производства напрямую от производителей и с крупнейших мировых складов;
- Поставка более 17-ти миллионов наименований электронных компонентов;
- Поставка сложных, дефицитных, либо снятых с производства позиций;
- Оперативные сроки поставки под заказ (от 5 рабочих дней);
- Экспресс доставка в любую точку России;
- Техническая поддержка проекта, помощь в подборе аналогов, поставка прототипов;
- Система менеджмента качества сертифицирована по Международному стандарту ISO 9001;
- Лицензия ФСБ на осуществление работ с использованием сведений, составляющих государственную тайну;
- Поставка специализированных компонентов (Xilinx, Altera, Analog Devices, Intersil, Interpoint, Microsemi, Aeroflex, Peregrine, Syfer, Eurofarad, Texas Instrument, Miteq, Cobham, E2V, MA-COM, Hittite, Mini-Circuits, General Dynamics и др.);

Помимо этого, одним из направлений компании «ЭлектроПласт» является направление «Источники питания». Мы предлагаем Вам помощь Конструкторского отдела:

- Подбор оптимального решения, техническое обоснование при выборе компонента;
- Подбор аналогов;
- Консультации по применению компонента;
- Поставка образцов и прототипов;
- Техническая поддержка проекта;
- Защита от снятия компонента с производства.



#### Как с нами связаться

**Телефон:** 8 (812) 309 58 32 (многоканальный)

**Факс:** 8 (812) 320-02-42

**Электронная почта:** [org@eplast1.ru](mailto:org@eplast1.ru)

**Адрес:** 198099, г. Санкт-Петербург, ул. Калинина, дом 2, корпус 4, литера А.