

±10V, 12-Bit, Serial, Voltage-Output DAC**General Description**

The MAX5312 12-bit, serial-interface, digital-to-analog converter (DAC) provides bipolar $\pm 5V$ to $\pm 10V$ outputs from $\pm 12V$ to $\pm 15V$ power-supply voltages, or a unipolar 5V to 10V output from a single 12V to 15V power-supply voltage.

The MAX5312 features excellent linearity with both integral nonlinearity (INL) and differential nonlinearity (DNL) guaranteed to ± 1 LSB (max). The device also features a fast 10 μ s to 0.5 LSB settling time, and a hardware-shutdown feature that reduces current consumption to 3.5 μ A. The output goes to midscale at power-up in bipolar mode (0V), and to zero scale at power-up in unipolar mode (0V). A clear input (\overline{CLR}) asynchronously clears the DAC register and sets the output to 0V. The output can be asynchronously updated with the load DAC (LDAC) input.

The device features a 10MHz SPI™-/QSPI™-/MICROWIRE™-compatible serial interface that operates with 3V or 5V logic. Additional features include a serial-data output (DOUT) for daisy chaining and read-back functions. The MAX5312 requires a 2V to 5.25V external reference voltage and is available in a 16-pin SSOP package that operates over the extended -40°C to +85°C temperature range.

Applications

Motor Control
Industrial Process Controls
Industrial Automation
Automatic Test Equipment (ATE)
Analog I/O Boards
Data-Acquisition Systems

Features

- ◆ Unipolar or Bipolar Output-Voltage Ranges
Unipolar: 0 to (+2 x V_{REF}) (Single or Dual Supply)
Bipolar: (-2 x V_{REF}) to (+2 x V_{REF}) (Dual Supply)
- ◆ Guaranteed INL $\leq \pm 1$ LSB (max)
- ◆ Guaranteed Monotonic: DNL $\leq \pm 1$ LSB (max)
- ◆ 10 μ s Settling Time to 0.5 LSB
- ◆ Low 3.5 μ A Shutdown Current
- ◆ 10MHz SPI-/QSPI-/MICROWIRE-Compatible Serial Interface
- ◆ Power-On Reset Sets DAC Output to 0V
- ◆ Schmitt Trigger Inputs for Direct Optocoupler Interface
- ◆ Serial-Data Output Allows Daisy Chaining of Devices
- ◆ Small 16-Pin SSOP

Ordering Information

PART	TEMP RANGE	PIN-PACKAGE
MAX5312EAE	-40°C to +85°C	16 SSOP

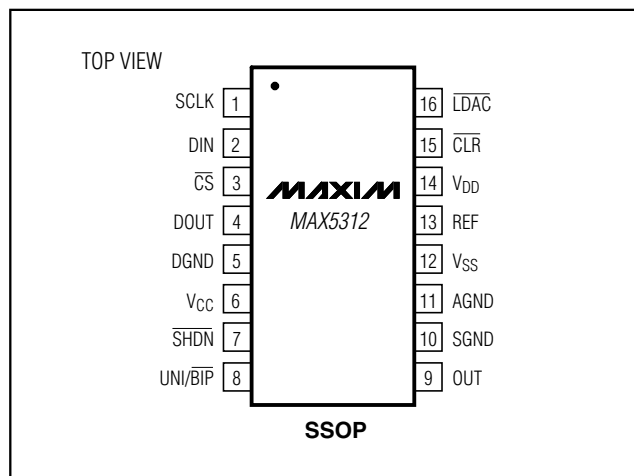
Pin Configuration

SPI and QSPI are trademarks of Motorola, Inc.
MICROWIRE is a trademark of National Semiconductor Corp.

±10V, 12-Bit, Serial, Voltage-Output DAC

ABSOLUTE MAXIMUM RATINGS

V _{DD} to AGND	-0.3V to +17V
V _{SS} to AGND	-17V to +0.3V
V _{DD} to V _{SS}	+34V
V _{CC} to DGND	-0.3V to +6V
AGND to DGND	-0.3V to +0.3V
SGND to AGND	-0.3V to +0.3V
SCLK, DIN, CS, SHDN, UNI/BIP, CLR, LDAC, DOUT to DGND	-0.3V to (V _{CC} + 0.3V)
OUT to AGND	(V _{SS} - 0.3V) to (V _{DD} + 0.3V)

REF to AGND	-0.3V to +6V
Maximum Current into REF	±10mA
Maximum Current into Any Pin Excluding REF	±50mA
Continuous Power Dissipation (T _A = +70°C)	
16-Pin SSOP (derate 7.1mW/°C above +70°C)	571mW
Operating Temperature Range	-40°C to +85°C
Junction Temperature	+150°C
Storage Temperature Range	-65°C to +150°C
Lead Temperature (soldering, 10s)	+300°C

Stresses beyond those listed under "Absolute Maximum Ratings" may cause permanent damage to the device. These are stress ratings only, and functional operation of the device at these or any other conditions beyond those indicated in the operational sections of the specifications is not implied. Exposure to absolute maximum rating conditions for extended periods may affect device reliability.

ELECTRICAL CHARACTERISTICS (DUAL SUPPLY)

(V_{DD} = +15V ±5%, V_{SS} = -15V ±5%, V_{CC} = +5V ±10%, AGND = DGND = SGND = 0V, V_{REF} = 5V, R_{LOAD} = 2kΩ, C_{LOAD} = 250pF, T_A = T_{MIN} to T_{MAX}, unless otherwise noted. Typical values are at T_A = +25°C.)

PARAMETER	SYMBOL	CONDITIONS	MIN	TYP	MAX	UNITS
STATIC ACCURACY						
Resolution	N		12			Bits
Integral Nonlinearity	INL				±1	LSB
Differential Nonlinearity	DNL	Guaranteed monotonic			±1	LSB
Zero-Scale Error		Bipolar, code = 800hex			±1	LSB
		Unipolar, code = 000hex			±2	
Zero-Scale Temperature Coefficient		Bipolar		0.3		ppm FSR/°C
		Unipolar		0.5		
Gain Error		Bipolar, no load			±2	LSB
		Unipolar, no load			±2	
Gain-Error Temperature Coefficient		Bipolar, no load		2		ppm FSR/°C
		Unipolar, no load		2		
ANALOG OUTPUT (OUT)						
Output Voltage Range		(V _{SS} + 1.5V) < V _{OUT} < (V _{DD} - 1.5V)	-2 x V _{REF}		+2 x V _{REF}	V
Resistive Load to GND	R _{LOAD}		2			kΩ
Capacitive Load to GND	C _{LOAD}				250	pF
DC Output Resistance				0.5		Ω
SGND INPUT (SGND)						
Input Impedance				92		kΩ
REFERENCE INPUT (REF)						
Reference-Voltage Input Range			2.00		5.25	V
Input Resistance	R _{REF}	Code = 555hex, worst-case code	15	22		kΩ
		Shutdown		22		
Reference Bandwidth		V _{REF} = 200mVp-p + 5VDC		200		kHz

±10V, 12-Bit, Serial, Voltage-Output DAC

MAX5312

ELECTRICAL CHARACTERISTICS (DUAL SUPPLY) (continued)

($V_{DD} = +15V \pm 5\%$, $V_{SS} = -15V \pm 5\%$, $V_{CC} = +5V \pm 10\%$, $AGND = DGND = SGND = 0V$, $V_{REF} = 5V$, $R_{LOAD} = 2k\Omega$, $C_{LOAD} = 250pF$, $T_A = T_{MIN}$ to T_{MAX} , unless otherwise noted. Typical values are at $T_A = +25^\circ C$.)

PARAMETER	SYMBOL	CONDITIONS	MIN	TYP	MAX	UNITS
DIGITAL INPUTS (SCLK, DIN, CS, SHDN, UNI/BIP, CLR, LDAC)						
Input-Voltage High	V_{IH}	$+2.7V \leq V_{CC} \leq +3.6V$	0.7 x V_{CC}			V
		$+4.5V \leq V_{CC} \leq +5.5V$	2.4			
Input-Voltage Low	V_{IL}	$+2.7V \leq V_{CC} \leq +3.6V$			0.6	V
		$+4.5V \leq V_{CC} \leq +5.5V$			0.8	
Input Capacitance	C	$+2.7V \leq V_{CC} \leq +3.6V$	10			pF
		$+4.5V \leq V_{CC} \leq +5.5V$	10			
Input Current (Note 1)		$0 \leq$ all digital inputs $\leq V_{CC}$, $+2.7V \leq V_{CC} \leq +3.6V$			± 1	μA
		$0 \leq$ all digital inputs $\leq V_{CC}$, $+4.5V \leq V_{CC} \leq +5.5V$			± 1	
DIGITAL OUTPUT (DOU)						
Output-Voltage High	V_{OH}	$I_{SOURCE} = 2mA$	$V_{CC} - 0.5$			V
Output-Voltage Low	V_{OL}	$I_{SINK} = 2mA$			0.4	V
Tri-State Leakage Current			0.2			μA
Tri-State Capacitance			10			pF
DYNAMIC PERFORMANCE						
Voltage-Output Slew Rate			2.5			V/ μs
Output Settling Time		To ± 0.5 LSB of full scale, code 000 to code FFF	10			μs
Digital Feedthrough		$\overline{CS} =$ high, $f_{SCLK} = 10MHz$, $V_{OUT} = 0V$	10			nV-s
Output-Noise Spectral Density at 10kHz			130			nV/ \sqrt{Hz}
POWER SUPPLIES						
Positive Analog-Supply Voltage	V_{DD}		10.80		15.75	V
Negative Analog-Supply Voltage	V_{SS}		-10.80		-15.75	V
Positive Digital-Supply Voltage	V_{CC}		2.7		5.5	V
Positive Analog-Supply Current	I_{DD}	Output unloaded, $V_{OUT} = FS$		1.8	4	mA
Negative Analog-Supply Current	I_{SS}	Output unloaded, $V_{OUT} = FS$		0.75	-2	mA
Digital-Supply Current	I_{CC}	All digital inputs = 0 or V_{CC}		30	200	μA
Power-Supply Rejection Ratio (Note 2)	PSRR	Positive analog supply	0.4			LSB/V
		Negative analog supply	0.6			
Shutdown Current		Positive analog supply	1.7	50		μA
		Negative analog supply	2.4	50		
		Digital supply	3.5	10		

±10V, 12-Bit, Serial, Voltage-Output DAC

ELECTRICAL CHARACTERISTICS (SINGLE SUPPLY)

($V_{DD} = +15V \pm 5\%$, $V_{SS} = 0V$, $V_{CC} = +5V \pm 10\%$, $AGND = DGND = SGND = 0V$, $V_{REF} = 5V$, $R_{LOAD} = 10k\Omega$, $C_{LOAD} = 250pF$, $T_A = T_{MIN}$ to T_{MAX} , unless otherwise noted. Typical values are at $T_A = +25^\circ C$.)

PARAMETER	SYMBOL	CONDITIONS	MIN	TYP	MAX	UNITS
STATIC ACCURACY						
Resolution	N		12			Bits
Integral Nonlinearity	INL	(Note 3)			±1	LSB
Differential Nonlinearity	DNL	Guaranteed monotonic			±1	LSB
Unipolar Zero-Scale Error		Code = 14hex			±2	LSB
Unipolar Zero-Scale Temperature Coefficient		Code = 14hex		0.05		ppm FSR/°C
Gain Error		No load			±2	LSB
Gain-Error Temperature Coefficient		No load		2		ppm FSR/°C
ANALOG OUTPUT (OUT)						
Output Voltage Range			0		+2 × V_{REF}	V
Resistive Load to GND	R_{LOAD}		10			kΩ
Capacitive Load to GND	C_{LOAD}				250	pF
DC Output Resistance				0.5		Ω
SGND INPUT (SGND)						
Input Impedance				92		kΩ
REFERENCE INPUT (REF)						
Reference-Voltage Input Range			2.00		5.25	V
Input Resistance		Code = 555hex, worst-case code	15	22		kΩ
Reference Input Bandwidth		$V_{REF} = 200mV_{P-P} + 5V_{DC}$		150		kHz
DIGITAL INPUTS (SCLK, DIN, CS, SHDN, UNI/BIP, CLR, LDAC)						
Input-Voltage High	V_{IH}	$+2.7V \leq V_{CC} \leq +3.6V$	0.7 × V_{CC}			V
		$+4.5V \leq V_{CC} \leq +5.5V$	2.4			
Input-Voltage Low	V_{IL}	$+2.7V \leq V_{CC} \leq +3.6V$	0.6			V
		$+4.5V \leq V_{CC} \leq +5.5V$	0.8			
Input Capacitance	C_{IN}	$+2.7V \leq V_{CC} \leq +3.6V$	10			pF
		$+4.5V \leq V_{CC} \leq +5.6V$	10			
Input Current	I_{IN}	$0 \leq V_{IN} \leq V_{CC}$, $+2.7V \leq V_{CC} \leq +3.6V$	±1			μA
		$0 \leq V_{IN} \leq V_{CC}$, $+4.5V \leq V_{CC} \leq +5.5V$	±1			
DIGITAL OUTPUT (DOUT)						
Output-Voltage High	V_{OH}	$I_{SOURCE} = 2mA$	$V_{CC} - 0.5$			V
Output-Voltage Low	V_{OL}	$I_{SINK} = 2mA$			0.4	V
Tri-State Leakage Current			0.2			μA

±10V, 12-Bit, Serial, Voltage-Output DAC

MAX5312

ELECTRICAL CHARACTERISTICS (SINGLE SUPPLY) (continued)

($V_{DD} = +15V \pm 5\%$, $V_{SS} = 0V$, $V_{CC} = +5V \pm 10\%$, $AGND = DGND = SGND = 0V$, $V_{REF} = 5V$, $R_{LOAD} = 10k\Omega$, $C_{LOAD} = 250pF$, $T_A = T_{MIN}$ to T_{MAX} , unless otherwise noted. Typical values are at $T_A = +25^\circ C$.)

PARAMETER	SYMBOL	CONDITIONS	MIN	TYP	MAX	UNITS
Tri-State Capacitance				10		pF
DYNAMIC PERFORMANCE						
Voltage-Output Slew Rate				2.5		V/ μ s
Output Settling Time		To ± 0.5 LSB of full scale, code 14hex to code FFF		10		μ s
Digital Feedthrough		$\overline{CS} = \text{high}$, $f_{SCLK} = 10\text{MHz}$, $V_{OUT} = 0V$		10		nV-s
Output-Noise Spectral Density at 1kHz				130		nV/\sqrt{Hz}
POWER SUPPLIES						
Positive Analog-Supply Voltage	V_{DD}		10.80		15.75	V
Negative Analog-Supply Voltage	V_{SS}			0		V
Positive Digital-Supply Voltage	V_{CC}		2.7		5.5	V
Positive Analog-Supply Current	I_{DD}	Output unloaded, $V_{OUT} = 0$		1.8	4	mA
Negative Analog-Supply Current	I_{SS}	Output unloaded, $V_{OUT} = 0$		0.75	-2	mA
Digital-Supply Current	I_{CC}	All digital inputs = 0 or V_{CC}		30	200	μ A
Power-Supply Rejection Ratio	PSRR	$\Delta V_{DD} = 14.5V$ to $15.5V$, code FFF		0.04		LSB/V
Shutdown Current		Analog supply		1.7	50	μ A
		Digital supply		3.5	10	

±10V, 12-Bit, Serial, Voltage-Output DAC

MAX5312

TIMING CHARACTERISTICS

($V_{DD} = +15V$, $V_{SS} = -15V$ or $0V$, $V_{CC} = +2.7V$ to $+5.5V$, $AGND = DGND = SGND = 0$, $V_{REF} = 5V$, $R_{LOAD} = 2k\Omega$, $C_{LOAD} = 250pF$, $T_A = T_{MIN}$ to T_{MAX} , unless otherwise noted. Typical values are at $T_A = +25^\circ C$.)

PARAMETER	SYMBOL	CONDITIONS	MIN	TYP	MAX	UNITS
SCLK Frequency					10	MHz
SCLK Clock Period	t_{CP}		100			ns
SCLK Pulse-Width High	t_{CH}	For nondaisy-chain use	45			ns
SCLK Pulse-Width Low	t_{CL}	For nondaisy-chain use	45			ns
\overline{CS} Fall to SCLK Rise Setup Time	t_{CSS}		40			ns
SCLK Rise to \overline{CS} Rise Hold Time	t_{CSH}	$+2.7V \leq V_{CC} \leq +3.6V$	15			ns
		$+4.5V \leq V_{CC} \leq +5.5V$	10			
DIN Setup Time	t_{DS}		20			ns
DIN Hold Time	t_{DH}		10			ns
\overline{LDAC} Pulse Width	t_{LD}		50			ns
\overline{CS} Rise to \overline{LDAC} Low Setup Time	t_{LDS}	$+2.7V \leq V_{CC} \leq +3.6V$		100		ns
		$+4.5V \leq V_{CC} \leq +5.5V$		50		
SCLK Fall to DOUT Valid Propagation Delay	t_{DO1}	$C_{LOAD} = 20pF$, $+2.7V \leq V_{CC} \leq +3.6V$			100	ns
		$C_{LOAD} = 20pF$, $+4.5V \leq V_{CC} \leq +5.5V$			80	
SCLK Rise to \overline{CS} Fall Delay	t_{CS0}			10		ns
\overline{CS} Low to DOUT Valid Time	t_{CSE}	$C_{LOAD} = 20pF$			120	ns
\overline{CS} High to DOUT Disabled Time	t_{CSD}				120	ns
\overline{CS} Rise to SCLK Rise Hold Time	t_{CS1}		50			ns
\overline{CS} Pulse-Width High	t_{CSW}	$+2.7V \leq V_{CC} \leq +3.6V$	200			ns
		$+4.5V \leq V_{CC} \leq +5.5V$	100			
\overline{CLR} Pulse-Width Low	t_{CLR}			50		ns

Note 1: Output unloaded, digital inputs = V_{CC} or DGND.

Note 2: $\Delta V_{DD} = +14.5V$ to $+15.5V$, $\Delta V_{SS} = -15.5V$ to $-14.5V$, code = FFF.

Note 3: Measured from code 14hex to FFFhex.

±10V, 12-Bit, Serial, Voltage-Output DAC

MAX5312

Typical Operating Characteristics

($V_{DD} = +15V$, $V_{SS} = -15V$ for bipolar graphs, $V_{SS} = 0$ for unipolar graphs, $V_{CC} = +5V$, $AGND = DGND = SGND = 0$, $V_{REF} = +5.0V$, output unloaded, $T_A = +25^\circ C$, all graphs apply to both unipolar and bipolar, unless otherwise noted.)

INTEGRAL NONLINEARITY vs. INPUT CODE

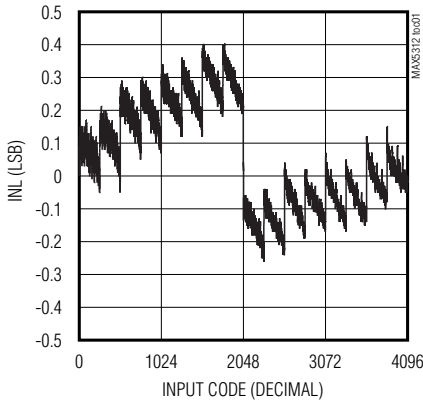

INTEGRAL NONLINEARITY vs. REFERENCE VOLTAGE

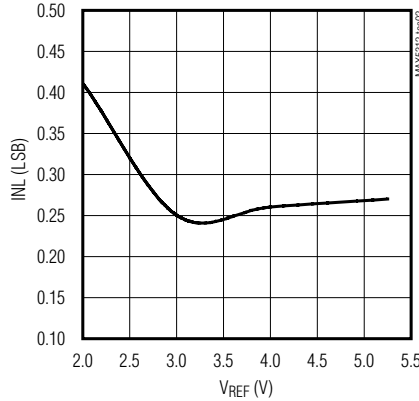

DIFFERENTIAL NONLINEARITY vs. INPUT CODE

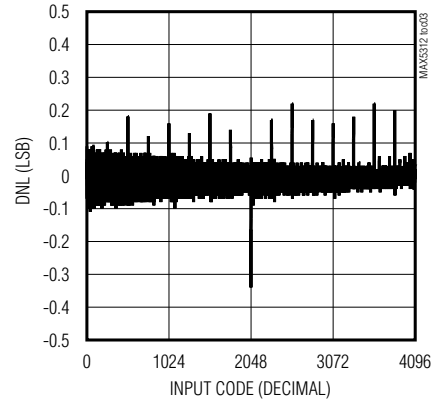

DIFFERENTIAL NONLINEARITY vs. REFERENCE VOLTAGE

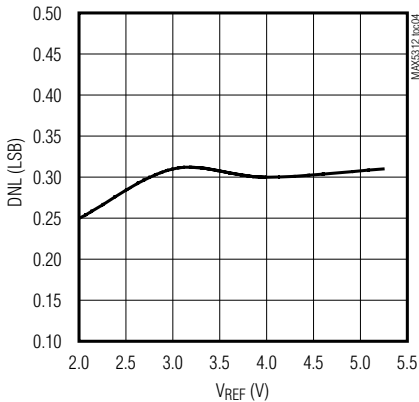

INTEGRAL NONLINEARITY vs. TEMPERATURE

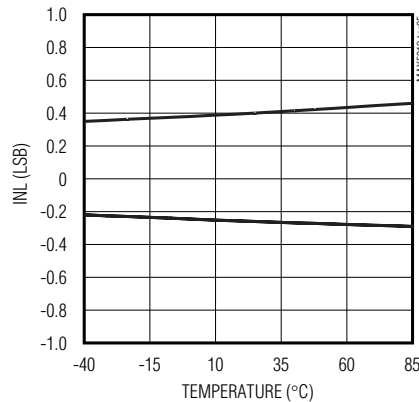

DIFFERENTIAL NONLINEARITY vs. TEMPERATURE (WORST-CASE CODES)

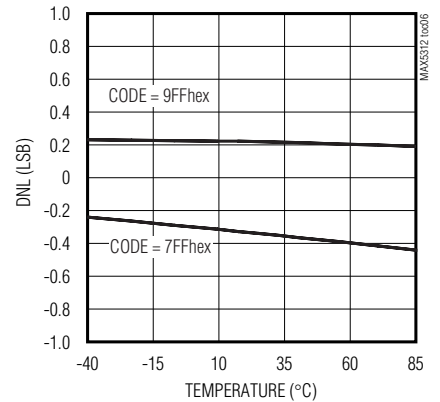

UNIPOLAR SETTLING TIME (CLOAD = 250pF, RLOAD = 2kΩ)

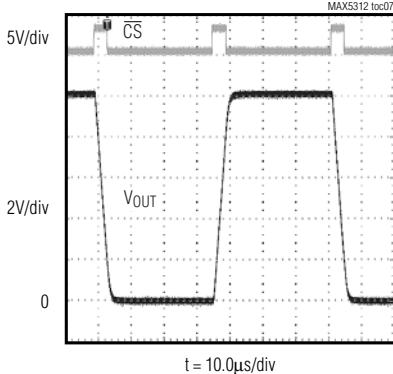

BIPOLAR SETTLING TIME (CLOAD = 250pF, RLOAD = 10kΩ)

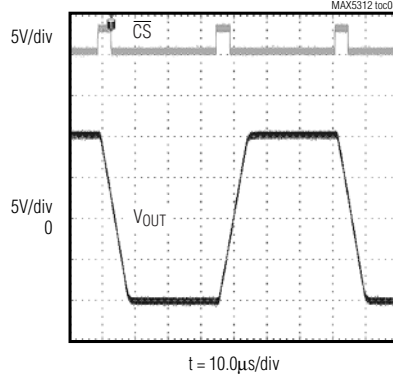

BIPOLAR MAJOR CARRY GLITCH ENERGY, CLOAD = 250pF

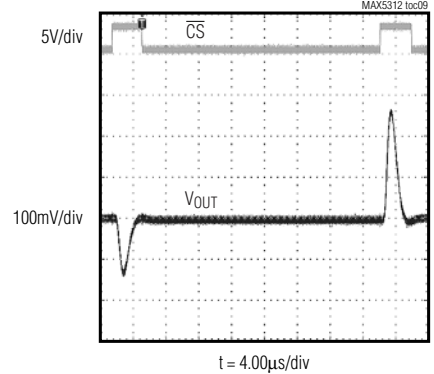

±10V, 12-Bit, Serial, Voltage-Output DAC

Typical Operating Characteristics (continued)

($V_{DD} = +15V$, $V_{SS} = -15V$ for bipolar graphs, $V_{SS} = 0$ for unipolar graphs, $V_{CC} = +5V$, $AGND = DGND = SGND = 0$, $V_{REF} = +5.0V$, output unloaded, $T_A = +25^\circ C$, all graphs apply to both unipolar and bipolar, unless otherwise noted.)

BIPOLAR MAJOR CARRY GLITCH
 $C_{LOAD} = 10pF$

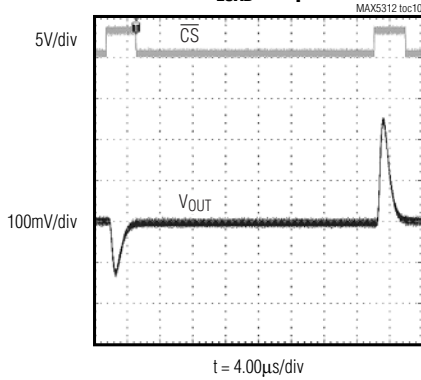

UNIPOLAR ZERO-SCALE VOLTAGE vs. TEMPERATURE

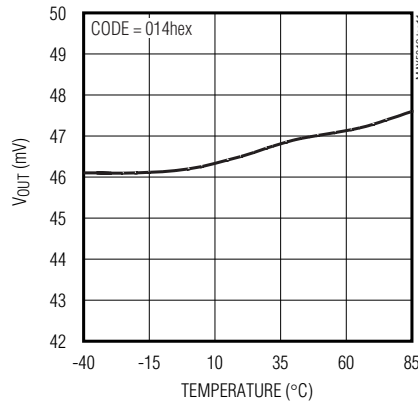

BIPOLAR MIDSCALE VOLTAGE vs. TEMPERATURE

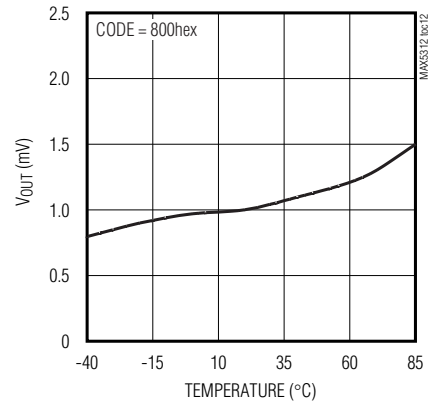

UNIPOLAR FULL-SCALE VOLTAGE vs. TEMPERATURE

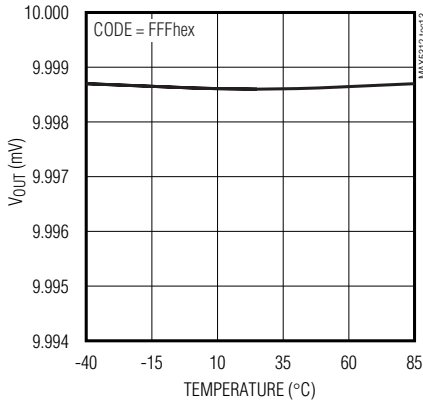

BIPOLAR POSITIVE FULL-SCALE VOLTAGE vs. TEMPERATURE

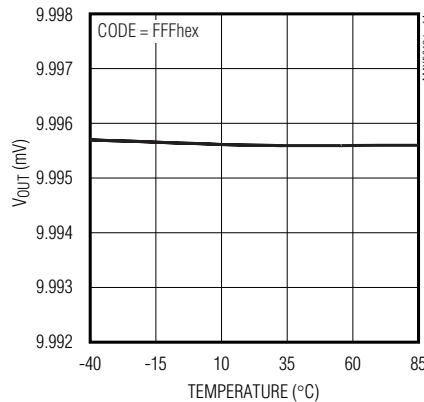

BIPOLAR NEGATIVE FULL-SCALE VOLTAGE vs. TEMPERATURE

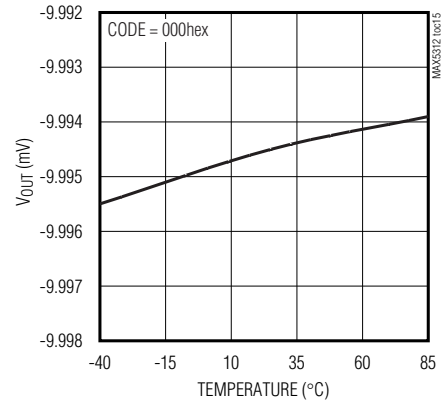

UNIPOLAR SUPPLY CURRENT vs. SUPPLY VOLTAGE

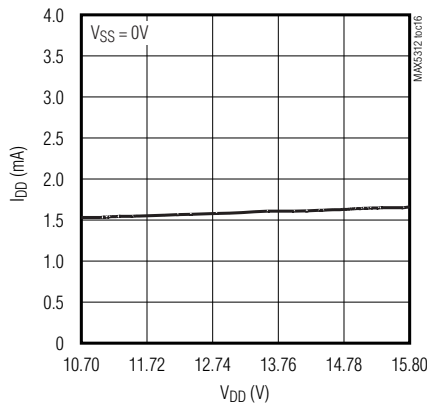

BIPOLAR POSITIVE SUPPLY CURRENT vs. SUPPLY VOLTAGE

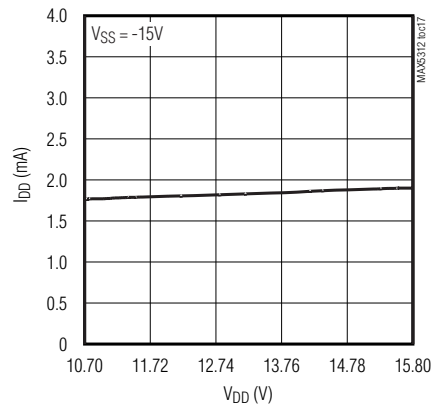

±10V, 12-Bit, Serial, Voltage-Output DAC

MAX5312

Typical Operating Characteristics (continued)

($V_{DD} = +15V$, $V_{SS} = -15V$ for bipolar graphs, $V_{SS} = 0$ for unipolar graphs, $V_{CC} = +5V$, $AGND = DGND = SGND = 0$, $V_{REF} = +5.0V$, output unloaded, $T_A = +25^\circ C$, all graphs apply to both unipolar and bipolar, unless otherwise noted.)

BIPOLAR NEGATIVE SUPPLY CURRENT vs. SUPPLY VOLTAGE

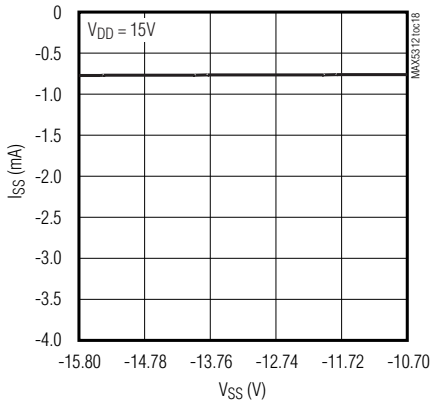

UNIPOLAR SUPPLY CURRENT vs. TEMPERATURE

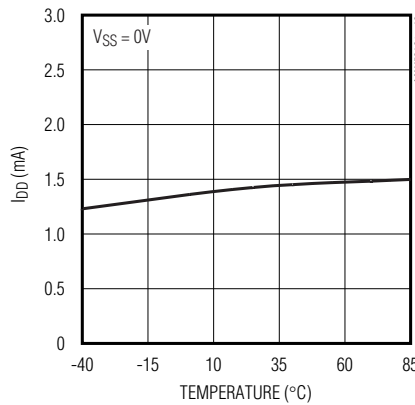

BIPOLAR POSITIVE SUPPLY CURRENT vs. TEMPERATURE

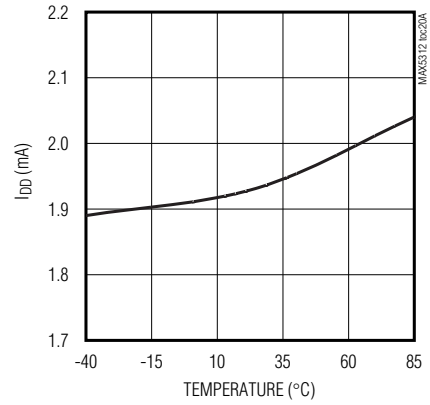

BIPOLAR NEGATIVE SUPPLY CURRENT vs. TEMPERATURE

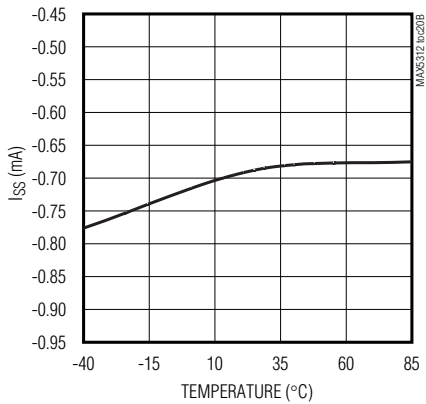

UNIPOLAR SHUTDOWN CURRENT vs. TEMPERATURE

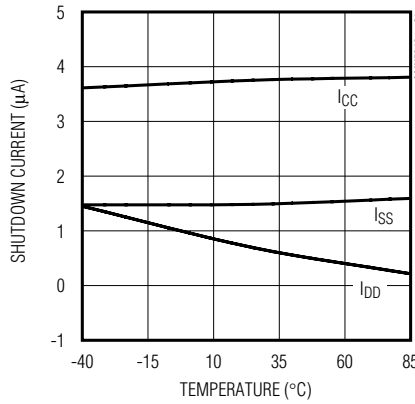

BIPOLAR SHUTDOWN CURRENT vs. TEMPERATURE

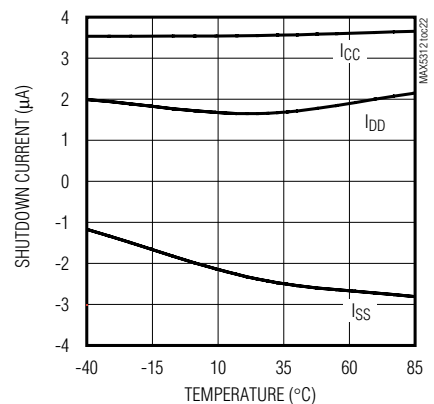

UNIPOLAR OUTPUT VOLTAGE vs. OUTPUT CURRENT

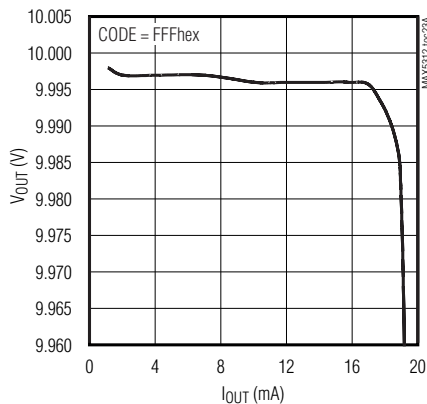

UNIPOLAR OUTPUT VOLTAGE vs. OUTPUT CURRENT

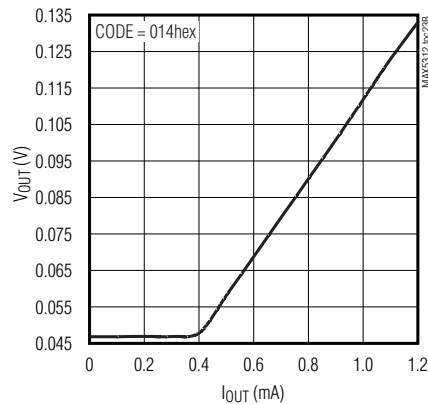

±10V, 12-Bit, Serial, Voltage-Output DAC

Typical Operating Characteristics (continued)

($V_{DD} = +15V$, $V_{SS} = -15V$ for bipolar graphs, $V_{SS} = 0$ for unipolar graphs, $V_{CC} = +5V$, $AGND = DGND = SGND = 0$, $V_{REF} = +5.0V$, output unloaded, $T_A = +25^\circ C$, all graphs apply to both unipolar and bipolar, unless otherwise noted.)

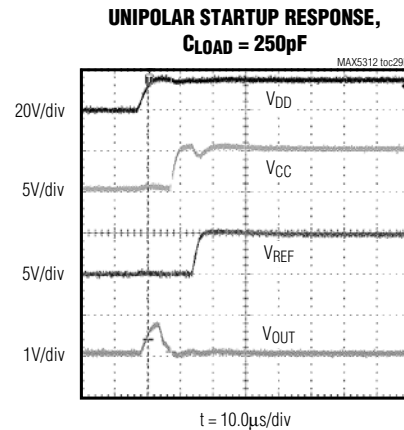
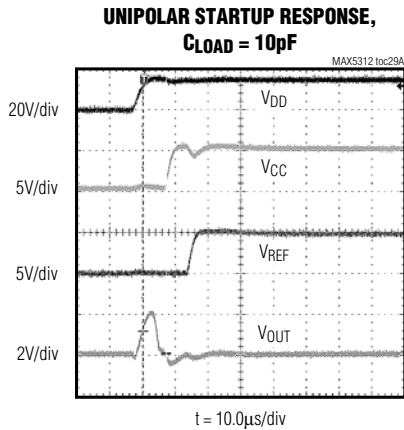
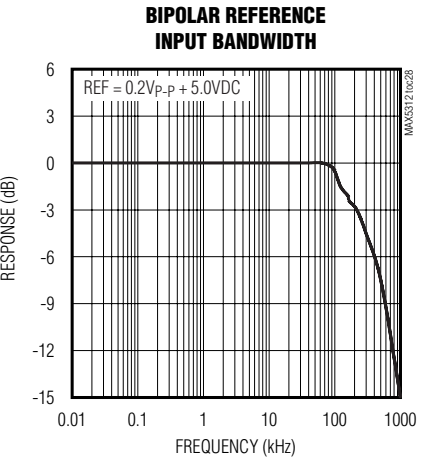
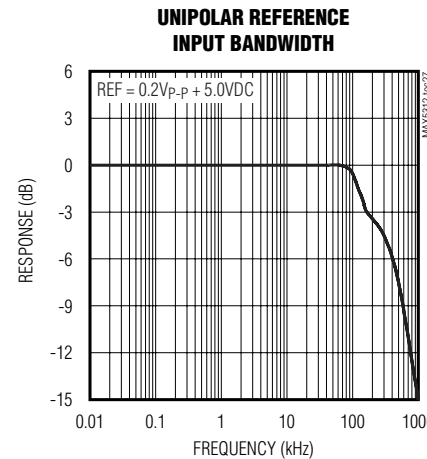
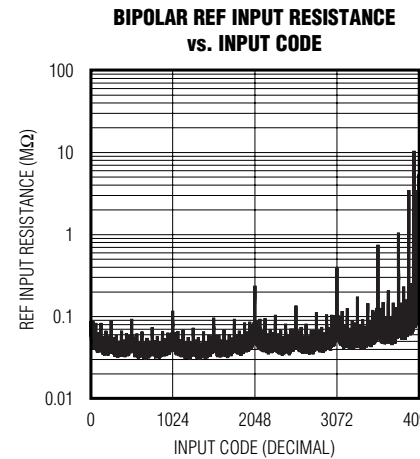
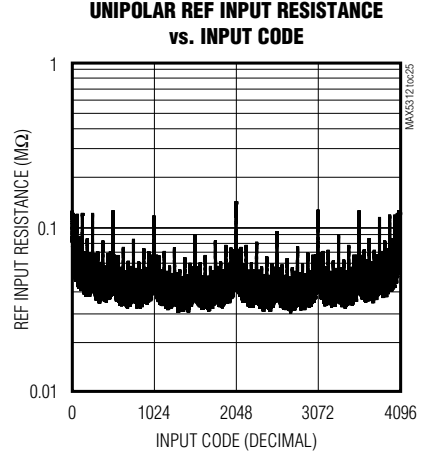
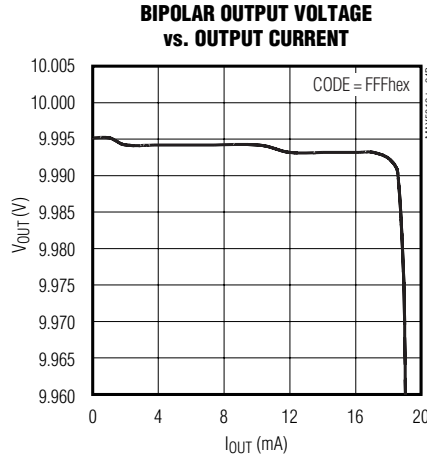
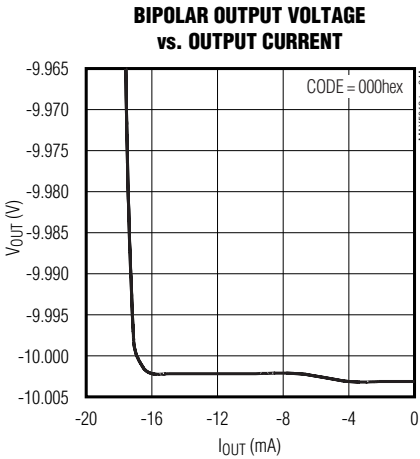

±10V, 12-Bit, Serial, Voltage-Output DAC

MAX5312

Typical Operating Characteristics (continued)

($V_{DD} = +15V$, $V_{SS} = -15V$ for bipolar graphs, $V_{SS} = 0$ for unipolar graphs, $V_{CC} = +5V$, $AGND = DGND = SGND = 0$, $V_{REF} = +5.0V$, output unloaded, $T_A = +25^\circ C$, all graphs apply to both unipolar and bipolar, unless otherwise noted.)

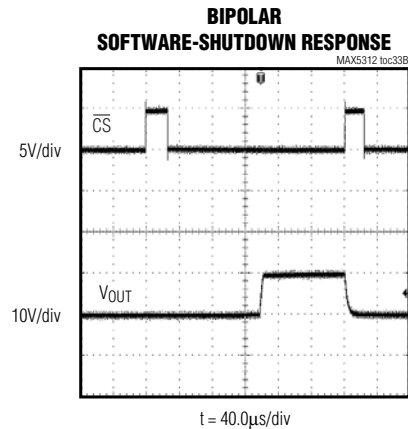
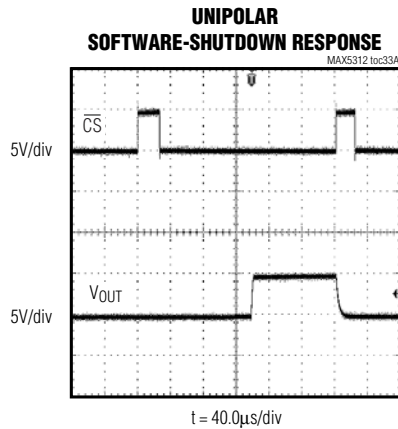
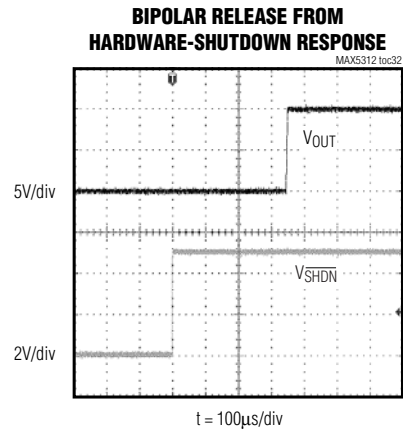
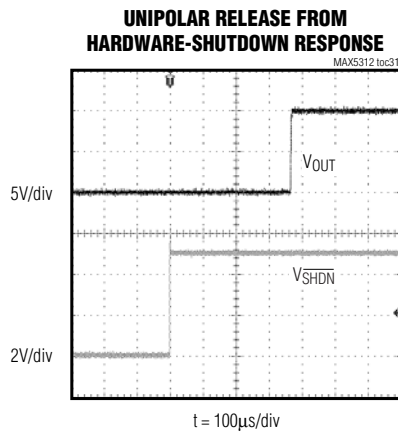
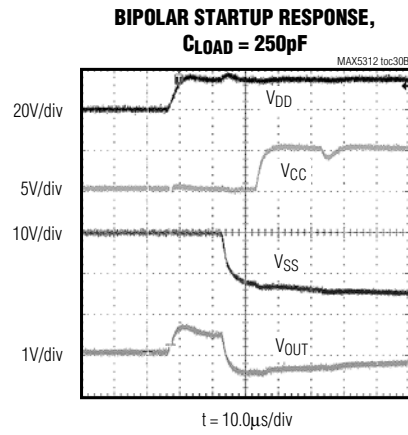
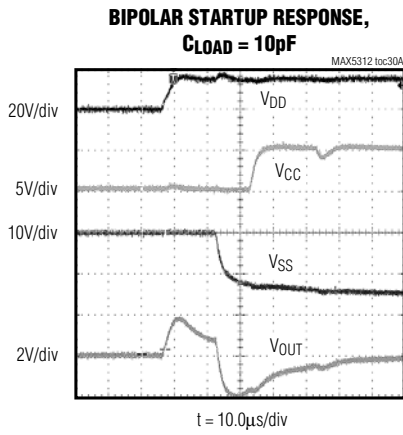

±10V, 12-Bit, Serial, Voltage-Output DAC

Pin Description

PIN	NAME	FUNCTION
1	SCLK	Serial-Clock Input. Data is shifted from DIN into the internal register on the rising edge of SCLK. Data is clocked out at DOUT on the falling edge of SCLK. SCLK is active only while \overline{CS} is low.
2	DIN	Serial-Data Input. DIN is the data input port for the serial interface. Clock data in on the rising edge of SCLK.
3	\overline{CS}	Active-Low Chip-Select Input. \overline{CS} activates the serial interface. Drive \overline{CS} low to initiate serial communication.
4	DOUT	Serial-Data Output. DOUT is the data output port for the serial interface. Data shifted into DIN appears at DOUT 16.5 clock cycles later, valid on the falling edge of SCLK. DOUT is high impedance when \overline{CS} is high.
5	DGND	Digital Ground
6	VCC	Digital Power Input. VCC ranges from +2.7V to +5.5V. Bypass VCC with a 0.1μF and 1.0μF capacitor to
7	\overline{SHDN}	Active-Low Shutdown Input. \overline{SHDN} places the device into low-power shutdown mode. When shut down REF and DOUT are high impedance, drive \overline{SHDN} low to place the device into shutdown mode.
8	UNI/ \overline{BIP}	Unipolar/Bipolar-Select Input. UNI/ \overline{BIP} selects unipolar or bipolar output. In unipolar mode, the analog output range is 0 to (+2 x VREF). In bipolar mode, the analog output range is (-2 x VREF) to (+2 x VREF). Drive UNI/ \overline{BIP} high for unipolar output. Drive UNI/ \overline{BIP} low for bipolar output. Dual supplies are required for bipolar operation.
9	OUT	Analog Output. OUT is the output port for the DAC. Read OUT relative to SGND.
10	SGND	Signal Ground. SGND is the ground-reference node for the output amplifier's internal feedback resistors. Connect SGND directly to AGND. (See Figure 1.)
11	AGND	Analog Ground. AGND is the ground return for VDD and VSS.
12	VSS	Negative Power Input. Bypass VSS with a 0.1μF and 1.0μF capacitor to AGND. If operating with a single supply, connect VSS to AGND.
13	REF	External Reference Input. Apply an external reference voltage of +2V to +5.25V to REF to determine the output voltage range. In unipolar mode, the output range is from 0 to (+2 x VREF). In bipolar mode, the output range is from (-2 x VREF) to (+2 x VREF).
14	VDD	Positive Power Input. Bypass VDD with a 0.1μF and 1.0μF capacitor to AGND.
15	\overline{CLR}	Active-Low Clear Input. \overline{CLR} clears input and DAC registers and resets the DAC output to 0V. Drive \overline{CLR} low to assert the clear condition.
16	\overline{LDAC}	Active-Low Load Input. Use \overline{LDAC} to update the DAC register. \overline{LDAC} is an asynchronous control input. Drive low to force an update.

±10V, 12-Bit, Serial, Voltage-Output DAC

MAX5312

Detailed Description

The MAX5312 12-bit DAC operates from either single or dual supplies. Dual $\pm 12\text{V}$ to $\pm 15\text{V}$ power supplies provide a bipolar $\pm 5\text{V}$ to $\pm 10\text{V}$ output, or a unipolar 0 to 10V output. Single 12V to 15V power supplies provide only a unipolar 0 to 10V output. The reference input accepts voltages from 2V to 5.25V. The DAC features INL and DNL less than ± 1 LSB (max), a fast $10\mu\text{s}$ settling time, and a hardware-shutdown mode that reduces current consumption to $3.5\mu\text{A}$ (max). The device features a 10MHz SPI-/QSPI-/MICROWIRE-compatible serial interface that operates with 3V or 5V logic, an asynchronous load input, and a serial-data output. The device offers a CLR that sets the DAC output to 0V. Figure 1 shows the functional diagram of the MAX5312.

Serial Interface

An SPI-/QSPI-/MICROWIRE-compatible serial interface allows complete control of the DAC through a 16-bit control word. The first 4 bits form the control bits that determine register loading and software-shutdown functions. The last 12 bits form the DAC data. The 16-bit word is entered MSB first.

Table 1 shows the serial-data format. Table 2 shows the interface commands.

The MAX5312 can be programmed while in shutdown.

The serial interface contains three registers: a 16-bit shift register, a 12-bit input register, and a 12-bit DAC register (Figure 1). The shift register accepts data from the serial interface. The input register acts as a holding register for data going to the DAC register and isolates the shift register from the DAC register. The DAC register controls the DAC ladder and thus the output voltage. Any update in the DAC register updates the output voltage.

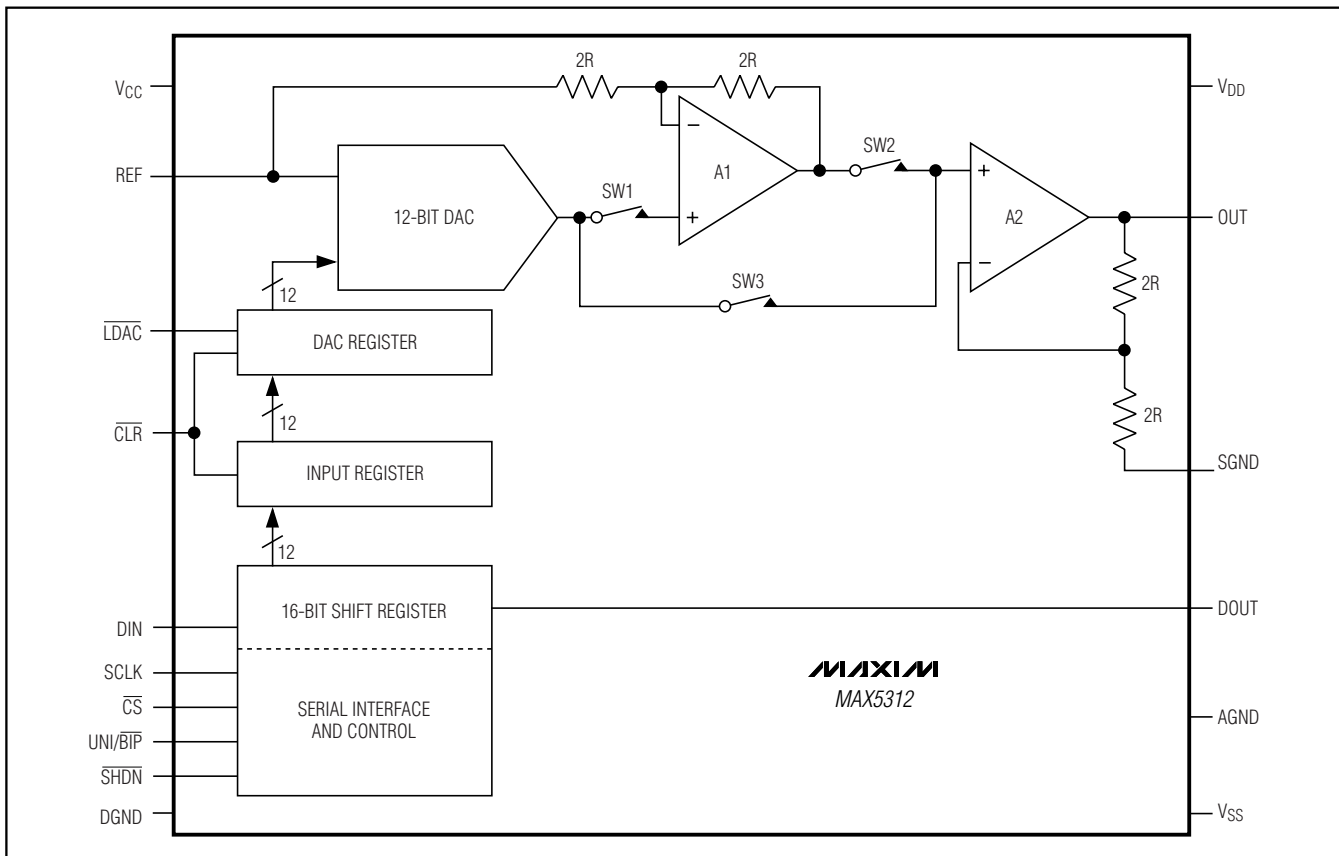

Figure 1. Functional Diagram

±10V, 12-Bit, Serial, Voltage-Output DAC

Data in the shift register is transferred to the input register during the appropriate software command only. Data in the input register is transferred to the DAC register in one of two ways: using the software command, or through external logic control using the asynchronous load input ($\overline{\text{LDAC}}$). Table 2 shows the software commands that transfer the data from the shift register to the input and/or DAC registers. The $\overline{\text{CLR}}$, an external logic control, asynchronously forces the input and DAC registers to zero code, and the output to 0V, in both unipolar and bipolar modes. The interface timing is shown in Figures 2 and 3.

Wait a minimum of 100ns after $\overline{\text{CS}}$ goes high before implementing $\overline{\text{LDAC}}$ or $\overline{\text{CLR}}$. If either of these logic inputs activates during a data transfer, the incoming data is corrupted and needs to be reloaded. For software control only, connect $\overline{\text{LDAC}}$ and $\overline{\text{CLR}}$ high.

DAC Architecture

The MAX5312 uses an inverted DAC ladder architecture to convert the digital input into an analog output voltage. The digital input controls weighted-switches that connect the DAC ladder nodes to either REF or GND (Figure 4). The sum of the weights produces the analog equivalent of the digital-input word and is then buffered at the output.

Table 1. Serial-Data Format

CONTROL BITS				DATA BITS												
MSB																LSB
C3	C2	C1	C0	D11	D10	D9	D8	D7	D6	D5	D4	D3	D2	D1	D0	

Table 2. Serial-Interface Programming Commands

CONTROL BITS*				INPUT DATA	FUNCTION
C3	C2	C1	C0	D11–D0	
0	0	0	0	XXXXXXXXXXXX	No operation; command is ignored.
0	0	1	0	12-bit DAC data	Load input register from shift register; DAC output unchanged.
0	1	0	0	12-bit DAC data	Load input and DAC registers from shift register; DAC output updated.
0	1	1	0	XXXXXXXXXXXX	Load DAC register from input register; DAC output updated; input register unchanged.
1	0	0	0	XXXXXXXXXXXX	Enter shutdown; input and DAC registers unchanged.
1	1	0	0	XXXXXXXXXXXX	Exit shutdown; input and DAC registers unchanged.

X = Don't care.

*All unlisted commands are reserved commands. Do not use.

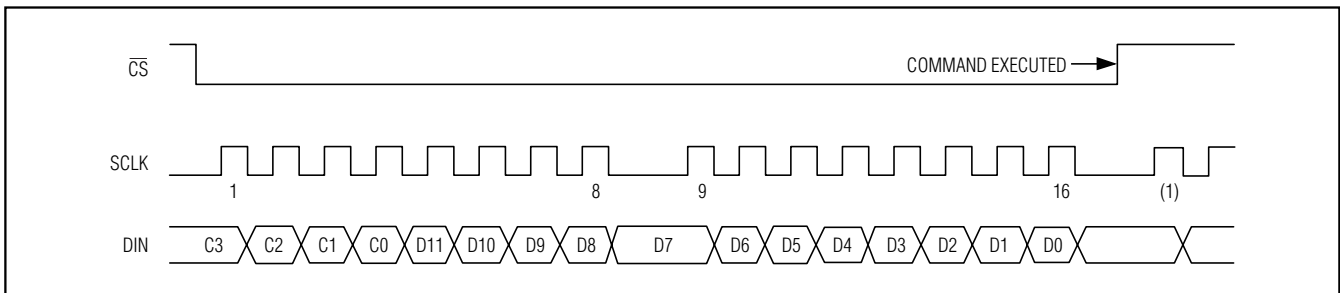

Figure 2. Serial-Interface Signals

±10V, 12-Bit, Serial, Voltage-Output DAC

MAX5312

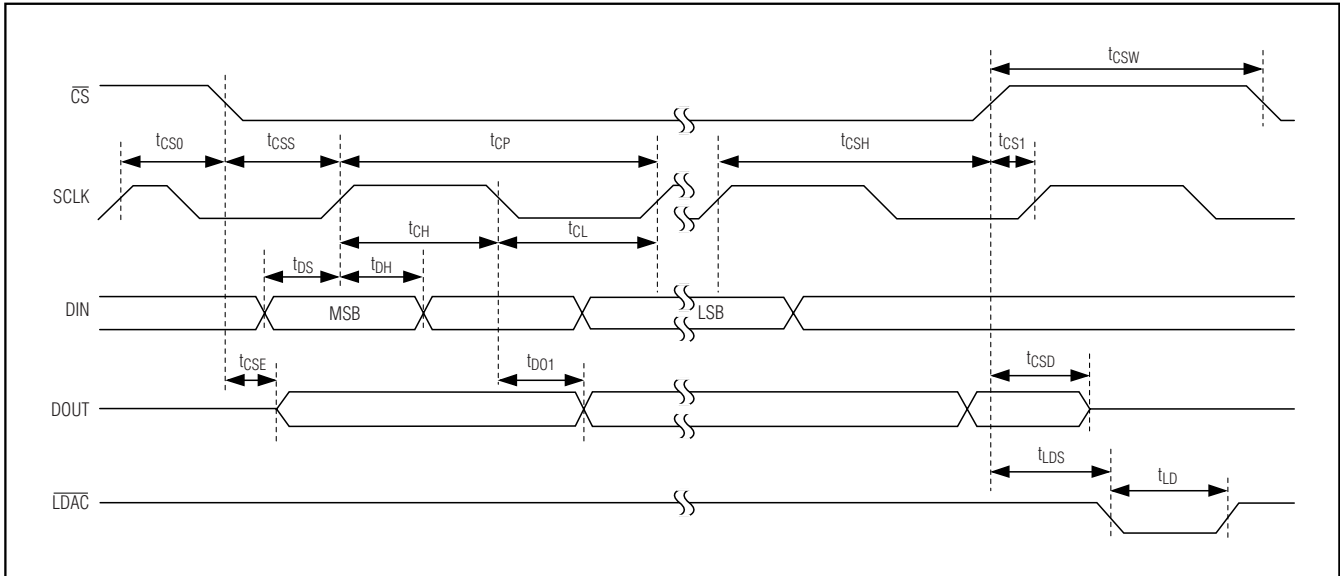

Figure 3. Serial-Interface Timing Diagram

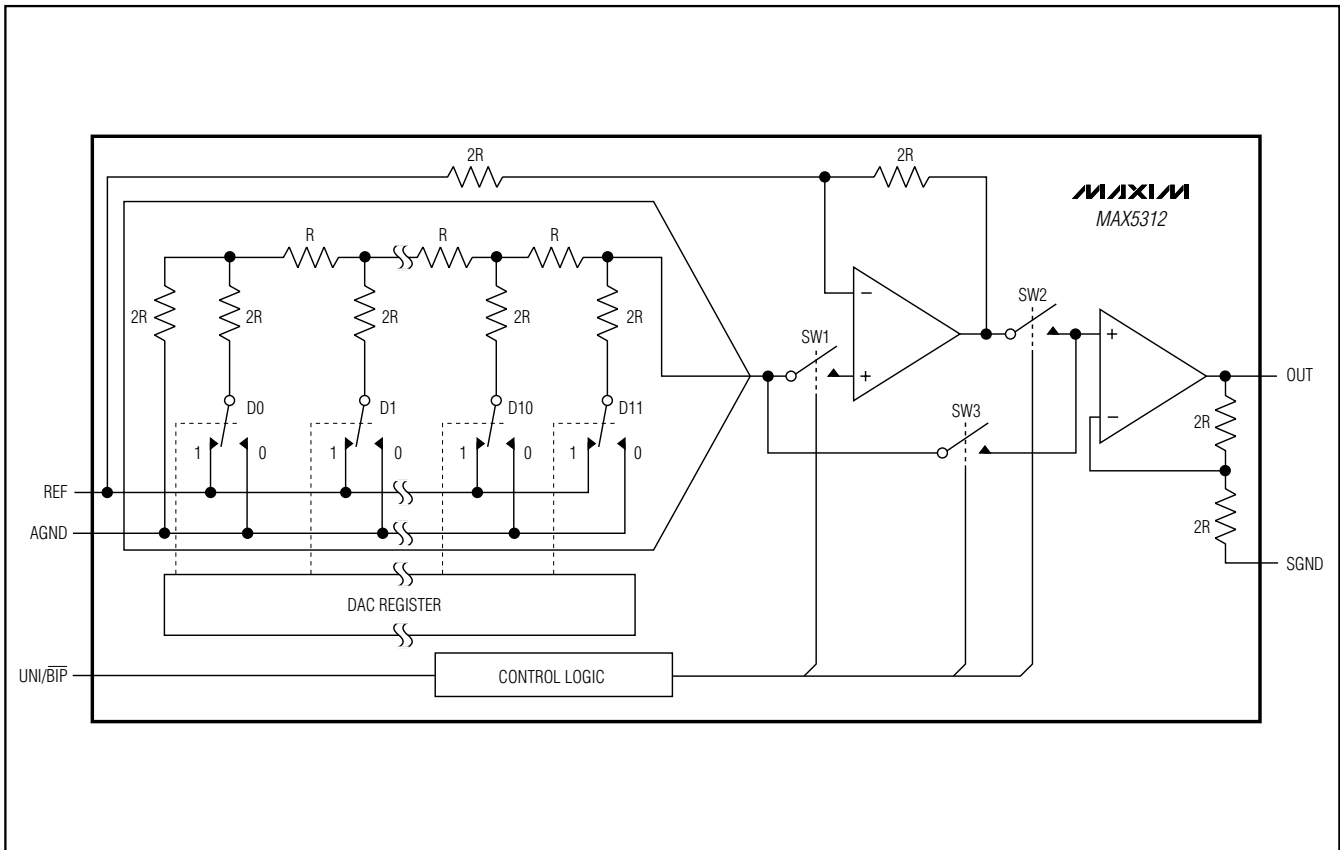

Figure 4. Basic Inverted DAC Ladder

±10V, 12-Bit, Serial, Voltage-Output DAC

External Reference and Transfer Functions

Connect an external 2V to 5.25V reference to REF (the MAX6350 is recommended). Set the output voltage range with the reference and the input code by using the equations below.

Unipolar Output Voltage:

$$V_{OUT_UNI} = LSB_{UNI} \times CODE$$

where

$$LSB_{UNI} = \frac{2 \times V_{REF}}{2^{12}}$$

Bipolar Output Voltage:

$$V_{OUT_BIP} = (LSB_{BIP} \times CODE) - (2 \times V_{REF})$$

where

$$LSB_{BIP} = \frac{4 \times V_{REF}}{2^{12}}$$

where V_{OUT_UNI} is the unipolar output voltage, V_{OUT_BIP} is the bipolar output voltage, LSB_{UNI} is the unipolar LSB step size, LSB_{BIP} is the bipolar LSB step size, V_{REF} is the reference voltage, and CODE is the decimal equivalent of the binary, 12-bit, DAC input code.

In either case, a 000hex input code produces the minimum output ($-2 \times V_{REF}$ for bipolar and 0 for unipolar), an 800hex input code produces the midscale output (0 for bipolar and V_{REF} for unipolar), and a FFFhex input code produces the full-scale output ($2 \times V_{REF}$ for bipolar and unipolar).

Output Amplifiers

The output-amplifier section can be configured as either unipolar or bipolar by the UNI/BIP logic input. With UNI/BIP forced low, SW1 and SW2 in Figure 4 are closed, and SW3 is open. This configuration channels the DAC output through two output stages to generate the $\pm 2 \times V_{REF}$ output swing. The first amplifier generates the $\pm V_{REF}$ voltage range and the second amplifier increases it by two. When configured for bipolar operation, the MAX5312 must be driven with dual $\pm 12V$ to $\pm 15V$ power supplies.

With UNI/BIP forced high, switches SW1 and SW2 are open, and SW3 is closed. This configuration channels the DAC output through only a single gain stage to generate a 0 to ($2 \times V_{REF}$) output swing.

Daisy Chaining

SPI-/QSPI-/MICROWIRE-compatible devices can be daisy chained to reduce I/O lines from the host controller (Figure 7). Daisy chain devices by connecting the DOUT of one device to the DIN of the next, and connect the SCLK of all devices to a common clock. Data is shifted out of DOUT 16.5 clock cycles after it is shifted into DIN, and is available on the rising edge of the 17th clock cycle. The SPI-/QSPI-/MICROWIRE-compatible serial interface normally works at up to 10MHz, but must be slowed to 6.0MHz if daisy chaining. DOUT is high impedance when \overline{CS} is high.

Shutdown

Shutdown is controlled by software commands or by the SHDN logic input. The SHDN logic input can be implemented at any time. The SPI-/QSPI-/MICROWIRE-compatible serial interface remains fully functional, and the device is programmable while shut down. When shut down, the MAX5312 supply current reduces to 3.5 μ A, DOUT is high impedance, and OUT is pulled to SGND through the internal feedback resistors of the output amplifier (Figure 1). When coming out of shutdown, or during device power-up, allow 350 μ s for the output to stabilize.

Table 3. Output Voltage as Input Code Examples

BINARY DAC CODE		ANALOG OUTPUT	
MSB	LSB	UNIPOLAR (UNI/BIP ₋ = HIGH)	BIPOLAR (UNI/BIP ₋ = LOW)
1111	1111 1111	+2 × V _{REF} (4095 / 4096)	+2 × V _{REF} (2047 / 2048)
1000	0000 0001	+2 × V _{REF} (2049 / 4096)	+2 × V _{REF} (1 / 2048)
1000	0000 0000	+2 × V _{REF} (2048 / 4096) = V _{REF}	0
0111	1111 1111	+2 × V _{REF} (2047 / 4096)	-2 × V _{REF} (1 / 2048)
0000	0000 0001	+2 × V _{REF} (1 / 4096)	-2 × V _{REF} (2047 / 2048)
0000	0000 0000	0	-2 × V _{REF} (2048 / 2048) = -2 × V _{REF}

±10V, 12-Bit, Serial, Voltage-Output DAC

MAX5312

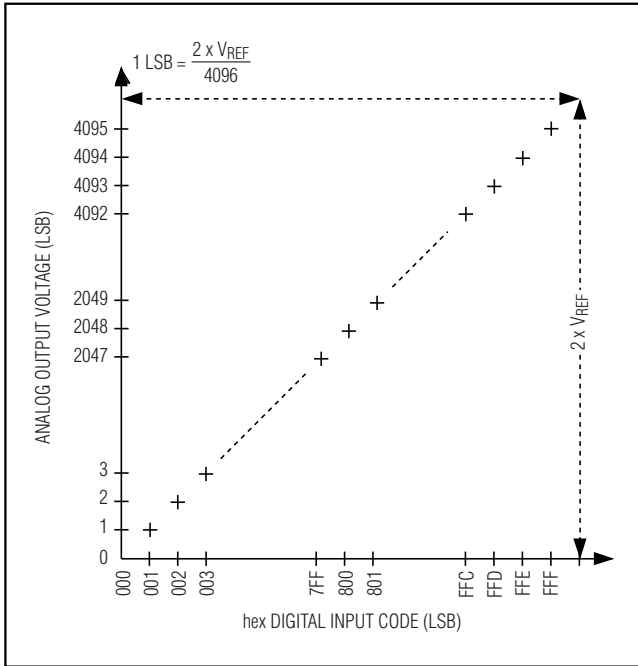

Figure 5. Unipolar Transfer Function

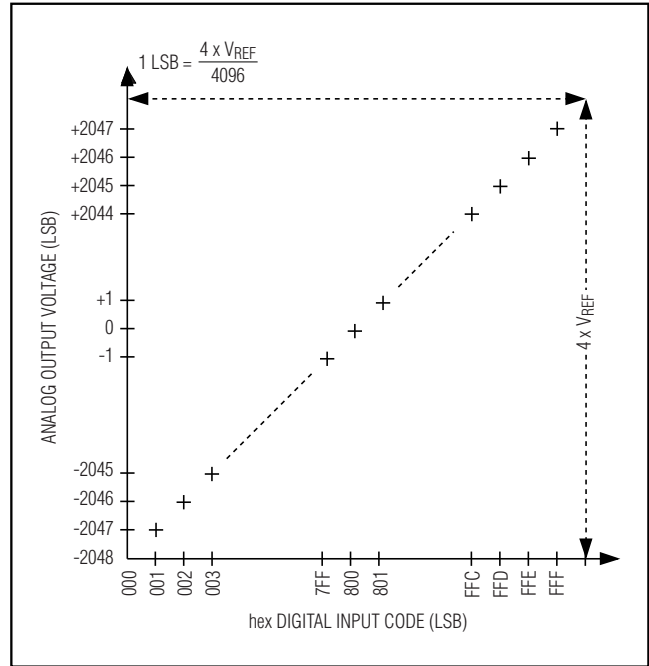

Figure 6. Bipolar Transfer Function

Applications Information

Power Supplies

A single +12V to +15V supply is required to realize a 0 to 10V output swing. A dual ±12V to ±15V supply is required to realize a ±10V output swing, and allows unipolar, 0 to +10V output if UNI/BIP is forced high. A +3V to +5V digital power supply and a +2.000V to +5.250V external reference voltage are also required. Always bring up the reference voltage last. The other power supplies do not require sequencing.

Power-Supply Bypassing and Ground Management

Bypass V_{DD} and V_{SS} with 0.1 μ F and 1.0 μ F capacitors to AGND, and bypass V_{CC} with 0.1 μ F and 1.0 μ F capacitors to DGND. Minimize trace lengths to reduce inductance. Digital and AC transient signals on AGND or DGND can create noise at the output. Connect AGND and DGND to the highest quality ground available. Use proper grounding techniques, such as a multilayer board with a low-inductance ground plane or star connect all ground-return paths back to AGND. Carefully lay out the traces between channels to reduce AC crosscoupling and crosstalk. Wire-wrapped boards, sockets, and breadboards are not recommended.

±10V, 12-Bit, Serial, Voltage-Output DAC

MAX5312

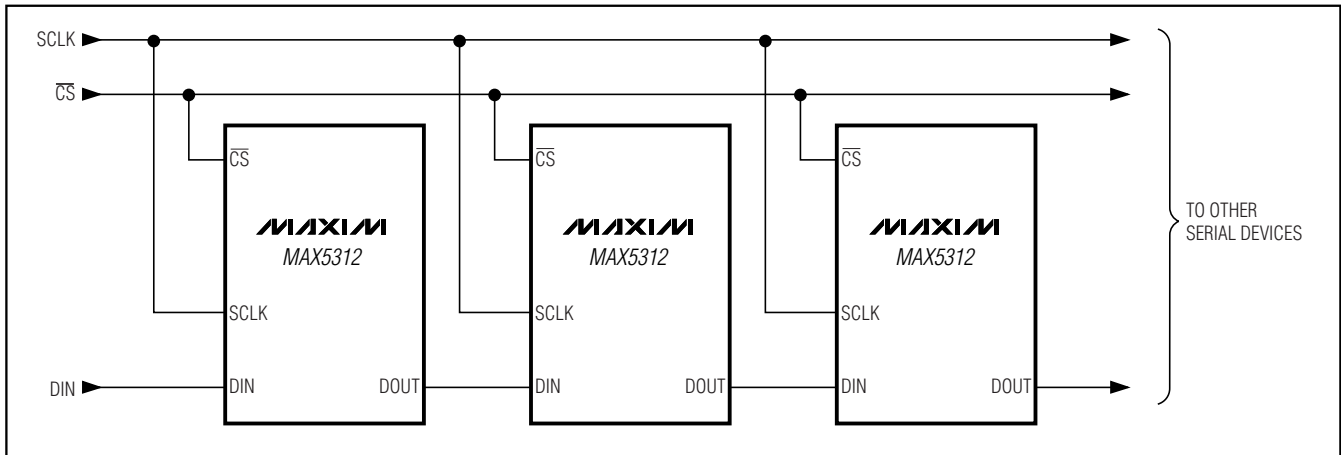

Figure 7. Daisy Chaining Devices

Chip Information

TRANSISTOR COUNT: 3280

TECHNOLOGY: BiCMOS

±10V, 12-Bit, Serial, Voltage-Output DAC

Package Information

(The package drawing(s) in this data sheet may not reflect the most current specifications. For the latest package outline information, go to www.maxim-ic.com/packages.)

MAX5312

DIM	INCHES		MILLIMETERS	
	MIN	MAX	MIN	MAX
A	0.068	0.078	1.73	1.99
A1	0.002	0.008	0.05	0.21
B	0.010	0.015	0.25	0.38
C	0.004	0.008	0.09	0.20
D	SEE VARIATIONS			
E	0.205	0.212	5.20	5.38
e	0.0256 BSC		0.65 BSC	
H	0.301	0.311	7.65	7.90
L	0.025	0.037	0.63	0.95
α	0°	8°	0°	8°

D	INCHES		MILLIMETERS		N
	MIN	MAX	MIN	MAX	
D	0.239	0.249	6.07	6.33	14L
D	0.239	0.249	6.07	6.33	16L
D	0.278	0.289	7.07	7.33	20L
D	0.317	0.328	8.07	8.33	24L
D	0.397	0.407	10.07	10.33	28L

NOTES:

- D & E DO NOT INCLUDE MOLD FLASH.
- MOLD FLASH OR PROTRUSIONS NOT TO EXCEED .15 MM (.006").
- CONTROLLING DIMENSION: MILLIMETERS.
- MEETS JEDEC MO150.
- LEADS TO BE COPLANAR WITHIN 0.10 MM.

DALLAS SEMICONDUCTOR **MAXIM**

PROPRIETARY INFORMATION

TITLE: PACKAGE OUTLINE, SSOP, 5.3 MM

APPROVAL: _____ DOCUMENT CONTROL NO. 21-0056 REV. C 1/1

SSOP EPFS

Maxim cannot assume responsibility for use of any circuitry other than circuitry entirely embodied in a Maxim product. No circuit patent licenses are implied. Maxim reserves the right to change the circuitry and specifications without notice at any time.

Maxim Integrated Products, 120 San Gabriel Drive, Sunnyvale, CA 94086 408-737-7600 _____ 19



Компания «ЭлектроПласт» предлагает заключение долгосрочных отношений при поставках импортных электронных компонентов на взаимовыгодных условиях!

Наши преимущества:

- Оперативные поставки широкого спектра электронных компонентов отечественного и импортного производства напрямую от производителей и с крупнейших мировых складов;
- Поставка более 17-ти миллионов наименований электронных компонентов;
- Поставка сложных, дефицитных, либо снятых с производства позиций;
- Оперативные сроки поставки под заказ (от 5 рабочих дней);
- Экспресс доставка в любую точку России;
- Техническая поддержка проекта, помощь в подборе аналогов, поставка прототипов;
- Система менеджмента качества сертифицирована по Международному стандарту ISO 9001;
- Лицензия ФСБ на осуществление работ с использованием сведений, составляющих государственную тайну;
- Поставка специализированных компонентов (Xilinx, Altera, Analog Devices, Intersil, Interpoint, Microsemi, Aeroflex, Peregrine, Syfer, Eurofarad, Texas Instrument, Miteq, Cobham, E2V, MA-COM, Hittite, Mini-Circuits, General Dynamics и др.);

Помимо этого, одним из направлений компании «ЭлектроПласт» является направление «Источники питания». Мы предлагаем Вам помощь Конструкторского отдела:

- Подбор оптимального решения, техническое обоснование при выборе компонента;
- Подбор аналогов;
- Консультации по применению компонента;
- Поставка образцов и прототипов;
- Техническая поддержка проекта;
- Защита от снятия компонента с производства.



Как с нами связаться

Телефон: 8 (812) 309 58 32 (многоканальный)

Факс: 8 (812) 320-02-42

Электронная почта: org@eplast1.ru

Адрес: 198099, г. Санкт-Петербург, ул. Калинина, дом 2, корпус 4, литера А.