

### FEATURES

- 2.1  $\Omega$  on resistance
- 0.5  $\Omega$  maximum on resistance flatness
- Up to 250 mA continuous current
- Fully specified at  $+12$  V,  $\pm 15$  V,  $\pm 5$  V
- No  $V_L$  supply required
- 3 V logic-compatible inputs
- Rail-to-rail operation
- 10-lead MSOP and 10-lead, 3 mm  $\times$  3 mm LFCSP packages

### APPLICATIONS

- Automatic test equipment
- Data acquisition systems
- Relay replacements
- Battery-powered systems
- Sample-and-hold systems
- Audio signal routing
- Video signal routing
- Communication systems

### GENERAL DESCRIPTION

The ADG1421/ADG1422/ADG1423 contain two independent single-pole/single-throw (SPST) switches. The ADG1421 and ADG1422 differ only in that the digital control logic is inverted. The ADG1421 switches are turned on with Logic 1 on the appropriate control input, and Logic 0 is required for the ADG1422. The ADG1423 has one switch with digital control logic similar to that of the ADG1421; the logic is inverted on the other switch. The ADG1423 exhibits break-before-make switching action for use in multiplexer applications. Each switch conducts equally well in both directions when on and has an input signal range that extends to the supplies. In the off condition, signal levels up to the supplies are blocked.

The iCMOS<sup>®</sup> (industrial CMOS) modular manufacturing process combines high voltage, complementary metal-oxide semiconductor (CMOS) and bipolar technologies. It enables the development of a wide range of high performance analog ICs capable of 33 V operation in a footprint that no other generation of high voltage parts has achieved. Unlike analog ICs using conventional CMOS processes, iCMOS components can tolerate high supply voltages while providing increased performance, dramatically lower power consumption, and reduced package size.

### FUNCTIONAL BLOCK DIAGRAM

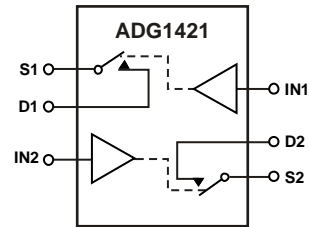

SWITCHES SHOWN FOR A LOGIC 0 INPUT

Figure 1. ADG1421 Functional Block Diagram

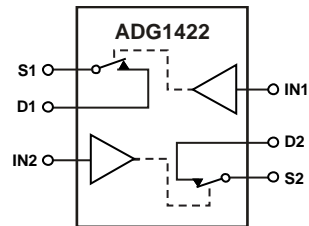

SWITCHES SHOWN FOR A LOGIC 0 INPUT

Figure 2. ADG1422 Functional Block Diagram

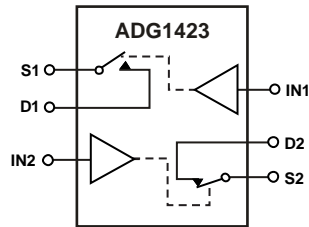

SWITCHES SHOWN FOR A LOGIC 0 INPUT

Figure 3. ADG1423 Functional Block Diagram

The on resistance profile is very flat over the full analog input range ensuring excellent linearity and low distortion when switching audio signals. The iCMOS construction ensures ultralow power dissipation, making the part ideally suited for portable and battery-powered instruments.

### PRODUCT HIGHLIGHTS

1. 2.4  $\Omega$  maximum on resistance at 25°C.
2. Minimum distortion.
3. 3 V logic-compatible digital inputs:  $V_{INH} = 2.0$  V,  $V_{INL} = 0.8$  V.
4. No  $V_L$  logic power supply required.
5. 10-lead MSOP and 10-lead, 3 mm  $\times$  3 mm LFCSP packages.

Rev. A

[Document Feedback](#)

Information furnished by Analog Devices is believed to be accurate and reliable. However, no responsibility is assumed by Analog Devices for its use, nor for any infringements of patents or other rights of third parties that may result from its use. Specifications subject to change without notice. No license is granted by implication or otherwise under any patent or patent rights of Analog Devices. Trademarks and registered trademarks are the property of their respective owners.

**TABLE OF CONTENTS**

Features .....	1	Continuous Current per Channel, S or D .....	6
Applications .....	1	Absolute Maximum Ratings .....	7
General Description .....	1	Thermal Resistance .....	7
Functional Block Diagram .....	1	ESD Caution .....	7
Product Highlights .....	1	Pin Configuration and Function Descriptions .....	8
Revision History .....	2	Typical Performance Characteristics .....	9
Specifications .....	3	Test Circuits .....	12
±15 V Dual Supply .....	3	Terminology .....	14
+12 V Single Supply .....	4	Outline Dimensions .....	15
±5 V Dual Supply .....	5	Ordering Guide .....	16

**REVISION HISTORY**

**7/14—Rev. 0 to Rev. A**

Changes to Table 1 .....	3
Updated Outline Dimensions .....	15

**10/09—Revision 0: Initial Version**

## SPECIFICATIONS

## ±15 V DUAL SUPPLY

$V_{DD} = +15\text{ V} \pm 10\%$ ,  $V_{SS} = -15\text{ V} \pm 10\%$ , GND = 0 V, unless otherwise noted.

Table 1.

Parameter	25°C	-40°C to +85°C	-40°C to +105°C	-40°C to +125°C	Unit	Test Conditions/Comments
<b>ANALOG SWITCH</b>						
Analog Signal Range				$V_{DD}$ to $V_{SS}$	V	
On Resistance, $R_{ON}$	2.1				$\Omega$ typ	$V_S = \pm 10\text{ V}$ , $I_S = -10\text{ mA}$ ; see Figure 23
	2.4	2.8	2.95	3.2	$\Omega$ max	$V_{DD} = +13.5\text{ V}$ , $V_{SS} = -13.5\text{ V}$
On Resistance Match Between Channels, $\Delta R_{ON}$	0.02				$\Omega$ typ	$V_S = \pm 10\text{ V}$ , $I_S = -10\text{ mA}$
	0.1	0.12	0.124	0.13	$\Omega$ max	
On Resistance Flatness, $R_{FLAT(ON)}$	0.4				$\Omega$ typ	$V_S = \pm 10\text{ V}$ , $I_S = -10\text{ mA}$
	0.5	0.6	0.63	0.65	$\Omega$ max	
<b>LEAKAGE CURRENTS</b>						
Source Off Leakage, $I_S$ (Off)	$\pm 0.1$				nA typ	$V_{DD} = +16.5\text{ V}$ , $V_{SS} = -16.5\text{ V}$
	$\pm 0.5$	$\pm 2$	$\pm 9$	$\pm 75$	nA max	$V_S = \pm 10\text{ V}$ , $V_D = \pm 10\text{ V}$ ; see Figure 24
Drain Off Leakage, $I_D$ (Off)	$\pm 0.1$				nA typ	$V_S = \pm 10\text{ V}$ , $V_D = \pm 10\text{ V}$ ; see Figure 24
	$\pm 0.5$	$\pm 2$	$\pm 9$	$\pm 75$	nA max	
Channel On Leakage, $I_D$ , $I_S$ (On)	$\pm 0.2$				nA typ	$V_S = V_D = \pm 10\text{ V}$ ; see Figure 25
	$\pm 1$	$\pm 2$	$\pm 9$	$\pm 75$	nA max	
<b>DIGITAL INPUTS</b>						
Input High Voltage, $V_{INH}$				2.0	V min	
Input Low Voltage, $V_{INL}$				0.8	V max	
Input Current, $I_{INL}$ or $I_{INH}$	0.005				$\mu\text{A}$ typ	$V_{IN} = V_{GND}$ or $V_{DD}$
				$\pm 0.1$	$\mu\text{A}$ max	
Digital Input Capacitance, $C_{IN}$	4				pF typ	
<b>DYNAMIC CHARACTERISTICS<sup>1</sup></b>						
$t_{ON}$	115				ns typ	$R_L = 300\ \Omega$ , $C_L = 35\text{ pF}$
	145	180		210	ns max	$V_S = 10\text{ V}$ ; see Figure 26
$t_{OFF}$	115				ns typ	$R_L = 300\ \Omega$ , $C_L = 35\text{ pF}$
	145	165		190	ns max	$V_S = 10\text{ V}$ ; see Figure 26
Break-Before-Make Time Delay, $t_D$ (ADG1423 Only)	45				ns typ	$R_L = 300\ \Omega$ , $C_L = 35\text{ pF}$
				30	ns min	$V_{S1} = V_{S2} = 10\text{ V}$ ; see Figure 27
Charge Injection	-5				pC typ	$V_S = 0\text{ V}$ , $R_S = 0\ \Omega$ , $C_L = 1\text{ nF}$ ; see Figure 28
Off Isolation	-64				dB typ	$R_L = 50\ \Omega$ , $C_L = 5\text{ pF}$ , $f = 1\text{ MHz}$ ; see Figure 29
Channel-to-Channel Crosstalk	-74				dB typ	$R_L = 50\ \Omega$ , $C_L = 5\text{ pF}$ , $f = 1\text{ MHz}$ ; see Figure 30
Total Harmonic Distortion + Noise	0.016				% typ	$R_L = 10\text{ k}\Omega$ , $5\text{ V rms}$ , $f = 20\text{ Hz}$ to $20\text{ kHz}$ ; see Figure 32
-3 dB Bandwidth	180				MHz typ	$R_L = 50\ \Omega$ , $C_L = 5\text{ pF}$ ; see Figure 31
Insertion Loss	0.12				dB typ	$R_L = 50\ \Omega$ , $C_L = 5\text{ pF}$ , $f = 1\text{ MHz}$ ; see Figure 31
$C_S$ (Off)	18				pF typ	$f = 1\text{ MHz}$ ; $V_S = 0\text{ V}$
$C_D$ (Off)	22				pF typ	$f = 1\text{ MHz}$ ; $V_S = 0\text{ V}$
$C_D$ , $C_S$ (On)	86				pF typ	$f = 1\text{ MHz}$ ; $V_S = 0\text{ V}$
<b>POWER REQUIREMENTS</b>						
$I_{DD}$	0.002				$\mu\text{A}$ typ	$V_{DD} = +16.5\text{ V}$ , $V_{SS} = -16.5\text{ V}$
				1.0	$\mu\text{A}$ max	Digital inputs = 0 V or $V_{DD}$
$I_{DD}$	120				$\mu\text{A}$ typ	Digital inputs = 5 V
				190	$\mu\text{A}$ max	
$I_{SS}$	0.002				$\mu\text{A}$ typ	Digital inputs = 0 V, 5 V, or $V_{DD}$
				1.0	$\mu\text{A}$ max	
$V_{DD}/V_{SS}$				$\pm 4.5/\pm 16.5$	V min/max	Ground = 0 V

<sup>1</sup> Guaranteed by design, not subject to production test.

**+12 V SINGLE SUPPLY**

$V_{DD} = 12\text{ V} \pm 10\%$ ,  $V_{SS} = 0\text{ V}$ ,  $GND = 0\text{ V}$ , unless otherwise noted.

**Table 2.**

Parameter	25°C	-40°C to +85°C	-40°C to +125°C	Unit	Test Conditions/Comments
<b>ANALOG SWITCH</b>					
Analog Signal Range			0 V to $V_{DD}$	V	
On Resistance, $R_{ON}$	4			$\Omega$ typ	$V_S = 0\text{ V to }10\text{ V}$ , $I_S = -10\text{ mA}$ ; see Figure 23
	4.6	5.5	6.2	$\Omega$ max	$V_{DD} = 10.8\text{ V}$ , $V_{SS} = 0\text{ V}$
On Resistance Match Between Channels, $\Delta R_{ON}$	0.03			$\Omega$ typ	$V_S = 0\text{ V to }10\text{ V}$ , $I_S = -10\text{ mA}$
	0.15	0.17	0.18	$\Omega$ max	
On Resistance Flatness, $R_{FLAT(ON)}$	1.2			$\Omega$ typ	$V_S = 0\text{ V to }10\text{ V}$ , $I_S = -10\text{ mA}$
	1.5	1.75	1.9	$\Omega$ max	
<b>LEAKAGE CURRENTS</b>					
Source Off Leakage, $I_S$ (Off)	$\pm 0.05$			nA typ	$V_{DD} = 13.2\text{ V}$ , $V_{SS} = 0\text{ V}$
	$\pm 0.5$	$\pm 2$	$\pm 75$	nA max	$V_S = 1\text{ V}/10\text{ V}$ , $V_D = 10\text{ V}/1\text{ V}$ ; see Figure 24
Drain Off Leakage, $I_D$ (Off)	$\pm 0.05$			nA typ	$V_S = 1\text{ V}/10\text{ V}$ , $V_D = 10\text{ V}/1\text{ V}$ ; see Figure 24
	$\pm 0.5$	$\pm 2$	$\pm 75$	nA max	
Channel On Leakage, $I_D$ , $I_S$ (On)	$\pm 0.1$			nA typ	$V_S = V_D = 1\text{ V or }10\text{ V}$ ; see Figure 25
	$\pm 1$	$\pm 2$	$\pm 75$	nA max	
<b>DIGITAL INPUTS</b>					
Input High Voltage, $V_{INH}$			2.0	V min	
Input Low Voltage, $V_{INL}$			0.8	V max	
Input Current, $I_{INL}$ or $I_{INH}$	0.005			$\mu\text{A}$ typ	$V_{IN} = V_{GND}$ or $V_{DD}$
			$\pm 0.1$	$\mu\text{A}$ max	
Digital Input Capacitance, $C_{IN}$	4			pF typ	
<b>DYNAMIC CHARACTERISTICS<sup>1</sup></b>					
$t_{ON}$	180			ns typ	$R_L = 300\ \Omega$ , $C_L = 35\text{ pF}$
	230	295	340	ns max	$V_S = 8\text{ V}$ ; see Figure 26
$t_{OFF}$	130			ns typ	$R_L = 300\ \Omega$ , $C_L = 35\text{ pF}$
	165	205	235	ns max	$V_S = 8\text{ V}$ ; see Figure 26
Break-Before-Make Time Delay, $t_D$ (ADG1423 Only)	70			ns typ	$R_L = 300\ \Omega$ , $C_L = 35\text{ pF}$
			48	ns min	$V_{S1} = V_{S2} = 8\text{ V}$ ; see Figure 27
Charge Injection	30			pC typ	$V_S = 6\text{ V}$ , $R_S = 0\ \Omega$ , $C_L = 1\text{ nF}$ ; see Figure 28
Off Isolation	-60			dB typ	$R_L = 50\ \Omega$ , $C_L = 5\text{ pF}$ , $f = 1\text{ MHz}$ ; see Figure 29
Channel-to-Channel Crosstalk	-70			dB typ	$R_L = 50\ \Omega$ , $C_L = 5\text{ pF}$ , $f = 1\text{ MHz}$ ; see Figure 30
-3 dB Bandwidth	140			MHz typ	$R_L = 50\ \Omega$ , $C_L = 5\text{ pF}$ ; see Figure 31
Insertion Loss	0.26			dB typ	$R_L = 50\ \Omega$ , $C_L = 5\text{ pF}$ , $f = 1\text{ MHz}$ ; see Figure 31
$C_S$ (Off)	31			pF typ	$f = 1\text{ MHz}$ ; $V_S = 6\text{ V}$
$C_D$ (Off)	36			pF typ	$f = 1\text{ MHz}$ ; $V_S = 6\text{ V}$
$C_D$ , $C_S$ (On)	90			pF typ	$f = 1\text{ MHz}$ ; $V_S = 6\text{ V}$
<b>POWER REQUIREMENTS</b>					
$I_{DD}$	0.001			$\mu\text{A}$ typ	$V_{DD} = 13.2\text{ V}$
			1.0	$\mu\text{A}$ max	Digital inputs = 0 V or $V_{DD}$
$I_{DD}$	120			$\mu\text{A}$ typ	Digital inputs = 5 V
			190	$\mu\text{A}$ max	
$V_{DD}$			5/16.5	V min/max	Ground = 0 V, $V_{SS} = 0\text{ V}$

<sup>1</sup> Guaranteed by design, not subject to production test.

**±5 V DUAL SUPPLY**

$V_{DD} = +5\text{ V} \pm 10\%$ ,  $V_{SS} = -5\text{ V} \pm 10\%$ ,  $GND = 0\text{ V}$ , unless otherwise noted.

**Table 3.**

Parameter	25°C	-40°C to +85°C	-40°C to +125°C	Unit	Test Conditions/Comments
<b>ANALOG SWITCH</b>					
Analog Signal Range			$V_{DD}$ to $V_{SS}$	V	
On Resistance, $R_{ON}$	4.5			$\Omega$ typ	$V_S = \pm 4.5\text{ V}$ , $I_S = -10\text{ mA}$ ; see Figure 23
	5.2	6.2	7	$\Omega$ max	$V_{DD} = +4.5\text{ V}$ , $V_{SS} = -4.5\text{ V}$
On Resistance Match Between Channels, $\Delta R_{ON}$	0.04			$\Omega$ typ	$V_S = \pm 4.5\text{ V}$ ; $I_S = -10\text{ mA}$
	0.18	0.2	0.21	$\Omega$ max	
On Resistance Flatness, $R_{FLAT(ON)}$	1.3			$\Omega$ typ	$V_S = \pm 4.5\text{ V}$ , $I_S = -10\text{ mA}$
	1.6	1.85	2	$\Omega$ max	
<b>LEAKAGE CURRENTS</b>					
Source Off Leakage, $I_S$ (Off)	$\pm 0.05$			nA typ	$V_{DD} = +5.5\text{ V}$ , $V_{SS} = -5.5\text{ V}$
	$\pm 0.5$	$\pm 2$	$\pm 75$	nA max	$V_S = \pm 4.5\text{ V}$ , $V_D = \mp 4.5\text{ V}$ ; see Figure 24
Drain Off Leakage, $I_D$ (Off)	$\pm 0.05$			nA typ	$V_S = \pm 4.5\text{ V}$ , $V_D = \mp 4.5\text{ V}$ ; see Figure 24
	$\pm 0.5$	$\pm 2$	$\pm 75$	nA max	
Channel On Leakage, $I_D$ , $I_S$ (On)	$\pm 0.1$			nA typ	$V_S = V_D = \pm 4.5\text{ V}$ ; see Figure 25
	$\pm 1$	$\pm 2$	$\pm 75$	nA max	
<b>DIGITAL INPUTS</b>					
Input High Voltage, $V_{INH}$			2.0	V min	
Input Low Voltage, $V_{INL}$			0.8	V max	
Input Current, $I_{INL}$ or $I_{INH}$	0.005			$\mu\text{A}$ typ	$V_{IN} = V_{GND}$ or $V_{DD}$
			$\pm 0.1$	$\mu\text{A}$ max	
Digital Input Capacitance, $C_{IN}$	4			pF typ	
<b>DYNAMIC CHARACTERISTICS<sup>1</sup></b>					
$t_{ON}$	285			ns typ	$R_L = 300\ \Omega$ , $C_L = 35\text{ pF}$
	370	460	520	ns max	$V_S = 3\text{ V}$ ; see Figure 26
$t_{OFF}$	220			ns typ	$R_L = 300\ \Omega$ , $C_L = 35\text{ pF}$
	295	350	395	ns max	$V_S = 3\text{ V}$ ; see Figure 26
Break-Before-Make Time Delay, $t_D$ (ADG1423 Only)	85			ns typ	$R_L = 300\ \Omega$ , $C_L = 35\text{ pF}$
			45	ns min	$V_{S1} = V_{S2} = 3\text{ V}$ ; see Figure 27
Charge Injection	82			pC typ	$V_S = 0\text{ V}$ , $R_S = 0\ \Omega$ , $C_L = 1\text{ nF}$ ; see Figure 28
Off Isolation	-60			dB typ	$R_L = 50\ \Omega$ , $C_L = 5\text{ pF}$ , $f = 1\text{ MHz}$ ; see Figure 29
Channel-to-Channel Crosstalk	-70			dB typ	$R_L = 50\ \Omega$ , $C_L = 5\text{ pF}$ , $f = 1\text{ MHz}$ ; see Figure 30
Total Harmonic Distortion + Noise	0.04			% typ	$R_L = 10\text{ k}\Omega$ , 5 V p-p, $f = 20\text{ Hz}$ to 20 kHz; see Figure 32
-3 dB Bandwidth	150			MHz typ	$R_L = 50\ \Omega$ , $C_L = 5\text{ pF}$ ; see Figure 31
Insertion Loss	0.25			dB typ	$R_L = 50\ \Omega$ , $C_L = 5\text{ pF}$ , $f = 1\text{ MHz}$ ; see Figure 31
$C_S$ (Off)	25			pF typ	$V_S = 0\text{ V}$ , $f = 1\text{ MHz}$
$C_D$ (Off)	30			pF typ	$V_S = 0\text{ V}$ , $f = 1\text{ MHz}$
$C_D$ , $C_S$ (On)	100			pF typ	$V_S = 0\text{ V}$ , $f = 1\text{ MHz}$
<b>POWER REQUIREMENTS</b>					
$I_{DD}$	0.001			$\mu\text{A}$ typ	$V_{DD} = 5.5\text{ V}$ , $V_{SS} = -5.5\text{ V}$
			1.0	$\mu\text{A}$ max	Digital inputs = 0 V or $V_{DD}$
$I_{SS}$	0.001			$\mu\text{A}$ typ	Digital inputs = 0 V or $V_{DD}$
			1.0	$\mu\text{A}$ max	
$V_{DD}/V_{SS}$			$\pm 4.5/\pm 16.5$	V min/max	Ground = 0 V

<sup>1</sup> Guaranteed by design, not subject to production test.

**CONTINUOUS CURRENT PER CHANNEL, S OR D**

Table 4.

Parameter	25°C	85°C	125°C	Unit	Test Conditions/Comments
CONTINUOUS CURRENT PER CHANNEL <sup>1</sup>					
±15 V Dual Supply					$V_{DD} = +13.5\text{ V}, V_{SS} = -13.5\text{ V}$
10-Lead MSOP ( $\theta_{JA} = 142^\circ\text{C/W}$ )	185	120	75	mA maximum	
10-Lead LFCSP ( $\theta_{JA} = 76^\circ\text{C/W}$ )	250	155	85	mA maximum	
+12 V Single Supply					$V_{DD} = 10.8\text{ V}, V_{SS} = 0\text{ V}$
10-Lead MSOP ( $\theta_{JA} = 142^\circ\text{C/W}$ )	150	100	65	mA maximum	
10-Lead LFCSP ( $\theta_{JA} = 76^\circ\text{C/W}$ )	205	130	80	mA maximum	
±5 V Dual Supply					$V_{DD} = +4.5\text{ V}, V_{SS} = -4.5\text{ V}$
10-Lead MSOP ( $\theta_{JA} = 142^\circ\text{C/W}$ )	145	100	65	mA maximum	
10-Lead LFCSP ( $\theta_{JA} = 76^\circ\text{C/W}$ )	195	125	75	mA maximum	

<sup>1</sup> Guaranteed by design, not subject to production test.

## ABSOLUTE MAXIMUM RATINGS

$T_A = 25^\circ\text{C}$ , unless otherwise noted.

Table 5.

Parameter	Rating
$V_{DD}$ to $V_{SS}$	35 V
$V_{DD}$ to GND	-0.3 V to +25 V
$V_{SS}$ to GND	+0.3 V to -25 V
Analog Inputs <sup>1</sup>	$V_{SS} - 0.3\text{ V}$ to $V_{DD} + 0.3\text{ V}$ or 30 mA, whichever occurs first
Digital Inputs <sup>1</sup>	GND - 0.3 V to $V_{DD} + 0.3\text{ V}$ or 30 mA, whichever occurs first
Peak Current, S or D (Pulsed at 1 ms, 10% Duty-Cycle Maximum)	
10-Lead MSOP (4-Layer Board)	300 mA
10-Lead LFCSP	400 mA
Continuous Current per Channel, S or D	Data in Table 4 + 15% mA
Operating Temperature Range Industrial	-40°C to +125°C
Storage Temperature Range	-65°C to +150°C
Junction Temperature	150°C
Reflow Soldering Peak Temperature, Pb Free	260°C

<sup>1</sup> Over voltages at IN, S, or D are clamped by internal diodes. Current should be limited to the maximum ratings given.

Stresses above those listed under Absolute Maximum Ratings may cause permanent damage to the device. This is a stress rating only; functional operation of the device at these or any other conditions above those indicated in the operational section of this specification is not implied. Exposure to absolute maximum rating conditions for extended periods may affect device reliability.

## THERMAL RESISTANCE

Table 6. Thermal Resistance

Package Type	$\theta_{JA}$	$\theta_{JC}$	Unit
10-Lead MSOP (4-Layer Board)	142	44	°C/W
10-Lead LFCSP	76		°C/W

## ESD CAUTION



**ESD (electrostatic discharge) sensitive device.** Charged devices and circuit boards can discharge without detection. Although this product features patented or proprietary protection circuitry, damage may occur on devices subjected to high energy ESD. Therefore, proper ESD precautions should be taken to avoid performance degradation or loss of functionality.

PIN CONFIGURATIONS AND FUNCTION DESCRIPTIONS

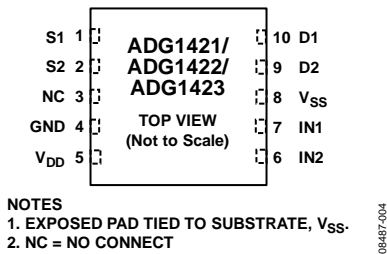

NOTES  
 1. EXPOSED PAD TIED TO SUBSTRATE,  $V_{SS}$ .  
 2. NC = NO CONNECT

Figure 4. 10-Lead LFCSP Pin Configuration

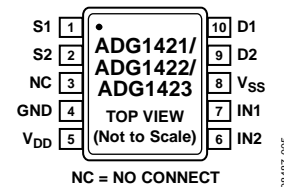

NC = NO CONNECT

Figure 5. 10-Lead MSOP Pin Configuration

Table 7. 10-Lead LFCSP Pin Function Descriptions

Pin No.	Mnemonic	Description
1	S1	Source Terminal. This pin can be an input or output.
2	S2	Source Terminal. This pin can be an input or output.
3	NC	No Connect.
4	GND	Ground (0 V) Reference.
5	$V_{DD}$	Most Positive Power Supply Potential.
6	IN2	Logic Control Input.
7	IN1	Logic Control Input.
8	$V_{SS}$	Most Negative Power Supply Potential.
9	D2	Drain Terminal. This pin can be an input or output.
10	D1	Drain Terminal. This pin can be an input or output.
	EPAD	Exposed pad tied to substrate, $V_{SS}$ .

Table 8. 10-Lead MSOP Pin Function Descriptions

Pin No.	Mnemonic	Description
1	S1	Source Terminal. This pin can be an input or output.
2	S2	Source Terminal. This pin can be an input or output.
3	NC	No Connect.
4	GND	Ground (0 V) Reference.
5	$V_{DD}$	Most Positive Power Supply Potential.
6	IN2	Logic Control Input.
7	IN1	Logic Control Input.
8	$V_{SS}$	Most Negative Power Supply Potential.
9	D2	Drain Terminal. This pin can be an input or output.
10	D1	Drain Terminal. This pin can be an input or output.

Table 9. ADG1421/ADG1422 Truth Table

ADG1421 INx	ADG1422 INx	Switch Condition
1	0	On
0	1	Off

Table 10. ADG1423 Truth Table

ADG1423 INx	Switch 1 Condition	Switch 2 Condition
0	Off	On
1	On	Off



TYPICAL PERFORMANCE CHARACTERISTICS



Figure 6. On Resistance as a Function of  $V_D$  ( $V_S$ ) for Dual Supply

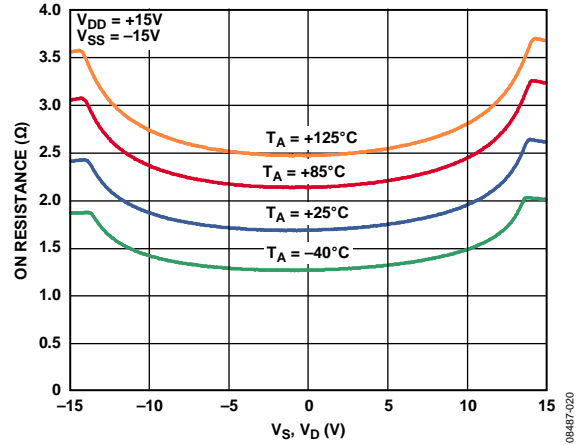

Figure 9. On Resistance as a Function of  $V_D$  ( $V_S$ ) for Different Temperatures,  $\pm 15$  V Dual Supply

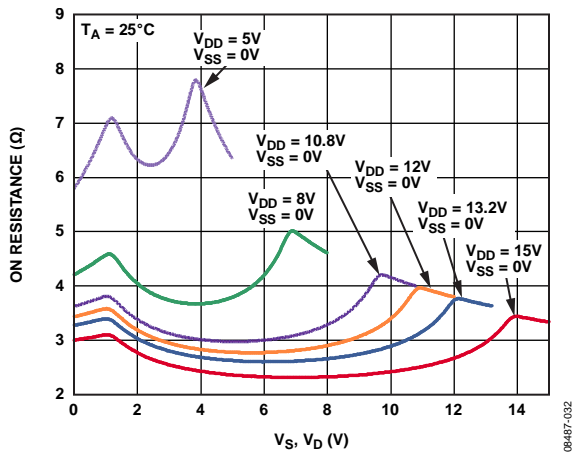

Figure 7. On Resistance as a Function of  $V_D$  ( $V_S$ ) for Single Supply

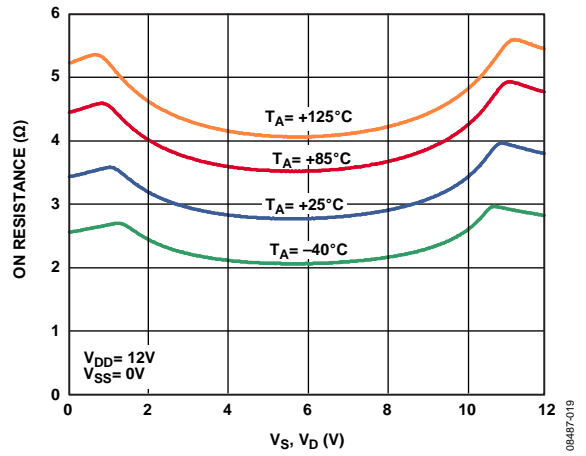

Figure 10. On Resistance as a Function of  $V_D$  ( $V_S$ ) for Different Temperatures, +12 V Single Supply

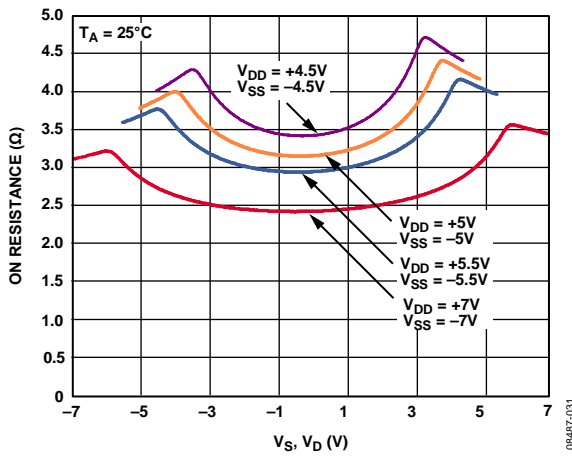

Figure 8. On Resistance as a Function of  $V_D$  ( $V_S$ ) for Dual Supply

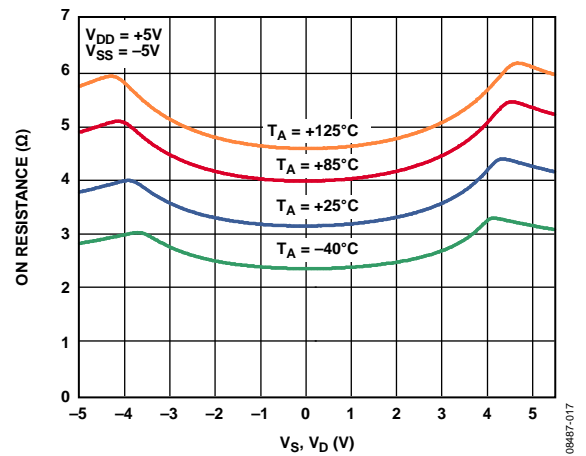

Figure 11. On Resistance as a Function of  $V_D$  ( $V_S$ ) for Different Temperatures,  $\pm 5$  V Dual Supply



Figure 12. Leakage Currents as a Function of Temperature, ±15 V Dual Supply



Figure 15.  $I_{DD}$  vs. Logic Level



Figure 13. Leakage Currents as a Function of Temperature, +12 V Single Supply



Figure 16. Charge Injection vs. Source Voltage



Figure 14. Leakage Currents as a Function of Temperature, ±5 V Dual Supply



Figure 17.  $t_{TRANSITION}$  Times vs. Temperature



Figure 18. Off Isolation vs. Frequency



Figure 21. THD + N vs. Frequency



Figure 19. On Response vs. Frequency



Figure 22. ACPSRR vs. Frequency



Figure 20. Crosstalk vs. Frequency

08487-008

08487-011

08487-007

08487-009

08487-012

TEST CIRCUITS



Figure 23. On Resistance



Figure 25. On Leakage

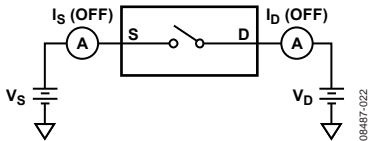

Figure 24. Off Leakage



Figure 26. Switching Times



Figure 27. Break-Before-Make Time Delay



Figure 28. Charge Injection

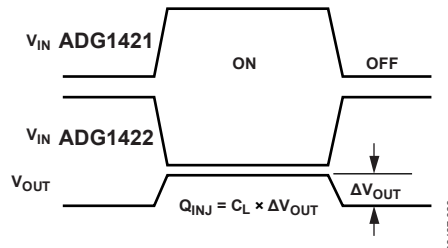



Figure 29. Off Isolation

08487-027

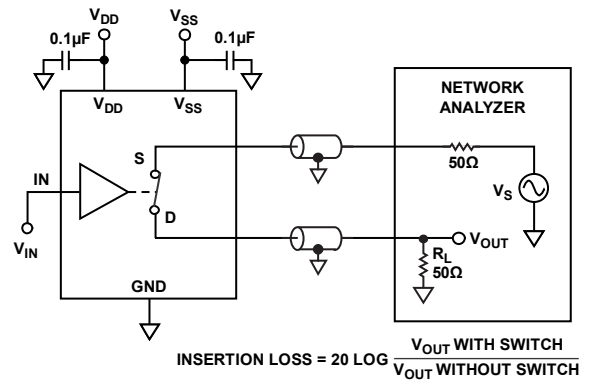

Figure 31. Bandwidth

08487-029

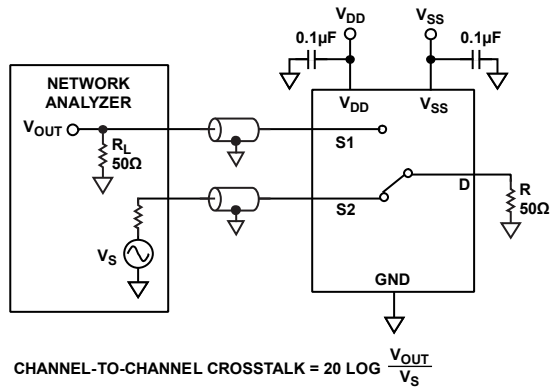

Figure 30. Channel-to-Channel Crosstalk

08487-028

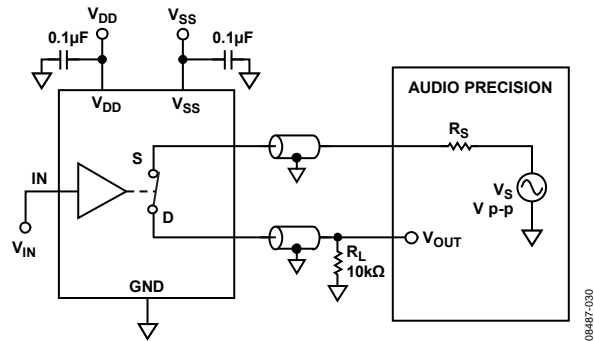

Figure 32. THD + N

08487-030

## TERMINOLOGY

<b>I<sub>DD</sub></b>	The positive supply current.	<b>t<sub>ON</sub> (EN)</b>	Delay time between the 50% and 90% points of the digital input and switch on condition. See Figure 26.
<b>I<sub>SS</sub></b>	The negative supply current.	<b>t<sub>OFF</sub> (EN)</b>	Delay time between the 50% and 90% points of the digital input and switch off condition. See Figure 26.
<b>V<sub>D</sub> (V<sub>S</sub>)</b>	The analog voltage on Terminal D and Terminal S.	<b>t<sub>TRANSITION</sub></b>	Delay time between the 50% and 90% points of the digital inputs and the switch on condition when switching from one address state to another.
<b>R<sub>ON</sub></b>	The ohmic resistance between Terminal D and Terminal S.	<b>T<sub>BBM</sub></b>	Off time measured between the 80% point of both switches when switching from one address state to another. See Figure 27.
<b>R<sub>FLAT</sub> (ON)</b>	Flatness is defined as the difference between the maximum and minimum value of on resistance as measured over the specified analog signal range.	<b>Charge Injection</b>	A measure of the glitch impulse transferred from the digital input to the analog output during switching. See Figure 28.
<b>I<sub>S</sub> (Off)</b>	The source leakage current with the switch off.	<b>Off Isolation</b>	A measure of unwanted signal coupling through an off switch. See Figure 29.
<b>I<sub>D</sub> (Off)</b>	The drain leakage current with the switch off.	<b>Crosstalk</b>	A measure of unwanted signal that is coupled through from one channel to another as a result of parasitic capacitance. See Figure 30.
<b>I<sub>D</sub>, I<sub>S</sub> (On)</b>	The channel leakage current with the switch on.	<b>Bandwidth</b>	The frequency at which the output is attenuated by 3 dB. See Figure 31.
<b>V<sub>INL</sub></b>	The maximum input voltage for Logic 0.	<b>On Response</b>	The frequency response of the on switch.
<b>V<sub>INH</sub></b>	The minimum input voltage for Logic 1.	<b>Insertion Loss</b>	The loss due to the on resistance of the switch. See Figure 31.
<b>I<sub>INL</sub> (I<sub>INH</sub>)</b>	The input current of the digital input.	<b>THD + N</b>	The ratio of the harmonic amplitude plus noise of the signal to the fundamental. See Figure 32.
<b>C<sub>S</sub> (Off)</b>	The off switch source capacitance, measured with reference to ground.	<b>AC Power Supply Rejection Ratio (ACPSRR)</b>	ACPSRR measures the ability of a part to avoid coupling noise and spurious signals that appear on the supply voltage pin to the output of the switch. The dc voltage on the device is modulated by a sine wave of 0.62 V p-p. The ratio of the amplitude of signal on the output to the amplitude of the modulation is the ACPSRR. See Figure 22.
<b>C<sub>D</sub> (Off)</b>	The off switch drain capacitance, measured with reference to ground.		
<b>C<sub>D</sub>, C<sub>S</sub> (On)</b>	The on switch capacitance, measured with reference to ground.		
<b>C<sub>IN</sub></b>	The digital input capacitance.		

OUTLINE DIMENSIONS

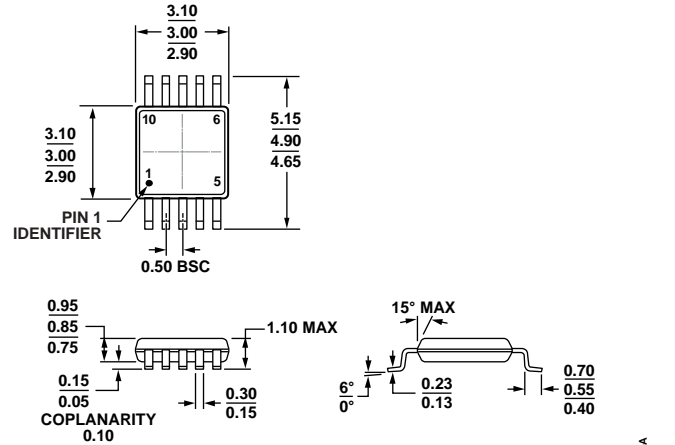

COMPLIANT TO JEDEC STANDARDS MO-187-BA

Figure 33. 10-Lead Mini Small Outline Package [MSOP] (RM-10)  
Dimensions shown in millimeters

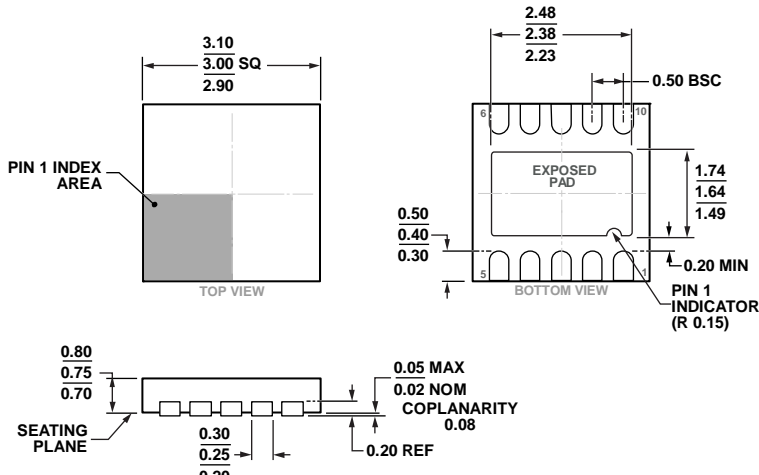

\*FOR PROPER CONNECTION OF THE EXPOSED PAD, REFER TO THE PIN CONFIGURATIONS AND FUNCTION DESCRIPTIONS SECTION OF THIS DATA SHEET.

Figure 34. 10-Lead Lead Frame Chip Scale Package [LFCSP\_WD]  
3 mm x 3 mm Body, Very Very Thin, Dual Lead (CP-10-9)  
Dimensions shown in millimeters

## ORDERING GUIDE

Model <sup>1</sup>	Temperature Range	Package Description	Package Option	Branding
ADG1421BRMZ	-40°C to +125°C	10-Lead Mini Small Outline Package [MSOP]	RM-10	S2V
ADG1421BRMZ-REEL7	-40°C to +125°C	10-Lead Mini Small Outline Package [MSOP]	RM-10	S2V
ADG1421BCPZ-REEL7	-40°C to +125°C	10- Lead Frame Chip Scale Package [LFCSP_WD]	CP-10-9	S2V
ADG1422BRMZ	-40°C to +125°C	10-Lead Mini Small Outline Package [MSOP]	RM-10	S2W
ADG1422BRMZ-REEL7	-40°C to +125°C	10-Lead Mini Small Outline Package [MSOP]	RM-10	S2W
ADG1422BCPZ-REEL7	-40°C to +125°C	10- Lead Frame Chip Scale Package [LFCSP_WD]	CP-10-9	S2W
ADG1423BRMZ	-40°C to +125°C	10-Lead Mini Small Outline Package [MSOP]	RM-10	S2X
ADG1423BRMZ-REEL7	-40°C to +125°C	10-Lead Mini Small Outline Package [MSOP]	RM-10	S2X
ADG1423BCPZ-REEL7	-40°C to +125°C	10- Lead Frame Chip Scale Package [LFCSP_WD]	CP-10-9	S2X

<sup>1</sup> Z = RoHS Compliant Part.





Компания «ЭлектроПласт» предлагает заключение долгосрочных отношений при поставках импортных электронных компонентов на взаимовыгодных условиях!

Наши преимущества:

- Оперативные поставки широкого спектра электронных компонентов отечественного и импортного производства напрямую от производителей и с крупнейших мировых складов;
- Поставка более 17-ти миллионов наименований электронных компонентов;
- Поставка сложных, дефицитных, либо снятых с производства позиций;
- Оперативные сроки поставки под заказ (от 5 рабочих дней);
- Экспресс доставка в любую точку России;
- Техническая поддержка проекта, помощь в подборе аналогов, поставка прототипов;
- Система менеджмента качества сертифицирована по Международному стандарту ISO 9001;
- Лицензия ФСБ на осуществление работ с использованием сведений, составляющих государственную тайну;
- Поставка специализированных компонентов (Xilinx, Altera, Analog Devices, Intersil, Interpoint, Microsemi, Aeroflex, Peregrine, Syfer, Eurofarad, Texas Instrument, Miteq, Cobham, E2V, MA-COM, Hittite, Mini-Circuits, General Dynamics и др.);

Помимо этого, одним из направлений компании «ЭлектроПласт» является направление «Источники питания». Мы предлагаем Вам помощь Конструкторского отдела:

- Подбор оптимального решения, техническое обоснование при выборе компонента;
- Подбор аналогов;
- Консультации по применению компонента;
- Поставка образцов и прототипов;
- Техническая поддержка проекта;
- Защита от снятия компонента с производства.



#### Как с нами связаться

**Телефон:** 8 (812) 309 58 32 (многоканальный)

**Факс:** 8 (812) 320-02-42

**Электронная почта:** [org@eplast1.ru](mailto:org@eplast1.ru)

**Адрес:** 198099, г. Санкт-Петербург, ул. Калинина, дом 2, корпус 4, литера А.