

# KX14/15 SERIES CONNECTORS

## 0.8mm (.031") Contact Spacing, PCB-to-PCB SMT Connectors



### FEATURES

- 0.8mm (.031") contact spacing
- Straight receptacle (KX14) and right angle/straight plug (KX15) for paralleled and vertical PCB connections
- 4 to 18mm (.157 to .709") stacking heights
- Polarization key prevents mismatching
- Resistant to vibration and twisting
- Available in embossed tape for automatic mounting

Connector Profile (Ref.)

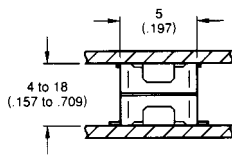

Hold-down type (Right-angle side)

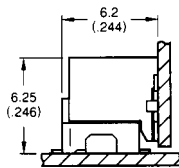

Screw type (Right-angle side)

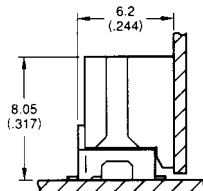

The KX14/15 Series connectors are low profile, SMT type connectors for PCB-to-PCB applications. Contact spacing is 0.8mm (.031"). The receptacle (KX14) and plug (KX15) combination offer variable stacking heights of 4 to 18mm (.157 to .709").

These connectors are ideal for use in the personal computer industry where space, weight and high density are critical factors.

### GENERAL SPECIFICATIONS

Number of Contacts	20, 30, 40, 50, 60, 70, 80, 100, 120, 140, 160, 200 (See Note 1)
Contact Spacing	0.8mm (.031")
Current Rating	0.5 Amps
Dielectric Withstanding Voltage	500 VAC r.m.s. (for one minute)
Insulation Resistance	100 megohms min.
Contact Resistance	70 milliohms max.
Operating Temperature	-40°C to +85°C

Note 1: Please consult JAE for availability.

### MATERIALS AND FINISHES

Description	Materials/Finishes
Insulator KX14 KX15 Straight KX15 Right Angle	Glass-filled LCP/Black Glass-filled PPS/Black Glass-filled LCP/Black
Contact	Copper Alloy Connecting Area: 0.1µm (.000004") min. Gold Plating Over Nickel Terminal Area: Gold flash over Nickel or Tin-lead over Nickel
Hold Down	Copper Alloy/Tin-lead over Nickel
Hook Pin	Copper Alloy/Tin plating
Hexagon Nut	Brass/Nickel plating

Dimensions and specifications subject to change without notice.



# KX14/15 SERIES CONNECTORS

0.8mm (.031") Contact Spacing, PCB-to-PCB SMT Connectors

## ORDERING INFORMATION

### STRAIGHT

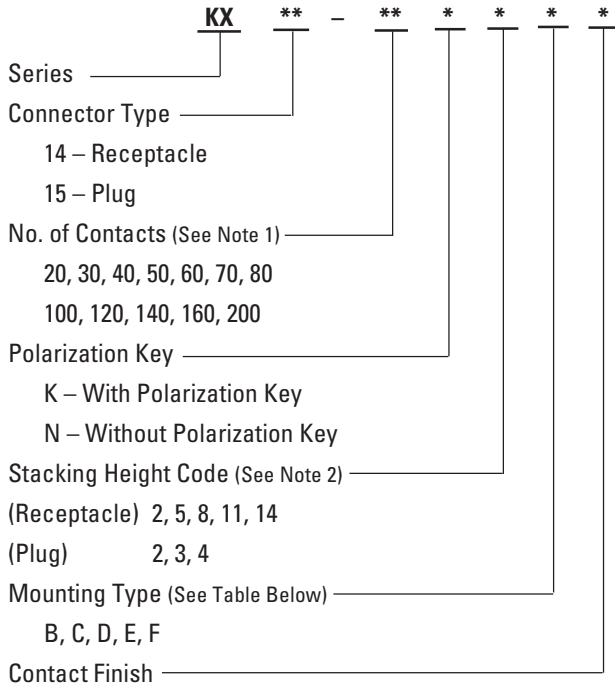

Blank – Connecting Area: Gold plating 0.1µm (.000004") min. over Nickel  
Terminal Area: Gold Flash over Nickel

1 – Connecting Area: Gold plating 0.1µm (.000004") min. over Nickel  
Terminal Area: Tin-Lead over Nickel

Note 1: Please consult JAE for availability.  
Note 2: Stacking Height = Stacking Height Code of KX14 & Stacking Height Code of KX15.

### Mounting Type for Straight

	Positioning Key	Hold Down	Flange	Hook Pin
B	○	—	—	—
C	○	—	○	○
D	○	○	○	—
E	○	—	○	—
F	—	○	○	—

### RIGHT ANGLE

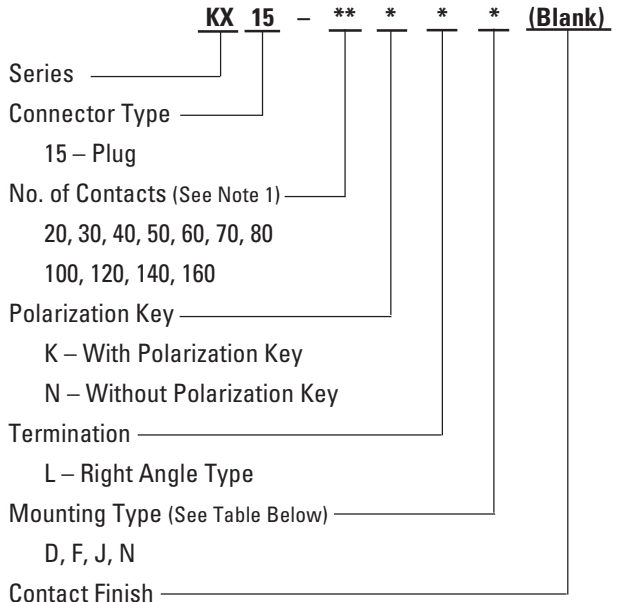

Blank – Connecting Area: Gold plating 0.1µm (.000004") min. over Nickel  
Terminal Area: Gold Flash over Nickel

Note 1: Please consult JAE for availability.

### Mounting Type for Right Angle

	Positioning Key	Hold Down	Nut
D	○	○	—
F	—	○	—
J	○	—	—
N	○	—	○

### Stacking Height (Parallel PCB to PCB connection)

		Plug			
		Stacking Height Code	2	3	4
Receptacle	2	4 (.157)	5 (.197)	6 (.236)	
	5	7 (.276)	8 (.315)	9 (.354)	
	8	10 (.394)	11 (.433)	12 (.472)	
	11	13 (.512)	14 (.551)	15 (.591)	
	14	16 (.630)	17 (.669)	18 (.709)	

Dimensions in mm (inches).

# KX14/15 SERIES CONNECTORS

## 0.8mm (.031") Contact Spacing, PCB-to-PCB SMT Connectors

### KX14 • STRAIGHT RECEPTACLE

Note 1: Shown below is mounting type D with polarization key.

Note 2: Mounting side configuration for 200 contacts is different. Please consult JAE.



Dimension X and Y

Stacking Height Code	X	Y
2	0.75 (.030)	3.55 (.140)
5	3.75 (.148)	6.55 (.258)
8	6.75 (.266)	9.55 (.376)
11	9.75 (.384)	12.55 (.494)
14	12.75 (.502)	15.55 (.612)



Applicable PCB Dimension (Ref.)

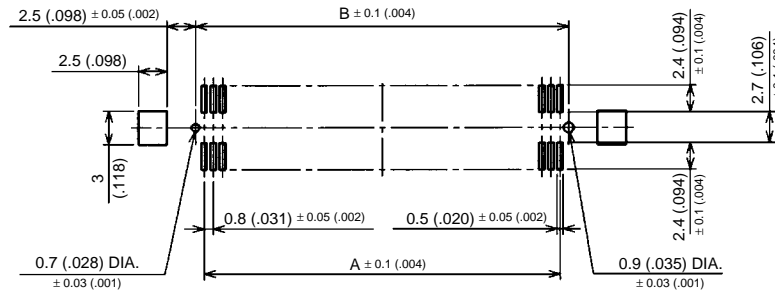

No. of Contacts	Part Number (Note 1)		A	B	C	D
	With Polarization Key	Without Polarization Key				
20	KX14- 20K□*+	KX14- 20N□*+	7.2 (.283)	8.7 (.342)	12.3 (.484)	16 (.630)
30	KX14- 30K□*+	KX14- 30N□*+	11.2 (.441)	12.7 (.500)	16.3 (.642)	20 (.787)
40	KX14- 40K□*+	KX14- 40N□*+	15.2 (.598)	16.7 (.657)	20.3 (.799)	24 (.945)
50	KX14- 50K□*+	KX14- 50N□*+	19.2 (.756)	20.7 (.815)	24.3 (.957)	28 (1.102)
60	KX14- 60K□*+	KX14- 60N□*+	23.2 (.913)	24.7 (.972)	28.3 (1.114)	32 (1.260)
70	KX14- 70K□*+	KX14- 70N□*+	27.2 (1.071)	28.7 (1.130)	32.3 (1.272)	36 (1.417)
80	KX14- 80K□*+	KX14- 80N□*+	31.2 (1.228)	32.7 (1.287)	36.3 (1.429)	40 (1.575)
100	KX14- 100K□*+	KX14- 100N□*+	39.2 (1.543)	40.7 (1.602)	44.3 (1.744)	48 (1.890)
120	KX14- 120K□*+	KX14- 120N□*+	47.2 (1.858)	48.7 (1.917)	52.3 (2.059)	56 (2.205)
140	KX14- 140K□*+	KX14- 140N□*+	55.2 (2.173)	56.7 (2.232)	60.3 (2.374)	64 (2.520)
160	KX14- 160K□*+	KX14- 160N□*+	63.2 (2.488)	64.7 (2.547)	68.3 (2.689)	72 (2.835)
200	KX14- 200K□*+	KX14- 200N□*+	80.8 (3.181)	82.3 (3.240)	85.85 (3.380)	89.6 (3.528)

Note 1: □ – Add stacking height code 2, 5, 8, 11 or 14.

+ – Add contact finish code 1 or blank.

Note 2: Please consult JAE for availability.

\* – Add mounting type code B, C, D, E or F.

Refer to Mounting and Stacking Height Tables.

Dimensions in mm (inches).



# KX14/15 SERIES CONNECTORS

## 0.8mm (.031") Contact Spacing, PCB-to-PCB SMT Connectors

### KX15 • STRAIGHT PLUG

Note 1: Shown below is mounting type D with polarization key.

Note 2: Mounting side configuration for 200 contacts is different. Please consult JAE.

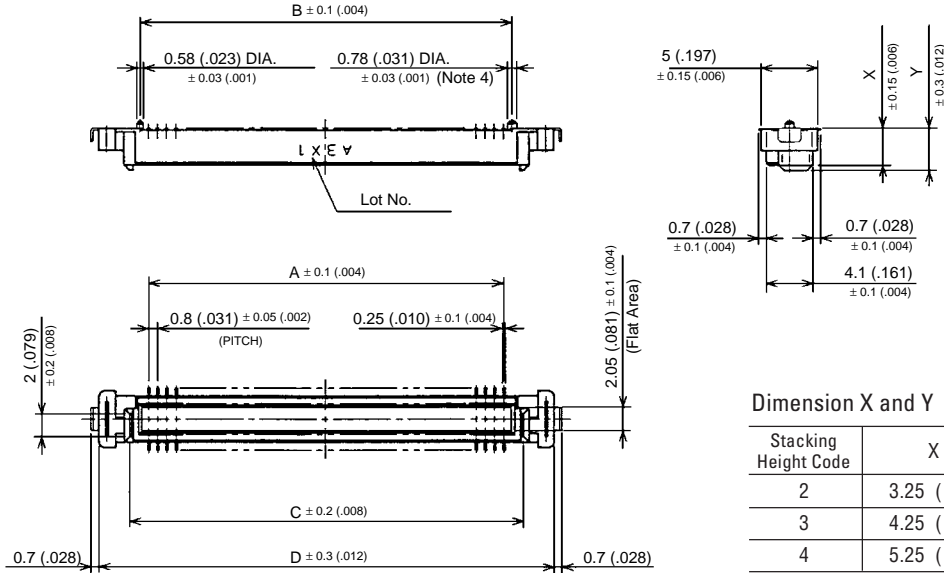

### Applicable PCB Dimension (Ref.)

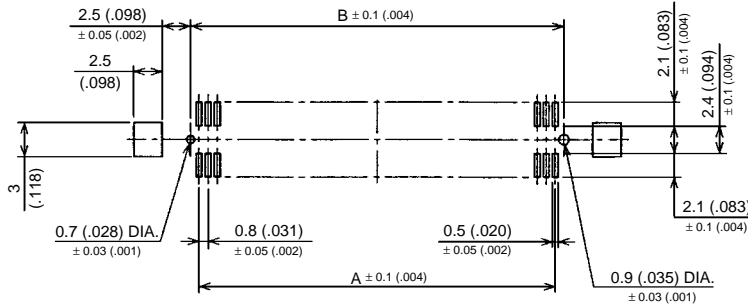

No. of Contacts	Part Number (Note 1)		A	B	C	D
	With Polarization Key	Without Polarization Key				
20	KX15- 20K□*+	KX15- 20N□*+	7.2 (.283)	8.7 (.342)	10.6 (.417)	16 (.630)
30	KX15- 30K□*+	KX15- 30N□*+	11.2 (.441)	12.7 (.500)	14.6 (.575)	20 (.787)
40	KX15- 40K□*+	KX15- 40N□*+	15.2 (.598)	16.7 (.657)	18.6 (.732)	24 (.945)
50	KX15- 50K□*+	KX15- 50N□*+	19.2 (.756)	20.7 (.815)	22.6 (.890)	28 (1.102)
60	KX15- 60K□*+	KX15- 60N□*+	23.2 (.913)	24.7 (.972)	26.6 (1.047)	32 (1.260)
70	KX15- 70K□*+	KX15- 70N□*+	27.2 (1.071)	28.7 (1.130)	30.6 (1.205)	36 (1.417)
80	KX15- 80K□*+	KX15- 80N□*+	31.2 (1.228)	32.7 (1.287)	34.6 (1.362)	40 (1.575)
100	KX15- 100K□*+	KX15- 100N□*+	39.2 (1.543)	40.7 (1.602)	42.6 (1.677)	48 (1.890)
120	KX15- 120K□*+	KX15- 120N□*+	47.2 (1.858)	48.7 (1.917)	50.6 (1.992)	56 (2.205)
140	KX15- 140K□*+	KX15- 140N□*+	55.2 (2.173)	56.7 (2.232)	58.6 (2.307)	64 (2.520)
160	KX15- 160K□*+	KX15- 160N□*+	63.2 (2.488)	64.7 (2.547)	66.6 (2.622)	72 (2.835)
200	KX15- 200K□*+	KX15- 200N□*+	80.8 (3.181)	82.3 (3.240)	84.2 (3.315)	89.6 (3.528)

Note 1: □ – Add stacking height code 2, 3, or 4.

+ – Add contact finish code 1 or blank.

\* – Add mounting type code B, C, D, E or F.

Refer to Mounting and Stacking Height Tables.

Note 2: Please consult JAE for availability.

Dimensions in mm (inches).

# KX14/15 SERIES CONNECTORS

## 0.8mm (.031") Contact Spacing, PCB-to-PCB SMT Connectors

### KX15 • RIGHT ANGLE PLUG

Note: Shown below is mounting type D with polarization key.



### Applicable PCB Dimension (Ref.)

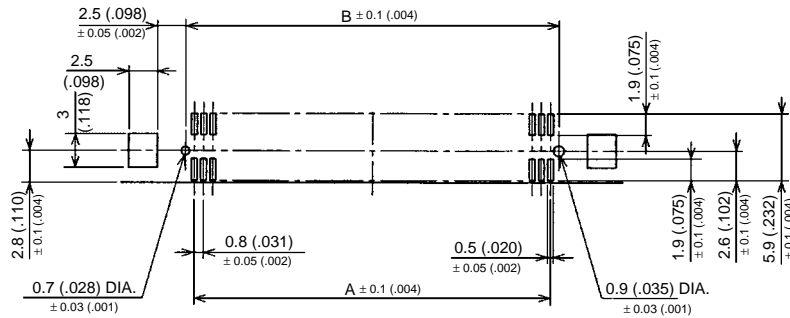

No. of Contacts	Part Number (Note 1)		A	B	C	D
	With Polarization Key	Without Polarization Key				
20	KX15- 20KL *	KX15- 20NL *	7.2 ( .283)	8.7 ( .342)	10.3 ( .406)	16 ( .630)
30	KX15- 30KL *	KX15- 30NL *	11.2 ( .441)	12.7 ( .500)	14.3 ( .563)	20 ( .787)
40	KX15- 40KL *	KX15- 40NL *	15.2 ( .598)	16.7 ( .657)	18.3 ( .720)	24 ( .945)
50	KX15- 50KL *	KX15- 50NL *	19.2 ( .756)	20.7 ( .815)	22.3 ( .878)	28 (1.102)
60	KX15- 60KL *	KX15- 60NL *	23.2 ( .913)	24.7 ( .972)	26.3 (1.035)	32 (1.260)
70	KX15- 70KL *	KX15- 70NL *	27.2 (1.071)	28.7 (1.130)	30.3 (1.193)	36 (1.417)
80	KX15- 80KL *	KX15- 80NL *	31.2 (1.228)	32.7 (1.287)	34.3 (1.350)	40 (1.575)
100	KX15-100KL *	KX15-100NL *	39.2 (1.543)	40.7 (1.602)	42.3 (1.665)	48 (1.890)
120	KX15-120KL *	KX15-120NL *	47.2 (1.858)	48.7 (1.917)	50.3 (1.980)	56 (2.205)
140	KX15-140KL *	KX15-140NL *	55.2 (2.173)	56.7 (2.232)	58.3 (2.295)	64 (2.520)
160	KX15-160KL *	KX15-160NL *	63.2 (2.488)	64.7 (2.547)	66.3 (2.610)	72 (2.835)

Note 1: \* – Add mounting type code D, F, J or N. Refer to Mounting and Stacking Height Tables.

Note 2: Please consult JAE for availability.

Dimensions in mm (inches).





Компания «ЭлектроПласт» предлагает заключение долгосрочных отношений при поставках импортных электронных компонентов на взаимовыгодных условиях!

Наши преимущества:

- Оперативные поставки широкого спектра электронных компонентов отечественного и импортного производства напрямую от производителей и с крупнейших мировых складов;
- Поставка более 17-ти миллионов наименований электронных компонентов;
- Поставка сложных, дефицитных, либо снятых с производства позиций;
- Оперативные сроки поставки под заказ (от 5 рабочих дней);
- Экспресс доставка в любую точку России;
- Техническая поддержка проекта, помощь в подборе аналогов, поставка прототипов;
- Система менеджмента качества сертифицирована по Международному стандарту ISO 9001;
- Лицензия ФСБ на осуществление работ с использованием сведений, составляющих государственную тайну;
- Поставка специализированных компонентов (Xilinx, Altera, Analog Devices, Intersil, Interpoint, Microsemi, Aeroflex, Peregrine, Syfer, Eurofarad, Texas Instrument, Miteq, Cobham, E2V, MA-COM, Hittite, Mini-Circuits, General Dynamics и др.);

Помимо этого, одним из направлений компании «ЭлектроПласт» является направление «Источники питания». Мы предлагаем Вам помощь Конструкторского отдела:

- Подбор оптимального решения, техническое обоснование при выборе компонента;
- Подбор аналогов;
- Консультации по применению компонента;
- Поставка образцов и прототипов;
- Техническая поддержка проекта;
- Защита от снятия компонента с производства.



#### Как с нами связаться

**Телефон:** 8 (812) 309 58 32 (многоканальный)

**Факс:** 8 (812) 320-02-42

**Электронная почта:** [org@eplast1.ru](mailto:org@eplast1.ru)

**Адрес:** 198099, г. Санкт-Петербург, ул. Калинина, дом 2, корпус 4, литера А.