



6

Index

Series 61

| | | |
|----------------|--|-----------------|
| | Description | Page 109 |
| | Product Assembly | Page 110 |
| | Product Range | |
| | - pushbuttons for standard mounting | Page 111 |
| | - pushbuttons for flush mounting | Page 117 |
| | - accessories / spare parts | Page 123 |
| | Technical Data | Page 137 |
| | Technical Drawing / Dimension / Layouts | Page 140 |
| | Circuit Drawing | Page 150 |
| | Typical Applications | Page 151 |
| Marking | Page 153 | |

General Notes

The indicators, illuminated pushbuttons, selector switches, keylock switches and emergency stop switches with spray-water protection at the front (IP 65) are modular and consist of an actuator and switching element. In addition to the standard switching elements (gold-plated silver contact with universal soldering or plug-in terminals), forced-opening, slow-make switching elements with gold or silver contacts and soldering or plug-in terminals are available. They can be supplied with screw terminals and silver contacts too. The front dimensions of the units in this series are 24 x 24 mm, 24 mm dia., 18 x 24 mm, 18 x 18 mm or 18 mm dia. For flush mounting the dimensions 25 mm dia., 24 x 30 mm and 24 x 24 mm can be supplied.

Mounting

All switch actuators are mounted from the front by pushing them through the mounting hole in the front panel. They are then fixed from the back with a fixing nut and the mounting tool typ no. 01-907. Max. tightening torque 50 Ncm. For mounting dimensions and grid size see as of page 145.

The preassembled switching element with the connecting wires in a single plane can be clipped on afterwards. For block or series mounting aids are available.

For switching elements with 2.8 mm plug-in terminals, we offer plug-in bases, which when soldered to a PCB enable a plug-in connection to the button. All actuators are provided with an anti-rotation device.

Lenses

The flat or concave lenses are available in various colours and a transparent or translucent version. The lens surface is non-reflecting (matt). Lenses 19.7 mm dia. can be supplied also in aluminium.

Marking

For engraving, hot stamping and film inserts, see page 153 under "Marking".

Illumination

The midget-grooved T 1 3/4 incandescent lamp (6-60 V, 1.2 W) ensures perfect illumination of the lenses, which are supplied in various colours.

Midget-grooved T 1 3/4 Multi-LED (6, 12, 24, 48 V) are also available in white, red, yellow and green.

For supply voltages above 60 V, it is necessary to use a voltage reduction element (external series resistor, capacitor or transformer). Do not solder the terminals directly, because of the high surface temperature.

Position indication

When the switch with maintained action is actuated, the lens snaps into place mechanically. The position of contacts can always be determined by the position of the lens.

Keylock switch

Standard lock (index D)

1 standard number 311. If the lock number is not specified, we will supply no. 311. An additional 134 special locks (index X) are available on request. Master keys for locks no. 311 - 445 may be ordered by quoting no. 31-989.300.

Two keys are supplied with each keylock switch.

Spare keys for DOM standard locks may be ordered by quoting no. 31-989 (please state the lock number).

Emergency stop switch foolproof with key to unlock

Kaba safety lock. Standard lock number is 1001. Locks with other numbers are available on request.

Spare keys for KABA locks may be ordered under no. 14-987 (please state the lock number).

Specimen order

Indicator complete

- indicator complete, soldering terminal, 18 x 24 mm 61-0030.02

Recommended accessories:

- lens plastic, 18 x 24 mm, clear 61-9331.7
- LED, 6 chips, 6 VDC, yellow 10-5306.3254

illuminated-/pushbutton



- 1 lens
- 2 actuator case
- 3 fixing nut
- 4 switching element

illuminated-/pushbutton for flush mounting

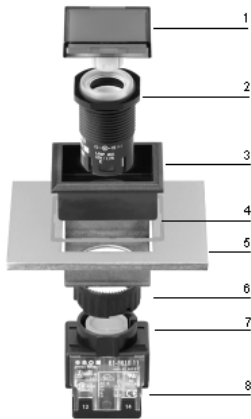









- 1 lens
- 2 actuator housing
- 3 front bezel
- 4 sealing
- 5 front panel
- 6 fixing bow
- 7 fixing nut
- 8 switching element

indicator complete



recommended accessories:

-  lens plastic → 123
-  front ring → 126
-  incandescent lamp → 132; LED → 133

| | connection method |  |  |  |  |  | circuit drawing | technical drawing | mounting dimension |  |
|---------------------------|-------------------|---|---|---|---|---|-----------------|-------------------|--------------------|---|
| indicator complete | ST/PT | 61-0030.02 18 x 24 mm part no. | 61-0050.02 24 x 24 mm part no. | 61-0010.02 18 mm dia. part no. | 61-0020.02 18 x 18 mm part no. | 61-0040.02 24 mm dia. part no. | 1 | 1 | 1 | 0,005 |

connection method: ST/PT = soldering-/plug-in terminal

Accessorie front ring only requested for Ø 24 mm.





marking see page 153







technical drawing as of page 140, mounting dimensions as of page 145, circuit drawing as of page 150

indicator-/flasher-actuator



recommended accessories:

-  lens plastic → 123
-  front ring → 126
-  incandescent lamp → 132; LED → 133
-  lamp element → 128; diode element → 128; flasher element → 131

| |  |  |  |  |  | circuit drawing | technical drawing | mounting dimension |  |
|------------------------------------|---|---|---|---|---|-----------------|-------------------|--------------------|---|
| indicator-/flasher-actuator | 61-0039.0 18 x 24 mm part no. | 61-0059.0 24 x 24 mm part no. | 61-0019.0 18 mm dia. part no. | 61-0029.0 18 x 18 mm part no. | 61-0049.0 24 mm dia. part no. | 1 | 2 | 1 | 0,005 |

Accessorie front ring only requested for Ø 24 mm.

marking see page 153

technical drawing as of page 140, mounting dimensions as of page 145, circuit drawing as of page 150

illuminated-/pushbutton actuator



recommended accessories:

- lens plastic → 123; lens metal with window → 124; lens metal → 124
- front ring → 126
- incandescent lamp → 132; LED → 133
- switching element for illuminated-/pushbutton, keylock-/selector switch 2 positions → 129

| | switching action | 18 x 24 mm part no. | 24 x 24 mm part no. | 18 mm dia. part no. | 18 x 18 mm part no. | 24 mm dia. part no. | circuit drawing | technical drawing | mounting dimension | |
|---|------------------|---------------------|---------------------|---------------------|---------------------|---------------------|-----------------|-------------------|--------------------|-------|
| illuminated-/pushbutton actuator | main | 61-1230.0 | 61-1250.0 | 61-1210.0 | 61-1220.0 | 61-1240.0 | 2 | 3 | 1 | 0,005 |
| | mom | 61-1130.0 | 61-1150.0 | 61-1110.0 | 61-1120.0 | 61-1140.0 | 3 | 3 | 1 | 0,005 |
| | mom/main | 61-1330.0 | 61-1350.0 | 61-1310.0 | 61-1320.0 | | 3 | 3 | 1 | 0,005 |

switching action: main = maintained action, mom = momentary action, mom/main = momentary-/maintained action

Accessorie front ring only requested for Ø 24 mm.

marking see page 153

[technical drawing as of page 140](#), [mounting dimensions as of page 145](#), [circuit drawing as of page 150](#)

emergency stop switch actuator foolproof

according to EN 418



recommended accessories:

- label for emergency stop switch → 134
- switching element for emergency stop switch → 130
- protective shroud for emergency stop switch → 134

| | switching action | unlocking | marking of mushroom-head cap | 27 mm dia. part no. | circuit drawing | technical drawing | mounting dimension | |
|---|------------------|------------------|------------------------------|---------------------|-----------------|-------------------|--------------------|-------|
| emergency stop switch actuator foolproof | main | twist to release | arrows | 61-3440.4/1 | 4 | 4 | 2 | 0,003 |
| | | | stop | 61-3440.4/2 | 4 | 4 | 2 | 0,003 |
| without label standard lock1001, other lock numbers on request | main | key to release | stop | 61-5441.4/K | 4 | 4 | 2 | 0,038 |

switching action: main = maintained action

description see page 109

[technical drawing as of page 140](#), [mounting dimensions as of page 145](#), [circuit drawing as of page 150](#)

pushbutton actuator with mushroom-head cap



recommended accessories:

-  mushroom-head cap → 124
-  front ring → 126
-  switching element for illuminated-/pushbutton, keylock-/selector switch 2 positions → 129

| | switching action | 32 mm dia. part no. | circuit drawing | technical drawing | mounting dimension | |
|---|------------------|---------------------|-----------------|-------------------|--------------------|-------|
| pushbutton actuator with mushroom-head cap | main | 61-1240.0 | 2 | 5 | 2 | 0,006 |
| | mom | 61-1140.0 | 3 | 5 | 2 | 0,006 |

switching action: main = maintained action, mom = momentary action



technical drawing as of page 140, mounting dimensions as of page 145, circuit drawing as of page 150



keylock switch actuator 2 positions

if installed with anti-twist device, the lug is on the left.

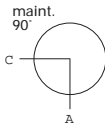

recommended accessories:

-  keylock front bezel → 124
-  switching element for illuminated-/pushbutton, keylock-/selector switch 2 positions → 129
-  anti-twisting ring → 135

| | switching action | key removable in | part no. | circuit drawing | technical drawing | mounting dimension | |
|---|------------------|------------------|--------------------|-----------------|-------------------|--------------------|-------|
|   <p>keylock switch actuator 2 positions pos. A: basic position pos. C: maintained action standard lock 311, other lock numbers on request</p> | main | A | 61-2201.0/D | 6 | 6 | 1 | 0,003 |
| | | C | 61-2203.0/D | 6 | 6 | 1 | 0,003 |
| | | C + A | 61-2205.0/D | 6 | 6 | 1 | 0,003 |
| pos. A: basic position pos. C: momentary action standard lock 311, other lock numbers on request | mom | A | 61-2101.0/D | 5 | 6 | 1 | 0,003 |

switching action: main = maintained action, mom = momentary action

description see page 109

technical drawing as of page 140, mounting dimensions as of page 145, circuit drawing as of page 150

keylock switch actuator 3 positions

if installed with anti-twist device, the lug is on the left.



recommended accessories:

- keylock front bezel → 124
- switching element for keylock-/selector switch 3 positions → 130
- anti-twisting ring → 135

| | switching action | key removable in | part no. | circuit drawing | technical drawing | mounting dimension | kg |
|--|------------------|------------------|--------------------|-----------------|-------------------|--------------------|-------|
| | | | | | | | |
| keylock switch actuator 3 positions pos. C: maintained action pos. A: basic position pos. B: maintained action standard lock 311 other lock numbers on request | main-0-main | A | 61-2601.0/D | 11 | 6 | 1 | 0,003 |
| | | A+B | 61-2604.0/D | 11 | 6 | 1 | 0,003 |
| | | B | 61-2602.0/D | 11 | 6 | 1 | 0,003 |
| | | C | 61-2603.0/D | 11 | 6 | 1 | 0,003 |
| | | C + A | 61-2605.0/D | 11 | 6 | 1 | 0,003 |
| | | C+A+B | 61-2607.0/D | 11 | 6 | 1 | 0,003 |
| | | C+B | 61-2606.0/D | 11 | 6 | 1 | 0,003 |
| pos. C: maintained action pos. A: basic position pos. B: momentary action standard lock 311 other lock numbers on request | main-0-mom | A | 61-2701.0/D | 10 | 6 | 1 | 0,003 |
| | | C | 61-2703.0/D | 10 | 6 | 1 | 0,003 |
| | | C + A | 61-2705.0/D | 10 | 6 | 1 | 0,003 |
| pos. C: momentary action pos. A: basic position pos. B: maintained action standard lock 311 | mom-0-main | A | 61-2801.0/D | 9 | 6 | 1 | 0,003 |
| | | A+B | 61-2804.0/D | 9 | 6 | 1 | 0,003 |
| | | B | 61-2802.0/D | 7 | 6 | 1 | 0,003 |
| pos. C: momentary action pos. A: basic position pos. B: momentary action standard lock 311 | mom-0-mom | A | 61-2501.0/D | 8 | 6 | 1 | 0,003 |

switching action: mom = momentary action, main = maintained action, 0 = basic position

[description see page 109](#)

[technical drawing as of page 140, mounting dimensions as of page 145, circuit drawing as of page 150](#)

selector switch actuator 2 positions

if installed with anti-twist device, the lug is on the left.



recommended accessories:

-  lever → 125
-  incandescent lamp → 132; LED → 133
-  switching element for illuminated-/pushbutton, keylock-/selector switch 2 positions → 129
-  anti-twisting ring → 135



| | switching action | 18 mm dia. part no. | circuit drawing | technical drawing | mounting dimension |  |
|--|------------------|---------------------|-----------------|-------------------|--------------------|---|
| selector switch actuator 2 positions pos. C: maintained action pos. A: basic position | main | 61-4210.0 | 13 | 7 | 1 | 0,006 |
| pos. C: momentary action pos. A: basic position | mom | 61-4110.0 | 12 | 7 | 1 | 0,006 |

switching action: main = maintained action, mom = momentary action

technical drawing as of page 140, mounting dimensions as of page 145, circuit drawing as of page 150

selector switch actuator 3 positions

if installed with anti-twist device, the lug is on the left.



recommended accessories:

-  lever → 125
-  incandescent lamp → 132; LED → 133
-  switching element for keylock-/selector switch 3 positions → 130
-  anti-twisting ring → 135

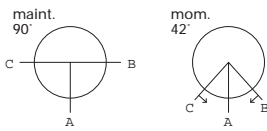

| | switching action | 18 mm dia. part no. | circuit drawing | technical drawing | mounting dimension |  |
|---|------------------|------------------------|-----------------|-------------------|--------------------|---|
| selector switch actuator 3 positions pos. C: maintained action pos. A: basic position pos. B: maintained action | main-0-main | 61-4610.0 | 17 | 7 | 1 | 0,006 |
| pos. C: maintained action pos. A: basic position pos. B: momentary action | main-0-mom | 61-4710.0 | 16 | 7 | 1 | 0,006 |
| pos. C: momentary action pos. A: basic position pos. B: maintained action | mom-0-main | 61-4810.0 | 15 | 7 | 1 | 0,006 |
| pos. C: momentary action pos. A: basic position pos. B: momentary action | mom-0-mom | 61-4510.0 | 14 | 7 | 1 | 0,006 |

switching action: mom = momentary, main = maintaining, 0 = basic position

technical drawing as of page 140. mounting dimensions as of page 145. circuit drawing as of page 150

indicator complete for flush mounting



recommended accessories:

-  lens plastic for flush mounting → 124
-  front bezel-set for flush mounting → 126
-  incandescent lamp → 132; LED → 133

| | connection method | part no. | circuit drawing | technical drawing | mounting dimension |  |
|--|-------------------|-------------------|-----------------|-------------------|--------------------|---|
| indicator complete for flush mounting | ST/PT | 61-0000.02 | 1 | 8 | 3 | 0,006 |

connection method: ST/PT = soldering-/plug-in terminal

marking see page 153

technical drawing as of page 140, mounting dimensions as of page 145, circuit drawing as of page 150

indicator-/flasher-actuator for flush mounting



recommended accessories:

-  lens plastic for flush mounting → 124
-  front bezel-set for flush mounting → 126
-  incandescent lamp → 132; LED → 133
-  lamp element → 128; diode element → 128; flasher element → 131

| | part no. | circuit drawing | technical drawing | mounting dimension |  |
|---|------------------|-----------------|-------------------|--------------------|---|
| indicator-/flasher-actuator for flush mounting | 61-0009.0 | 1 | 9 | 3 | 0,005 |





marking see page 153

technical drawing as of page 140, mounting dimensions as of page 145, circuit drawing as of page 150

illuminated-/pushbutton actuator for flush mounting



recommended accessories:

-  lens plastic for flush mounting → 124; lens metal with window → 124; lens metal → 124
-  front bezel-set for flush mounting → 126
-  incandescent lamp → 132; LED → 133
-  switching element for illuminated-/pushbutton, keylock-/selector switch 2 positions → 129

| | switching action | part no. | circuit drawing | technical drawing | mounting dimension |  |
|--|------------------|------------------|-----------------|-------------------|--------------------|---|
| illuminated-/pushbutton actuator for flush mounting | mom/main | 61-1300.0 | 19 | 10 | 3 | 0,005 |
| | mom | 61-1100.0 | 19 | 10 | 3 | 0,005 |
| | main | 61-1200.0 | 18 | 10 | 3 | 0,005 |

switching action: main = maintained action, mom = momentary action, mom/main = momentary-/maintained action



[marking see page 153](#)

[technical drawing as of page 140. mounting dimensions as of page 145. circuit drawing as of page 150](#)

mushroom pushbutton actuator for flush mounting



recommended accessories:

-  mushroom-head cap → 124
-  front bezel-set round for flush mounting → 126
-  switching element for illuminated-/pushbutton, keylock-/selector switch 2 positions → 129

| | switching action | part no. | circuit drawing | technical drawing | mounting dimension |  |
|--|------------------|------------------|-----------------|-------------------|--------------------|---|
| mushroom pushbutton actuator for flush mounting | mom/main | 61-1300.0 | 3 | 11 | 2 | 0,006 |
| | mom | 61-1100.0 | 3 | 11 | 2 | 0,006 |
| | main | 61-1200.0 | 2 | 11 | 2 | 0,006 |

switching action: main = maintained action, mom = momentary action, mom/main = momentary-/maintained action

[technical drawing as of page 140. mounting dimensions as of page 145. circuit drawing as of page 150](#)

keylock switch actuator with 2 positions for flush mounting



recommended accessories:

-  keylock front bezel → 124
-  front bezel-set for flush mounting → 126
-  switching element for illuminated-/pushbutton, keylock-/selector switch 2 positions → 129

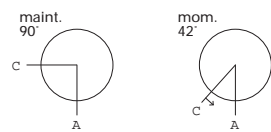

| | switching action | key removable in | part no. | circuit drawing | technical drawing | mounting dimension |  |
|--|------------------|------------------|--------------------|-----------------|-------------------|--------------------|---|
| keylock switch actuator with 2 positions for flush mounting pos. A: basic position pos. C: maintained action standard lock 311, other lock numbers on request | main | A | 61-2201.0/D | 6 | 12 | 3 | 0,003 |
| | | C | 61-2203.0/D | 6 | 12 | 3 | 0,003 |
| | | C + A | 61-2205.0/D | 6 | 12 | 3 | 0,003 |
| pos. A: basic position pos. C: momentary action standard lock 311, other lock numbers on request | mom | A | 61-2101.0/D | 5 | 12 | 3 | 0,003 |

switching action: main = maintained action, mom = momentary action

[description see page 109](#)

[technical drawing as of page 140](#), [mounting dimensions as of page 145](#), [circuit drawing as of page 150](#)

keylock switch actuator 3 positions for flush mounting



recommended accessories:

-  keylock front bezel → 124
-  front bezel-set for flush mounting → 126
-  switching element for keylock-/selector switch 3 positions → 130



| | switching action | key removable in | part no. | circuit drawing | | | technical drawing | | mounting dimension |  |
|---|------------------|------------------|--------------------|-----------------|----|---|-------------------|--|--------------------|---|
| | | | | | | | | | | |
| keylock switch actuator 3 positions for flush mounting pos. C: maintained action pos. A: basic position Pos. B: momentary action standard lock 311, other lock numbers on request | main-0-mom | A | 61-2701.0/D | 10 | 12 | 3 | 0,003 | | | |
| | | C | 61-2703.0/D | 5 | 12 | 3 | 0,003 | | | |
| | | C + A | 61-2705.0/D | 10 | 12 | 3 | 0,003 | | | |
| pos. C: maintained action pos. A: basic position pos. B: maintained action standard lock 311, other lock numbers on request | main-0-main | A | 61-2601.0/D | 11 | 12 | 3 | 0,003 | | | |
| | | A+B | 61-2604.0/D | 11 | 12 | 3 | 0,003 | | | |
| | | B | 61-2602.0/D | 11 | 12 | 3 | 0,003 | | | |
| | | C | 61-2603.0/D | 11 | 12 | 3 | 0,003 | | | |
| | | C + A | 61-2605.0/D | 11 | 12 | 3 | 0,003 | | | |
| | | C+A+B | 61-2607.0/D | 11 | 12 | 3 | 0,003 | | | |
| | | C+B | 61-2606.0/D | 11 | 12 | 3 | 0,003 | | | |
| pos. C: momentary action pos. A: basic position pos. B: maintained action standard lock 311, other lock numbers on request | mom-0-main | A | 61-2801.0/D | 9 | 12 | 3 | 0,003 | | | |
| | | A+B | 61-2804.0/D | 9 | 12 | 3 | 0,003 | | | |
| | | B | 62-2802.0/D | 9 | 12 | 3 | 0,003 | | | |
| pos. C: momentary action pos. A: basic position pos. B: momentary action standard lock 311, other lock numbers on request | mom-0-mom | A | 61-2501.0/D | 8 | 12 | 3 | 0,003 | | | |

switching action: mom = momentary action, main = maintained action, 0 = basic position

[description see page 109](#)

[technical drawing as of page 140. mounting dimensions as of page 145. circuit drawing as of page 150](#)

selector switch actuator 2 positions for flush mounting



recommended accessories:

-  lever for flush mounting → 125
-  front bezel-set for flush mounting → 126
-  incandescent lamp → 132; LED → 133
-  switching element for illuminated-/pushbutton, keylock-/selector switch 2 positions → 129



| | switching action | part no. | circuit drawing | technical drawing | mounting dimension |  |
|---|------------------|------------------|-----------------|-------------------|--------------------|---|
| selector switch actuator 2 positions for flush mounting pos. C: maintained action pos. A: basic position | main | 61-4210.0 | 13 | 13 | 3 | 0,006 |
| pos. C: momentary action pos. A: basic position | mom | 61-4110.0 | 12 | 13 | 3 | 0,006 |

switching action: main = maintained action, mom = momentary action

technical drawing as of page 140, mounting dimensions as of page 145, circuit drawing as of page 150

selector switch actuator 3 positions for flush mounting



recommended accessories:

-  lever for flush mounting → 125
-  front bezel-set for flush mounting → 126
-  incandescent lamp → 132; LED → 133
-  switching element for keylock-/selector switch 3 positions → 130



| | switching action | part no. | circuit drawing | technical drawing | mounting dimension |  |
|--|------------------|------------------|-----------------|-------------------|--------------------|---|
| selector switch actuator 3 positions for flush mounting pos. C: maintained action pos. A: basic position pos. B: maintained action | main-0-main | 61-4610.0 | 17 | 13 | 3 | 0,006 |
| pos. C: maintained action pos. A: basic position pos. B: momentary action | main-0-mom | 61-4710.0 | 16 | 13 | 3 | 0,006 |
| pos. C: momentary action pos. A: basic position pos. B: maintained action | mom-0-main | 61-4810.0 | 15 | 13 | 3 | 0,006 |
| pos. C: momentary action pos. A: basic position pos. B: momentary action | mom-0-mom | 61-4510.0 | 14 | 13 | 3 | 0,006 |

switching action: mom = momentary, main = maintaining, 0 = basic position

technical drawing as of page 140, mounting dimensions as of page 145, circuit drawing as of page 150



at front

lens plastic



| | shape | lens/sup- port | colour | ⌀ 18 x 24 mm part no. | ⌀ 24 x 24 mm part no. | 18 mm dia. part no. | ⌀ 18 x 18 mm part no. | 25 mm dia. part no. |  | |
|---|--------------|---------------------------------------|---------------------------|-----------------------------|-----------------------------|------------------------|-----------------------------|------------------------|---|-------|
| lens plastic matt | con- cave | transpar- ent/trans- lucent | blue | 61-9336.6 | | | 61-9326.6 | | 0,001 | |
| | | | colour- less, clear | 61-9336.7 | | | 61-9326.7 | | 0,001 | |
| | | | green | 61-9336.5 | | | 61-9326.5 | | 0,001 | |
| | | | orange | 61-9336.3 | | | 61-9326.3 | | 0,001 | |
| | | | red | 61-9336.2 | | | 61-9326.2 | | 0,001 | |
| | | | yellow | 61-9336.4 | | | 61-9326.4 | | 0,001 | |
| | flat | transpar- ent/trans- lucent | blue | | | | 61-9311.6 | 61-9321.6 | | 0,001 |
| | | | | 61-9331.6 | 61-9351.6 | | | 61-9642.6 | 0,002 | |
| | | | colour- less, clear | 61-9331.7 | | 61-9311.7 | 61-9321.7 | | | 0,001 |
| | | | | | 61-9351.7 | | | 61-9642.7 | 0,002 | |
| | | | green | 61-9331.5 | 61-9351.5 | 61-9311.5 | 61-9321.5 | | | 0,001 |
| | | | | | | | | 61-9642.5 | 0,002 | |
| | | | orange | | | | 61-9321.3 | | | 0,001 |
| | | | | 61-9331.3 | 61-9351.3 | 61-9311.3 | | 61-9642.3 | 0,002 | |
| | | | red | | | | 61-9321.2 | | | 0,001 |
| | | | | 61-9331.2 | 61-9351.2 | 61-9311.2 | | 61-9642.2 | 0,002 | |
| | | | smoked | 61-9331.1 | | 61-9311.1 | | | | 0,001 |
| | | | | | 61-9351.1 | | 61-9321.1 | | 61-9642.1 | 0,002 |
| | | | yellow | 61-9331.4 | 61-9351.4 | 61-9311.4 | 61-9321.4 | | | 0,001 |
| | | | | | | | | 61-9642.4 | 0,002 | |
| matt (not for film in- sert and LED) | con- cave | translu- cent/ translu- cent | white | 61-9236.9 | | | 61-9226.9 | | 0,001 | |
| | flat | translu- cent/ translu- cent | white | 61-9231.9 | 61-9251.9 | 61-9211.9 | 61-9221.9 | | 0,001 | |
| matt (not for film in- sert and illumina- tion) | con- cave | opaque/ translu- cent | black | 61-9236.0 | | | 61-9226.0 | | 0,001 | |
| | | | grey | 61-9236.8 | | | 61-9226.8 | | 0,001 | |
| | flat | opaque/ translu- cent | black | 61-9231.0 | 61-9251.0 | 61-9211.0 | 61-9221.0 | | 0,001 | |
| | | | grey | 61-9231.8 | 61-9251.8 | 61-9211.8 | 61-9221.8 | | 0,001 | |





lens plastic for flush mounting

| | shape | lens/support | colour | ⌀ 24 x 30 mm part no. | ⌀ 24 x 24 mm part no. | 25 mm dia. part no. |  | |
|---|-------|-------------------------|-------------------|-----------------------------|-----------------------------|------------------------|---|---|
| lens plastic for flush mounting matt | flat | transparent/translucent | blue | 61-9681.6 | 61-9671.6 | 61-9642.6 | 0,001 |  |
| | | | colourless, clear | 61-9681.7 | 61-9671.7 | 61-9642.7 | 0,001 | |
| | | | green | 61-9681.5 | 61-9671.5 | 61-9642.5 | 0,001 | |
| | | | orange | 61-9681.3 | 61-9671.3 | 61-9642.3 | 0,001 | |
| | | | red | 61-9681.2 | 61-9671.2 | 61-9642.2 | 0,001 | |
| | | | smoked | | | 61-9642.1 | 0,001 | |
| matt (not for film insert and LED) | flat | translucent/translucent | white | 61-9781.9 | 61-9771.9 | | 0,001 | |
| matt (not for film insert and illumination) | flat | opaque/translucent | black | 61-9781.0 | 61-9771.0 | | 0,001 | |
| | | | grey | 61-9781.8 | 61-9771.8 | | 0,001 | |



lens metal with window

| | shape | lens | colour | 25 mm dia. part no. |  | |
|------------------------------------|-------|--------------------|---------|------------------------|---|---|
| lens metal with window matt | flat | aluminium anodized | natural | 61-9841.8A | 0,002 |  |

lens metal

| | shape | lens | colour | 25 mm dia. part no. |  | |
|------------------------|-------|--------------------|---------|------------------------|---|---|
| lens metal matt | flat | aluminium anodized | black | 61-9841.0 | 0,002 |  |
| | | | blue | 61-9841.6 | 0,002 | |
| | | | green | 61-9841.5 | 0,002 | |
| | | | natural | 61-9841.8 | 0,002 | |
| | | | red | 61-9841.2 | 0,002 | |
| | | | yellow | 61-9841.4 | 0,002 | |

mushroom-head cap

| | | colour | 32 mm dia. part no. |  | |
|----------------------------------|--------------------|--------|------------------------|---|---|
| mushroom-head cap plastic | mushroom opaque | black | 61-9593.0 | 0,004 |  |
| | | green | 61-9593.5 | 0,004 | |
| | | red | 61-9593.2 | 0,004 | |
| | | yellow | 61-9593.4 | 0,004 | |

keylock front bezel

for keylock switch actuator

| | ⌀ 18 x 24 mm part no. | ⌀ 24 x 24 mm part no. | 18 mm dia. part no. | ⌀ 18 x 18 mm part no. |  | |
|----------------------------|-----------------------------|-----------------------------|------------------------|-----------------------------|---|--|
| keylock front bezel | 61-9230.0 | 61-9250.0 | 61-9210.0 | 61-9220.0 | 0,001 | |

61-9250.0 not for flush mounting

lever



| | colour | colour of bar | part no. |  | |
|--|--------|---------------|------------------|---|---|
| lever with marking dot and transparent bar | black | black, opaque | 52-928.0 | 0,001 |  |
| | | blue | 52-928.60 | 0,001 | |
| | | green | 52-928.50 | 0,001 | |
| | | orange | 52-928.30 | 0,001 | |
| | | red | 52-928.20 | 0,001 | |
| | | white, opaque | 52-928.9 | 0,001 | |
| | | yellow | 52-928.40 | 0,001 | |
| | grey | blue | 52-929.60 | 0,001 | |
| | | green | 52-929.50 | 0,001 | |
| | | grey, opaque | 52-929.8 | 0,001 | |
| | | orange | 52-929.30 | 0,001 | |
| | | red | 52-929.20 | 0,001 | |
| | | white, opaque | 52-929.9 | 0,001 | |
| | | yellow | 52-929.40 | 0,001 | |

lever for flush mounting

| | colour | colour of bar | part no. |  | |
|---|--------|---------------|-------------------|---|---|
| lever for flush mounting with marking dot and transparent bar | black | black, opaque | 61-9028.0 | 0,001 |  |
| | | blue | 61-9028.60 | 0,001 | |
| | | green | 61-9028.50 | 0,001 | |
| | | orange | 61-9028.30 | 0,001 | |
| | | red | 61-9028.20 | 0,001 | |
| | | white, opaque | 61-9028.9 | 0,001 | |
| | | yellow | 61-9028.40 | 0,001 | |
| | grey | blue | 61-9029.60 | 0,001 | |
| | | green | 61-9029.50 | 0,001 | |
| | | grey, opaque | 61-9029.8 | 0,001 | |
| | | orange | 61-9029.30 | 0,001 | |
| | | red | 61-9029.20 | 0,001 | |
| | | white, opaque | 61-9029.9 | 0,001 | |
| | | yellow | 61-9029.40 | 0,001 | |



marking plate

for lens round, 61-9642...

| | front shape | marking plate | colour | part no. |  | |
|---|-------------|---------------|--------|------------------|---|---|
| marking plate clear, of plastic, can be hot pressed | round | transparent | clear | 61-9707.7 | 0,001 |  |

front bezel

for selector switch square front

| | material | colour | \varnothing 24 x 24 mm part no. | \varnothing 26 x 26 mm part no. |  | |
|--------------------|----------|--------|---|---|---|---|
| front bezel | plastic | black | 52-950.0 | 52-952.0 | 0,001 |  |

front bezel-set for flush mounting

| | use | material | colour | ☐ 24 x 30 mm part no. | ☐ 24 x 24 mm part no. | ∅ 25 mm part no. | | | |
|---|----------------------------------|--------------------|------------------|-----------------------------|-----------------------------|---------------------|-------------------|--|-------|
| front bezel-set for flush mounting | illuminated pushbutton/indicator | aluminium | natural | | | 61-9933.0 | 0,006 | | |
| | | anodized | black | | | 61-9933.1 | 0,007 | | |
| | | plastic | aluminium plated | | 61-9931.4 | 61-9930.4 | | | 0,007 |
| | | | black | | 61-9931.0 | 61-9930.0 | 61-9933.10 | | 0,006 |
| | keylock switch | aluminium anodized | natural | | | | 61-9932.0 | | 0,007 |
| | | | black | | | | 61-9932.1 | | 0,007 |
| | | plastic | aluminium plated | | 61-9931.4 | 61-9930.4 | | | 0,007 |
| | | | black | | 61-9931.0 | 61-9930.0 | 61-9932.10 | | 0,006 |
| | selector switch | aluminium anodized | natural | | | | 61-9932.0 | | 0,006 |
| | | | black | | | | 61-9932.1 | | 0,007 |
| | | plastic | | | | 61-9936.0 | 61-9932.10 | | 0,007 |

front ring

for actuator 24 mm dia.

| | material | colour | part no. | | |
|-------------------|--------------------|---------|------------------|-------|--|
| front ring | aluminium anodized | black | 61-9600.0 | 0,003 | |
| | | natural | 61-9600.1 | 0,003 | |

protective front membrane cap

for actuator 24 mm dia.

| | material | colour | part no. | | |
|--------------------------------------|-----------------|-------------|------------------|-------|--|
| protective front membrane cap | silicone nature | transparent | 61-9926.7 | 0,001 | |

protective front membrane cap for flush mounting

| | material | colour | part no. | | |
|---|-----------------|-------------|------------------|-------|--|
| protective front membrane cap for flush mounting for front bezel-set for flush mounting | silicone nature | transparent | 84-9103.7 | 0,001 | |

protective cover

| | ☐ 18 x 24 mm part no. | ☐ 18 x 18 mm part no. | ☐ 24 x 24 mm part no. | technical drawing | | |
|--|-----------------------------|-----------------------------|-----------------------------|-------------------|-------|--|
| protective cover hinged, transparent, with means for sealing | 51-925 | | | 15 | 0,005 | |
| | | | 61-9920.0 | 16 | 0,006 | |
| | | 51-920 | | 14 | 0,005 | |

technical drawing as of page 140

protective cover for flush mounting

| |  |  |  | |
|---|--|---|---|---|
| | 24 x 30 mm part no. | 24 x 24 mm part no. | | |
| protective cover for flush mounting hinged, transparent, with means for sealing | 61-9922.0 | 61-9921.0 | 0,006 |  |

blind plug projecting

| | colour |  |  | 18 mm dia. part no. |  | mounting dimension |  | |
|--|--------|---|---|------------------------|---|--------------------|---|--|
| | | 18 x 24 mm part no. | 24 x 24 mm part no. | | 18 x 18 mm part no. | | | |
| blind plug projecting for mounting hole 16 mm dia. | black | 51-947.0 | 61-9450.0 | 51-949.0 | 51-948.0 | 1 | 0,003 |  |

[mounting dimensions as of page 145](#)

blind plug flat

| | colour |  |  | 28 mm dia. part no. | mounting dimension |  | |
|--|--------|---|---|------------------------|--------------------|---|---|
| | | 24 x 30 mm part no. | 24 x 24 mm part no. | | | | |
| blind plug flat for mounting hole 21 x 21 mm | black | | 61-9451.0 | | 3 | 0,006 |  |
| for mounting hole 21 x 27 mm | black | 61-9452.0 | | | 3 | 0,006 | |
| for mounting hole 22.5 mm dia. | black | | | 704.960.7 | 3 | 0,006 | |

[mounting dimensions as of page 145](#)

EMC key protection cap

| | part no. |  | |
|---|-----------------|---|---|
| EMC key protection cap plastic black, for lock type DOM | 31-985.0 | |  |

spare key

| | part no. |  | |
|--|--------------------|---|---|
| spare key for emergency stop switch with key to release, lock type KABA standard lock 1001, other lock numbers on request | 14-987.1001 | 0,006 |  |
| for keylock switch, lock type DOM standard lock 311, other lock numbers on request | 31-989.311 | 0,006 | |

[description see page 109](#)

master key

| | part no. |  | |
|---|-------------------|---|---|
| master key for lock numbers 311-445 | 31-989.300 | 0,006 |  |



at back

lamp element

| | part no. | circuit drawing |  | |
|--|-------------------|-----------------|---|---|
| lamp element with screw terminal | 61-8006.01 | 1 | 0,005 |  |

[circuit drawing as of page 150](#)

diode element

| | number of diodes | part no. | circuit drawing | components layout |  | |
|--|------------------|-------------------|-----------------|-------------------|---|---|
| diode element with soldering-/plug-in terminal | 1 | 61-8101.02 | 20 | 1 | 0,007 |  |
| | 2 | 61-8102.02 | 21 | 2 | 0,008 | |

[components layouts as of page 146, circuit drawing as of page 150](#)

switching element for illuminated-/pushbutton, keylock-/selector switch 2 positions

| | diode (1N 4007) | switching system | contacts | connection method | material of contacts | part no. | circuit drawing | components layout |  | | |
|---|-----------------|------------------|-----------|-------------------|----------------------|-------------------|-----------------|-------------------|---|----|-------|
| switching element for illuminated-/pushbutton, keylock-/selector switch 2 positions with lamp terminal, max. 250 VAC/6A | - | SA | 1NC | ST/PT | gold/silver | 61-8440.22 | 23 | 3 | 0,007 | | |
| | | | | | silver | 61-8440.12 | 23 | 3 | 0,007 | | |
| | | | 1NC + 1NO | ST/PT | gold/silver | 61-8470.22 | 31 | 15 | 0,007 | | |
| | | | | | silver | 61-8470.12 | 31 | 15 | 0,007 | | |
| | | | 1NC + 2NO | ST/PT | gold/silver | 61-8490.22 | 33 | 16 | 0,007 | | |
| | | | | | silver | 61-8490.12 | 33 | 16 | 0,007 | | |
| | | | 1NO | ST/PT | gold/silver | 61-8410.22 | 28 | 12 | 0,007 | | |
| | | | | | silver | 61-8410.12 | 28 | 12 | 0,007 | | |
| | | | 2NC | ST/PT | gold/silver | 61-8450.22 | 25 | 4 | 0,007 | | |
| | | | | | silver | 61-8450.12 | 25 | 4 | 0,007 | | |
| | | | 2NC + 1NO | ST/PT | gold/silver | 61-8480.22 | 32 | 6 | 0,007 | | |
| | | | | | silver | 61-8480.12 | 32 | 6 | 0,007 | | |
| | | | 2NO | ST/PT | gold/silver | 61-8420.22 | 35 | 13 | 0,007 | | |
| | | | | | silver | 61-8420.12 | 35 | - | 0,007 | | |
| | | | 3NC | ST/PT | gold/silver | 61-8460.22 | 26 | 5 | 0,007 | | |
| | | | | | silver | 61-8460.12 | 26 | 5 | 0,007 | | |
| | | | 3NO | ST/PT | gold/silver | 61-8430.22 | 36 | 14 | 0,007 | | |
| | | | | | silver | 61-8430.12 | 36 | 14 | 0,007 | | |
| T | 1NC | SCH | silver | 61-8640.11 | 22 | - | 0,008 | | | | |
| | | | 1NO | SCH | silver | 61-8610.11 | 28 | 13 | 0,008 | | |
| 2 | SA | 1NO + 2D | ST/PT | silver | 61-8212.12 | 29 | 17 | 0,007 | | | |
| | | | | gold/silver | 61-8212.22 | 29 | 17 | 0,007 | | | |
| with lamp terminal, max. 42 VAC/DC/100 mA | - | T | 1NC | ST/PT | gold | 61-8640.37 | 23 | 10 | 0,008 | | |
| | | | | | 1NC + 1NO | ST/PT | gold | 61-8670.37 | 31 | 9 | 0,008 |
| | | | | | 1NO | ST/PT | gold | 61-8610.37 | 28 | 7 | 0,008 |
| | | | | | 2NC | ST/PT | gold | 61-8650.37 | 25 | 11 | 0,008 |
| | | | | | 2NO | ST/PT | gold | 61-8620.37 | 35 | 8 | 0,008 |
| with lamp terminal, max.250 VAC/5A | - | T | 1NC | ST/PT | silver | 61-8640.17 | 23 | 10 | 0,008 | | |
| | | | | | 1NC + 1NO | ST/PT | silver | 61-8670.17 | 31 | 9 | 0,008 |
| | | | | | 1NO | ST/PT | silver | 61-8610.17 | 28 | 7 | 0,008 |
| | | | | | 2NC | ST/PT | silver | 61-8650.17 | 25 | 11 | 0,008 |
| | | | | | 2NO | ST/PT | silver | 61-8620.17 | 35 | 8 | 0,008 |
| without lamp terminal, max. 250 VAC/6 A | - | T | 1NC | SCH | silver | 61-8645.11 | 22 | - | 0,008 | | |
| | | | | | 1NC + 1NO | SCH | silver | 61-8675.11 | 30 | - | 0,008 |
| | | | | | 1NO | SCH | silver | 61-8615.11 | 27 | - | 0,008 |
| | | | | | 2NC | SCH | silver | 61-8655.11 | 24 | - | 0,008 |
| | | | | | 2NO | SCH | silver | 61-8625.11 | 34 | - | 0,008 |



switching system: SA = snap-action switching element, T = slow-make switching element
 connection method: SCH = screw terminal, ST/PT = soldering-/plug-in terminal
 contacts: NC = normally closed, NO = normally open
 components layouts as of page 146, circuit drawing as of page 150

switching element for emergency stop switch

| | switching system | contacts | connection method | material of contacts | part no. | circuit drawing | components layout | |
|---|------------------|-----------|-------------------|----------------------|-------------------|-----------------|-------------------|-------|
| switching element for emergency stop switch max. 250 VAC/5A | T | 1NC | ST/PT | silver | 61-8745.17 | 37 | 19 | 0,008 |
| | | 1NC + 1NO | ST/PT | silver | 61-8775.17 | 39 | 18 | 0,008 |
| | | 2NC | ST/PT | silver | 61-8755.17 | 38 | 20 | 0,008 |
| max. 250 VAC/6A | T | 1NC | SCH | silver | 61-8745.11 | 37 | - | 0,008 |
| | | 1NC + 1NO | SCH | silver | 61-8775.11 | 39 | - | 0,008 |
| | | 2NC | SCH | silver | 61-8755.11 | 38 | - | 0,008 |
| max. 42 VAC/DC/100 mA | T | 1NC | ST/PT | gold | 61-8745.37 | 37 | 19 | 0,008 |
| | | 1NC + 1NO | ST/PT | gold | 61-8775.37 | 39 | 18 | 0,008 |
| | | 2NC | ST/PT | gold | 61-8755.37 | 38 | 20 | 0,008 |



switching system: T = slow-make switching element
 connection method: SCH = screw terminal, ST/PT = soldering-/plug-in terminal
 contacts: NC = normally closed, NO = normally open
 components layouts as of page 146, circuit drawing as of page 150

switching element for keylock-/selector switch 3 positions

| | switching system | contacts | connection method | material of contacts | part no. | circuit drawing | components layout | |
|--|------------------|-----------|-------------------|----------------------|-------------------|-----------------|-------------------|-------|
| switching element for keylock-/selector switch 3 positions with lamp terminal, max. 250 VAC/6A | SA | 1NC + 1NO | ST/PT | gold/silver | 61-8574.22 | 31 | 23 | 0,008 |
| | | | | silver | 61-8574.12 | 31 | 23 | 0,008 |
| | | 2NC | ST/PT | gold/silver | 61-8550.22 | 25 | 21 | 0,008 |
| | | | | silver | 61-8550.12 | 25 | 21 | 0,008 |
| with lamp terminal, max. 42 VAC/DC/100 mA | T | 1NC + 1NO | ST/PT | gold | 61-8770.37 | 31 | 24 | 0,008 |
| | | | | gold | 61-8750.37 | 25 | 26 | 0,008 |
| | | 2NO | ST/PT | gold | 61-8720.37 | 35 | 25 | 0,008 |
| with lamp terminal, max. 250 VAC/5A | T | 1NC + 1NO | ST/PT | silver | 61-8770.17 | 31 | 24 | 0,008 |
| | | | | silver | 61-8750.17 | 25 | 26 | 0,008 |
| | | 2NO | ST/PT | silver | 61-8720.17 | 35 | 25 | 0,008 |
| without lamp terminal, max. 250 VAC/6 A | T | 1NC + 1NO | SCH | silver | 61-8775.11 | 31 | - | 0,008 |
| | | | | silver | 61-8755.11 | 24 | - | 0,008 |
| | | 2NO | SCH | silver | 61-8725.11 | 35 | - | 0,008 |



switching system: SA = snap-action switching element, T = slow-make switching element
 connection method: SCH = screw terminal, ST/PT = soldering-/plug-in terminal
 contacts: NC = normally closed, NO = normally open
 components layouts as of page 146, circuit drawing as of page 150

flasher element

| | operation voltage | connection method | part no. |  | |
|-----------------|-----------------------|-------------------|-------------------|---|---|
| flasher element | 12 VAC/DC - 28 VAC/DC | ST | 61-8000.05 | |  |

connection method: ST = soldering terminal
 typical applications see page 151
 circuit drawing as of page 150

PCB plug-in base

for plug-in terminal

| | for | pin orientation | part no. | components layout |  | |
|---|-------------------------------|-----------------|------------------|-------------------|---|--|
| PCB plug-in base 13.1 mm dia. x 12.8 mm | indicator complete | axial | 61-9820.1 | 27 | 0,002 |  |
| 15 mm x 23 mm x 9.4 mm | slow-make switching element | axial | 61-9823 | 29 | 0,002 | |
| 17.7 mm x 23.6 mm x 10.9 mm | snap-action switching element | axial | 61-9821.1 | 28 | 0,003 | |

components layouts as of page 146



multi-plug housing

| | part no. |  | |
|---|----------------|---|---|
| multi-plug housing for snap-action switching element, max. 6 connections possible | 61-9830 | 0,002 |  |

cable shoe



| | connection method | part no. |  | |
|------------|--|-----------------|---|---|
| cable shoe | plug in terminal 2,8 x 0,5 mm | 31-946 | 0,001 |  |
| | plug-in terminal 2,8 x 0,5 mm for multi-plug housing | 51-943.1 | 0,001 | |

terminal cover

| | use | part no. |  | |
|----------------|-----------------------------------|------------------|---|---|
| terminal cover | for indicator element | 61-9831.2 | 0,001 |  |
| | for snap-action switching element | 61-9830.2 | 0,002 | |

for illumination

incandescent lamp

| | voltage/current | part no. |  | |
|--------------------------------------|------------------|---------------------------------|---|---|
| incandescent lamp base MG T 1 3/4 | 6 AC/DC/125 mA | 10-1306.1349 (41-963.0) | 0,001 |  |
| | 6.3 AC/DC/200 mA | 10-1307.1369 (31-963.0) | 0,001 | |
| | 12 AC/DC/75 mA | 10-1309.1309 (41-963.1) | 0,001 | |
| | 14 AC/DC/80 mA | 10-1310.1319 (31-963.1) | 0,001 | |
| | 18 AC/DC/40 mA | 10-1311.1249 (41-963.2) | 0,001 | |
| | 24 AC/DC/35 mA | 10-1312.1229 (41-963.3) | 0,001 | |
| | 28 AC/DC/30 mA | 10-1313.1209 (41-963.4) | 0,001 | |
| | 28 AC/DC/40 mA | 10-1313.1249 (31-963.2) | 0,001 | |
| | 36 AC/DC/20 mA | 10-1316.1179 (41-963.36) | 0,001 | |
| | 36 AC/DC/30 mA | 10-1316.1209 (31-963.5) | 0,001 | |
| | 48 AC/DC/20 mA | 10-1319.1179 (41-963.5) | 0,001 | |
| | 48 AC/DC/25 mA | 10-1319.1199 (31-963.3) | 0,001 | |
| | 60 AC/DC/20 mA | 10-1320.1179 (31-963.4) | 0,001 | |

| LED | | | | | |
|------------------------------|-----------------|-------------------|---------------------------------|---------------------------------|---|
| | number of chips | voltage/current | colour | part no. |  |
| LED base MG T1 3/4 | 6 chips | 6 VDC/45 mA | green | 10-5306.3255 (31-968.05) | 0,001 |
| | | | red | 10-5306.3252 (31-968.02) | 0,001 |
| | | | yellow | 10-5306.3254 (31-968.04) | 0,001 |
| | | 12 VDC/30 mA | green | 10-5309.3205 (31-968.15) | 0,001 |
| | | | red | 10-5309.3202 (31-968.12) | 0,001 |
| | | | yellow | 10-5309.3204 (31-968.14) | 0,001 |
| | | 24 VAC/DC/12.5 mA | green | 10-5312.1115 (22-996.51) | 0,001 |
| | | | red | 10-5312.1112 (22-996.21) | 0,001 |
| | | | yellow | 10-5312.1114 (22-996.41) | 0,001 |
| | | 24 VDC/14 mA | green | 10-5312.3135 (31-968.25) | 0,001 |
| | | | red | 10-5312.3132 (31-968.22) | 0,001 |
| | | | yellow | 10-5312.3134 (31-968.24) | 0,001 |
| | | 28 VAC/DC/12.5 mA | green | 10-5313.1115 (22-997.51) | 0,001 |
| | | | red | 10-5313.1112 (22-997.21) | 0,001 |
| | | | yellow | 10-5313.1114 (22-997.41) | 0,001 |
| | | 28 VDC/14 mA | green | 10-5313.3135 (22-997.5) | 0,001 |
| | | | red | 10-5313.3132 (22-997.2) | 0,001 |
| | | | yellow | 10-5313.3134 (22-997.4) | 0,001 |
| | 48 VDC/12 mA | green | 10-5319.3105 (31-968.45) | 0,001 | |
| | | red | 10-5319.3102 (31-968.42) | 0,001 | |
| | | yellow | 10-5319.3104 (31-968.44) | 0,001 | |
| | 8 chips | 6 VDC/48 mA | green | 10-6306.3265 (61-994.5) | 0,001 |
| | | | red | 10-6306.3262 (61-994.2) | 0,001 |
| | | | yellow | 10-6306.3264 (61-994.4) | 0,001 |
| | | 12 VDC/24 mA | green | 10-6309.3185 (61-995.5) | 0,001 |
| | | | red | 10-6309.3182 (61-995.2) | 0,001 |
| | | | yellow | 10-6309.3184 (61-995.4) | 0,001 |
| | | 24 VDC/12 mA | green | 10-6312.3105 (61-996.5) | 0,001 |
| | | | red | 10-6312.3102 (61-996.2) | 0,001 |
| | | | yellow | 10-6312.3104 (61-996.4) | 0,001 |
| | | 28 VDC/12 mA | green | 10-6313.3105 (96-997.5) | 0,001 |
| | | | red | 10-6313.3102 (61-997.2) | 0,001 |
| | | | yellow | 10-6313.3104 (61-997.4) | 0,001 |
| | 1 chip | 24 VDC/14 mA | white | 10-2312.3139 | 0,001 |
| | | 28 VDC/14 mA | white | 10-2313.3139 | 0,001 |



capacitor

for lamp voltage reduction

| | value | part no. |  |
|---|-----------------|-----------------|---|
| capacitor use with 60 VAC/20 mA, 50 Hz lamp voltage | 230 VAC/0.27 µF | 02-917.0 | 0,004 |



Wire in accordance with local electrical safety regulations.

series resistor

for lamp voltage reduction

| | value | part no. |  |
|---|-------------------|-----------------|---|
| series resistor use with 60 VAC/20 mA lamp rating | 110 V/2.7 kOhm | 02-904.0 | 0,003 |
| | 125 V/3.3 kOhm | 02-904.1 | 0,003 |
| | 145 V/4.7 kOhm | 02-904.3 | 0,003 |
| | 230-240 V/10 kOhm | 02-904.7 | 0,003 |



Wire in accordance with local electrical safety regulations.

terminal plate empty

for fitting with series resistors and capacitors

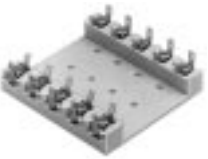
| | no. of spaces | part no. |  | |
|-----------------------------|---------------|-----------------|---|---|
| terminal plate empty | 5 spaces | 02-912.1 | 0,025 |  |
| | 10 spaces | 02-912.2 | 0,045 | |
| | 15 spaces | 02-912.3 | 0,090 | |
| | 20 spaces | 02-912.4 | 0,095 | |

terminal plate with capacitor

| | value | no. of components | part no. |  | |
|---|------------------------|-------------------|------------------|---|---|
| terminal plate with capacitor use with 60 VAC/20 mA lamp rating | 0,27 µF/230 VAC/60 VAC | 5 spaces | 02-914.10 | 0,045 |  |
| | | 10 spaces | 02-914.20 | 0,135 | |
| | | 15 spaces | 02-914.30 | 0,135 | |
| | | 20 spaces | 02-914.40 | 0,180 | |



terminal plate with series resistor

| | value | no. of components | part no. |  | |
|---|----------------------|-------------------|------------------|---|--|
| terminal plate with series resistor use with 60 VAC/20 mA lamp rating | 2.7 kOhm/110/60 V | 5 spaces | 02-913.10 | 0,040 |  |
| | | 10 spaces | 02-913.20 | 0,075 | |
| | | 15 spaces | 02-913.30 | 0,115 | |
| | | 20 spaces | 02-913.40 | 0,155 | |
| | 3.3 kOhm/125/60 V | 5 spaces | 02-913.11 | 0,040 | |
| | | 10 spaces | 02-913.21 | 0,075 | |
| | | 15 spaces | 02-913.31 | 0,115 | |
| | | 20 spaces | 02-913.41 | 0,155 | |
| | 10 kOhm/230-240/60 V | 5 spaces | 02-913.17 | 0,040 | |
| | | 10 spaces | 02-913.27 | 0,075 | |
| | | 15 spaces | 02-913.37 | 0,115 | |
| | | 20 spaces | 02-913.47 | 0,155 | |



Wire in accordance with local electrical safety regulations.

for emergency stop switch

label for emergency stop switch

| | marking | 43 mm dia. part no. |  | |
|--|-----------------|------------------------|---|---|
| label for emergency stop switch 43 mm dia., yellow | ARRET D'URGENCE | 61-9970.3 | 0,002 |  |
| | Emergency Stop | 61-9970.2 | 0,002 | |
| | NOT-AUS | 61-9970.1 | 0,002 | |
| | without marking | 61-9970.0 | 0,002 | |

protective shroud for emergency stop switch

| | part no. |  | |
|--|----------------|---|---|
| protective shroud for emergency stop switch aluminium anodized, yellow | 61-9965 | |  |

enclosure for emergency stop switch

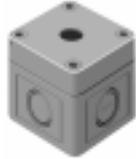

| | part no. |  kg | |
|--|------------------|--|---|
| enclosure for emergency stop switch with mounting hole size 16 mm dia. colour RAL 1004. dimensions: 65 mm long, 65 mm wide, 57 mm high front protection IP 65 | 61-9480.4 | 0,079 |  |

cable gland PG11

| | part no. | | |
|-------------------------|------------------|--|--|
| cable gland PG11 | 61-9481.8 | | |

assembling

anti-twisting ring



| | part no. |  kg | |
|---|-----------------|--|---|
| anti-twisting ring for key- and selector switch | 51-910.0 | 0,002 |  |

reducing ring



for 16 mm pushbuttons in mounting hole 22.5 mm dia.

| | part no. |  kg | |
|--|----------------|--|---|
| reducing ring only for use of front dimension: 24 x 24 mm/24 mm dia. | 61-9960 | 0,003 |  |

tool-set

| | part no. |  kg | |
|--|--------------------|--|---|
| tool-set consists of lens remover, lamp remover, mounting tool, dismantling tool | K61-999.100 | |  |

lens remover



| | use | part no. |  kg | |
|---------------------|---|------------------|--|---|
| lens remover | for 24 x 24 mm, 25 mm dia. front and overhanging lenses | 61-9730.0 | 0,011 |  |
| | for standard lenses | 02-905 | 0,011 | |

lamp/LED remover

| | part no. |  | |
|------------------|------------------|---|---|
| lamp/LED remover | 61-9740.0 | 0,003 |  |

dismantling tool for lens

for dismantling of lens and lensholder

| | part no. |  | |
|--|----------------|---|---|
| dismantling tool for standard lens | 51-938 | 0,027 |  |
| dismantling tool for lens for flush mounting | 61-9832 | 0,024 | |

dismantling tool for switching element

| | part no. |  | |
|--|------------------|---|---|
| dismantling tool for switching element | 61-9711.0 | 0,004 |  |

mounting tool

| | part no. |  | |
|--|---------------|---|---|
| mounting tool for tightening (or loosening) fixing nuts | 01-907 | 0,020 |  |

cable shoe remover

| | part no. |  | |
|--|-----------------|---|---|
| cable shoe remover for removing the connector from the multi-plug housing | 51-943.9 | 0,001 |  |

actuator with snap-action switching element**switching system**

Self-cleaning, double-break, snap-action switching elements (contact gap 2 x 0.5 mm).

The elements can be supplied with the following choice of switching functions:

for illuminated pushbutton or switch actuator with 2 positions: max. 3 normally open contacts, max. 3 normally closed contacts or combined

switch actuator with 3 positions:

max. 2 normally open contacts, max. 2 normally closed contacts or combined

The switching element can be easily snapped to or dismantled from the actuator.

material**actuator case**

polyetherimide PEI, self-extinguishing

front bezel

polyetherimide PEI and chromium plated

front ring

of aluminium

lenses

polymethylmethacrylat PMMA, polycarbonate PC, aluminium (mushroom head cap: polyamide PA)

material of contacts

gold-plated silver or silver

switching element

diallyl phthalate DAP, self-extinguishing, polysulfone PSU

mechanical characteristics**actuating force**

measured at the lens of the illuminated pushbutton:
2.7-10 N, depending on the number of switching elements

actuating torque

measured at the lever or key of the selector-or keylock switch:
2.5 - 10 Ncm, depending on the number of switching elements

actuating travel

illuminated pushbutton :3 mm

switch actuator with 2 positions:

1 x ca. 42° deflection momentary action

1 x ca. 90° deflection maintained action

switch actuator with 3 positions:

2 x ca. 42° deflection momentary action

2 x ca. 90° deflection maintained action

ambient air temperature

-25°C to +55°C

for indicators and illuminated pushbuttons mounted as a block, make sure the heat can escape freely (as per DIN IEC 68-)

connection method

universal terminal (soldering-/plug-in terminal):

max. wire diameter: 2 of 1 mm

max. wire cross-section of stranded cable: 1 x 0.75 mm² soldering-/plug-in terminal: 2.8 x 0.5 mm

degree of protection

indicator, illuminated pushbutton, emergency stop switch, selector- and keylock switch: front IP 65

switching element IP 40

soldering terminal IP 20

mechanical life

as per IEC 512-5-6

momentary action 2 mio. cycles of operation

maintained action 1 mio. cycles of operation

keylock switch 50000 cycles of operation

selector switch 100000 cycles of operation

rebound time

<= 5ms

resistance to shock

(single impacts, semi-sinusoidal)

50 g, 11 ms as per IEC 512-4-3, IEC 68-2-27

resistance to vibration

(sinusoidal)

10 g, at 10- 2000- 10 Hz, amplitude 0.75 mm as per IEC 512-4-4, IEC 68-2-6

storage temperature

-40°C to + 85°C

(as per DIN IEC 68-)

electrical characteristics**continuous thermal current I_{th2}**

5 A

The maximum current in continuous operation and at ambient temperature not exceeding the quoted maximum values.

electric strength

as per VDE 0630 (IEC 512-2-11)

2500 VAC, 50 Hz, 1 min between all terminals and earth

electrostatic breakdown value

>= 11 KV (keylock switch)

protection class

II

rated current

6 A

rated voltage

250 VAC/VDC

switch rating

gold-/silver contact:

min. 5 VAC/10 mA

max. 250 VAC/6 A

silver contact:

min. 20 VAC/500 mA

max. 250 VAC/6 A

switch rating AC, cos. φ 0,7:

| | | | |
|-----------------------|---------|---------|---------|
| rated service voltage | 250 VAC | 125 VAC | 110 VAC |
|-----------------------|---------|---------|---------|

| | | | |
|-----------------------|-----|-----|-----|
| rated service current | 2 A | 3 A | 3 A |
|-----------------------|-----|-----|-----|

switch rating DC, L:R=30 ms:

| | | | | |
|------------------------|-----|-----|----|--------|
| rated service voltage: | 220 | 110 | 60 | 24 VDC |
|------------------------|-----|-----|----|--------|

| | | | | |
|-----------------------|--|--|--|--|
| rated service current | | | | |
|-----------------------|--|--|--|--|

| | | | | |
|------------|-----|-----|-----|-------|
| resistive: | 0.5 | 0.7 | 2.0 | 6.0 A |
|------------|-----|-----|-----|-------|

| | | | | |
|-----------------------|--|--|--|--|
| rated service current | | | | |
|-----------------------|--|--|--|--|

| | | | | |
|-----------|------|-----|-----|-------|
| L:R=30ms: | 0.15 | 0.3 | 0.7 | 2.0 A |
|-----------|------|-----|-----|-------|

volume resistance

starting value (initial) for:

gold-/silver contact <= 50 mΩ as per IEC 512-2-test 4

silver contact <= 100 mΩ as per IEC 512-2-test 5

Technical Data

rules

IEC 1058 EN 61 058

approvals

- SEV 250 VAC/6 A
- CSA 300 VAC
- UR 250 VAC/6 A
- VDE 250 VAC/6 A
- German Lloyd

actuator with slow-make switching element

switching system

Self-cleaning, double-break, snap-action switching elements (contact gap 2 x 1.5 mm).

The elements can be supplied with the following choice of switching functions:

for illuminated pushbutton or switch actuator with 2 positions:
max. 2 normally open contacts, max. 2 normally closed contacts or combined

for switch actuator with 3 positions:
max. 2 normally open contacts, max. 2 normally closed contacts or combined

The switching element can be easily snapped to or dismantled from the actuator.

material

actuator case

polyetherimide PEI, self-extinguishing

front bezel

polyetherimide PEI and chromium plated

front ring

of aluminium

lenses

polymethylmethacrylat PMMA, polycarbonate PC, aluminium (mushroom head cap: polyamide PA)

material of contacts

gold (low level), silver

switching element

polyamide PA, polysulfone PSU

mechanical characteristics

actuating force

measured at the lens of the illuminated pushbutton:
3.5-20 N, depending on the number of switching elements

measured at the mushroom head cap of the emergency stop switch:
max. 65 N

actuating torque

measured at the lever or key of the selector-or keylock switch:
4-16 Ncm, depending on the number of switching elements
emergency stop switch: 15 Ncm

actuating travel

illuminated pushbutton :3 mm

emergency stop switch:10 mm

switch actuator with 2 positions:

1 x ca. 42° deflection momentary action

1 x ca. 90° deflection maintained action

switch actuator with 3 positions:

2 x ca. 42° deflection momentary action

2 x ca. 90° deflection maintained action

ambient air temperature

-25°C to +55°C

for indicators and illuminated pushbuttons mounted as a block ,
make sure the heat can escape freely
(as per DIN IEC 68-)

connection method

universal terminal (soldering-/plug-in terminal):

max. wire diameter: 2 of 1 mm

max. wire cross-section of stranded cable: 1 x 0.75 mm²

soldering-/plug-in terminal: 2.8 x 0.5 mm

screw terminal:

max. wire cross-section of stranded cable: 1 x 1 mm²

degree of pollution

3

degree of protection

indicator, illuminated pushbutton, emergency stop switch, selector-
and keylock switch: front IP 65

switching element IP 40

screw terminal IP 20 as per VDE 0106 Teil 100

mechanical life

as per IEC 512-5-6

momentary action 2 mio. cycles of operation

maintained action 1 mio. cycles of operation

keylock switch 50000 cycles of operation

selector switch 100000 cycles of operation

emergency stop switch 50000 cycles of operation

rebound time

<= 2 ms

resistance to shock

(single impacts, semi-sinusoidal)

50 g, 11 ms as per IEC 512-4-3, IEC 68-2-27

resistance to vibration

(sinusoidal)

10 g, at 10- 2000- 10 Hz, amplitude 0.75 mm as per IEC 512-4-4,
IEC 68-2-6

storage temperature

-40°C to + 85°C

(as per DIN IEC 68-)

electrical characteristics

continuous thermal current Ith₂

universal terminal 5 A

screw terminal 10 A

The maximum current in continuous operation and at ambient temperature not exceeding the quoted maximum values.

electric strength

as per VDE 0630 (IEC 512-2-11)

4000 VAC, 50 Hz, 1 between all terminals and earth

electrical life

switching element of emergency stop switch 6'050 cycles of operation

Technical Data

electrostatic breakdown value

>= 11 KV (keylock switch)

max. permissible rated current

10 A gL

over voltage category

III

protection class

II

rated current

6 A

rated voltage

300 V

switch rating

gold contact (universal terminal, Low Level):

min. 100 μ V/10 μ A

max. 42 VAC/100 mA;

silver contact (universal terminal):

min. 20 VAC/10 mA

max. 250 VAC/5 A

silver contact (screw terminal):

min. 20 VAC/10 mA

max. 250 VAC/6 A

switch rating AC:

| | | | | |
|-----------------------|-----|-----|----|--------|
| rated service voltage | 250 | 120 | 60 | 24 VAC |
|-----------------------|-----|-----|----|--------|

| | | | | |
|-----------------------------|-----|-----|-----|-----|
| rated service current AC 13 | 3 A | 5 A | 6 A | 6 A |
|-----------------------------|-----|-----|-----|-----|

| | | | | |
|------------------------------|-----|-----|-----|-----|
| rated service current AC 14* | 2 A | 3 A | 4 A | 5 A |
|------------------------------|-----|-----|-----|-----|

| | | | | |
|-------------------------------|-----|--|--|--|
| rated service current AC 15** | 2 A | | | |
|-------------------------------|-----|--|--|--|

*only for emergency stop switch with universal terminal

**only for emergency stop switch with screw terminal

switch rating DC :

| | | | | |
|------------------------|-----|-----|----|--------|
| rated service voltage: | 240 | 110 | 60 | 24 VDC |
|------------------------|-----|-----|----|--------|

| | | | | |
|----------------------------------|-----|-----|-----|-------|
| rated service current resistive: | 0,5 | 0,7 | 2,0 | 6,0 A |
|----------------------------------|-----|-----|-----|-------|

| | | | | |
|----------------------------------|-----|-----|-----|-------|
| rated service current L:R=30 ms: | 0.2 | 0.4 | 1.0 | 2.0 A |
|----------------------------------|-----|-----|-----|-------|

volume resistance

starting value (initial) for:

gold contact <= 50 m Ω as per IEC 512-2-test 4

silver contact <= 50 m Ω as per IEC 512-2-test 5

rules

IEC 947-5-1 EN 60 947

approvals

- SEV 250 VAC
- CSA
- UL
- VDE

actuator with flasher element

material

actuator case

polyetherimide PEI, self-extinguishing

lenses

polymethylmethacrylat PMMA, polycarbonate PC

mechanical characteristics

ambient air temperature

0°C to + 45°C

(as per DIN IEC 68-)

connection method

soldering terminal 2.8 x 0.8 mm

electrical characteristics

flashing frequency

1 Hz \pm 0.25 Hz

illumination

incandescent lamp: 14 V, 80 mA or 28 V, 40 mA

Multi-LED: 12 V, 25 mA or 24 V, 12.5 mA

making cycle

1:1

operating voltage

AC or DC

12 - 10% or 28 V + 10%

technical drawing

1 indicator complete

page 111



2 indicator-flasher-actuator

page 111

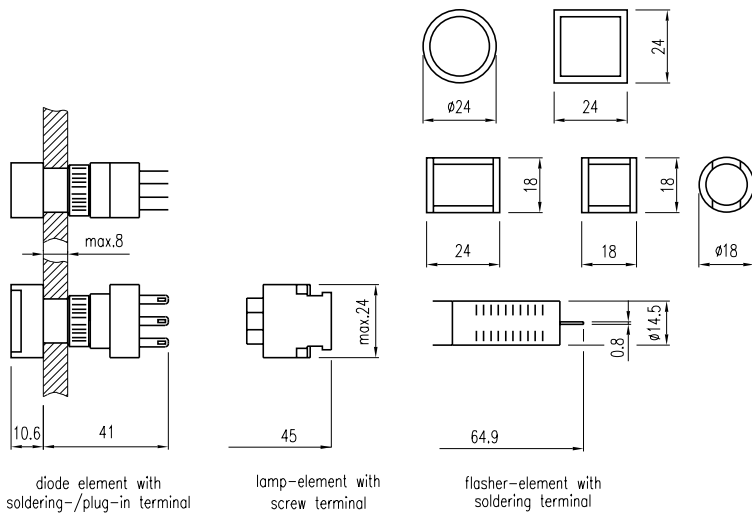

diode element with soldering-/plug-in terminal

lamp-element with screw terminal

flasher-element with soldering terminal

3 illuminated-/pushbutton actuator

page 112



snap-action switching element with soldering-/plug-in terminal

slow-make switching element with soldering-/plug-in terminal

slow-make switching element with screw terminal

4 emergency stop switch actuator foolproof page 112

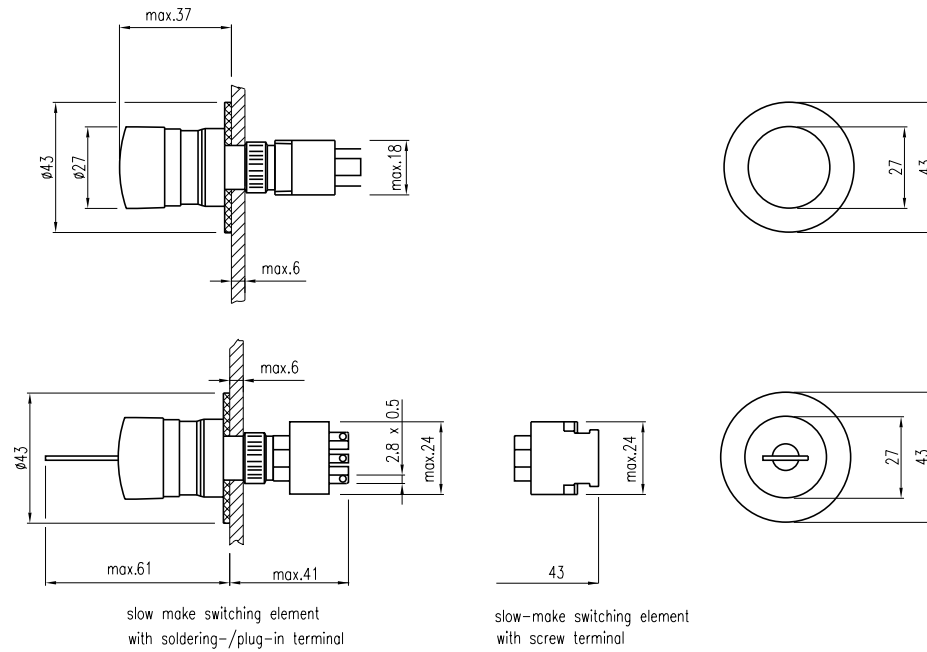

5 pushbutton actuator with mushroom-head cap page 113

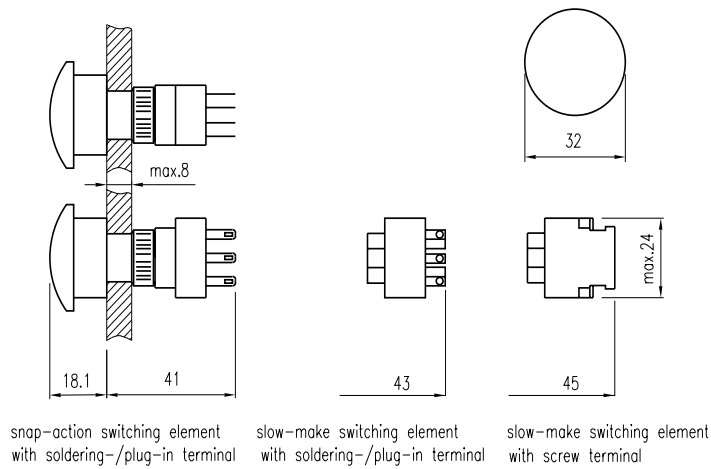

6 keylock switch actuator 2 positions, keylock switch actuator 3 positions page 113, 114



7 selector switch actuator 2 positions, selector switch actuator 3 positions page 115, 116



8 indicator complete for flush mounting page 117



9 indicator-/flasher-actuator for flush mounting

page 117

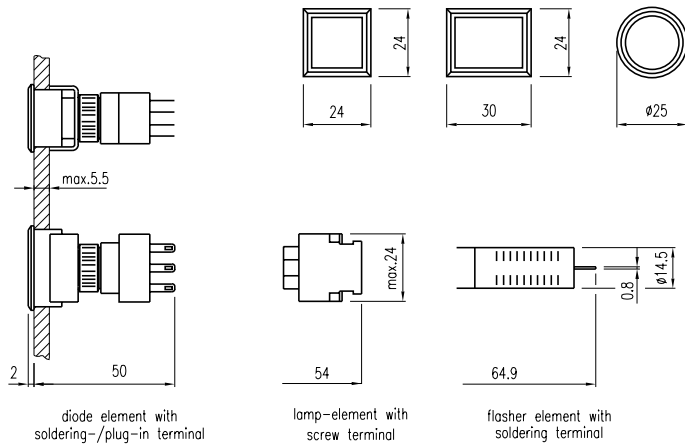

10 illuminated-/pushbutton actuator for flush mounting

page 118



11 mushroom pushbutton actuator for flush mounting

page 118



12 keylock switch actuator with 2 positions for flush mounting, keylock switch actuator 3 positions for flush mounting
page 119, 120



13 selector switch actuator 2 positions for flush mounting, selector switch actuator 3 positions for flush mounting
page 121, 122



14 protective cover
page 126



15 protective cover
page 126



16 protective cover
page 126



mounting dimension

1 indicator complete, indicator-flasher-actuator, illuminated-/pushbutton actuator, keylock switch actuator 2 positions, keylock switch actuator 3 positions, selector switch actuator 2 positions, selector switch actuator 3 positions, blind plug projecting
page 111, 112, 113, 114, 115, 116, 127



2 emergency stop switch actuator foolproof, pushbutton actuator with mushroom-head cap, mushroom pushbutton actuator for flush mounting
page 112, 113



3 indicator complete for flush mounting, indicator-flasher-actuator for flush mounting, illuminated-/pushbutton actuator for flush mounting, keylock switch actuator with 2 positions for flush mounting, keylock switch actuator 3 positions for flush mounting, selector switch actuator 2 positions for flush mounting, selector switch actuator 3 positions for flush mounting, blind plug flat
page 117,118,119,120, 121, 122, 127

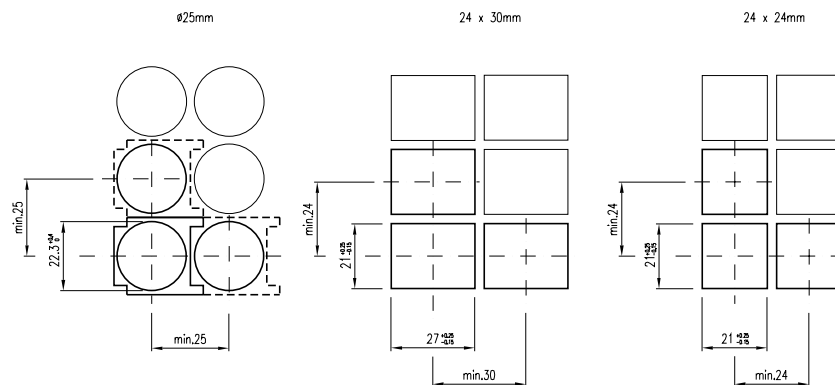

components layouts

1 diode element

page 128

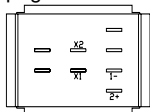

2 diode element

page 128

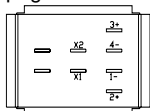

3 switching element for illuminated-/pushbutton, keylock-/selector switch 2 positions

page 129

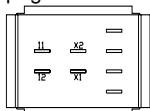

4 switching element for illuminated-/pushbutton, keylock-/selector switch 2 positions

page 129

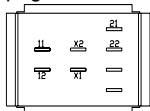

5 switching element for illuminated-/pushbutton, keylock-/selector switch 2 positions

page 129

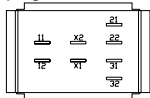

6 switching element for illuminated-/pushbutton, keylock-/selector switch 2 positions

page 129

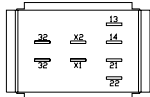

7 switching element for illuminated-/pushbutton, keylock-/selector switch 2 positions

page 129

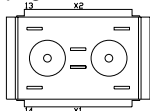

8 switching element for illuminated-/pushbutton, keylock-/selector switch 2 positions

page 129

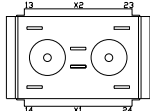

9 switching element for illuminated-/pushbutton, keylock-/selector switch 2 positions

page 129

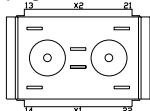

10 switching element for illuminated-/pushbutton, keylock-/selector switch 2 positions
page 129



11 switching element for illuminated-/pushbutton, keylock-/selector switch 2 positions
page 129

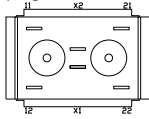

12 switching element for illuminated-/pushbutton, keylock-/selector switch 2 positions
page 129

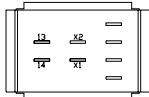

13 switching element for illuminated-/pushbutton, keylock-/selector switch 2 positions
page 129

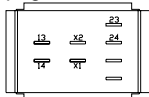

14 switching element for illuminated-/pushbutton, keylock-/selector switch 2 positions
page 129

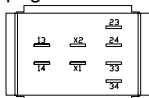

15 switching element for illuminated-/pushbutton, keylock-/selector switch 2 positions
page 129

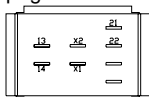

16 switching element for illuminated-/pushbutton, keylock-/selector switch 2 positions
page 129

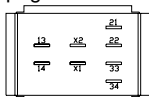

17 switching element for illuminated-/pushbutton, keylock-/selector switch 2 positions
page 129

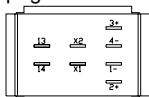

18 switching element for emergency stop switch
page 130



19 switching element for emergency stop switch
page 130



20 switching element for emergency stop switch
page 130



21 switching element for keylock-/selector switch 3 positions
page 130



22 switching element for keylock-/selector switch 3 positions
page 130



23 switching element for keylock-/selector switch 3 positions
page 130



24 switching element for keylock-/selector switch 3 positions
page 130

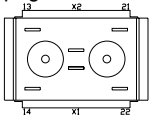

25 switching element for keylock-/selector switch 3 positions
page 130

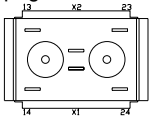

26 switching element for keylock-/selector switch 3 positions
page 130

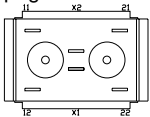

27 PCB plug-in base
page 131

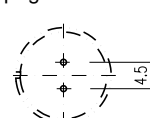

28 PCB plug-in base
page 131



29 PCB plug-in base
page 131



| | circuit drawing | | circuit drawing |
|----|-----------------|----|-----------------|
| 1 | | 21 | |
| 2 | | 22 | |
| 3 | | 23 | |
| 4 | | 24 | |
| 5 | | 25 | |
| 6 | | 26 | |
| 7 | | 27 | |
| 8 | | 28 | |
| 9 | | 29 | |
| 10 | | 30 | |
| 11 | | 31 | |
| 12 | | 32 | |
| 13 | | 33 | |
| 14 | | 34 | |
| 15 | | 35 | |
| 16 | | 36 | |
| 17 | | 37 | |
| 18 | | 38 | |
| 19 | | 39 | |
| 20 | | | |

With indicators and illuminated pushbuttons equipped with diodes, the user is able to perform a lamp check or wire an alarm circuit simply with a considerable saving of space.

lamp check

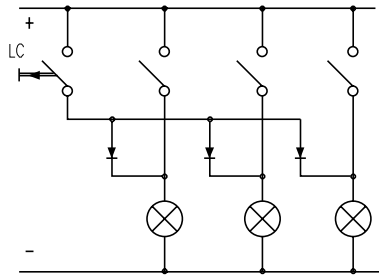

lamp check with blocking diodes

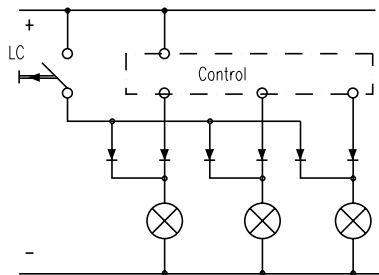

alarm circuit from fault
annunciating system

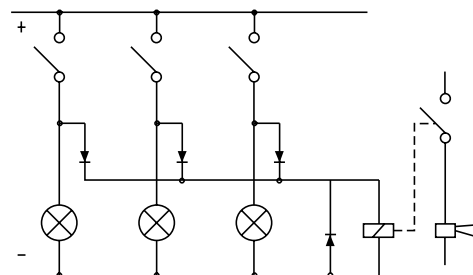

lamp check and alarm circuit

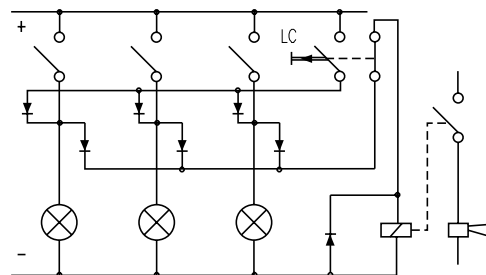

lamp check and alarm circuit with
only one diode and AC voltage

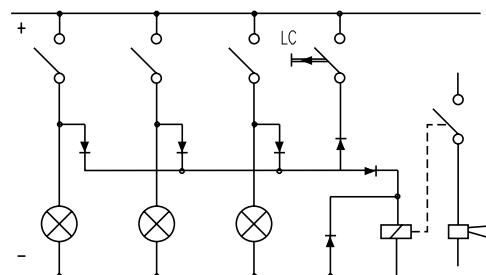

LC = lamp check

Flasher element



1. Continuous light

1. Engraving

Typefaces

In addition to the most commonly used world languages (see DIN 1451) with close spacing, the following typefaces are available: Scandinavian, Slavian, Greek, Russian.

Coloured filling of engraving

Specify whether engraving should be on the diffuser, or on the lens.
Specify the infill colour, character height and the text or symbol orientation.

Symbols

A list of the symbols available can be supplied on request.

2. Hot stamping

For large batches it is worth while to have the lettering produced by hot stamping.

Typefaces

For letters and figures, typefaces with 2,5 mm, 3 mm and 4 mm are available.

Symbols

A list of the symbols available can be supplied on request.

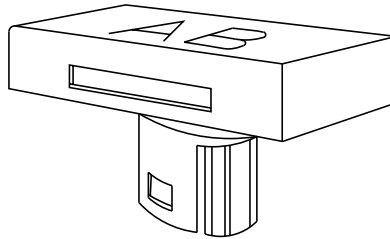

Important!

Before engraving, check the position of the illuminated pushbutton or indicator

| Height of letters mm | (switch) lens | (18 x 24) 15,3 x 21,5 mm | | | | | | (Ø 18) Ø 15,8 mm | | | (18 x 18) 15,3 x 15,3 mm | | |
|-------------------------|------------------|-----------------------------|-------------------------------|-------------------------------|-------------------|-------------------------------|-------------------------------|---------------------|-------------------------------|-------------------------------|-----------------------------|-------------------------------|-------------------------------|
| | | Horizontal mounting | | | Vertical mounting | | | Number of lines | Number of letters per line | Number of letters per line | Number of lines | Number of letters per line | Number of letters per line |
| h | s | Number of lines | Number of letters per line | Number of letters per line | Number of lines | Number of letters per line | Number of letters per line | | | | | | |
| 2,5 | 0,4 | 4 | 11 | 12 | 5 | 7-8 | 8 | 3 | 6 | 6 | 4 | 7-8 | 8 |
| 3 | 0,4 | 3 | 9-10 | 10-11 | 4 | 6-7 | 7 | 2 | 5 | 6 | 3 | 6-7 | 7 |
| 4 | 0,5 | 2 | 7 | 7-8 | 3 | 4-5 | 5 | 2 | 3 | 4 | 2 | 4-5 | 5 |
| 5 | 0,5 | 2 | 5-6 | 6 | 2 | 3-4 | 4 | 1 | 2 | 3 | 2 | 3-4 | 4 |
| 6 | 0,6 | 1 | 4-5 | 5 | 2 | 3 | 3-4 | 1 | 2 | 2 | 1 | 3 | 3-4 |
| 8 | 0,6 | 1 | 3-4 | 3-4 | 1 | 2-3 | 2-3 | 1 | 2 | 2 | 1 | 2-3 | 2-3 |
| Film dimension | | □ max. 12,7 x 18,7 mm | | | | | | Ø 12,8 mm | | | □ 12,7 x 12,7 mm | | |

3. Film inserts

Instead of using engraving, the lenses can be fitted with transparent film inserts. For this purpose, though, it is advisable to use transparent lenses. When a smoked lens is used, the lettering does not become visible until the lamp lights.



Film dimensions

16,9x16,9 mm
11,9x11,9 mm
max 11,9x18,0 mm

Film thickness

0.2 mm

Important!

Before engraving, check the position of the illuminated pushbutton or indicator.

| Height of letters | | Thickness of letters | | Number of lines | | Number of letters per line | | Number of letters per line | | Number of lines | | Number of letters per line | | Number of letters per line | | Number of lines | | Number of letters per line | | Number of letters per line | | |
|-----------------------|-----|----------------------|---------|-----------------|---------|----------------------------|---------|----------------------------|---------|-----------------|---------|----------------------------|---------|----------------------------|---------|-----------------|---------|----------------------------|---------|----------------------------|---------|-----|
| h | s | (caps) | (small) | (caps) | (small) | (caps) | (small) | (caps) | (small) | (caps) | (small) | (caps) | (small) | (caps) | (small) | (caps) | (small) | (caps) | (small) | (caps) | (small) | |
| 2,5 | 0,4 | 3 | 6 | 6 | 4 | 9 | 10 | 4 | 12 | 13 | 5 | 8-9 | 9 | 4 | 8-9 | 9 | 4 | 8-9 | 9 | 4 | 8-9 | 9 |
| 3 | 0,4 | 2 | 5 | 6 | 3 | 7-8 | 9 | 3 | 10-11 | 11-12 | 4 | 7-8 | 8 | 3 | 7-8 | 8 | 3 | 7-8 | 8 | 3 | 7-8 | 8 |
| 4 | 0,5 | 2 | 3 | 4 | 2 | 4-5 | 5 | 2 | 7 | 8 | 3 | 4-5 | 5 | 2 | 4-5 | 5 | 2 | 4-5 | 5 | 2 | 4-5 | 5 |
| 5 | 0,5 | 1 | 2 | 3 | 2 | 4 | 4-5 | 2 | 5-6 | 6 | 2 | 4 | 4-5 | 2 | 4 | 4-5 | 2 | 4 | 4-5 | 2 | 4 | 4-5 |
| 6 | 0,6 | 1 | 2 | 3 | 1 | 4 | 4 | 1 | 4-5 | 5 | 2 | 3 | 3-4 | 1 | 4 | 4 | 1 | 4 | 4 | 1 | 4 | 4 |
| 8 | 0,6 | 1 | 2 | 2 | 1 | 2 | 2 | 1 | 3-4 | 3-4 | 1 | 2-3 | 2-3 | 1 | 2-3 | 2-3 | 1 | 2-3 | 2-3 | 1 | 2-3 | 2-3 |
| Film dimension | | | | | | ☐ 16,9 x 16,9 mm | | | | ☐ 15,1 x 21 mm | | | | ☐ 15,1 x 15,1 mm | | | | | | | | |



Компания «ЭлектроПласт» предлагает заключение долгосрочных отношений при поставках импортных электронных компонентов на взаимовыгодных условиях!

Наши преимущества:

- Оперативные поставки широкого спектра электронных компонентов отечественного и импортного производства напрямую от производителей и с крупнейших мировых складов;
- Поставка более 17-ти миллионов наименований электронных компонентов;
- Поставка сложных, дефицитных, либо снятых с производства позиций;
- Оперативные сроки поставки под заказ (от 5 рабочих дней);
- Экспресс доставка в любую точку России;
- Техническая поддержка проекта, помощь в подборе аналогов, поставка прототипов;
- Система менеджмента качества сертифицирована по Международному стандарту ISO 9001;
- Лицензия ФСБ на осуществление работ с использованием сведений, составляющих государственную тайну;
- Поставка специализированных компонентов (Xilinx, Altera, Analog Devices, Intersil, Interpoint, Microsemi, Aeroflex, Peregrine, Syfer, Eurofarad, Texas Instrument, Miteq, Cobham, E2V, MA-COM, Hittite, Mini-Circuits, General Dynamics и др.);

Помимо этого, одним из направлений компании «ЭлектроПласт» является направление «Источники питания». Мы предлагаем Вам помощь Конструкторского отдела:

- Подбор оптимального решения, техническое обоснование при выборе компонента;
- Подбор аналогов;
- Консультации по применению компонента;
- Поставка образцов и прототипов;
- Техническая поддержка проекта;
- Защита от снятия компонента с производства.



Как с нами связаться

Телефон: 8 (812) 309 58 32 (многоканальный)

Факс: 8 (812) 320-02-42

Электронная почта: org@eplast1.ru

Адрес: 198099, г. Санкт-Петербург, ул. Калинина, дом 2, корпус 4, литера А.